



**US Army Corps  
of Engineers**  
Waterways Experiment  
Station

Technical Report REMR-CS-53  
April 1997

*Repair, Evaluation, Maintenance, and Rehabilitation Research Program*

# **Applications of Roller-Compacted Concrete in Rehabilitation and Replacement of Hydraulic Structures**

*by James E. McDonald, Nancy F. Curtis*



Approved For Public Release; Distribution Is Unlimited

19970630 023



Prepared for Headquarters, U.S. Army Corps of Engineers

**DTIC QUALITY INSPECTED 1**

The following two letters used as part of the number designating technical reports of research published under the Repair, Evaluation, Maintenance, and Rehabilitation (REMR) Research Program identify the problem area under which the report was prepared:

	<u>Problem Area</u>		<u>Problem Area</u>
CS	Concrete and Steel Structures	EM	Electrical and Mechanical
GT	Geotechnical	EI	Environmental Impacts
HY	Hydraulics	OM	Operations Management
CO	Coastal		

The contents of this report are not to be used for advertising, publication, or promotional purposes. Citation of trade names does not constitute an official endorsement or approval of the use of such commercial products.



# **Applications of Roller-Compacted Concrete in Rehabilitation and Replacement of Hydraulic Structures**

by James E. McDonald, Nancy F. Curtis

U.S. Army Corps of Engineers  
Waterways Experiment Station  
3909 Halls Ferry Road  
Vicksburg, MS 39180-6199

**Final report**

Approved for public release; distribution is unlimited

Prepared for **U.S. Army Corps of Engineers  
Washington, DC 20314-1000**

Under **Work Unit 32639**



**US Army Corps  
of Engineers**  
Waterways Experiment  
Station

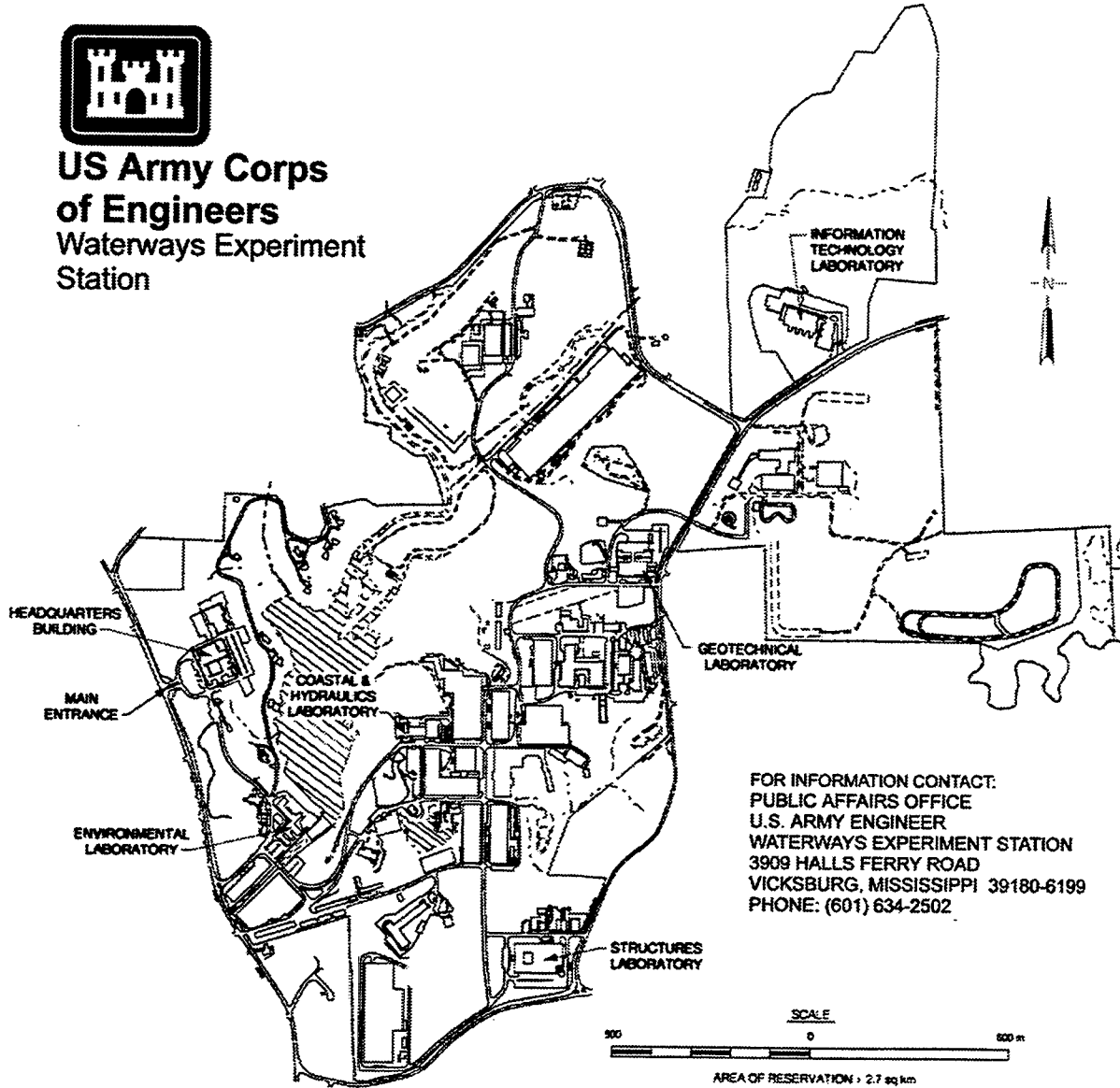

**Waterways Experiment Station Cataloging-in-Publication Data**

McDonald, J. E. (James E.)

Applications of roller-compacted concrete in rehabilitation and replacement of hydraulic structures / by James E. McDonald, Nancy F. Curtis ; prepared for U.S. Army Corps of Engineers.

184 p. : ill. ; 28 cm. — (Technical report ; REMR-CS-53)

Includes bibliographic references.

1. Roller compacted concrete. 2. Hydraulic structures — Maintenance and repair. I. Curtis, Nancy F. II. United States. Army. Corps of Engineers. III. U.S. Army Engineer Waterways Experiment Station. IV. Repair, Evaluation, Maintenance, and Rehabilitation Research Program. V. Title. VI. Series: Technical report (U.S. Army Engineer Waterways Experiment Station) ; REMR-CS-53.

TA7 W34 no.REMR-CS-53

# Contents

---

Preface .....	x
1—Introduction .....	1
Background .....	1
Objective .....	2
Scope .....	2
2—Case Histories .....	3
Dam Rehabilitation .....	3
Ocoee No. 2 Dam .....	3
Toutle River Dam .....	6
Brownwood Country Club Dam .....	8
Kerrville Ponding Dam .....	11
Spring Creek Dam .....	12
Addicks and Barker Dams .....	16
Comanche Trail Lake Dam .....	28
Bishop Intake No. 2 .....	30
Boney Falls Dam .....	34
Tellico Dam .....	39
Gibraltar Dam .....	42
Kemmerer City Dam .....	47
Nickajack Dam .....	50
Ringtown No. 5 Dam .....	58
Santa Cruz Dam .....	63
Thompson Park Dam No. 3 .....	69
Ashton Dam .....	70
Lake Lenape Dam .....	72
Saltlick Dam .....	75
White Meadow Lake Dam .....	80
Butler Reservoir and Soil Erosion Dams .....	80
Camp Dyer Diversion Dam .....	83
Horsethief Dam .....	86
Meadowlark Dam .....	90
North Potato Creek Dam .....	90
Philipsburg Dam No. 3 .....	94
Ponca Dam .....	95

Rosebud Dam .....	98
Littlerock Dam .....	101
South Prong Dam .....	111
Dam Replacement .....	117
Cedar Falls Dam .....	117
Dryden Dam .....	121
Marmot Dam .....	125
Quail Creek South Dam .....	129
Victoria Dam .....	132
Christian E. Siegrist Dam .....	138
Miscellaneous Applications .....	143
Tarbela Dam .....	143
Chena Floodway Sill .....	153
New Cumberland Lock .....	154
Northloop Detention Dams .....	154
Cache Creek Weir .....	159
3—Conclusions and Recommendations .....	163
References .....	165

## List of Tables

---

Table 1.	Summary of Dam Rehabilitation Case Studies .....	4
Table 2.	Summary of Dam Replacement Case Studies .....	118
Table 3.	Summary of Miscellaneous Case Studies .....	144

## List of Figures

---

Figure 1.	Cross section showing rehabilitation plan for Ocoee Dam ...	6
Figure 2.	Downstream face of Ocoee Dam with RCC overtopping protection .....	7
Figure 3.	Failed gabion spillway, Toutle River .....	7
Figure 4.	RCC compaction on the downstream slope, Toutle River Dam .....	9
Figure 5.	Cross section of modified spillway, Brownwood Country Club Dam .....	9

Figure 6.	Layout of RCC batch plant at Brownwood Country Club Dam . . . . .	10
Figure 7.	Completed RCC spillway, Brownwood Country Club Dam . . . . .	11
Figure 8.	Overtopping damage to service spillway, Kerrville Ponding Dam . . . . .	13
Figure 9.	Plan for RCC gravity buttress, Kerrville Ponding Dam . . . . .	14
Figure 10.	RCC placing and compaction, Kerrville Ponding Dam . . . . .	14
Figure 11.	Condition of the RCC following overtopping, Kerrville Ponding Dam . . . . .	15
Figure 12.	RCC placement, Spring Creek Dam . . . . .	17
Figure 13.	Completed emergency spillway, Spring Creek Dam . . . . .	17
Figure 14.	Paving sequence for placing RCC at Addicks and Barker Dams . . . . .	19
Figure 15.	RCC paver connected to a bulldozer for paving slopes at Barker Dam . . . . .	19
Figure 16.	RCC spalling along a joint, Addicks Dam . . . . .	21
Figure 17.	Buckling blowups in RCC at Addicks Dam . . . . .	22
Figure 18.	Typical separation of crest and slope at Addicks and Barker Dams . . . . .	23
Figure 19.	Longitudinal crack in the RCC armorplating at Addicks Dam . . . . .	24
Figure 20.	Removal of spalled RCC and replacement with new concrete, Barker Dam . . . . .	24
Figure 21.	Typical spall repair, Addicks and Barker Dams . . . . .	25
Figure 22.	Typical full-depth repair of RCC at Addicks and Barker Dams . . . . .	26
Figure 23.	Typical lane separation repair at Addicks and Barker Dams . . . . .	27
Figure 24.	Joint sealant placed in RCC crack at Barker Dam . . . . .	28
Figure 25.	Typical RCC crack repair at Barker Dam . . . . .	29
Figure 26.	Plan for placing RCC on Comanche Trail Lake Dam . . . . .	31
Figure 27.	Drawing of RCC spillway constructed at Bishop Intake No. 2 . . . . .	33
Figure 28.	Completed RCC spillway at Bishop Intake No. 2 . . . . .	34
Figure 29.	Cross section of the overflow spillway and RCC embankment protection at Boney Falls Dam . . . . .	35

Figure 30.	RCC spillway section with erodible earth-fill crest, Boney Falls Dam . . . . .	36
Figure 31.	Placement of RCC adjacent to existing concrete core, Boney Falls Spillway . . . . .	37
Figure 32.	The completed RCC emergency spillway at Boney Falls . . .	39
Figure 33.	Emergency spillway, Tellico Reservoir Saddle Dam . . . . .	40
Figure 34.	Portion of completed spillway, Tellico Reservoir Saddle Dam . . . . .	41
Figure 35.	Cross section and plan of RCC buttress, Gibraltar Dam . . . .	44
Figure 36.	Layout of drainage system, Gibraltar Dam . . . . .	45
Figure 37.	Smaller dozers at work in narrow placement area near the top of the buttress at Gibraltar Dam . . . . .	46
Figure 38.	Slope compactor being used at Gibraltar Dam . . . . .	46
Figure 39.	Gibraltar Dam after being strengthened with an RCC buttress . . . . .	47
Figure 40.	RCC emergency spillway at Kemmerer City Dam . . . . .	49
Figure 41.	Right embankment modifications, Nickajack Dam . . . . .	51
Figure 42.	RCC trial mixture proportioned for Nickajack Dam . . . . .	53
Figure 43.	Results of strength tests on RCC mixtures, Nickajack Dam . . . . .	53
Figure 44.	Principal RCC mixtures used at Nickajack Dam . . . . .	54
Figure 45.	Spreading and compaction of RCC at Nickajack Dam . . . . .	55
Figure 46.	Typical form for downstream face at Nickajack Dam . . . . .	55
Figure 47.	Downstream face of RCC section, Nickajack Dam . . . . .	56
Figure 48.	Tarp used for curing RCC at Nickajack Dam . . . . .	56
Figure 49.	Spillway profile and section, Ringtown No. 5 Dam . . . . .	59
Figure 50.	Typical lift plan, Ringtown No. 5 Dam . . . . .	61
Figure 51.	Sequence for step construction, Ringtown No. 5 Dam . . . . .	62
Figure 52.	Completed steps and wall, Ringtown No. 5 Dam . . . . .	62
Figure 53.	Completed spillway, Ringtown No. 5 Dam . . . . .	63
Figure 54.	Section showing original Santa Cruz Dam and modifications . . . . .	65
Figure 55.	Downstream face of Santa Cruz Dam after modifications . . .	68
Figure 56.	Cross section of Ashton Dam . . . . .	70
Figure 57.	Completed overflow spillway, Ashton Dam . . . . .	71



Figure 58.	Rehabilitation plan for Lake Lenape Dam . . . . .	73
Figure 59.	RCC trial mixture proportions and test results, Lake Lenape Dam . . . . .	74
Figure 60.	Modification plan for Saltlick Dam . . . . .	77
Figure 61.	Spillway construction details at Saltlick Dam . . . . .	78
Figure 62.	Detail showing RCC-concrete joint at Saltlick Dam . . . . .	79
Figure 63.	RCC modifications, Butler Reservoir Dam . . . . .	81
Figure 64.	Cross section of modifications for Camp Dyer Diversion Dam . . . . .	84
Figure 65.	Details for RCC buttress at Camp Dyer Diversion Dam . . . . .	85
Figure 66.	RCC placement at Horsethief Dam . . . . .	88
Figure 67.	Lift surface covered with blankets and face covered with topsoil, Horsethief Dam . . . . .	88
Figure 68.	Cross section of RCC spillway design for North Potato Creek Dam . . . . .	92
Figure 69.	Section through Ponca Dam spillway . . . . .	97
Figure 70.	RCC placement operations, Ponca Dam spillway . . . . .	98
Figure 71.	Completed spillway, Ponca Dam . . . . .	99
Figure 72.	Modification plan for Rosebud Dam . . . . .	100
Figure 73.	RCC being discharged from ready-mix truck onto left abutment at Rosebud Dam . . . . .	102
Figure 74.	Seeded topsoil placed over RCC overtopping protection at Rosebud Dam . . . . .	102
Figure 75.	Rehabilitation plan for Littlerock Dam . . . . .	104
Figure 76.	Cross section of maximum nonoverflow section, Littlerock Dam . . . . .	105
Figure 77.	Crest detail, nonoverflow section, Littlerock Dam . . . . .	106
Figure 78.	Spillway section, Littlerock Dam . . . . .	107
Figure 79.	Spillway crest detail, Littlerock Dam . . . . .	108
Figure 80.	Concrete conveyor and discharge pipes, Littlerock Dam . . . . .	110
Figure 81.	Compacting RCC around the existing buttresses, Littlerock Dam . . . . .	110
Figure 82.	Partially completed rehabilitation of Littlerock Dam . . . . .	112
Figure 83.	Downstream face of Littlerock Dam following rehabilitation . . . . .	112
Figure 84.	Layout of South Prong Dam . . . . .	114

Figure 85.	RCC emergency spillway, South Prong Dam . . . . .	115
Figure 86.	Precast concrete beams used to form downstream steps, South Prong Dam . . . . .	116
Figure 87.	Layout of Cedar Falls Project . . . . .	119
Figure 88.	Cross section of RCC gravity dam constructed at Cedar Falls Project . . . . .	120
Figure 89.	Results of compressive strength tests on laboratory-compacted RCC cylinders for Dryden Dam . . . . .	122
Figure 90.	Typical cross section, Dryden Dam . . . . .	123
Figure 91.	Barrier cross section, Dryden Dam . . . . .	123
Figure 92.	Results of compressive strength tests on field-compacted RCC cylinders, Dryden Dam . . . . .	125
Figure 93.	Typical section, Marmot Dam . . . . .	126
Figure 94.	RCC delivered to Marmot Dam by a pivoting conveyor system . . . . .	128
Figure 95.	RCC on downstream face of Marmont Dam prior to placing conventional concrete facing . . . . .	129
Figure 96.	Maximum cross section, Quail Creek South Dam . . . . .	131
Figure 97.	RCC placement, Quail Creek South Dam . . . . .	133
Figure 98.	Conventional concrete placement on the upstream face of the cutoff trench, Quail Creek South Dam . . . . .	133
Figure 99.	Typical cross section, Victoria Dam . . . . .	134
Figure 100.	Contraction and control joints, Victoria Dam . . . . .	136
Figure 101.	RCC density and compressive strength, Victoria Dam . . . . .	138
Figure 102.	RCC shear strengths, Victoria Dam . . . . .	138
Figure 103.	Cross section through spillway at Siegrist Dam . . . . .	139
Figure 104.	Overall view of project site, Siegrist Dam . . . . .	141
Figure 105.	RCC placement, Siegrist Dam . . . . .	141
Figure 106.	Repair plan for Tunnel No. 2 intake, Tarbela Dam . . . . .	146
Figure 107.	Mixing tower for RCC used to repair Tunnel No. 2 intake at Tarbela Dam . . . . .	148
Figure 108.	Service spillway repairs at Tarbela Dam . . . . .	150
Figure 109.	RCC placement at the service spillway, Tarbela Dam . . . . .	152
Figure 110.	RCC placement at the Chena Floodway Sill . . . . .	153
Figure 111.	RCC being dumped into a drop pipe at the top of New Cumberland Lock . . . . .	155

Figure 112.	RCC delivered to the lock floor via a drop pipe at New Cumberland Lock . . . . .	155
Figure 113.	RCC being compacted, New Cumberland Lock . . . . .	156
Figure 114.	Cross section of typical Northloop flood detention dams . . . .	156
Figure 115.	Layout of Cache Creek Settling Basin . . . . .	160
Figure 116.	Section through RCC weir constructed at Cache Creek Settling Basin . . . . .	161
Figure 117.	Upstream and downstream face details, Cache Creek Settling Basin . . . . .	162

# Preface

---

The study reported herein was authorized by Headquarters, U.S. Army Corps of Engineers (HQUSACE), under Civil Works Research Work Unit 32639, "Repair and Rehabilitation of Dams," for which Mr. James E. McDonald, Structures Laboratory (SL), U.S. Army Engineer Waterways Experiment Station (WES), is the Principal Investigator. This work unit is part of the Concrete and Steel Structures Problem Area of the Repair, Evaluation, Maintenance, and Rehabilitation (REMR) Research Program.

The REMR Technical Monitor is Mr. M. K. Lee, HQUSACE. Dr. Tony C. Liu (CERD-C) is the REMR Coordinator at the Directorate of Research and Development, HQUSACE. Mr. Harold C. Tohlen (CECW-O) and Dr. Liu serve as the REMR Overview Committee. Mr. William F. McCleese, WES, is the REMR Program Manager. Mr. McDonald is the Problem Area Leader for Concrete and Steel Structures. This report was prepared by Mr. McDonald, Concrete and Materials Division (CMD), SL, and Ms. Nancy F. Curtis, Contractor, under the general supervision of Dr. Paul F. Mlakar, Chief, CMD, and Mr. Bryant Mather, Director, SL.

Copyright permission to reprint material in this document was requested and granted, and courtesy credit lines are indicative of this material.

At the time of publication of this report, Director of WES was Dr. Robert W. Whalin. Commander was COL Bruce K. Howard, EN.

*The contents of this report are not to be used for advertising, publication, or promotional purposes. Citation of trade names does not constitute an official endorsement or approval of the use of such commercial products.*

# 1 Introduction

---

## Background

The American Concrete Institute (ACI) defines roller-compacted concrete (RCC) as concrete compacted by roller compaction; concrete that, in its unhardened state, will support a roller while being compacted. RCC is no-slump concrete in the unhardened state that is transported, placed, and compacted with earth and rockfill construction equipment. It differs from granular soil cement, which may be placed with similar methods, in that it contains coarse aggregate and develops hardened properties similar to conventionally placed concrete. RCC encompasses a wide range of mixtures with properties that are primarily dependent on the quality of materials used, the cementitious materials content, the degree of compaction, and the degree of control exercised (ACI 207 1994).

Although RCC was primarily developed for rapid, economical construction of new dams (Hansen and Reinhardt 1991), it has been used extensively in recent years in remediation projects at existing concrete and embankment dams. These applications include increasing existing spillway capacities, construction of new service and emergency spillways, overtopping protection, seismic strengthening, and dam replacement. The basic properties of RCC (high strength, low permeability, and high erosion resistance compared to nonstabilized materials), together with low cost, rapid and relatively simple construction methods, and proven performance, make it particularly attractive for remediation of hydraulically deficient embankment dams.

Case histories of selected RCC applications in rehabilitation and replacement of dams and related hydraulic structures are contained herein. These case histories were compiled to show the range of previous applications and to illustrate typical design and construction practices in repair and rehabilitation of hydraulic structures with RCC.

## **Objective**

The objective of this study was to prepare case histories on selected projects that illustrate current practices in rehabilitation and replacement of dams and related hydraulic structures with RCC.

## **Scope**

Input on applications of RCC in rehabilitation and replacement of dams and related hydraulic structures was obtained through (a) discussions with engineers and contractors, (b) discussions with project personnel, and (c) literature searches. The information was checked for completeness, and in some cases, follow-up contact was made to obtain missing data or to clarify information.

For each of the case studies included in this report, an attempt was made to obtain (a) a description of the project, (b) the cause and extent of the deficiency that necessitated repair or replacement, (c) design details, (d) mixture proportions, (e) descriptions of materials, equipment, and placement procedures, (f) costs, and (g) RCC performance to date. Based on a review and analysis of these case histories, recommendations for future applications of RCC were developed.

## 2 Case Histories

---

### Dam Rehabilitation

RCC applications in dam rehabilitation projects include erosion and scour protection for the crest, slopes, and stilling basins of embankment and rock-fill timber crib dams subject to overtopping; increased hydraulic capacity for emergency and service spillways; breach repair; and construction of downstream gravity sections for seismic strengthening and increased sliding stability of concrete gravity, arch, and buttress dams. The following case histories describe selected applications of RCC in dam remediation projects. Table 1 is a summary of these case histories.

#### Ocoee No. 2 Dam

The Ocoee No. 2 Dam is located on the Ocoee River near Benton, TN. Constructed in 1912 and 1913, the dam was designed as a companion to Ocoee No. 1; the two projects together produced the first electric service in Chattanooga.

Ocoee No. 2 Dam is a rock-fill timber crib dam. It is 137 m (450 ft) long and 9 m (30 ft) high. Water diverted by the dam flows through a 7.4-km- (4.6-mile-) long wooden flume to the 21,000-watt powerhouse. The project produces about 135 million kilowatt hours per year, enough to supply approximately 9,000 homes (Buttrey 1983).

In 1976 power generation had to be suspended because of deterioration of several of the steel and concrete trestles that support the flume, portions of the flume, and the downstream face of the timber crib dam. Rehabilitation began in 1980. Because of its historical significance and uniqueness, the flume was rebuilt of wood supported by concrete footings. Riprap was placed on the downstream face of the rock-fill timber crib dam. After flash floods washed out the riprap four times, the Tennessee Valley Authority (TVA) decided to place RCC over the riprap (Hansen 1989b). Approximately 3,440 cu m (4,500 cu yd) of RCC was placed in 2.4-m- (8-ft-) wide, 0.3-m- (1-ft-) thick lifts over the riprap that had

**Table 1**  
**Summary of Dam Rehabilitation Case Studies**

RCC Completed	Name of Dam	Height, m (ft)	Length, m (ft)	RCC Volume, m <sup>3</sup> (yd <sup>3</sup> )	Cement + Fly Ash, kg/m <sup>3</sup> (lb/yd <sup>3</sup> )	Unit Cost, \$/m <sup>3</sup> (\$/yd <sup>3</sup> )	Application
1980	Ocoee No. 2	9.1 (30)	137.2 (450)	3,400 (4,450)			Overtopping protection, rock-filled timber crib dam
1980	Toutle River	11.6 (38)		13,760 (18,000)	297 + 0 (500 + 0)		91.4-m (300-ft) wide replacement spillway
1984	Brownwood Country Club	5.8 (19)		1,070 (1,400)	178 IP (300 IP)	\$54.93 (\$42.00)	Embankment overtopping protection
1985	Kerrville Ponding	6.4 (21)	182.9 (600)	16,820 (22,000)	119 + 0 (200 + 0)		Downstream gravity section
1986	Spring Creek	16.2 (53)	173.7 (570)	3,700 (4,840)	133 + 0 (225 + 0)	\$49.05 (\$37.50)	Embankment overtopping protection
1988	Addicks and Barker	14.8 (48.5) 11.1 (36.5)	18,593 (61,000) 21,946 (72,000)	43,350 (56,700)	173 + 145 (292 + 244)	\$103.32 (\$78.99)	Embankment overtopping protection, crest & slopes
1988	Comanche Trail	6.1 (20)	198.1 (650)	4,970 (6,500)	147 + 37 (248 + 63)	\$50.89 (\$38.91)	Breach repair; embankment overtopping protection, crest & downstream slope
1989	Bishop Intake No. 2	12.5 (41)	134.1 (440)	3,058 (4,000)	116 + 116 (195 + 195)		New emergency spillway
1989	Boney Falls	7.6 (25)	1,829 (6,000)	3,708 (4,850)	88 + 109 (149 + 184)	\$75.86 (\$58.00)	New emergency spillway
1989	Tellico			14,985 (19,600)	148 + 113 (250 + 190)	\$52.00 (\$40.00)	New emergency spillway
1990	Gibraltar	59.4 (195)	182.9(600)	71,100 (93,000)	89 + 53 (150 + 90)		Downstream buttress for seismic strengthening
1990	Kemmerer City	9.1 (30)	259 (850)	3,135 (4,100)	248 + 0 (418 + 0)	\$98.17 (\$75.06)	New emergency spillway
1990	Nickajack	24.7 (81)	1,148 (3,767)	80,280 (105,000)	85 + 119 (143 + 200)	\$45.78 (\$35.00)	Gravity section downstream of the north embankment

(Continued)



Table 1 (Concluded)									
RCC Completed	Name of Dam	Height, m (ft)	Length, m (ft)	RCC Volume, m <sup>3</sup> (yd <sup>3</sup> )	Cement + Fly Ash, kg/m <sup>3</sup> (lb/yd <sup>3</sup> )	Unit Cost, \$/m <sup>3</sup> (\$/yd <sup>3</sup> )	Application		
1990	Ringtown No. 5	18.3 (60)	213 (700)	4,815 (6,300)	135 + 103 (228 + 174)	\$60.16 (\$46.00)	Combined principal & emergency spillway		
1990	Santa Cruz	45.7 (150)	152.4 (500)	29,435 (38,500)	76 + 75 (128 + 127)	\$59.83 (\$45.74)	Downstream buttress for seismic strengthening		
1990	Thompson Park No. 3	9.1 (30)		2,085 (2,730)	196 + 0 (330 + 0)		Embankment overtopping protection		
1991	Ashton	18.3 (60)	68.9 (226)	5,885 (7,700)	178 + 59 (300 + 100)		Embankment overtopping protection		
1991	Lake Lenape	5.2 (17)	320 (1,050)	2,332 (3,050)	173 + 0 (292 + 0)	\$91.56 (\$70.00)	Embankment overtopping protection		
1991	Saltlick	33.5 (110)	255 (835)	8,485 (11,100)	69 + 74 (117 + 125)		Two emergency spillways		
1991	White Meadow Lake	4.6 (15)	91.4 (300)	765 (1,000)	173 + 0 (292 + 0)		Embankment overtopping protection		
1992	Butler Reservoir and Soil Erosion	13.1 (43)		8,870 (11,000)	132 + 96 (223 + 162)		Embankment overtopping protection, spillways, & stilling basin		
1992	Camp Dyer Diversion	22.9 (75)	182.9 (600)	11,775 (15,400)	82 + 82 (138 + 138)	\$59.64 (\$45.60)	Downstream buttress for sliding stability		
1992	Horsethief	19.8 (65)	167.6 (550)	4,780 (6,250)	193 + 0 (325 + 0)	\$65.40 (\$50.00)	Embankment overtopping protection		
1992	Meadowlark Lake	8.5 (28)	106.7 (350)	1,950 (2,550)	193 + 0 (325 + 0)	\$86.65 (\$66.25)	Embankment overtopping protection		
1992	North Potato Creek	28.0 (92)	244 (800)	3,440 (4,500)	101 + 65 (170 + 110)	\$85.68 (\$65.51)	New spillway		
1992	Phillipsburg No. 3	5.5 (18)	73.2 (240)	1,070 (1,400)	173 + 0 (292 + 0)		Embankment overtopping and scour protection		
1993	Ponca	10.7 (35)	144.5 (474)	5,890 (7,700)	119 + 101 (200 + 170)	\$86.69 (\$66.28)	Combined service and emergency spillway		
1993	Rosebud	11.3 (37)	121.9 (400)	3,590 (4,700)	78 + 90 (131 + 151)	\$100.24 (\$76.64)	Embankment overtopping protection		
1994	Littlerock	51.8 (170)	219.5 (720)	70,490 (92,200)	65 + 98 (110 + 165)		Downstream buttress for seismic strengthening		
1995	South Prong	18.9 (62)	1,158 (3,800)	39,760 (52,000)	160 + 0 (270 + 0)	\$52.87 (\$40.42)	New emergency spillway		

been choked with concrete to produce a 1.54H:1.0V downstream slope (Figure 1).

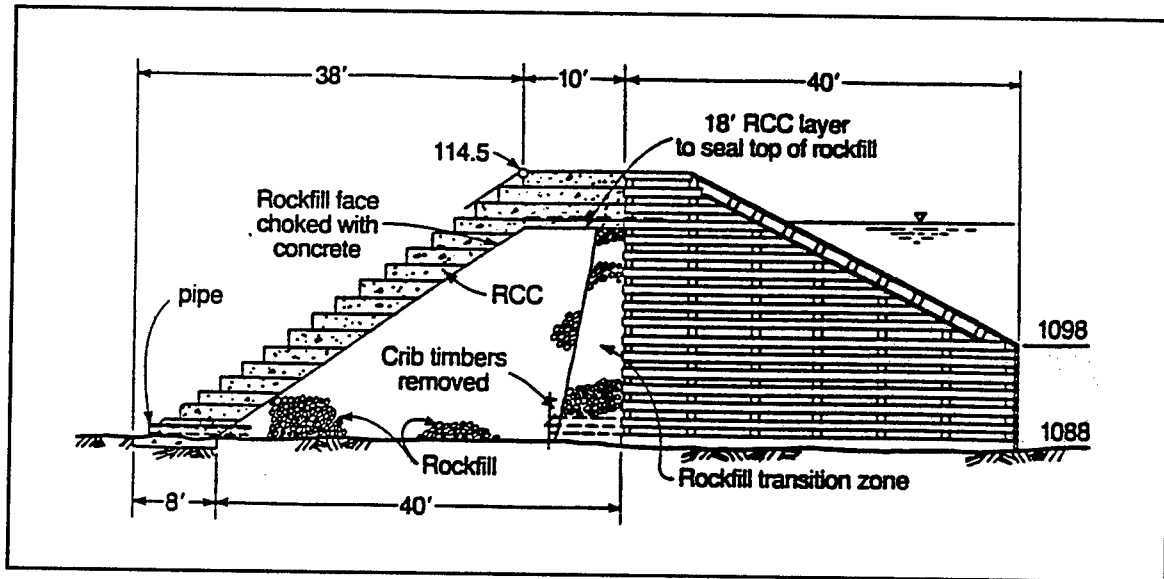

Figure 1. Cross section showing rehabilitation plan for Ocoee Dam. (Multiply feet by 0.3048 to obtain metres)

During the time power generation was suspended, the recreational potential of the area was realized. Water not diverted through the flume spilled over the dam and created a white-water recreation stream. Even after rehabilitation of the dam and flume, power generation is interrupted and the dam is intentionally overtopped approximately 80 days a year to accommodate white-water rafters (Buttrely 1983). The rafting outfitters reimburse the TVA for lost hydropower revenues when the dam is intentionally overtopped.

After more than 1,000 overtoppings of the rehabilitated structure, including a 3.7-m (12-ft-) depth of flow during a flood in early 1990, the RCC remains in good condition (Figure 2). Except for some erosion of poorly compacted RCC at the downstream toe, the RCC has not been damaged by water and weathering.

The durability of the RCC will be tested even further in 1996 when the number of planned overtoppings will double. The canoeing and kayaking events for the Olympic Games to be held in Atlanta will take place in the Ocoee River upstream of Ocoee Dam.

### Toutle River Dam

After Mt. St. Helens erupted in 1980, the U.S. Army Corps of Engineers (USACE) became concerned about keeping the downstream channel of the Toutle River free of volcanic debris. As a temporary solution, the Corps built an 11.6-m- (38-ft-) high retaining dam with a shotcrete-covered gabion spillway on the North Fork of the river (Hansen and France 1986). By the time the



Figure 2. Downstream face of Ocoee Dam with RCC overtopping protection

structure was 1 month old, the spillway had failed because of erosion caused by high flows and debris (Figure 3).



Figure 3. Failed gabion spillway, Toutle River

The USACE needed a quick and economical method for replacing the spillway before debris blocked the channel. Steel mesh-reinforced RCC was the option selected. The replacement spillway was 91.4 m (300 ft) wide with a 36.6-m- (120-ft-) long downstream apron. It had a horizontal crest and a downstream slope of 1:4 (Hansen 1989a).

Steel sheetpiling was placed at the spillway entrance and at the end of the apron to serve as forms. Reinforcing consisted of two layers of welded fabric, one placed within 152 to 229 mm (6 to 9 in.) of the top surface and the other the same distance from the bottom. The spillway thickness was 1.30 m (4.25 ft) (Hansen and France 1986). The downstream apron was placed first, followed by the slope and then the crest (Figure 4). The project required approximately 13,762 cu m (18,000 cu yd) of RCC, which was placed in 60 hr over 6 days (Hansen 1989a). The RCC, which was batched near the site, had a compressive strength of 37.9 MPa (5,500 psi) at 45 days.

For 6 months, the replacement structure held against overflows with estimated velocities of 4.6 to 6.1 mps (15 to 20 fps). For the next 5 months, ash-laden water and rocks up to 0.6 m (2 ft) in diam passed over the spillway as a result of the reservoir's being filled with sediment debris. Mt. St. Helens erupted again in March 1982, sending even more abrasive material down the river. This material eroded a 152-mm- (6-in.-) deep groove at the cold joint in the center of the spillway where compaction was poor and exposed the steel mesh in at least one spot. In other areas, the RCC was eroded to the point that it resembled a terrazzo finish (Hansen 1989a).

Although the RCC spillway performed well, the earth embankment failed because of overtopping after the reservoir had filled with debris. Instead of repairing the breached dam, the USACE decided to build a permanent sediment retaining structure 56.4 m (185 ft) high downstream of the dam (Hansen 1989a).

### **Brownwood Country Club Dam**

Brownwood Country Club Dam is a 5.8-m- (19-ft-) high earthfill dam that forms a reservoir in the middle of the golf course at the country club in Brownwood, TX. It has an impoundment of 215,860 cu m (175 acre-ft) (Reeves 1985). Originally built around 1938, the dam was constructed with a 19.8-m- (65-ft-) wide reinforced concrete slab spillway with a capacity of approximately 74 cms (2,600 cfs). A study conducted in the early 1980s determined that in the event of a probable maximum flood (PMF), the spillway would need a capacity of 328 cms (11,600 cfs) (Hansen 1993).

The state dam safety department placed the dam in the high-hazard category because of the inadequacy of the spillway and the increased development downstream of the dam (*RCC Newsletter* 1986). The country club was instructed to draw down the level of the reservoir; however, lowering the water level detracted from the appearance of the golf course. Country club officials chose to widen the spillway so it could pass the PMF (Hansen 1993).



Figure 4. RCC compaction on the downstream slope, Toutle River Dam

Options considered for increasing the spillway included excavating the right abutment, constructing a reinforced concrete spillway next to the existing spillway, or constructing the spillway with RCC. An RCC spillway was chosen (Figure 5) because it would have the lowest total cost and would require the least construction time (Morsman, Lawler, and Seimears 1985). This was the initial application of RCC to rehabilitate an existing embankment dam.

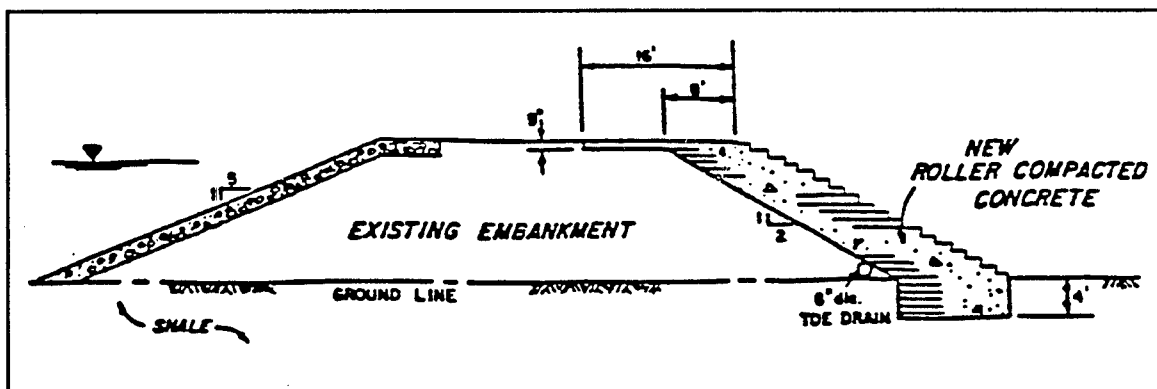

Figure 5. Cross section of modified spillway, Brownwood Country Club Dam (courtesy of Reeves 1985, ASCE). (Multiply inches by 25.4 to obtain millimetres and feet by 0.3048 to obtain metres)

Preliminary work included excavating 1.2 m (4 ft) from the crest of the dam adjacent to the existing spillway to extend the width of the spillway an additional 91.4 m (300 ft). The downstream slope was graded to 2H:1V and compacted.

Aggregate for the RCC mixture was obtained locally, and a continuous feed pugmill was set up at the site (Hansen 1993). The RCC mixture contained 6.3 percent Type 1 portland cement and 1.6 percent Class C fly ash by weight. The maximum dry density, based on American Society for Testing and Materials (ASTM) D 1557-78 (ASTM 1994b), was 2,322 kg/cu m (145 lb/cu ft), and the optimum moisture content was 5 percent (Morsman, Lawler, and Seimears 1985).

Cylinders cast with the RCC mixture and tested in the laboratory indicated the RCC would obtain a strength between 12.8 and 14.8 MPa (1,850 and 2,150 psi) in 7 days if the RCC was compacted near the maximum dry density with the equivalent Modified Proctor compactive effort (Reeves and Yates 1985).

A batch plant was set up at the site to mix the RCC (Figure 6). Dump trucks were used to transport the mixture to the fill area. RCC was first placed in a 1.2-m- (4-ft-) deep trench excavated into the shale foundation at the toe of the dam to prevent undercutting during overtopping. A modified spreader mounted on a track-type tractor was used to spread the RCC in 254-mm (10-in.) lifts. In hard-to-reach areas, a small track-type tractor was used. All RCC surfaces on which subsequent lifts would be placed were kept continuously damp until the next lift was placed. Succeeding lifts were placed within an 8-hr time limit to eliminate cold joints. A self-propelled vibratory roller was used to compact all of the RCC. The final RCC surface was kept moist for 14 days while the RCC cured (Morsman, Lawler, and Seimears 1985).

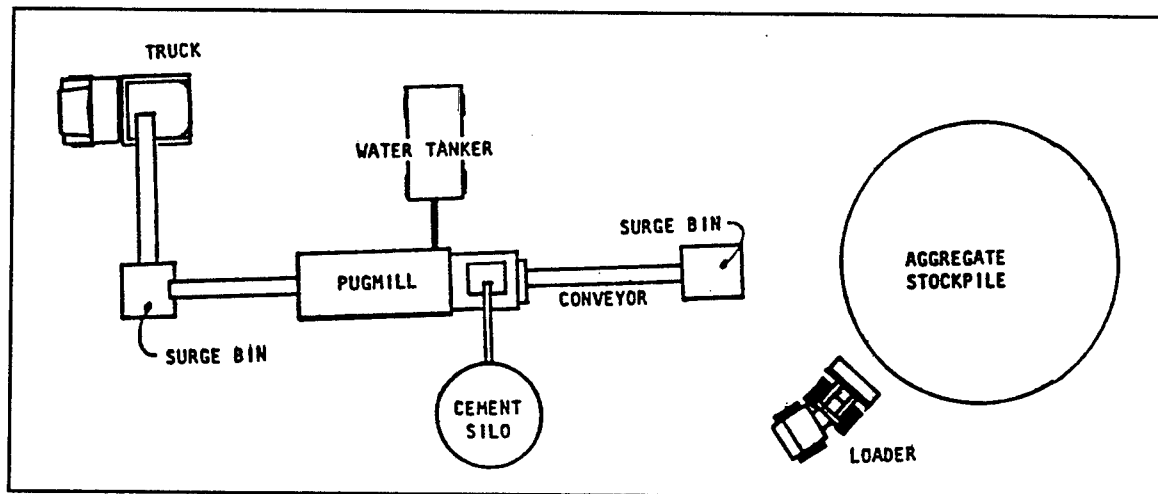

Figure 6. Layout of RCC batch plant at Brownwood Country Club Dam (courtesy of Morsman, Lawler, and Seimears 1985, ASCE)

The entire project took 2 weeks to complete; 1,070 cu m (1,400 cu yd) of RCC was placed in 2 days (Figure 7). The total cost of the spillway modification was about \$72,000, a savings of approximately \$150,000 over the estimated cost for the alternative solutions investigated (*RCC Newsletter* 1986).



Figure 7. Completed RCC spillway, Brownwood Country Club Dam

The expanded spillway has successfully withstood overtopping on at least six occasions. The maximum depth of overtopping to date has been about 0.3 m (1 ft) compared to the maximum design depth of flow of 1.7 m (5.5 ft) during the PMF event.

### **Kerrville Ponding Dam**

The Kerrville Ponding Dam, built in the channel of the Guadalupe River at Kerrville, TX, was completed in 1980 at a cost of \$1.2 million. The dam, a compacted clay embankment with a reinforced concrete facing, is 6.4 m (21 ft) high, approximately 182.9 m (600 ft) long and has a 1.5-m- (5-ft-) wide crest. A concrete cutoff wall was keyed into both abutments. Both faces of the dam slope 3:1. A 70-m- (200-ft-) long section of the dam near the left abutment was lowered 0.3 m (1 ft) to serve as a service spillway. The emergency spillway was 6.7 m (22 ft) high. The entire embankment was designed to be overtopped during flood conditions (Smith 1986).

The dam was overtopped by 1.2 m (4 ft) in June 1981, when it sustained some damage. It was overtopped again in October 1982 by 1.4 m (4.5 ft); this time damage was more severe. Then on New Year's Eve 1984, the dam was overtopped by 3.0 m (10 ft). Damage included a loss of about 40 percent of the concrete shell over the service spillway and about one-half of the downstream embankment, severe concrete cracking in the emergency spillway, loss of filter material, and erosion in both abutments (Figure 8). The clay core was eroded to bedrock (Smith 1986).

Several alternatives, including repair of the existing structure, were evaluated, but design engineers and consultants determined the fastest and most economical solution was to construct a new RCC section on the downstream embankment (Figure 9).

An RCC mixture was proportioned with 89-mm- (3.5-in.-) maximum size pit-run aggregate and 10 percent cement by weight. This mixture was used at the base and crest of the dam. The cement content was reduced to 5 percent for the middle of the gravity section. The compressive strength of the richer mixture exceeded 13.8 MPa (2,000 psi) at 28 days.

In preparation for the RCC, the downstream portion of the embankment was removed; the undamaged upstream portion served as a cofferdam during construction of the RCC section (Figure 10). The RCC was placed in 0.3-m- (1-ft-) thick lifts, beginning on the foundation rock against the near-vertical face of the embankment. A sand-cement mortar was brushed on each lift as a bonding agent. RCC placement began in June 1985 and was completed 3 months later. Approximately 16,820 cu m (22,000 cu yd) of RCC was used in the project (Hansen and France 1986). Cost of the repairs, including engineering, construction, and stabilizing the remaining portions of the original dam, was between \$3 and \$3.5 million (Smith 1986).

In October 1985, about a month following completion of RCC placement, a 279-mm (11-in.) rain caused a once-in-50-years flood. The new RCC gravity section was overtopped by 4.4 m (14.4 ft), and the emergency spillway by 4.1 m (13.4 ft). At its crest, the flood reached a flow of 3,540 cms (125,000 cfs) over the dam (*RCC Newsletter* 1986). Water flowed over the entire dam for about 5 days and over the service spillway for 3 weeks. An inspection of the dam following the flood revealed significant erosion in the uncompleted earthen abutments; however, damage to the RCC was limited to some minor surface spalling (Figure 11).

In 1987, the area was hit with a once-in-100-years flood. Overtopping reached 4.9 m (16.2 ft) with a maximum flow of 4,590 cms (162,000 cfs). Once again, the only damage to the RCC was minor spalling (*RCC Newsletter* 1988).

### **Spring Creek Dam**

Spring Creek Dam is a 15.2-m- (50-ft-) high, 173.7-m- (570-ft-) long earth-fill dam located north of Gunnison in the Colorado mountains. The dam was constructed in 1960 and 61. In 1979, the U.S. Army Corps of Engineers inspected high-hazard dams in Colorado, including Spring Creek Dam. The inspection determined the spillway capacity at Spring Creek Dam was insufficient to pass the PMF.

A decision was made to modify the dam by providing protection to the crest and the downstream slope so the dam could overtop during flood conditions without the embankment's suffering erosion damage. Several alternatives for the



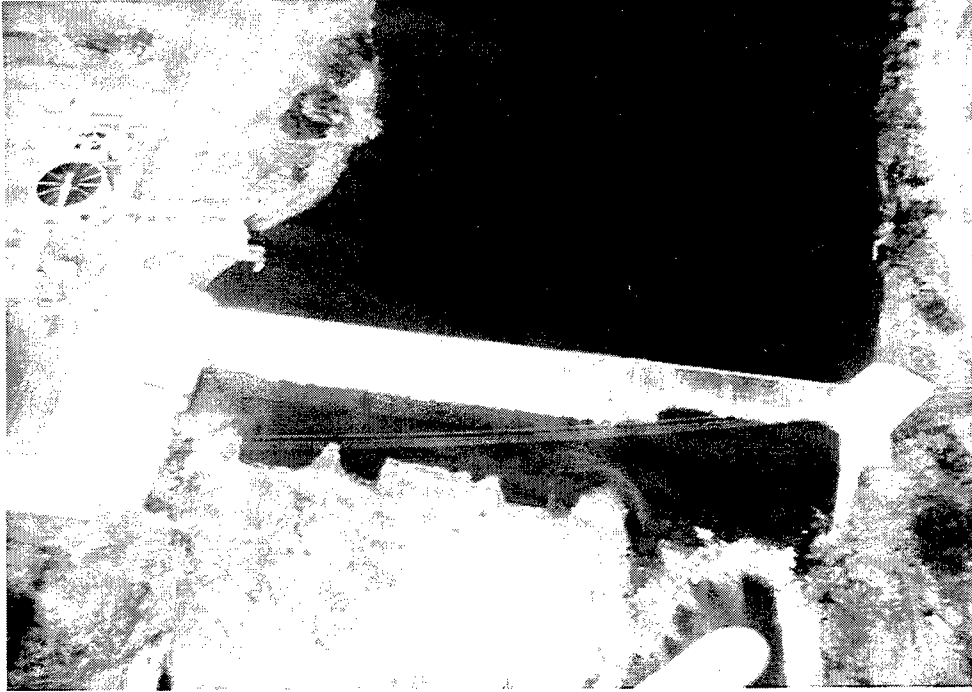

a. Overall view of dam



b. Closeup view of spillway damage

Figure 8. Overtopping damage to service spillway, Kerrville Ponding Dam

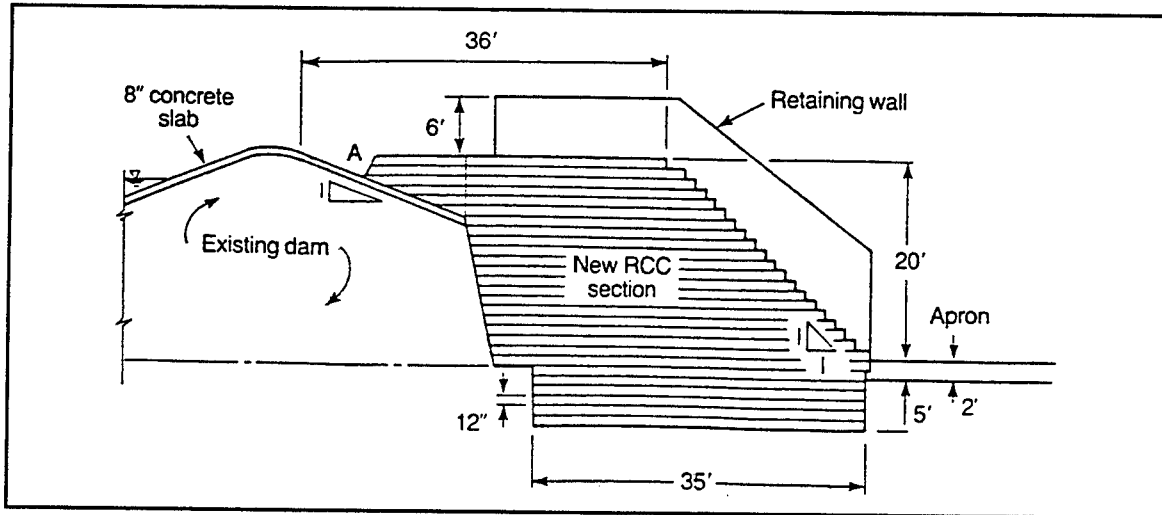

Figure 9. Plan for RCC gravity buttress, Kerrville Pounding Dam (courtesy of Hansen and France 1986). (Multiply inches by 25.4 to obtain millimetres and feet by 0.3048 to obtain metres)

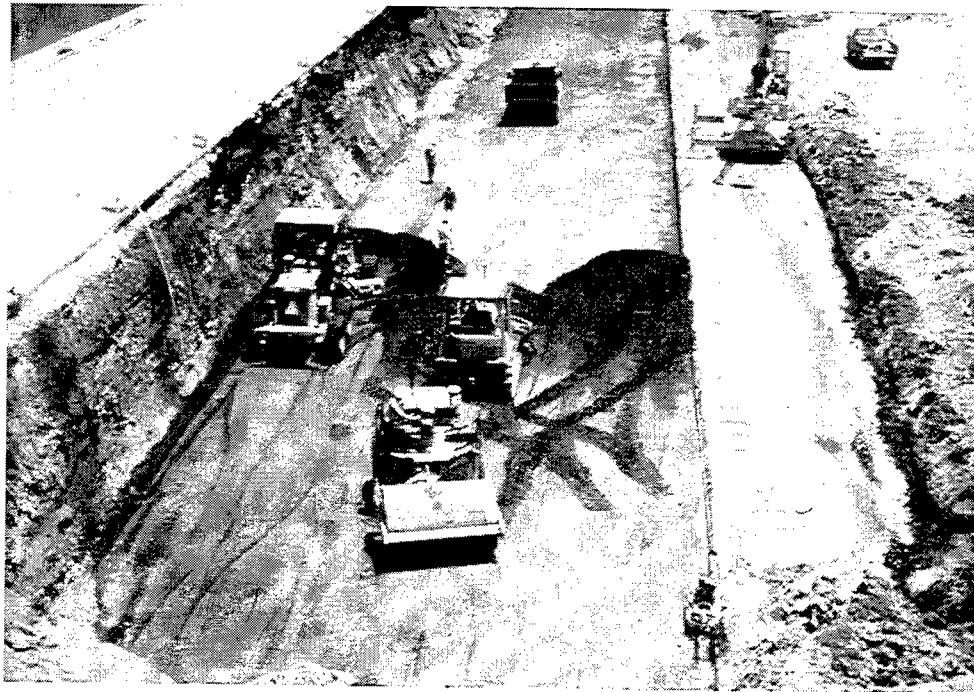

Figure 10. RCC placing and compaction, Kerrville Pounding Dam



Figure 11. Condition of the RCC following overtopping, Kerrville Ponding Dam

planned modification were studied. Factors that had to be considered were the project site (a high mountain region with limited access), the short construction period, the availability of material, and cost-effectiveness. RCC was selected as the material that best met these requirements (*RCC Newsletter 1987*).

Design details for RCC dam embankment protection require careful attention at the crest, downstream slope, and the downstream toe. Model studies have shown that a 0.6-m- (2-ft-) thick layer of RCC that extends to the dam's center line will provide adequate protection for the crest for overtopping depths of 0.9 or 1.2 m (3 or 4 ft). If greater depths are expected, the RCC should be extended entirely across the center of the crest (Hansen and France 1986). To form the overflow section in the crest of Spring Creek Dam, the contractor removed a section of the embankment 76.2 m (250 ft) wide and 0.9 m (3 ft) deep and placed RCC across its full width. The earth that was removed was used to raise the height of the remainder of the dam by 2.4 m (8 ft) (*RCC Newsletter 1987*).

Because the toe area of the downstream slope is subject to high velocities and turbulence during overtopping, it must be provided erosion protection to prevent undermining of the RCC. One solution is to construct an RCC apron that extends out from the toe. A concrete cutoff wall constructed at the end of the apron and extending deep enough to prevent undermining of the apron provides additional protection (Hansen and France 1986). At Spring Creek, a 0.9-m- (3-ft-) thick by 15.2-m- (50-ft-) long RCC apron was constructed at the downstream toe. To prevent undermining, a 1.5-m- (5-ft-) deep by 1.8-m- (6-ft-) wide RCC key was used to anchor the downstream end of the apron (*RCC Newsletter 1987*).

RCC was placed to a depth of 0.9 m (3 ft) in the overflow section on the downstream face of the dam. It was placed in 2.4-m- (8-ft-) wide by 0.3-m- (1-ft-) thick horizontal layers to form a stairstep profile, which would help dissipate energy during overtopping (Figure 12). The horizontal layers were turned at the abutment to create a groin that would contain the design flood (Figure 13). The crest slab was anchored on the upstream side by a 1.5-m- (5-ft-) deep by 1.8-m- (6-ft-) wide RCC cutoff key.

Studies indicate a drainage system should be constructed under RCC slope protection to control seepage and prevent hydrostatic pressure buildup (Hansen and France 1986). To provide underdrainage at Spring Creek Dam, the contractor placed a 0.3-m- (1-ft-) thick layer of processed, free-draining material under the lower half of the RCC on the downstream face and a portion of the apron. Perforated PVC pipes were embedded in this material and up the groin and service chute spillway. These pipes discharged at measuring points downstream of the apron. To relieve uplift pressures, 76-mm- (3-in.-) diam weep drains were placed through the RCC at several elevations (*RCC Newsletter* 1987).

Locally available aggregate was used in the RCC mixture, which was proportioned to be erosion resistant and to withstand cycles of freezing and thawing. The mixture contained 379 kg/cu m (225 lb/cu yd) of cement (*RCC Newsletter* 1987).

The contractor placed 3,823 cu m (5,000 cu yd) of RCC in four 24-hr shifts. Unit cost for the RCC, including production, materials, and placement was \$49.05/cu m (\$37.50/cu yd). Total cost of the project was \$279,414, approximately \$380,000 (63 percent) less than that estimated for other alternatives.

### **Addicks and Barker Dams**

The U.S. Army Engineer District, Galveston, owns and operates Barker and Addicks Dams, which are located just west of Houston, TX. Both projects are used for flood control but do not impound water. The dams are rolled earthen embankments with a 4.6-m- (15-ft-) wide graveled crest. Barker Dam is approximately 21,950 m (72,000 ft) long; Addicks, approximately 18,590 (61,000 ft).

In 1987, the District began rehabilitation of the 40-year-old structures as part of its Dam Safety Assurance Program. Studies based on engineering standards at that time indicated that both dams would be overtopped in the event of a PMF (*RCC Newsletter* 1988). Plans for rehabilitating the dams included raising the central part of the dams by approximately 1.5 m (5 ft) and armorplating the lower ends of each dam to create overflow spillways. A number of options were studied, including conventional concrete paving and soil cement. The Corps chose RCC for the armorplating because of its high strength and abrasion resistance; also, it was about 50 percent cheaper than conventional concrete (Lawson 1988).

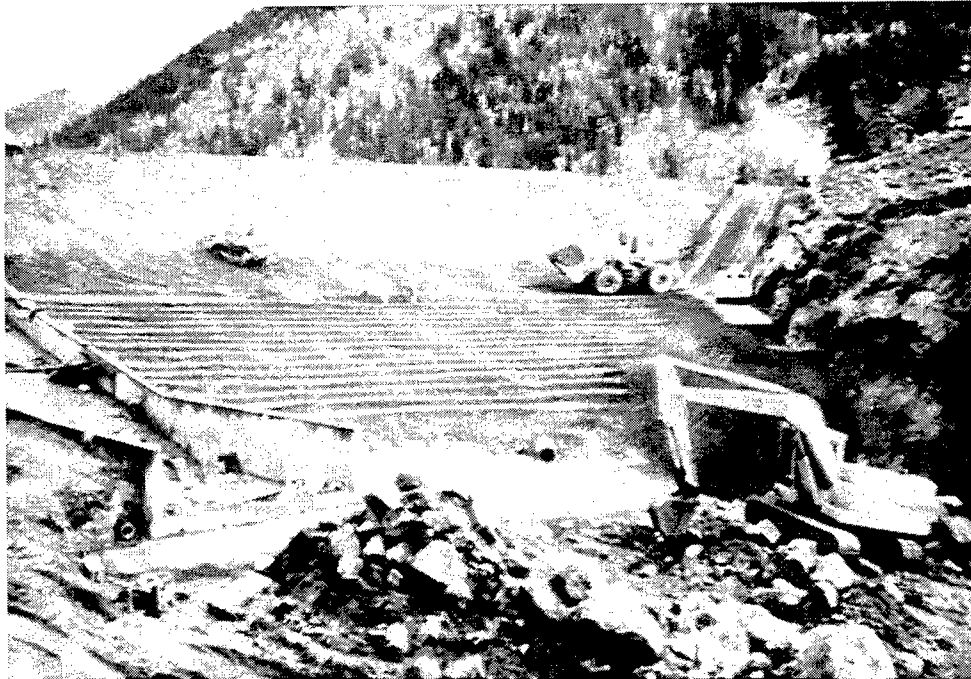

Figure 12. RCC placement, Spring Creek Dam

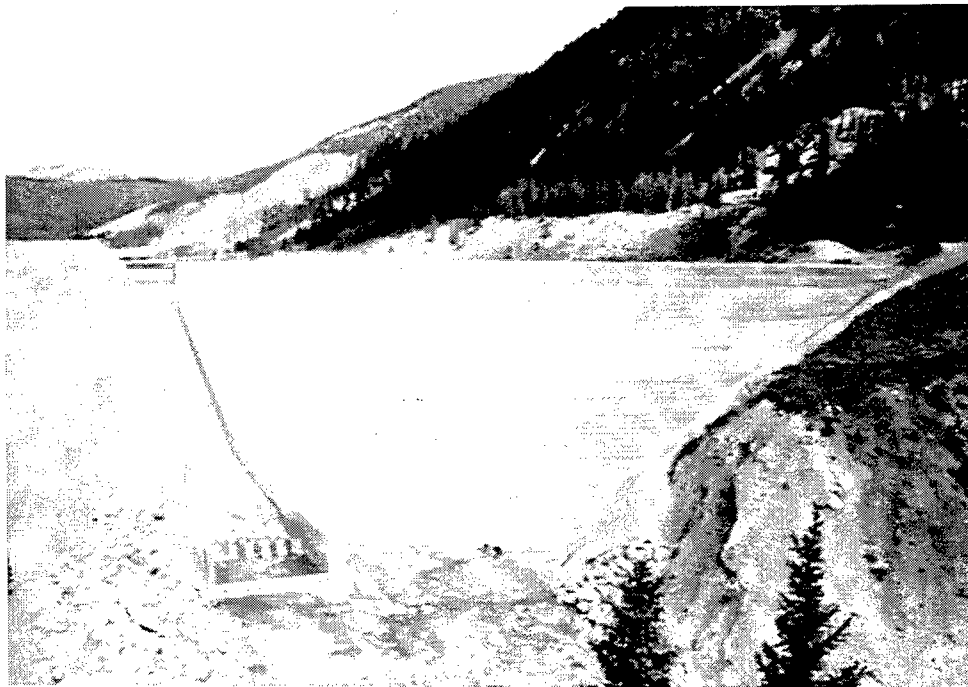

Figure 13. Completed emergency spillway, Spring Creek Dam

A \$2.3-million contract for the RCC work was awarded to Ernst Paving Company, Inc., Dayton, OH. Ernst was a subcontractor to Hassell Construction Company, Houston, the holder of a \$5.3-million prime contract for safety improvements to the two dams (Munn 1988).

The mixture proportions for the RCC used on this project were as follows:

Material	Weight, kg/cu m (lb/cu yd)
Cement (Type I, low alkali)	173.2 (292)
Fly ash (Class C)	144.8 (244)
Fine aggregate	798.6 (1,346)
Coarse aggregate	1,282.1 (2,161)
Water	87.8 (148)

Maximum density was 2,454 kg/cu m (153.2 pcf), and optimum moisture content was 4.9 percent (Lawson 1988). Laboratory flexural strengths averaged a minimum of 7.6 MPa (1,100 psi) at 14 days (RCC Newsletter 1988).

Before placing the RCC, the contractor used a 9,070-kg (20,000-lb) bulldozer to compact the area to be plated. The RCC was produced at the rate of 191 cu m (250 cu yd) per hr in a twin-shaft pug mill. During paving of flat surfaces, the mixture was delivered by trucks in 6.1-cu-m (8-cu-yd) loads. The plating was accomplished with two asphalt laydown machines equipped with twin tamping bars and two roller machines with double-drum vibratory. The RCC was placed in four to seven passes along the longitudinal axis of the dam.

A unique aspect of this project was that of the approximately 209,000 sq m (250,000 sq yd) of 203-mm- (8-in.) thick RCC placed, nearly 125,400 sq m (150,000 sq yd) were placed on the upstream and downstream slopes of the dams (Figure 14). It is believed this was the first time in the United States that RCC had been placed on a slope (Munn 1988). The contractor had to overcome two major problems when he began placing RCC on the slopes. First, the delivery system used for flat surfaces was not satisfactory during placement of the RCC on the slopes. Delivery was restricted from below because placement of the RCC was begun at the bottom of the slope, and the haul trucks rutted the substrate when delivering from above. As an alternative, the contractor used a pair of tracked loaders to transfer the mixture to the pavers, but they too damaged the substrate. Later, the contractor fitted two dozers with a 9-m (30-ft) conveyor which enabled them to deliver the mixture almost continuously from the trucks to the pavers. With this method of delivery, plating increased from 61 to almost 152 m (200 to almost 500 ft) per day (Munn 1988).

An additional problem was finding a way to place RCC on the downstream slope of the dams without having the 25,400-kg (56,000-lb) paver slide down the slope. The contractor installed a 18,140-kg (20-ton) winch on the end of the dozer and used it to control a 22.2-mm (7/8-in.) cable attached to the paving

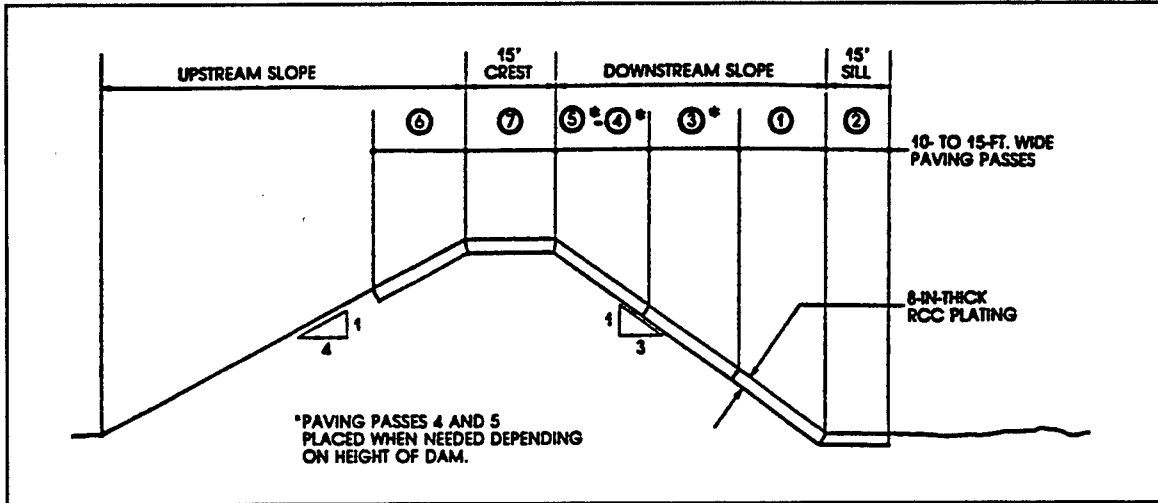

Figure 14. Paving sequence for placing RCC at Addicks and Barker Dams (courtesy of Munn 1988). (Multiply inches by 25.4 to obtain millimetres and feet by 0.3048 to obtain metres)

machine; the two machines moved together, the bulldozer riding the crest to provide a counterweight to the paver (Figure 15)



Figure 15. RCC paver connected to a bulldozer for paving slopes at Barker Dam

The paving sequence and the need for roller compaction behind the pavers were determined by the job specifications. Paving seams that were exposed for more than 1 hr were treated as cold joints. Because placement of the RCC on the slopes required more time, the paving sequence began with the lowest sloped downstream plating. The downstream apron was placed next by the second paver, which worked about 1/2 hr behind the first. If more than one sloping downstream pass was necessary, the two laydown machines alternated passes until they reached the crest. The upstream face was always the next-to-last pass and was placed by the first paver if only one downstream pass was required. The crest was placed last (Figure 14).

Setting of the RCC seams between the sloping passes and the crest slab was delayed by placing wet burlap over the upper edges of the two sloping passes. At midday, a backhoe was used to remove the irregular ends of each pass if another placement was to be made in the afternoon. The last pass each day set overnight. The ends were removed with a diamond saw the next morning before paving began.

The specified compaction for the crest and apron was 95 percent of modified Proctor. Achieving this density required frequent use of pneumatic and vibratory rollers on flat surfaces. However, the required compaction was easily accomplished on the slopes with twin tamping bars on the pavers. When rolling was necessary, it was done within 1 hour of placement (Munn 1988).

The Corps of Engineers specified water instead of a curing compound. About 6,430 ℓ (1,700 gal) of water per hr, 24 hr a day for 7 consecutive days was used to cure each 457-m (1,500-ft) section. The project required approximately 75,700 ℓ (20,000 gal) of water per day (Munn 1988).

Weather extremes caused delays in the project. Heavy rains beginning in October halted work until March when the subgrade was completely dry. Attempts were made to work whenever the rains stopped, but the heavy pavers kept sinking into the subgrade. Record-high temperatures also caused shut-downs. When the temperature was very high, the strength of the RCC was not satisfactory, so the Corps stopped work whenever the temperature reached 34 deg C (92 deg F) (Lawson 1988).

The project was completed in the spring of 1988. By the spring of 1990 the RCC exhibited significant distress, especially in the north end of Addicks Dam. This 2,530-m (8,300-ft-) section was placed between December 1987 and April 1988, a period of much cooler ambient temperatures than when the three other sections were placed between May and December 1988. Also, the foundation in the initial placement area was described as "wet and muddy with more silt"; in the latter placement areas, "hot and dusty." General types of distress included spalling, buckling, lane separations, and cracking. Each type of distress and possible causes are discussed in the following paragraphs.



In general, depth of spalling was a maximum at a crack or joint and decreased to a featheredge within 0.3 to 0.6 m (1 to 2 ft) perpendicular to the crack or joint (Figure 16).



Figure 16. RCC spalling along a joint, Addicks Dam

Typically, spalling of this type is caused by excessive stress concentration resulting from debris lodged in the crack or joint or an improper joint. Spalls of this type usually start as delaminations.

Buckling blowups, localized upward movements of the rigid RCC (Figure 17), ranged from rather serious 102- to 127-mm (4- to 5-in. vertical displacement) to simple shattering of the upper portion of the concrete near a transverse construction joint or crack. The most severe blowups were located in the north end of Addicks Dam. Both the larger differential between concrete placement and ambient summer temperature and the decreased potential for drying shrinkage of this section as compared to the other sections could have contributed to the increased expansion in this section.

Longitudinal separations between the crest and facing lanes (Figure 18) occurred at both dams. The wider separations, averaging about 25 mm (1 in.),



**Figure 17. Buckling blowups in RCC at Addicks Dam**

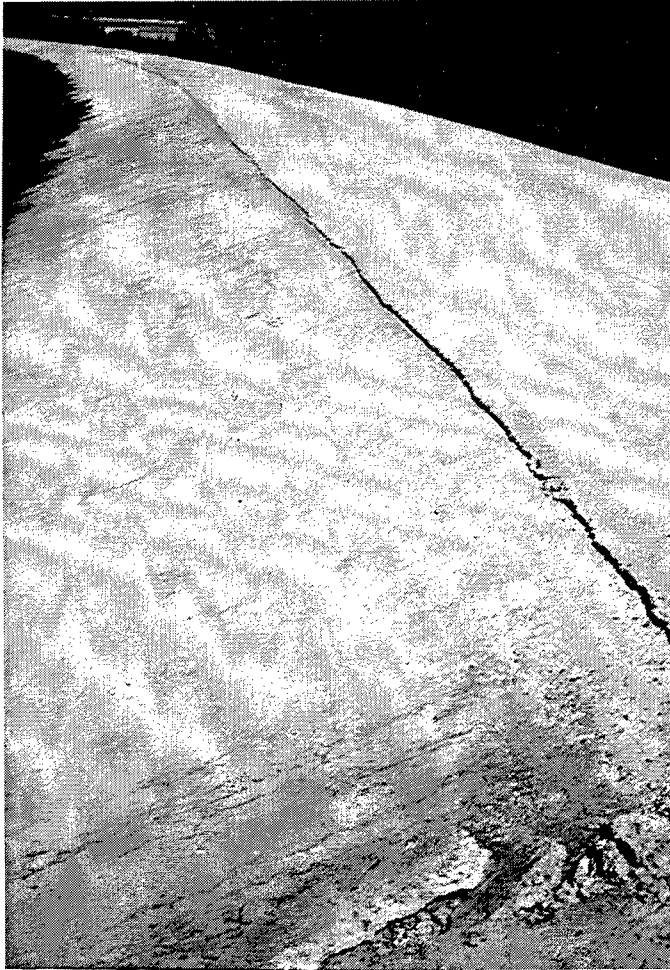

Figure 18. Typical separation of crest and slope at Addicks and Barker Dams

were located between the crest and facing lane in the first section placed at Addicks Dam. Separations between the crest and downstream facing lanes in this area appeared slightly smaller, averaging about 19.1 mm (3/4 in.). The cause of these separations could not be identified by visual inspection. Possible contributing factors were concrete drying shrinkage, foundation conditions, and movement of the inclined RCC sections.

Random cracking was noted in all RCC sections. Intermittent transverse cracking in the crest and facing lanes of all sections was attributed to concrete drying shrinkage and thermal contraction. Longitudinal cracks, some in excess of 25-mm (1-in.) widths (Figure 19), in the crest lane of the first section placed at Addicks Dam may have been caused by foundation settlement.

A contract for the repairs to the RCC was awarded in 1990. Approximately 290 sq m (350 sq yd) of concrete was used to repair areas damaged by spalling and buckling. The repair mixture was proportioned to have an average compressive strength of 20.7 MPa (3,000 psi) and a slump of no more than

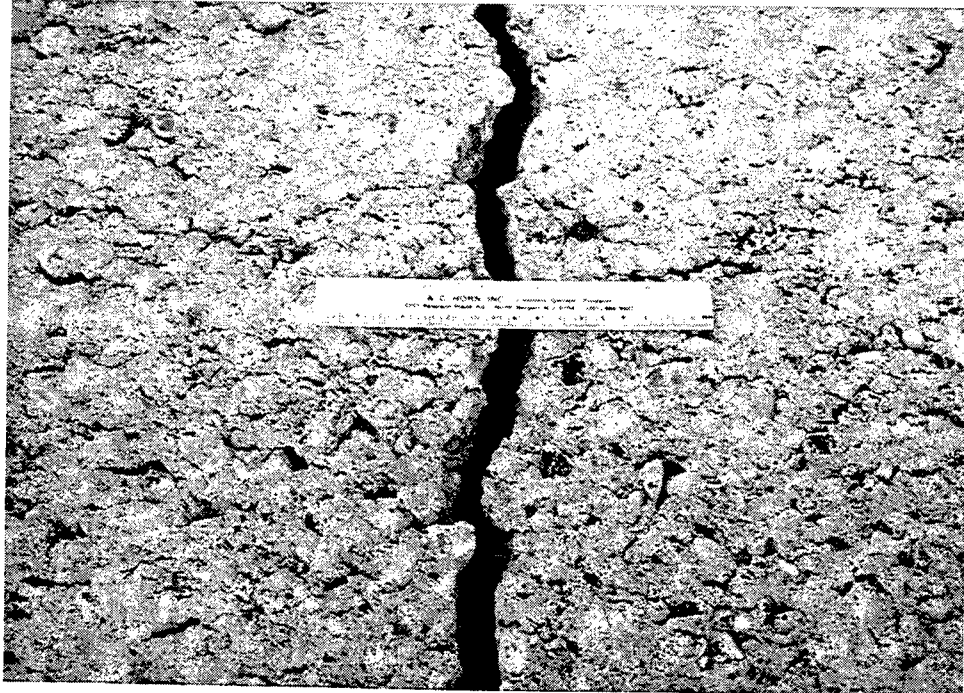

Figure 19. Longitudinal crack in the RCC armorplating at Addicks Dam

76 mm (3 in.). Each cubic yard contained a minimum of five bags of portland cement and 5 percent entrained air. Repair areas were identified by sounding cracks and construction joints to locate delamination or spalling. Spall repair involved removing and replacing damaged concrete (Figure 20). Repair



Figure 20. Removal of spalled RCC and replacement with new concrete, Barker Dam

boundaries were extended beyond the spalled areas. The sides of the repair area were vertically saw cut a depth of 51 mm (2 in.). Damaged concrete was removed down to sound, unweathered concrete, and the repair surfaces were cleaned with brooms and compressed air. Any areas that were contaminated with oil or grease were sandblasted. Epoxy-resin adhesive was used to bond the replacement concrete to the existing RCC (Figure 21).

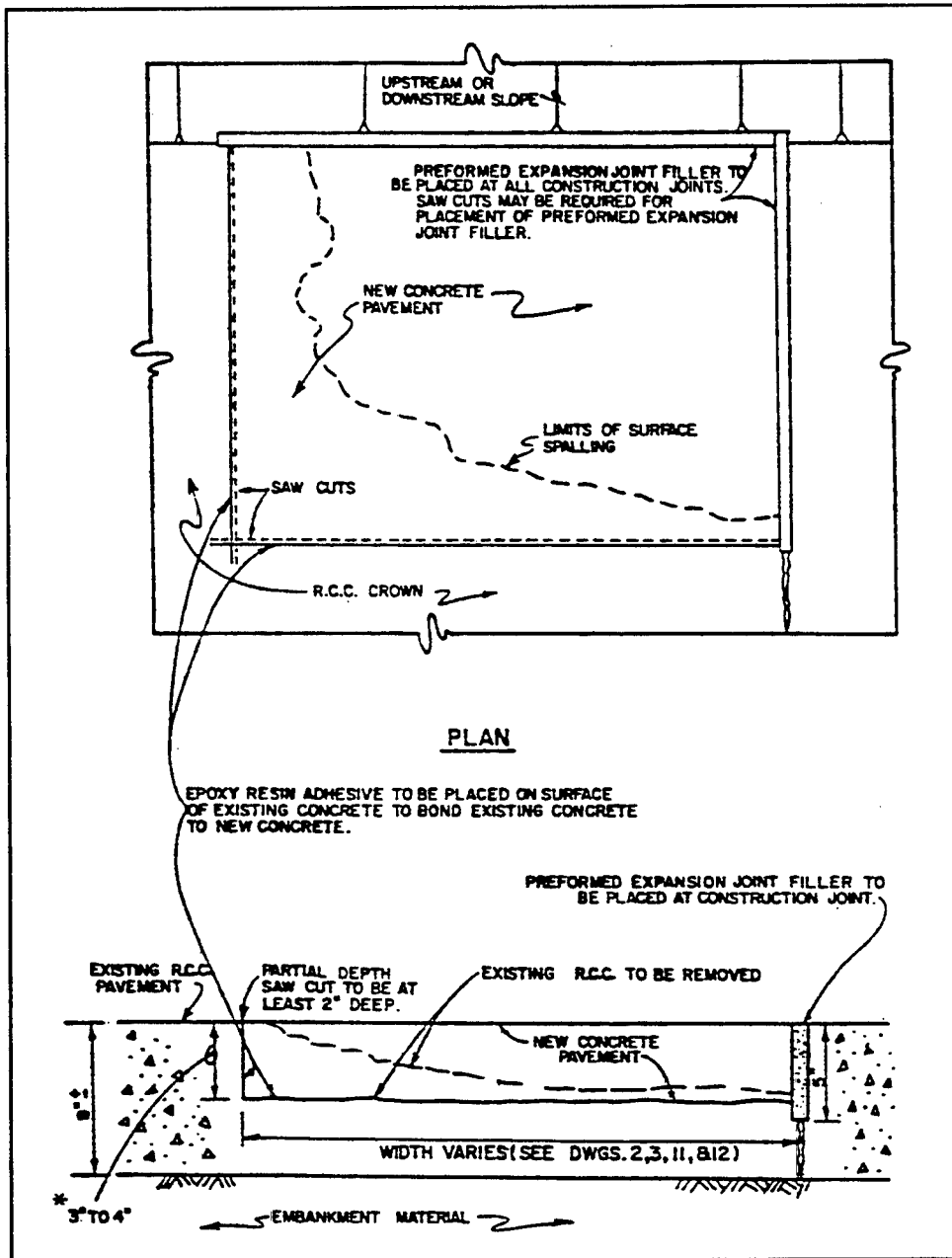

Figure 21. Typical spall repair, Addicks and Barker Dams. (Multiply inches by 25.4 to obtain millimetres)

Spalls that were 102 mm (4 in.) deep and areas that had buckled required full-depth repair (Figure 22). Full-depth saw cuts were made around the total repair area to avoid damage to surrounding concrete. The damaged concrete was removed, and the substrate was restored by excavation or filling. The area to be repaired was wetted and compacted to produce a smooth, firm, thoroughly moistened substrate. Preformed expansion joint filler was placed at full-depth saw-cut joints and lane separations.

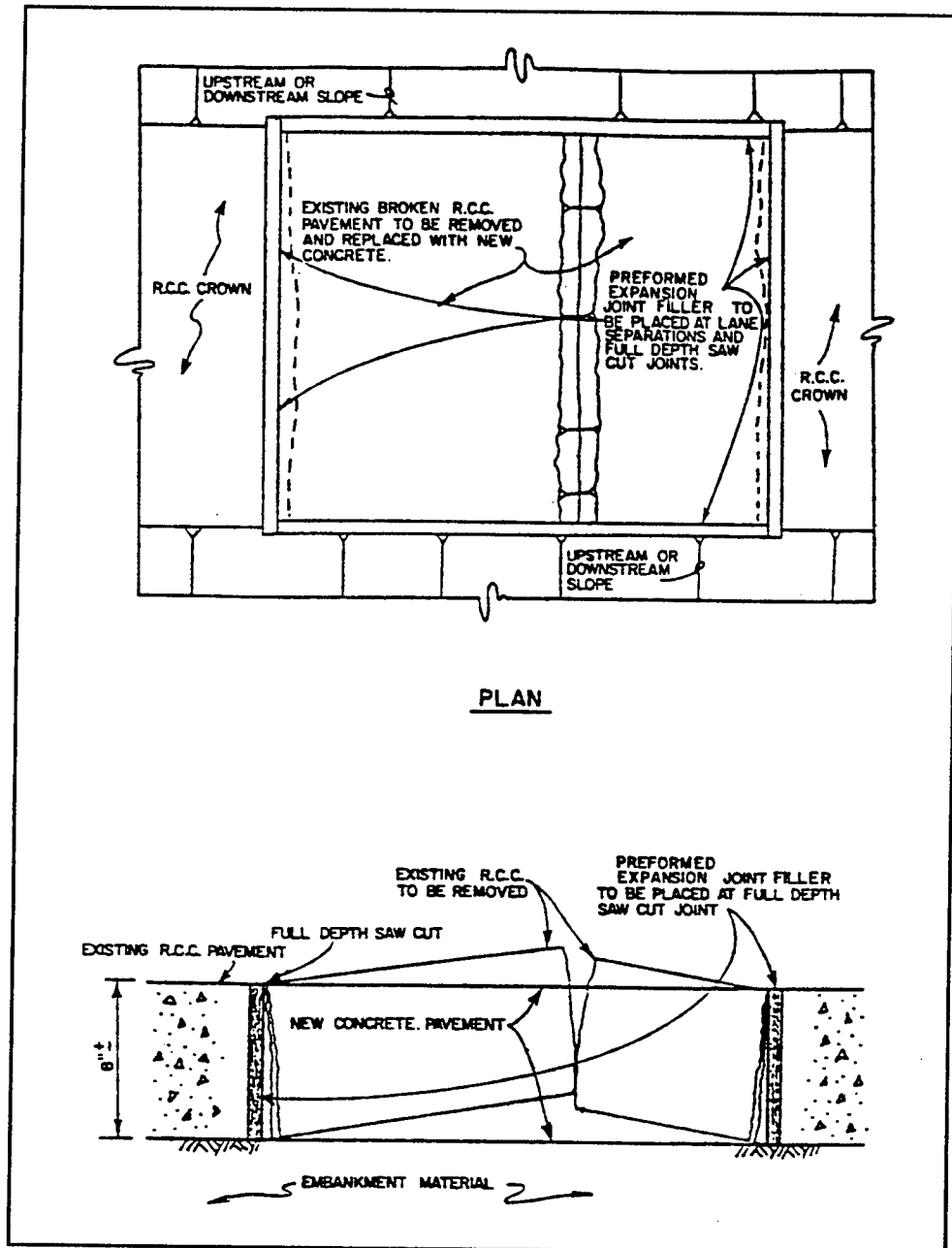

Figure 22. Typical full-depth repair of RCC at Addicks and Barker Dams. (Multiply inches by 25.4 to obtain millimetres)

All concrete was placed with a minimum of handling. Following consolidation and finishing, the concrete was cured with wet burlap.

Backer rods were installed in most lane separations (Figure 23) and larger cracks, and then the openings were sealed with crack and joint sealer (Figure 24). Backer rods were installed in approximately 640 lin m (2,100 lin ft) of these repairs. Cracks with surface widths smaller than 9.5 mm (3/8 in.) were routed to allow placement of the sealant (Figure 25).

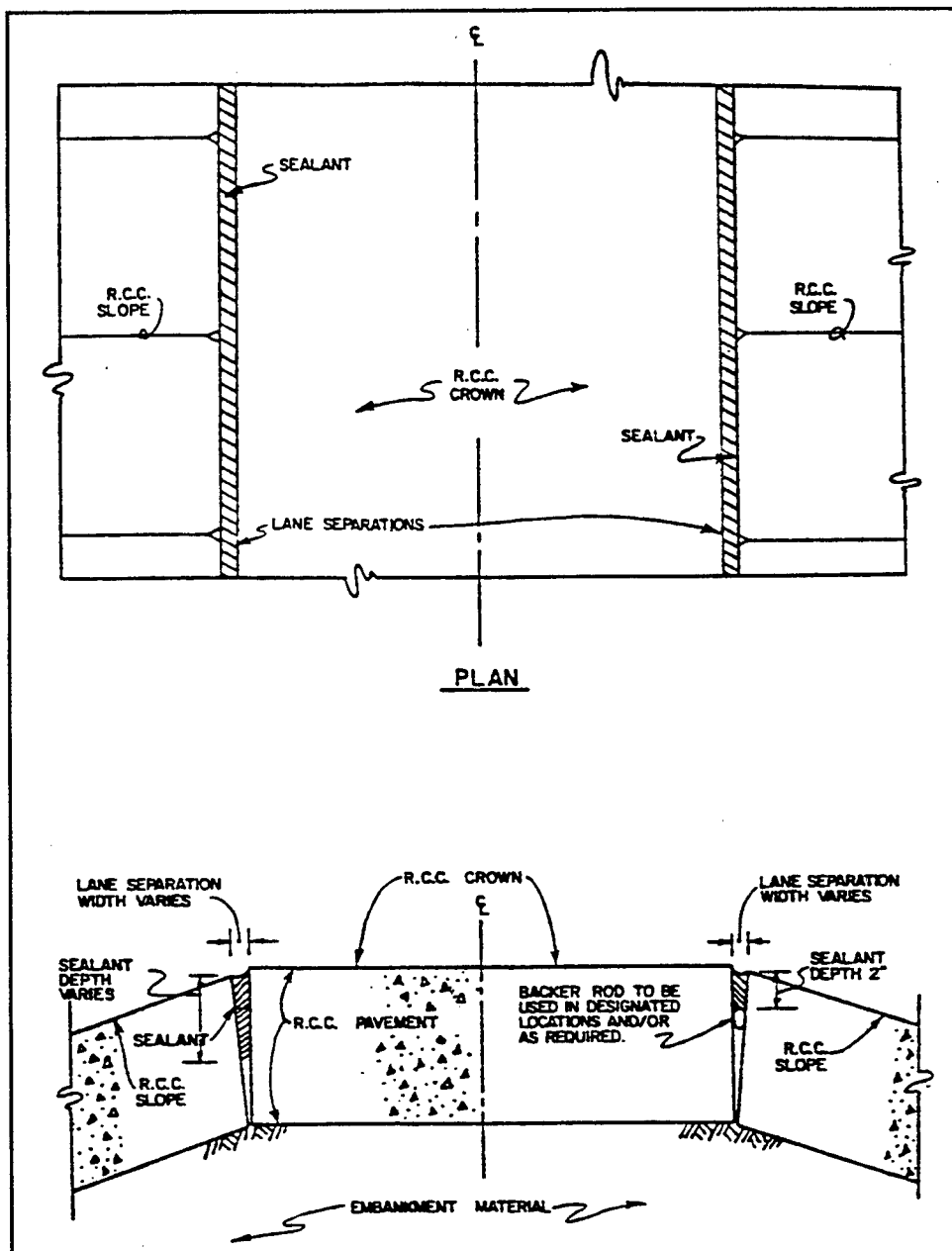

Figure 23. Typical lane separation repair at Addicks and Barker Dams.  
(Multiply inches by 25.4 to obtain millimetres)

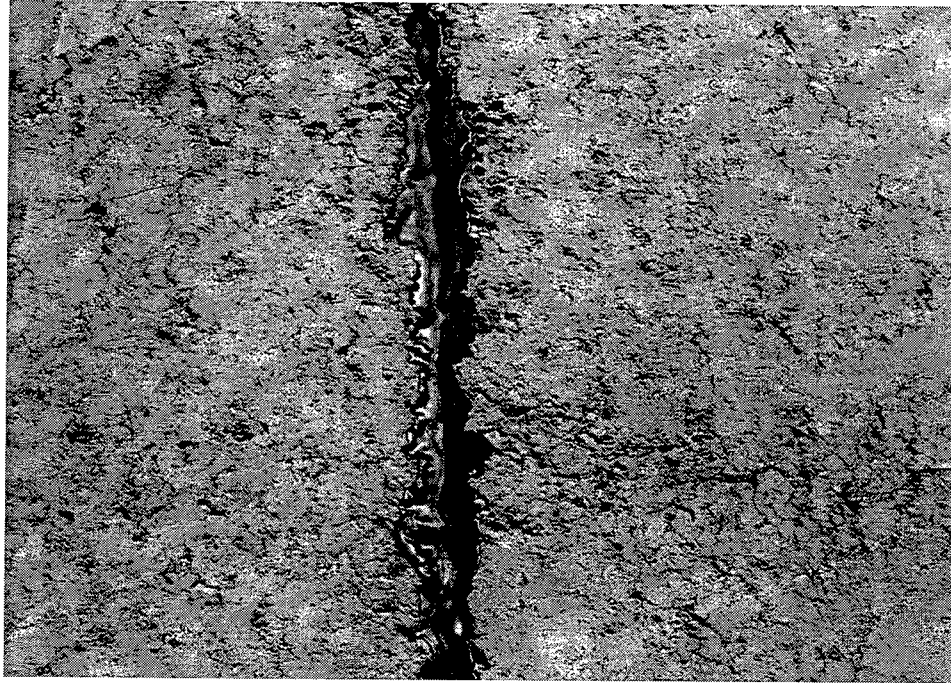

Figure 24. Joint sealant placed in RCC crack at Barker Dam

Specifications required that concrete be placed only when temperatures were between 4.5 and 32.5 deg C (40 and 90 deg F), that the temperature of the concrete at time of placement not exceed 32.5 deg C (90 deg F), and that the concrete be placed within 90 min of being charged into the mixing drum. The placed concrete was vibrated by hand spading, rodding, or tamping and had to meet the grade of the adjoining pavements and be within 3.2 mm (1/8 in.) of the true plane surface within the patched area.

Cost of the repairs, which were completed in the spring of 1991, was approximately \$145,000.

### **Comanche Trail Lake Dam**

Comanche Trail Dam is owned by the city of Big Spring, TX. The original dam on Comanche Trail Lake was built in 1914 by the Texas and Pacific Railroad to supply water for the trains. The maximum height of the unzoned embankment dam was 6.1 m (20 ft); the crest was about 198 m (650 ft) long and 2 m (7 ft) wide. The dam impounded a 435,400-cu-m- (353-acre-ft-) capacity lake. Located at the left abutment of the embankment, the spillway was about 1.5 m (5 ft) lower than the dam crest and approximately 36.6 m (120 ft) wide. The spillway channel was a grouted riprap drop structure.

Typically, the average rainfall in Big Spring is 432 mm (17 in.). However, in the summer of 1986, rain in the area exceeded the 500-year frequency and



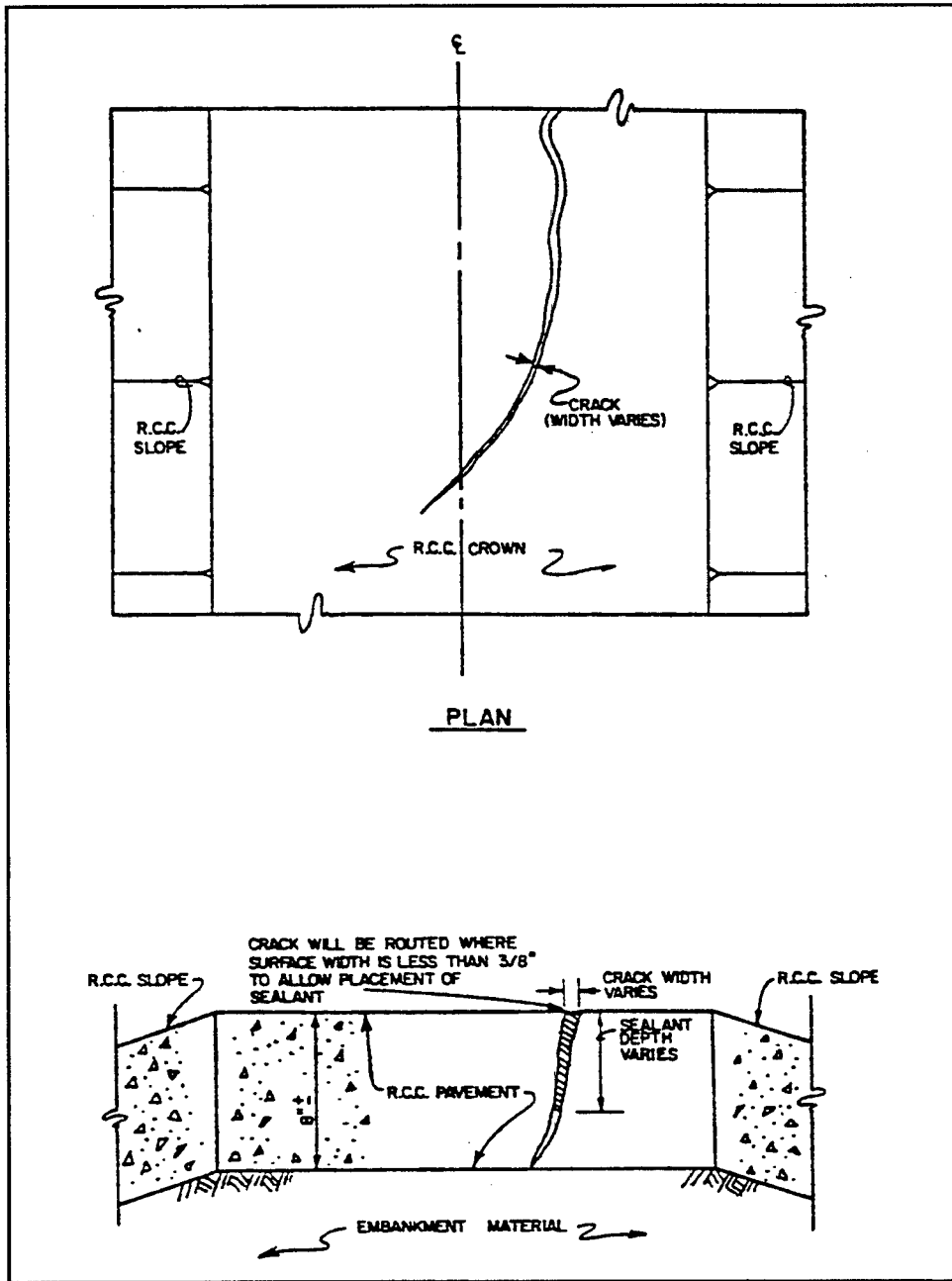

Figure 25. Typical RCC crack repair at Barker Dam. (Multiply inches by 25.4 to obtain millimetres)

resulted in significant flooding and loss of life. The Comanche Trail Lake Dam was overtopped by at least 0.6 m (2 ft), resulting in the dam's being breached and the downstream face of the embankment being severely eroded. The dam, which had been classified by the Texas Water Commission as a high hazard structure, was investigated to determine whether it could pass the PMF. The analysis indicated the 100-year flood would overtop the dam. Modifications to the dam were imperative because of downstream development. Lemons, King, and

Rutledge (1990) described the rehabilitation. This case study is a summary of their report.

The selected rehabilitation plan was one of three alternatives studied. Increasing the discharge capacity of the spillway and raising the crest of the dam were considered too cost prohibitive, and these methods would have infringed upon the wildlife habitat and nature trails built as part of a recreation area around the lake. The alternative chosen was to provide erosion protection to the embankment so that it could be safely overtopped. RCC was selected as being the most economical material for plating the embankment.

A primary consideration in the use of RCC with an embankment dam is how much the subgrade and foundation will settle. Consolidation tests indicated the maximum settlement after rehabilitation of Comanche Trail Dam would be about 25 mm (1 in.). This amount was not considered significant, so plans to place RCC on the crest, downstream embankment, and in the spillway proceeded (Figure 26).

Aggregate for the RCC mixture was obtained locally and did not require processing to meet the specified gradation. The aggregate, the cement, and the fly ash were mixed in a stationary pug mill. The mixture was transported to the site by truck, where it was placed in 305-mm (12-in.) lifts. The RCC was spread by a dozer with an attached spreader box. A mixture of one part cement to two parts dry sand was used as a bedding mixture for cold joints. The mixture was wetted immediately before the next RCC lift was placed. A self-propelled vibratory roller was used to compact each lift to 95 percent of maximum density as determined by the Reeves-Yates Method (1985). Moisture contents averaged about 0.5 percent higher than optimum. Compressive strengths were comparable to mixture proportioning test results, ranging from 9.8 to 16.3 and 13.4 to 20.2 MPa (1,415 to 2,370 and 1,950 to 2,930 psi), at 7 and 28 days, respectively.

Approximately 4,970 cu m (6,500 cu yd) of RCC was used in the project. Placement required 2 weeks. After an additional 2 weeks, two test cores were taken through the top of the RCC section. The first core had a 28-day compressive strength of 11.3 MPa (1,640 psi). The second core, which was damaged during removal from the core hole, broke at a strength of 7.9 MPa (1,150 psi); however, it did not fail through the grout plane, an indication that the bedding mixture served as an effective bonding material. The fact that the core strengths were lower than the molded strengths suggests the RCC may have lost strength because of field placement conditions or a variation in cement contents.

The 4,970 cu m (6,500 cu yd) of RCC used in the rehabilitation cost \$50.89/cu m (\$38.91/cu yd) in 1988 dollars (*RCC Newsletter* 1988).

## **Bishop Intake No. 2**

Hydroelectric power was originally developed in Nevada around the turn of the century to provide electricity to mines in the Tonopah, Silver Peak, and

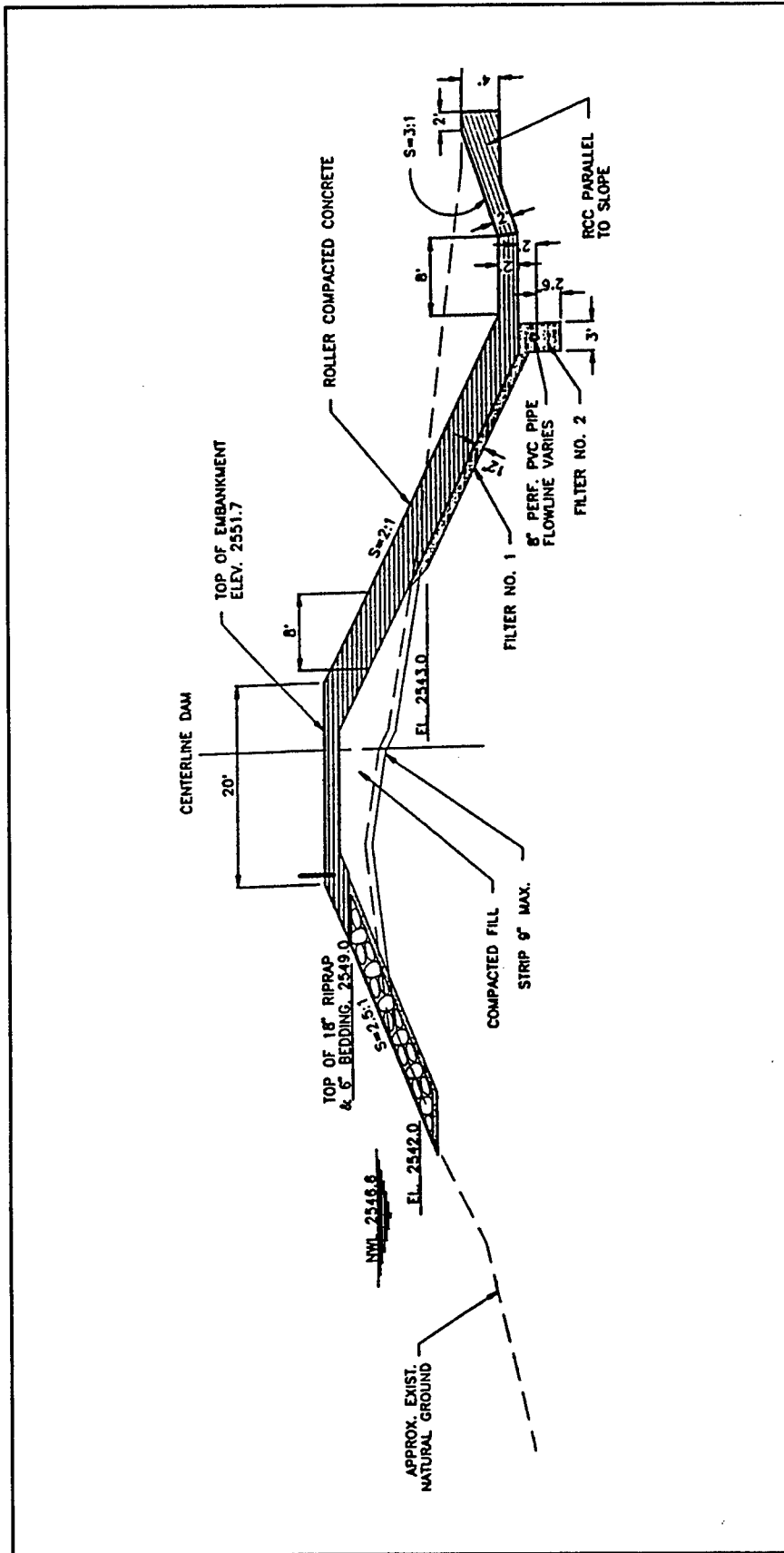

Figure 26. Plan for placing RCC on Comanche Trail Lake Dam (courtesy of Lemons, King, and Rutledge 1990, ASDSO). (Multiply inches by 25.4 to obtain millimetres and feet by 0.3048 to obtain metres)

Goldfield areas. The hydroelectric power system developed along Bishop Creek about 19 km (12 miles) southwest of Bishop, CA, was obtained by Southern California Edison (SCE) when SCE merged with Calelectric Company, formerly Nevada California Power Company, in 1963. Throckmorton and Knarr (1991) described the Bishop system and the rehabilitation done at Bishop Intake No. 2. Their report is summarized in the following.

The Bishop system has two major reservoirs and 14 hydroelectric units in five power plants, Bishop Creek 2 through 6. These major reservoirs, Sabrina Lake and South Lake, feed Bishop Creek Intake 2, the forebay for the first powerhouse. The intake is located on the Middle Fork of Bishop Creek. The dam that forms the forebay for Bishop Creek Powerhouse 2 is earth fill with a concrete core that runs over half its length. The dam is approximately 12 m (40 ft) high and 134 m (440 ft) long with a top el of 2,470.3 m (8,104.8 ft). The dam crest is 1.2 m (4 ft) wide. Both slopes are 2:1 from the left abutment to the right side of the service spillway; they slope 3:1 from the service spillway to the right abutment.

The service spillway is a 12.2-m- (40-ft-) long ogee located in the old channel. The crest elevation of the cyclopean concrete structure is at 2,468.5 m (8,098.81). Before rehabilitation the spillway could pass a flow of 34 cu m/sec (1,200 cfs) at full capacity.

The first damage to the dam occurred in 1909, about 1 year after the dam was constructed. Then in 1982, a tropical storm caused extensive damage in the Bishop area, including the failure of North Lake Dam. Even before this last damage, SCE, realizing the spillway was inadequate in the event of a PMF, had initiated studies to determine the most feasible method for increasing the spillway capacity of this dam.

As a result of several studies, SCE decided to modify the spillway to pass a flow of 170 cms (6,000 cfs). Three alternatives were considered: (a) construction of a concrete side channel spillway on the left abutment with a reinforced concrete box getaway conduit, (b) construction of a concrete side channel spillway on the right abutment with a reinforced concrete box getaway conduit, (c) construction of an RCC armored spillway over the right half of the dam with a downstream unlined getaway channel.

The RCC spillway alternative was selected because it was the most economical. The design included constructing a spillway chute on the right portion of the dam and armorplating the crest and downstream slope with RCC to provide protection from erosion in case of overtopping. The spillway chute is about 61 m (200 ft) wide and 3 m (9 ft) deep). A reinforced concrete ogee weir extends across the width of the chute. The top portion of the dam is covered with a 0.6-m- (2-ft-) thick RCC slab, and the downstream face is protected by a 0.9-m- (3-ft-) thick, stair-stepped RCC slab. The downstream slab extends to the toe of the dam where a 2.1-m- (7-ft-) deep by 5.5-m- (18-ft-) wide RCC cutoff trench has been constructed. Riprap placed downstream of this trench protects the earthen embankment from erosion (Figure 27).

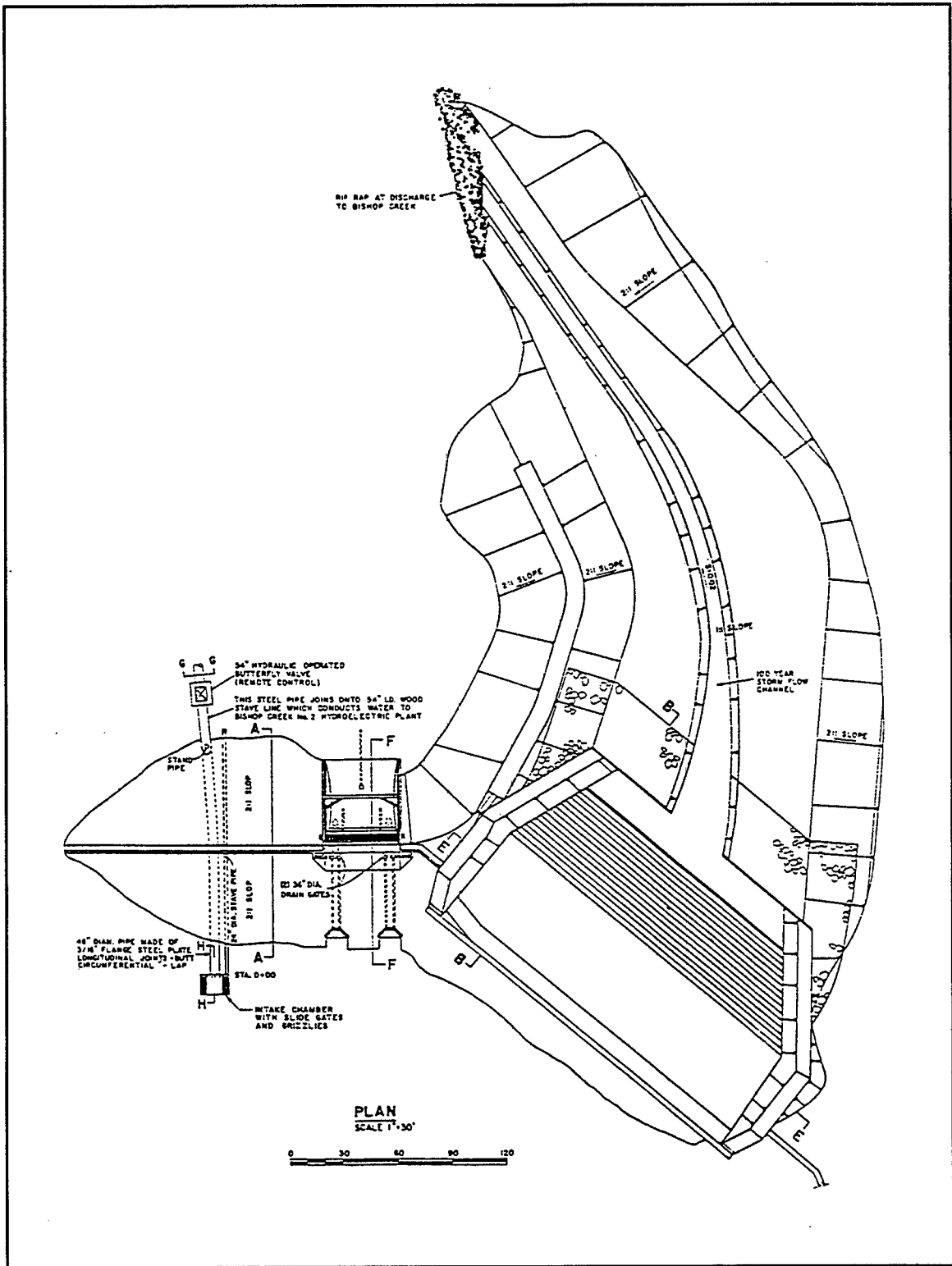

Figure 27. Drawing of RCC spillway constructed at Bishop Intake No. 2 (courtesy of Throckmorton and Knarr 1991, ASCE)

Work was completed in October 1989 (Figure 28) at an approximate cost of \$958,973. This cost is estimated to be about \$500,000 less than the cost for a structural concrete spillway.

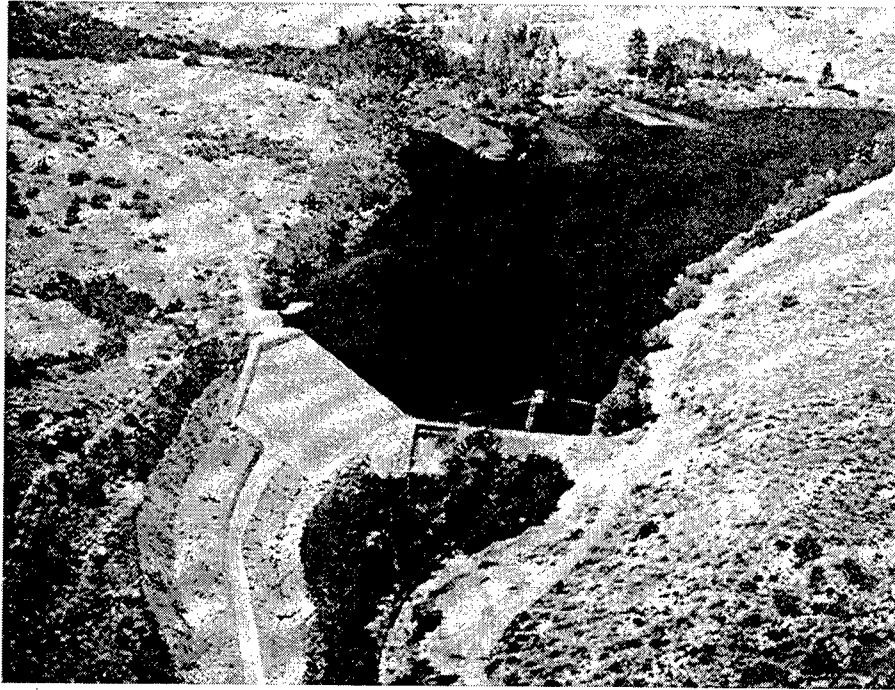

Figure 28. Completed RCC spillway at Bishop Intake No. 2 (courtesy of Throckmorton and Knarr 1991, ASCE)

### Boney Falls Dam

Boney Falls Dam, which was constructed during 1920 and 1921, is located on the Escanaba River approximately 40 km (25 miles) upstream of Lake Michigan. The dam is a part of the Boney Falls hydroelectric project, which supplies power to the Mead Corporation's paper mill. The project consists of two embankment dams, one 91.4 m (300 ft) long and the other about 1,710 m (5,600 ft) long, a nonoverflow gravity dam, a three-unit powerhouse with a 4.2-MW generating capacity, a tainter-gated spillway, and a 61-m- (200-ft-) long ungated spillway. Normal operating head on the powerplant is about 15 m (50 ft) (Baier 1989).

During a routine 5-year safety inspection, the Federal Energy Regulatory Commission (FERC) determined that the discharge capacity of the two spillways — 934 cms (33,000 cfs) — could not handle the calculated PMF peak discharge of 4,163 cms (147,000 cfs). Subsequent analyses indicated that discharges greater than 2,832 cms (100,000 cfs) would produce minimal incremental downstream damage as a result of a dam failure. Therefore, it was concluded that the additional spillway capacity required was about 1,900 cms (67,000 cfs). Four alternative designs were considered to achieve this additional capacity (Marold 1992). Preliminary studies indicated construction of an uncontrolled overflow spillway in the left embankment and protection of the

downstream side of the embankment with RCC would be the best option for economic and technical reasons (Figure 29).

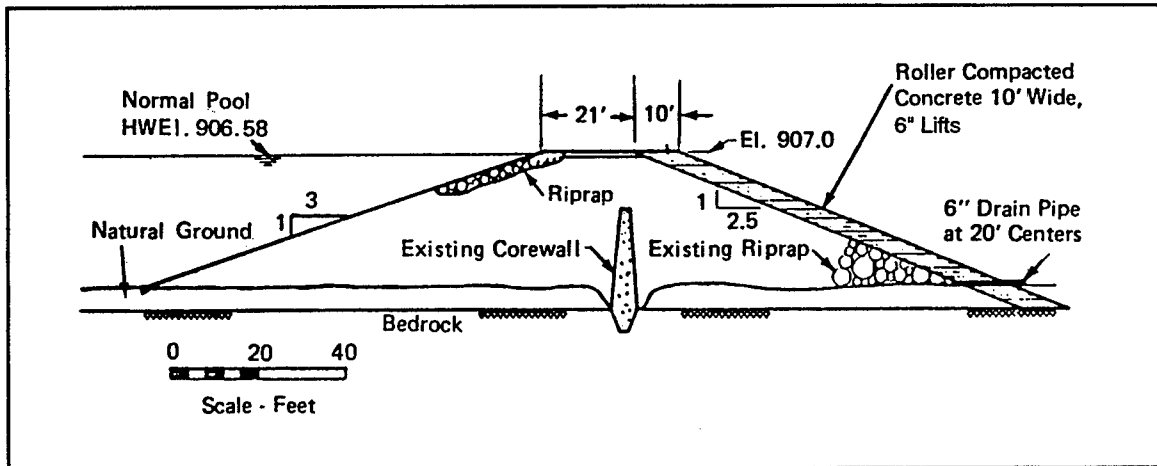

Figure 29. Cross section of the overflow spillway and RCC embankment protection at Boney Falls Dam (courtesy of Marold 1992, ASCE). (Multiply inches by 25.4 to obtain millimetres and feet by 0.3048 to obtain metres)

Further inspections uncovered significant leakage through the left embankment, and another inspection during a time the reservoir was drawn down revealed sink holes in the area upstream of the left embankment. A follow-up geotechnical investigation determined that seepage pressures could result in piping of the embankment fill material, which in turn could result in failure of the dam even with RCC paving on the downstream side of the dam. However, the proposal to stop and/or control this seepage with an extensive grouting program was rejected as being too costly. Instead, a decision was made to remove and replace the entire downstream section of the dam with an RCC emergency spillway. This plan provided several advantages: the foundation rock below the dam could be inspected and treated; the core wall could be exposed and used in the new construction; converting the concrete-core earth-fill structure into a concrete gravity structure would eliminate the potential for piping; the RCC gravity section would serve as an emergency spillway section to provide increased spillway capacity; and the RCC gravity section could withstand uplift pressures below the bottom of the structure without overturning (Marold 1992).

To avoid a substantial seepage path that was located below the north-south section of the dam, the contractor decided to shorten the spillway section from 304.8 to 152.4 m (1,000 to 500 ft). This change meant the crest of the RCC gravity section had to be lower to carry the same volume as the longer paved RCC designed section. The revised plan called for the crest of the new RCC emergency spillway to be set 0.3 m (1 ft) below normal pool and to be covered with 1.2 m (4 ft) of earth fill, which would serve as an erodible fuse plug. The earth fill over the spillway would wash out when the reservoir water came within 152 mm (6 in.) of the dam crest. The fuse plug would lower the reservoir by only 0.3 m (1 ft) and would require a short reconstruction time were it to wash

out (Marold 1992). The spillway was to be 152 m (500 ft) long, 4.9 m (16 ft) high, 6.4 m (21 ft) wide at the base and 3.4 m (11 ft) wide at the top (Figure 30).

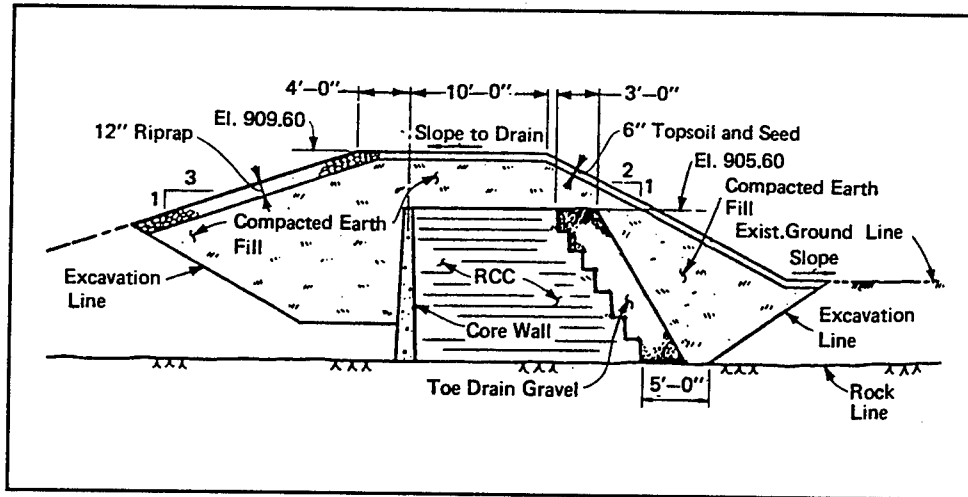

Figure 30. RCC spillway section with erodible earth-fill crest, Boney Falls Dam (courtesy of Marold 1992, ASCE). (Multiply inches by 25.4 to obtain millimetres and feet by 0.3048 to obtain metres)

Several trial mixtures of RCC were made in the laboratory with locally available materials. All mixtures were vibrated in a 0.014-cu m (0.5-cu ft) mold fixed to a vibrating table with a frequency of 3,600 rpm. No weight was used on top of the mixture in the mold. The Vebe vibration time was determined as the time in seconds required to produce a continuous ring of mortar around the inside of the mold. Mixtures with Vebe times of 20 to 30 sec were judged to have optimum consistency. During testing of the mixtures, it was apparent that the Class C fly ash to be used contributed significantly to strength gain compared to a typical Class F fly ash. Therefore, corrections were made in the mixture proportions to account for this effect. Natural sand and minus 19-mm (3/4-in.) crushed limestone aggregates were used. The selected mixture proportions for the RCC were as follows:

Material	Weight, kg/cu m (lb/cu yd)
Portland cement (Type I)	98.5 (166)
Fly ash (Class C)	83.1 (140)
Water	117.5 (198)
Fine aggregate	792.0 (1,335)
Coarse aggregate	1,337.9 (2,255)

A test fill was constructed in September 1989 just prior to starting the RCC placements. The contractor used a portable pugmill mixer designed primarily for road base material. After experiencing some difficulty loading out the design mixture at the normal plant output of 170.5 cu m (223 cu yd) per hour, the mixture proportions were revised to the following:



Material	Weight, kg/cu m (lb/cu yd)
Portland cement (Type I)	88.4 (149)
Fly ash (Class C)	109.2 (184)
Water	109.2 (184)
Fine aggregate	789.1 (1,330)
Coarse aggregate	1,337.9 (2,255)

The revised mixture, which was used throughout the RCC placement, was slightly stiffer and eliminated problems with premature discharge of the RCC off the conveyor. RCC cylinders from the test fill exhibited compressive strengths of 15.8 and 30.5 MPa (2,290 and 4,420 psi) at 7 and 28 days, respectively. Cores taken from the test fill at 37-days age exhibited a compressive strength of 31.0 MPa (4,490 psi) at 37 days.

Prior to placement of the RCC, the earthfill behind the corewall was removed down to bedrock. The core wall was raised from 0.6 to 3.7 m (2 to 12 ft) and extended the entire length of the spillway to serve as a form for the upstream RCC and as an impervious lining to reduce potential leakage through the lift joints. The surface of the bedrock was cleaned, and approximately 76.2 mm (3 in.) of a conventional concrete bedding mixture was placed on the bedrock to fill voids and help bond the RCC to the rock.

The RCC was transported in dump trucks and spread with a D-8 dozer (Figure 31). To minimize segregation, whenever possible the RCC was dumped

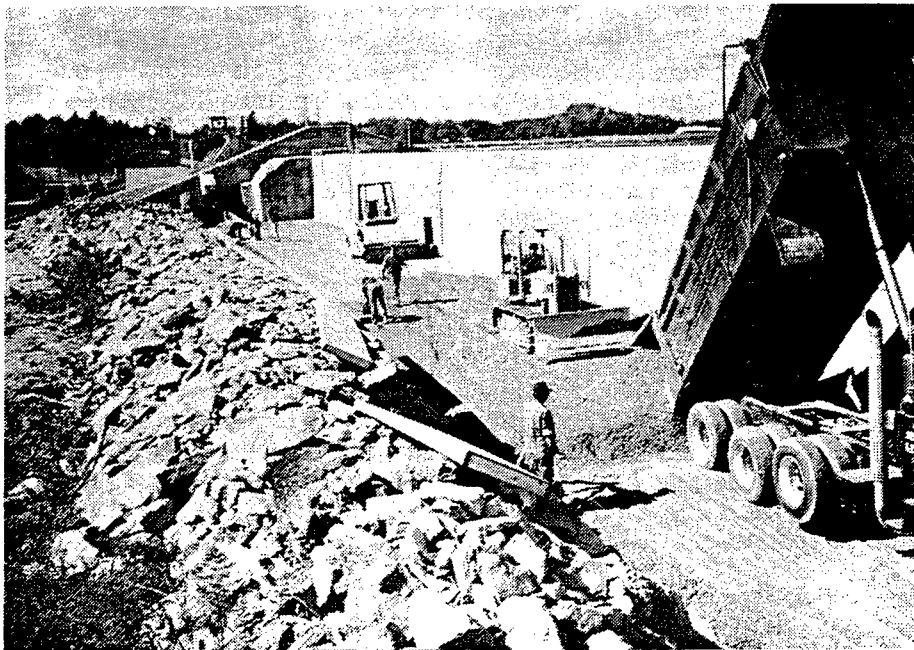

Figure 31. Placement of RCC adjacent to existing concrete core, Boney Falls Spillway (courtesy of Marold 1992, ASCE)

on concrete that had been spread but not compacted. Generally, two 0.3-m- (1-ft-) thick lifts of RCC were placed simultaneously each day. The specifications required that the bedding mixture be used on lift joints that were exposed for more than 12 hr. However, this requirement was eliminated after the third day of placement because tracking of the mixture on the truck tires was interrupting placement procedures. Also, there were no visible joints in the test fill where no bedding mixture was used. A 9,070-kg (10-ton) vibratory roller was used to compact the RCC, except near the forms and core wall where hand-held vibratory compactors were used (*RCC Newsletter* 1990). Wooden jump forms, 0.6-m- (2-ft-) high supported by bracing wires embedded in the previous day's placement were used on the downstream face of the RCC.

Vibration tests were performed at the beginning of each day and whenever there was a question to determine the consistency and uniformity of the RCC. Results of these tests were used to adjust the water content of the RCC mixture. The average vibration time was approximately 30 sec; however, any time between 20 and 40 sec was acceptable. Unit weight measurements were made from each vibration test specimen and results were compared with the theoretical for uniformity. Also, the percent of coarse aggregate in the mixture was checked daily (*RCC Newsletter* 1990).

Water and plastic sheets were used for curing. The RCC was sprayed with water during placement if it appeared to be excessively dry and before a new lift was begun. The RCC was covered with plastic sheets immediately following compaction of the second lift each day (*RCC Newsletter* 1990).

The approximately 3,820 cu m (5,000 cu yd) of RCC used in the spillway section was placed in 8 days. When placement was completed, full-depth cores were taken from the spillway section for testing. Concrete in the cores was 97 percent solid without air voids or honeycombs. Seven of eleven cold joints had bonded without the use of a bedding mixture. Bonding was also achieved in five of seven cold joints where the bedding mixture was used. The two joints that did not bond were at the rock surface where the rock was thinly bedded and water seepage in rock joints had occurred during placement (*RCC Newsletter* 1990).

Approximately 1 year after construction, measurements of water levels in three observation wells and measurements of leakage through the gravel drainage layer on the downstream side indicated that the RCC spillway has effectively reduced the headwater across the foundation level by 60 to 100 percent and is performing successfully (Marold 1992). The completed RCC spillway is shown in Figure 32.

The cost for the RCC was \$290,000, or about \$76/cu m (\$58/cu yd). Additional costs associated with construction of the spillway amounted to approximately \$133,400, or \$37/cu m (\$28/cu yd), making the total cost of the project about \$112/cu m (\$86/cu yd) (Marold 1992).

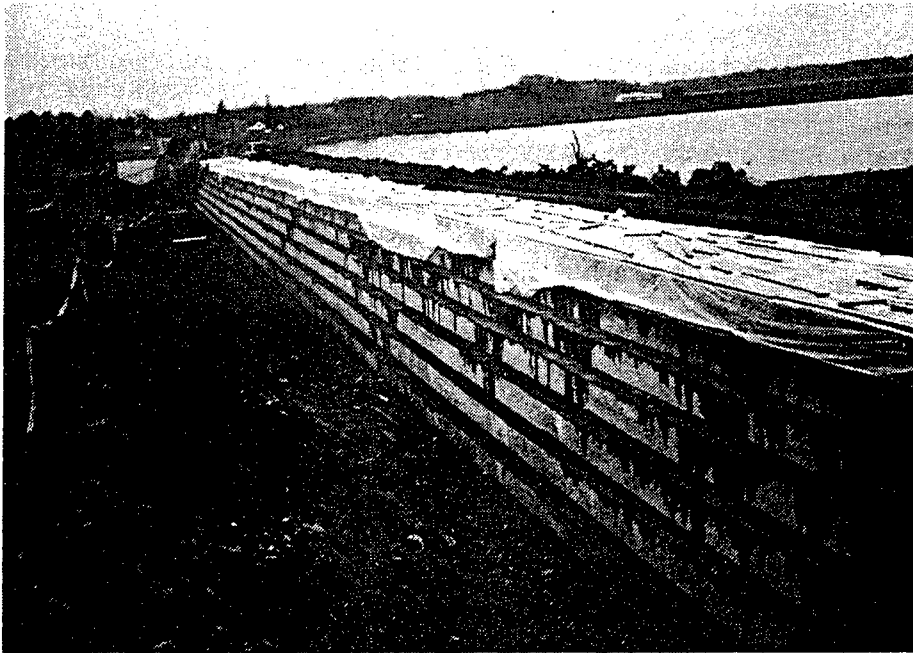

Figure 32. The completed RCC emergency spillway at Boney Falls (courtesy of Marold 1992, ASCE)

### Tellico Dam

Tellico Dam, on which construction began in 1967 and was completed in 1979, forms a reservoir near Lenoir City, TN. Completion of the dam was the culmination of a 12-year battle with environmentalists over the snail darter, a 76-mm- (3-in.-) long fish on the endangered list whose habitat was the area around the dam. Studies indicate construction of the dam was not detrimental to the snail darter.

In 1988-1989, the Tennessee Valley Authority (TVA), as part of its on-going dam safety program, concluded that the saddle dam along the reservoir would be susceptible to overtopping and potential failure in the event of the PMF. To prevent dam failure in such an event, TVA decided to replace part of the saddle dam with an RCC emergency spillway (*RCC Newsletter* 1989b). The new ungated spillway is 609.6 m (2,000 ft) long, 3.2 m (10.5 ft) high, and 2.4 m (80 ft) wide. It has an uncontrolled ogee crest of conventional reinforced concrete and slotted end sills or baffle dikes (Figure 33). The crest elevation is at the approximate level of the PMF. The width of the ogee section is 5.63 m (18.48 ft), and the height of the crest is 4.11 m (13.5 ft) from the bottom of the shear key. A horizontal apron-type energy dissipator extends 18.75 m (61.52 ft) downstream of the ogee section; a 0.6-m-, 76-mm- (2-ft-, 3-in.-) high by 4.3-m- (14-ft-) wide endsill at the downstream end of the apron provides additional energy dissipation. RCC was selected for construction of the apron, endsill, and spillway section.

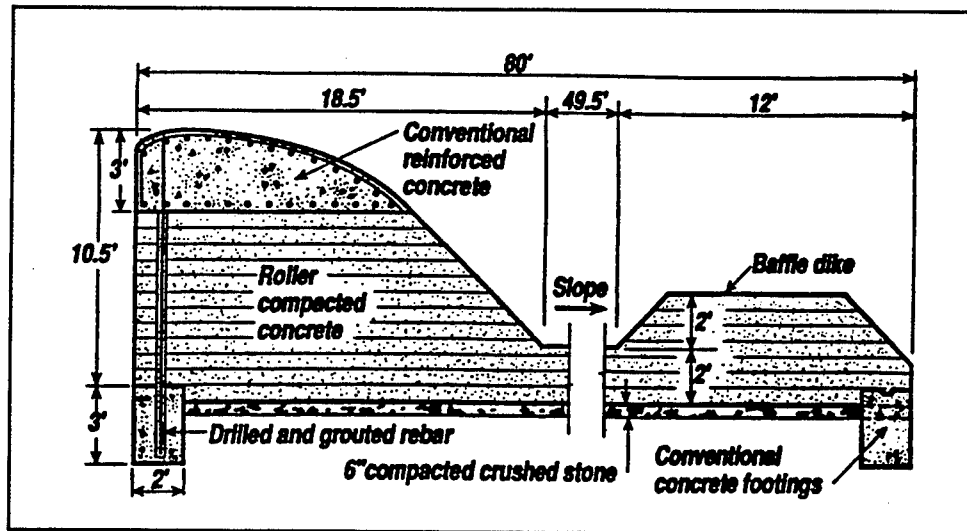

Figure 33. Emergency spillway, Tellico Reservoir Saddle Dam (courtesy of *RCC Newsletter* 1989b)

Placement of the RCC was scheduled for late fall and early winter of 1988 to 89. Construction began with the excavation of the saddle dam. Then subsurface drains to collect seepage from the interior drains of the Saddle Dam, the drain under the spillway and apron, and the trenches for shear keys at the upper and lower ends of the spillway and apron and at other low spots in the rim area were installed.

The RCC mixture was proportioned based on a review of the RCC mixture used at TVA's Little Bear Creek Dam in 1986 and 1987. The RCC mixture was proportioned with 19-mm (3/4-in.) maximum size aggregate to achieve a minimum compressive strength of 20.7 MPa (3,000 psi) at 90 days. Mixture proportions were as follows:

Material	Weight, kg/cu m (lb/cu yd)
Portland cement	148.3 (250)
Fly ash	112.7 (190)
Fine aggregate	789.1 (1,330)
Coarse aggregate	1,329.0 (2,240)
Water	112.7 (190)

The RCC was batched in a plant at nearby Lenoir City. It was mixed in a 4.6-cu-m (6-cu-yd) conventional stationary drum for approximately 90 sec, released into rear-dump trucks, and delivered to the project. RCC production averaged about 84.1 cu m (110 cu yd) per hr (*RCC Newsletter* 1989b).

The RCC was placed by TVA's own construction force. In the stilling-basin section, the RCC was spread with a grader in layers approximately 254 mm (10 in.) thick and 3.1 m (10 ft) wide. An end loader was used to spread the RCC

in the restricted area between the dam and baffle dikes. The RCC was placed in 15.2-m- (50-ft-) long strips beginning at the left retaining wall and working toward the right retaining wall. Approximately 122- to 152-m (400- to 500-ft) segments of a single lift were accomplished each day. A 9,070-kg (10-ton) vibratory roller was used for compaction, except for the area near the retaining walls, where pneumatic hand tampers were used. At the beginning of new segments, the top 127 mm (5 in.) of the cold joint was saw cut, and the remainder of the lift was broken off with pavement breakers.

Wooden forms were devised to facilitate RCC placement on the curved portion of the spillway and on the slopes of the baffle dikes. The RCC was compacted against the forms with hand labor and pole tampers. This detail increased cost but resulted in a reasonably smooth surface. The RCC was effectively cured by being covered with plastic sheets for 7 days. Tests indicated the compressive strength of the RCC was generally in the range of 20.7 to 34.5 MPa (3,000 to 5,000 psi) and densities were in the range of 2,400 to 2,480 kg/cu m (150 to 155 lb/cu ft).

Approximately 15,000 cu m (19,600 cu yd) of RCC was required for the placement which began in October 1988 and was essentially complete in December 1988. Total cost of the RCC, including materials and placement was about \$52/cu m (\$40/cu yd). The completed spillway is shown in Figure 34.

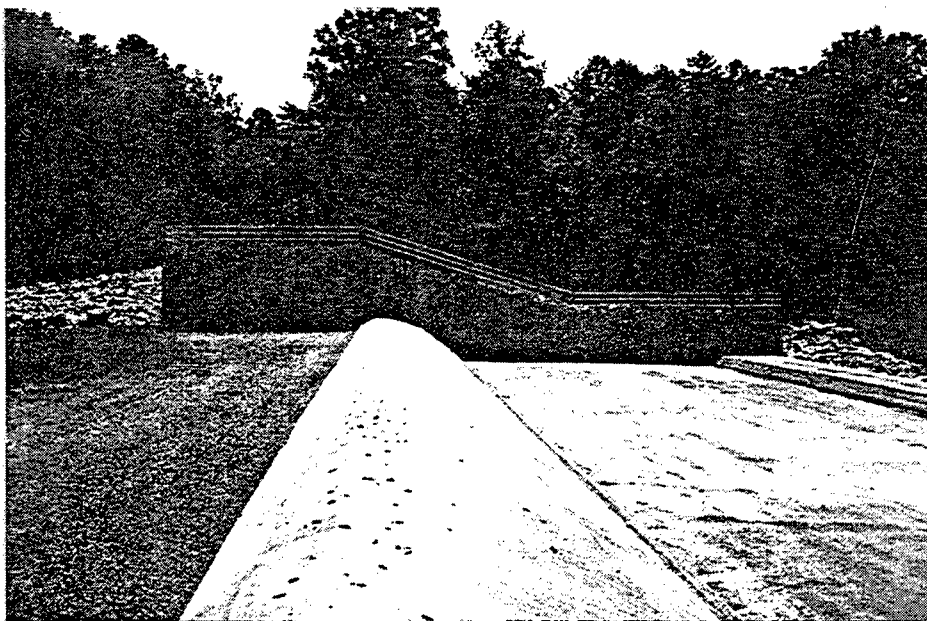

Figure 34. Portion of completed spillway, Tellico Reservoir Saddle Dam

## Gibraltar Dam

Gibraltar Dam was constructed in Santa Barbara County, California, 1920 through 1922. The concrete arch dam is located on the Santa Ynez River in a wilderness area that is part of the Los Padres National Forest. The dam crest is 182.9 m (600 ft) long. Its constant radius arches vary in thickness from 2.1 m (7 ft) at the crest to about 19.8 m (65 ft) at the base. In 1948 the dam was raised to its current maximum height of 59.4 m (195 ft) to increase storage capacity for the municipal water supply for the City of Santa Barbara. The dam impounds approximately 10,485,000 cu m (8,500 acre-ft). The capacity of the radial-gated spillway is approximately 2,550 cms (90,000 cfs).

In 1983, Gibraltar Dam was evaluated to determine whether it could withstand a maximum credible earthquake (MCE) or a PMF. The evaluation was based upon new seismic loadings developed after the 1972 San Fernando earthquake and new structural analysis techniques. The evaluation indicated the dam could fail in case of an MCE event because it could not withstand the high tensile stresses the earthquake would induce. The California Division of Safety of Dams and the Federal Energy Regulatory Commission mandated that the dam be strengthened. The City of Santa Barbara agreed to the mandate. This case history is a summary of a report on the rehabilitation of Gibraltar Dam by Wong et al. (1992).

Alternatives considered for strengthening the dam included overlaying both faces of the dam with either reinforced concrete or shotcrete, constructing a reinforced rock-fill buttress against the downstream face, or building an RCC buttress against the downstream face. The RCC alternative was selected because it would change the arch dam into a curved gravity dam, thus altering the dynamic response characteristics of the dam and enabling it to withstand the stress induced by an earthquake; it would reduce construction cost because it would require less construction time than the other options and less material because RCC can be placed at a steeper angle than either conventional concrete or rock-fill embankments; it would allow for future raising of the dam if siltation created such a need (The design cross section was developed to accommodate a 6.1-m (20-ft) raise.); it could be more easily accomplished in the restricted project site; placement of RCC on the downstream face of the dam would not interrupt operation of the dam, and the RCC would have less environmental impact than other methods. Design elements for the project included the geometry of the buttress, the RCC mixture proportions that would meet strength specifications, methods for bonding the RCC to the existing structure, a drainage system, and instruments for monitoring the new gravity structure.

The RCC for the project was developed as a "soils-approach" mixture. Preliminary mixture proportions, based on U.S. Army Corps of Engineers guidelines, were refined in trial mixture and test-fill studies. Cylinder and core samples from a 1986 test fill confirmed that the mixture proportions would produce the required 1-year splitting tensile strength of 2.1 MPa (300 psi) and a corresponding compressive strength of 15.9 MPa (2,300 psi). Fly ash was included in the mixture to reduce heat generation in the massive buttress and to mitigate the potential effects of marginally reactive aggregates from the onsite

borrow source. To reduce thermal stresses in the RCC buttress, specifications for the RCC heat of hydration were that it was not to exceed 293.3 J per kg (70 calories per gram). Since cement suppliers in the project area did not test for heat of hydration, a chemical requirement that limits the amount of tricalcium silicate and tricalcium aluminate ( $C_3S + C_3A$ ) in cement to 58 percent would be used to provide an approximate measure of heat of hydration. Chemical analyses of the cement used in the project indicated 50 to 59 percent ( $C_3S + C_3A$ ). One RCC mixture was used for the entire buttress. RCC materials and mixture proportions were as follows:

Material	Weight, kg/cu m (lb/cu yd)
Portland cement (Type II, low alkali)	89.0 (150 lb)
Fly ash (Class F)	53.4 (90 lb)
Water	142.4 (240 lb)
Coarse aggregate (38-mm (1-1/2-in.) MSA, SG = 2.58, absorption = 2.5%)	1,234.1 (2,080 lb)
Fine aggregate (SG = 2.5, absorption = 3%)	795.0 (1,340 lb)

The theoretical unit weight of the RCC, assuming 1 percent air voids, was 85.4 kg/cu m (144 lb/cu ft).

The RCC buttress increased the width of the dam crest by 4 m (13 ft). The face of the buttress is vertical for the top 3 m (10 ft) and then slopes at 0.8H:1V to the toe (Figure 35). The structural analyses of the RCC buttress were based on the assumption that the strengthened dam will respond to loading as a monolithic structure. Provisions required to ensure adequate bonding between the existing dam and the RCC buttress included sandblasting the downstream face of the existing dam, placement of a zone of conventional concrete at the interface, and installation of interface drainage pipes. A drainage gallery system (Figure 36) was included within the RCC buttress to allow for collection of inflows from the interface drains, foundation drains, and buttress drains and for monitoring and maintenance of the drainage system.

Instrumentation was included in the buttress design to monitor the performance of the strengthened dam. Thermocouples were installed at various locations between RCC lifts so that changes in temperature could be monitored. Crack detection meters were installed at the interface between the existing dam and the RCC buttress to detect and monitor any separation at the interface and any radial cracking. Piezometers were installed from the lower adit to monitor uplift pressures in the buttress foundation.

To prepare the foundation and abutments for placement of the RCC, workers excavated the area to sound rock with pry bars and light jackhammers. The rock surfaces were then cleaned with water and high-pressure air jets. Dental concrete was used as necessary to smooth significant irregularities and to fill in small

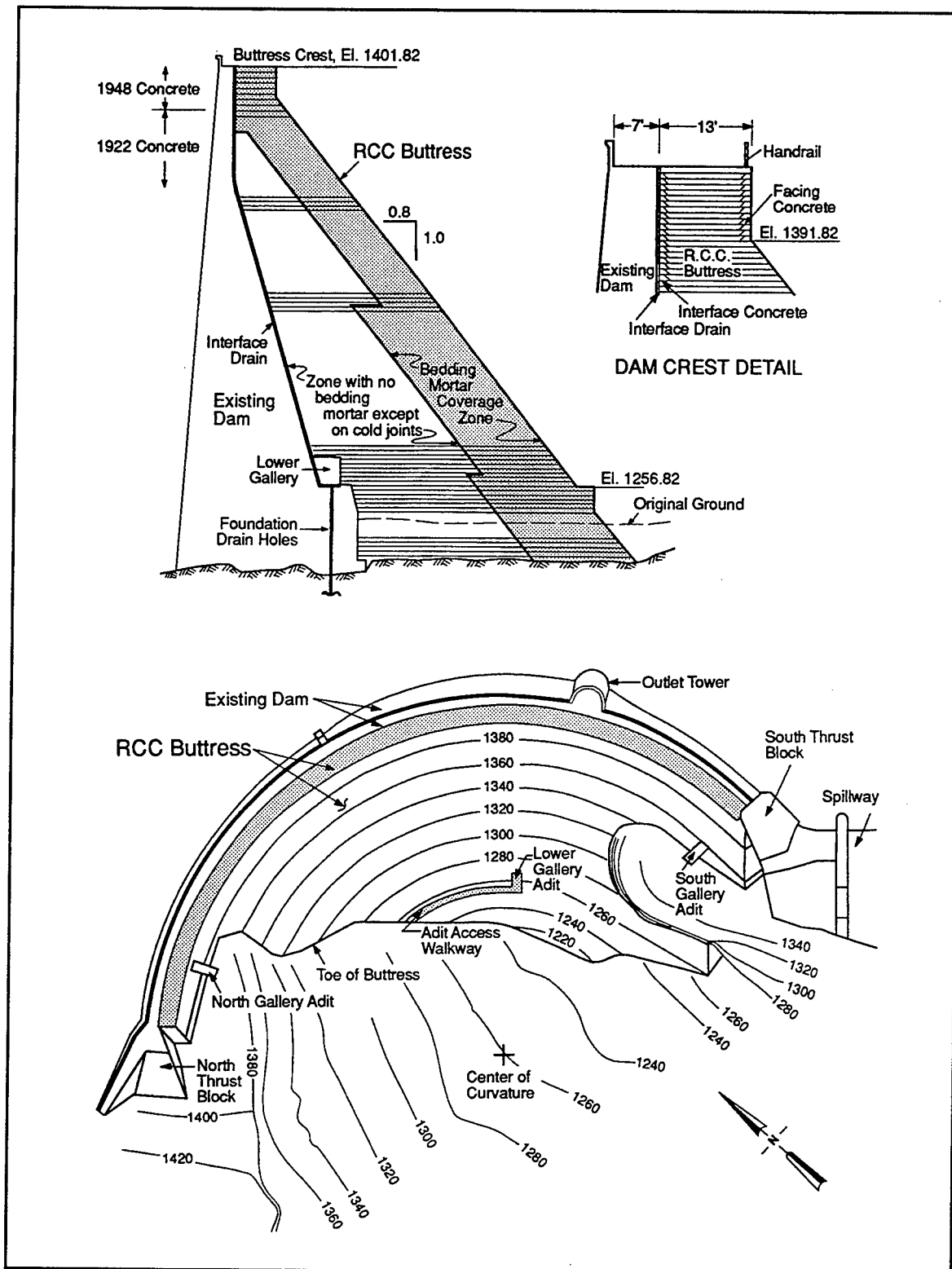

Figure 35. Cross section and plan of RCC buttress, Gibraltar Dam (courtesy of Wong et al. 1992, ASCE)



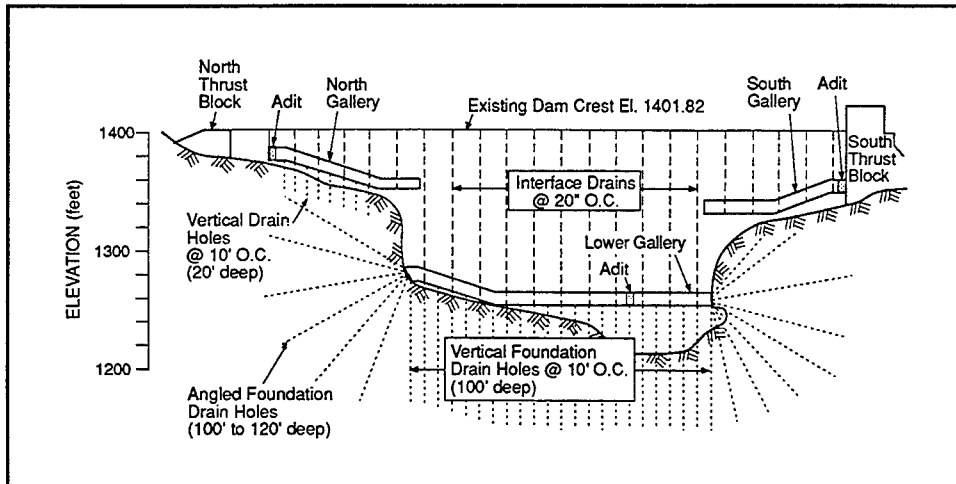

Figure 36. Layout of drainage system, Gibraltar Dam (courtesy of Wong et al. 1992, ASCE). (Multiply feet by 0.3048 to obtain metres)

overhangs. A 51 to 102-mm (2- to 4-in.) layer of bedding concrete was applied immediately prior to RCC placement to ensure good bond between the RCC and rock surfaces.

The RCC was mixed in an Erie Strayer conventional-concrete single-drum computer-automated batch plant. The plant, located about 0.4 km (1/4 mile) downstream of the dam, had a peak capacity of about 92 cu m (120 cu yd) per hr with a 120-sec mixing time. Since specifications limited the temperature of the RCC to 21 deg C (70 deg F), the contractor used a water chiller and insulated storage pond for mixing water and for cooling aggregate stockpiles and a system for injecting liquid nitrogen into the mixer during batching of the RCC. Within 10 to 15 min after being mixed, the RCC was delivered to the site in dump trucks. Several different sizes of dozers were used to spread the RCC in 0.3-m- (1-ft-) thick lifts, depending on the size of the lift area (Figure 37). Compaction was accomplished with a 9,070-kg (10-ton) double-drum vibratory roller, with assistance from smaller rollers in more confined areas and adjacent to lift edges.

Thorough compaction was essential at the interface of the existing structure and the RCC. The fluid nature of interface concrete (25- to 102-mm (1-to 4-in.) slump) was such that the 9,070-kg (10-ton) vibratory roller did not effectively compact the RCC within 305 to 381 mm (12 to 15 in.) of the existing dam. Therefore, the contractor used a one-man gas-powered "wacker"-type tamper, vibrating sled compactors, and small 1,810- to 2,720-kg (2- to 3-ton) dual-drum vibratory rollers in these areas. A vibratory plate compactor mounted on a rubber-tired backhoe (Figure 38) was used to smooth and compact the sloped, unformed portions of the downstream face.

Field monitoring was continuous throughout construction. Workers monitored materials and mixing, moisture consistency, moisture content, uniformity of the RCC mixture, temperature of the mixture prior to compaction, in-place density, and time lapse between mixing and placing. Adjustments were made as

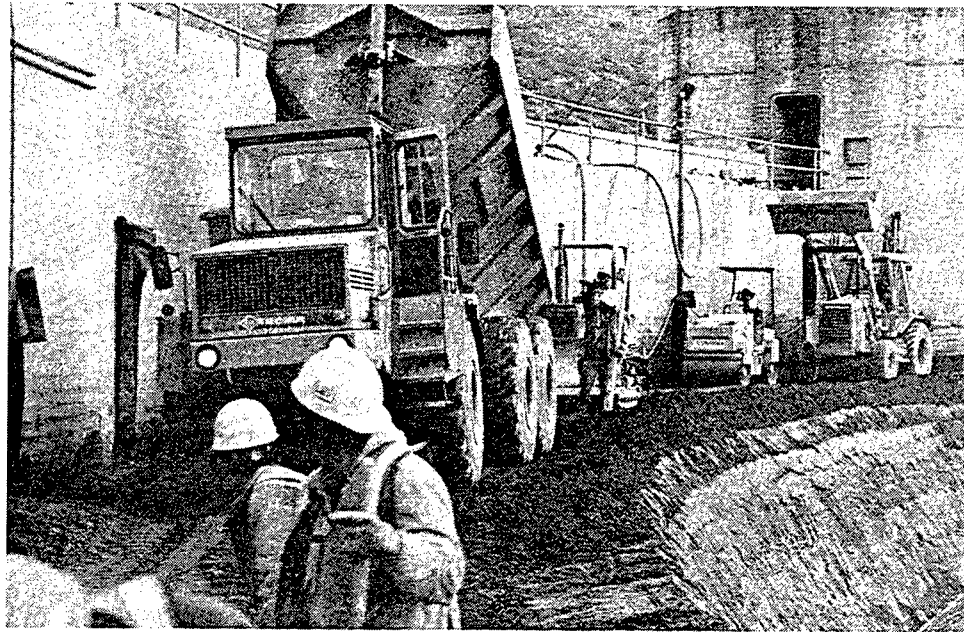

Figure 37. Smaller dozers at work in narrow placement area near the top of the buttress at Gibraltar Dam (courtesy of Wong et al. 1992, ASCE)

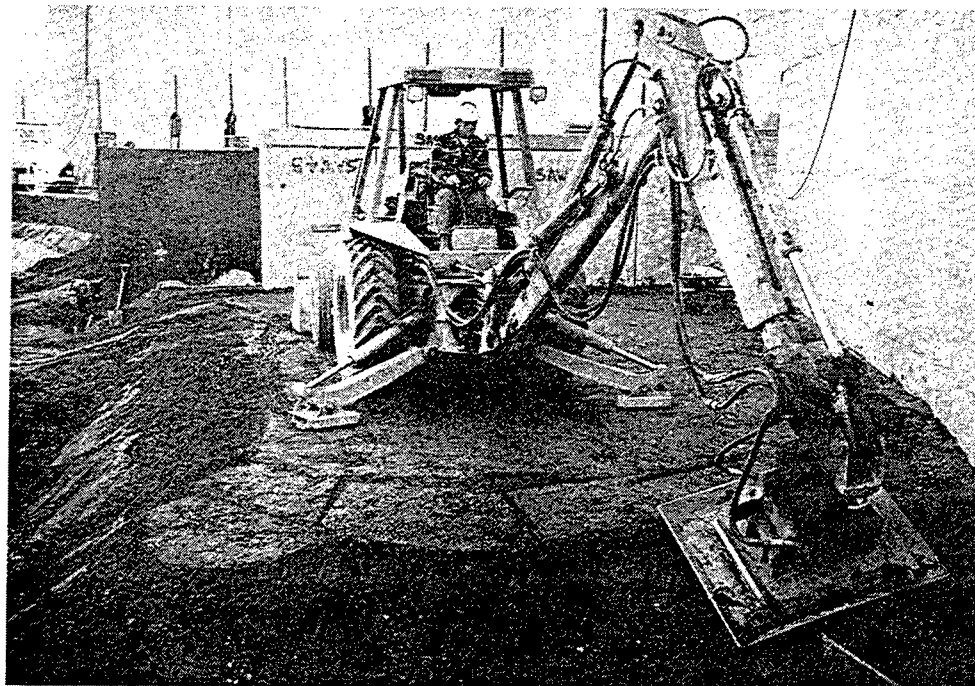

Figure 38. Slope compactor being used at Gibraltar Dam (courtesy of Wong et al. 1992, ASCE)

necessary. Field cylinders for strength testing were prepared from RCC samples taken each shift. Results of early-age tests indicated that the compressive strength of the mixture would exceed 15.9 MPa (2,300 psi) in 1 year. Results of nuclear gauge density testing during construction indicated that the desired densities were consistently achieved. Field test results typically varied from 2,227 to 2,307 kg/cu m (139 to 144 pcf) wet density.

RCC placement rates varied widely, depending on the width of the lift surface. The narrower the lift area, the slower the placement. The best week of RCC production was in early November when 10,630 cu m (13,900 cu yd) was placed in 5 days. Overall, the average production for a 10-hr shift was just over 765 cu m (1,000 cu yd) with a maximum production of 1,321 cu m (1,728 cu yd). A total of 71,100 cu m (93,000 cu yd) of RCC was placed between October 1 and December 22, 1990. The completed project is shown in Figure 39.

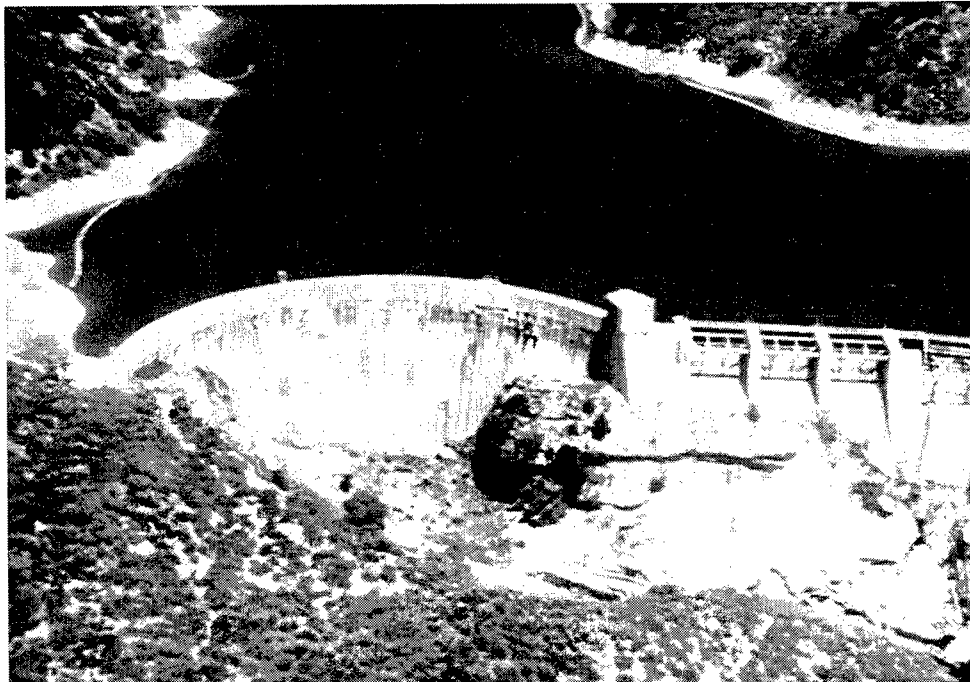

Figure 39. Gibraltar Dam after being strengthened with an RCC buttress (courtesy of Wong et al. 1992, ASCE)

### **Kemmerer City Dam**

The Kemmerer City Reservoir, located on the Hams Fork River in southwestern Wyoming, provided water for the cities of Kemmerer, Diamondville, and Frontier until it was replaced by the 51,807,000-cu-m (42,000-acre-ft) Viva Naughton Reservoir in 1959. The 1,974,000-cu-m (1,600-acre-ft) Kemmerer City Reservoir subsidizes the cities' water supply in dry years, but it is used primarily for recreation and as a brood stock trout fishery. It is an important source of tourism dollars for Kemmerer City.

The Kemmerer City Dam is an earth embankment, approximately 9.1 m (30 ft) high and 259.1 m (850 ft) long. A 20.7-m- (68-ft-) wide broadcrested spillway is located at the left abutment. The outlet works consists of two 914-mm- (36-in.-) diam pipes that are operated infrequently. Two 356-mm- (14-in.-) diam pipes that interfaced with the local water system are no longer in operation.

A 1978 inspection of the dam by the Corps of Engineers raised questions about the condition of the dam and outlet works and the ability of the dam to pass the design flood. A 1984 seismic study showed the area was at greater risk from earthquakes than had been previously thought. A Level II feasibility study performed in 1986 evaluated two options: rehabilitate the dam to pass the design flood or decommission the dam. Needing the money generated by the reservoir through recreation, the City of Kemmerer asked the Wyoming Water Development Commission to provide funding for rehabilitating the dam.

In 1988 a final design study was begun (Johnson, Locke, and Oritz 1989). The study included hydrologic analyses to develop a design flood based on the PMF, hydraulic analyses to determine the impact of floods on the dam and the area downstream of the dam, liquefaction analyses to determine the effect of the MCE on the dam, and field investigations to determine the strength of the bedrock joints, the density of the embankment, and the internal geometry of the dam. Results of the investigation showed that in the event of the MCE, the dam would not fail, and the damage that would occur could be repaired. Also, the study showed it would be impractical to design the dam to safely pass the PMF; one-half the PMF was selected for design.

Rehabilitation alternatives considered for Kemmerer City Dam included (a) combining the outlet works and spillway into one concrete structure and rebuilding the slopes of the dam to improve seismicity, (b) raising the dam crest, and (c) constructing an RCC emergency spillway section. Cost was a determining factor in the choice of a rehabilitation method. The RCC option was selected. Plans were prepared for constructing a 121.9-m- (400-ft-) long RCC emergency spillway (Figure 40) and upgrading the existing spillway. Together the two spillways will be able to carry one-half the PMF with 1.2 m (4 ft) of head and 0.3 m (1 ft) of freeboard on the dam. The outlet works will not be replaced; instead the existing conduits and gates will be improved.

The planned repairs will not upgrade the dam to meet new dam safety criteria, but they will improve the safety of the dam to meet the needs of the owners. Total costs for the repairs including engineering, design, construction, and construction administration were estimated to be approximately \$825,000, less than one-half of the cost of some of the other alternatives.

Approximately 3,140 cu m (4,100 cu yd) of RCC was required to construct the emergency spillway in 1990. The unit cost of the RCC, which included 147 kg/cu m (248 lb/cu yd) of cement was \$98.17/cu m (\$75.06/cu yd).

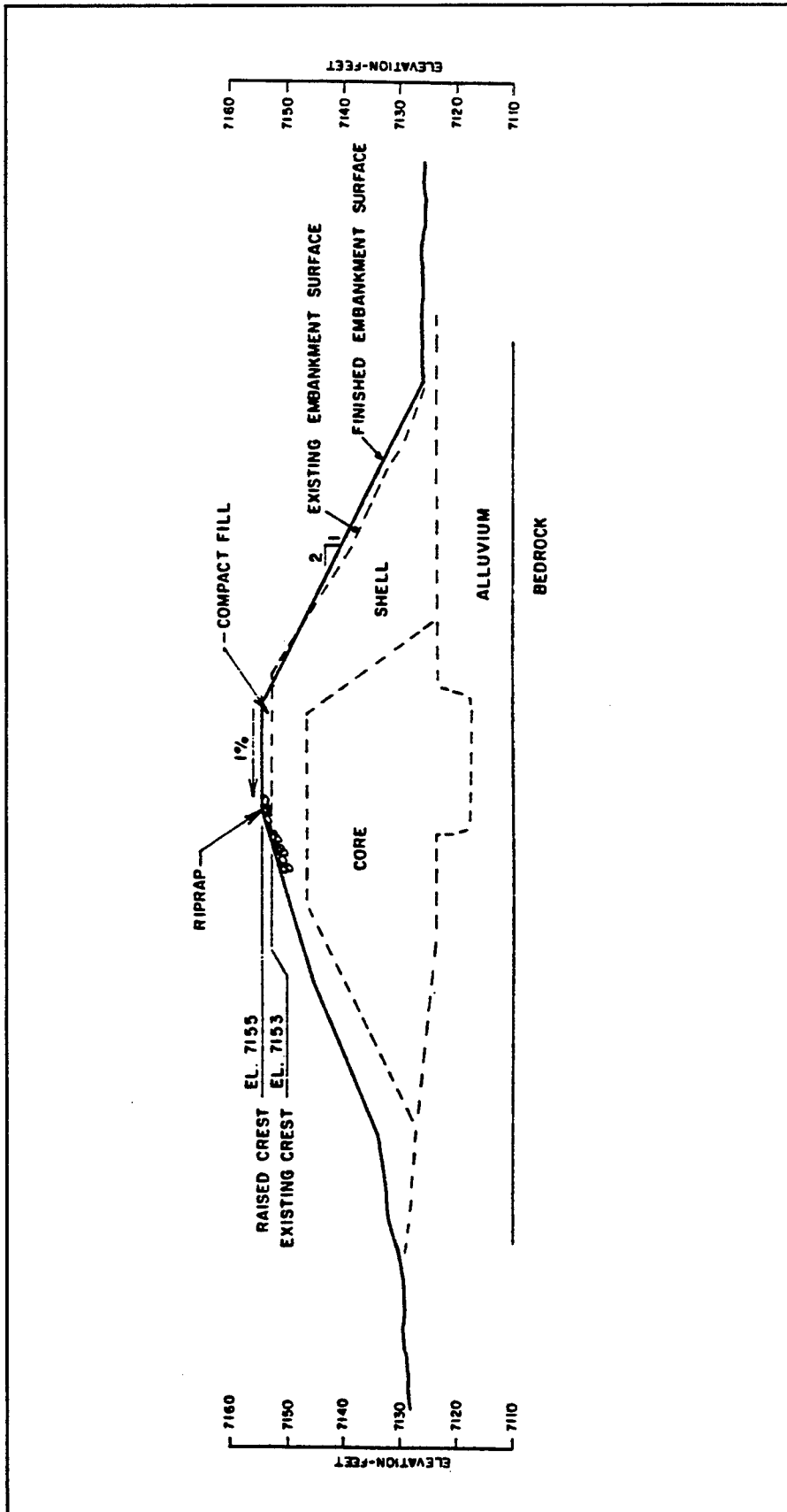

Figure 40. RCC emergency spillway at Kemmerer City Dam (courtesy of Johnson, Locke, and Ortiz 1989, ASDSO)

## Nickajack Dam

Nickajack Dam was one of 21 dams the TVA targeted for review in 1979 when it began a reevaluation program of its older dams. The dam, which is located in Marion County, Tennessee, approximately 73 km (45 miles) downstream from Chattanooga, was constructed in the mid-1960s. Nickajack Dam is 24.7 m (81 ft) high and 1,148.2 m (3,767 ft) long. Both the north and south embankments are impervious rolled earth fill. The dam impounds a reservoir volume of 311,333,000 cu m (252,400 acre-ft) at el 194 m (635 ft).

Hydraulic studies conducted during the reevaluation indicated that overtopping of the embankments would occur in floods exceeding 50 percent of the PMF. Larger floods would produce overtopping of sufficient depth and duration to breach and fail the embankments (Newell, Manson, and Wagner 1991).

The TVA explored several alternatives for modifying the dam to pass the PMF:

- a. Increase the heights of the embankments. The embankments would need to be raised about 7.6 m (25 ft) to allow for wind wave runup. In addition, once raised, the north embankment would need an extra 182.9 m (600 ft) in length to tie into the north abutment. Cost would be approximately \$50 million.
- b. Increase the spillway capacity. Fourteen additional gated spillway bays would be needed to maintain the headwater level in a PMF at the existing embankment elevation. Estimated cost for this alternative was \$170 million.
- c. Increase spillway capacity and heights of the embankments at a cost of approximately \$105 million.
- d. Construct an RCC dam at the downstream toe of the north embankment and increase the south embankment to el 657. The top of the RCC dam would be el 634. Estimated cost for this method was \$14.5 million.
- e. Reduce the height of the north embankment, place RCC on the downstream slope, and increase the height of the south embankment. Cost estimate was \$16.8 million.

A decision was made to construct an RCC dam downstream of the north embankment (Figure 41) and to increase the height of the south embankment. During extreme floods, the north embankment would overflow and erode to the top of the RCC dam. The RCC dam would become an emergency spillway that would maintain the normal maximum pool in the reservoir (Newell, Manson, and Wagner 1991).

A concrete retaining wall was constructed on top of the south embankment to increase its height. Next, preliminary work was done in preparation for building

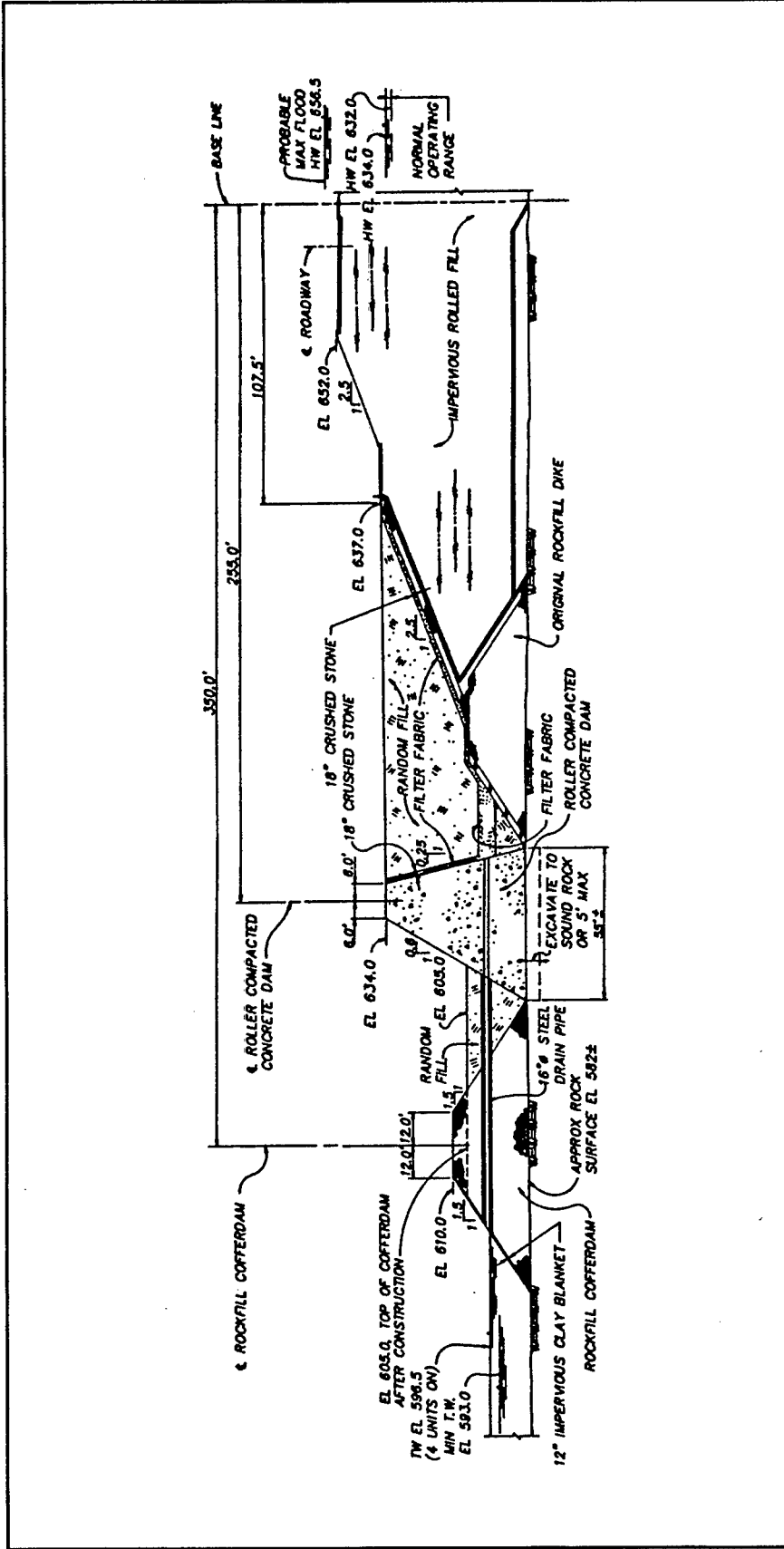

Figure 41. Right embankment modifications, Nickajack Dam (courtesy of Newell, Manson, and Wagner 1991, ASCE). (Multiply feet by 0.3048 to obtain metres and inches by 25.4 to obtain millimetres)

the RCC dam at the north embankment. Cores and soundings were taken to locate sound rock and to provide an estimate as to how much overburden would have to be removed. The tests revealed a high water table in the proposed north abutment of the RCC dam. This water table supports the wetlands area adjacent to the proposed excavation area. TVA decided to use steel sheet-pile cells in this area instead of RCC. The steel sheet-pile cells were installed while the rest of the area was being excavated for placement of the RCC and an RCC mixture with deliberately entrained air was being proportioned for the project (Newell, Manson, and Wagner 1991).

Several trial mixtures were developed for the project (Cannon 1993). All mixtures were proportioned with the computer program CANMIX. Type I cement, Class F fly ash, and crushed limestone were used for all mixtures. Maximum size aggregate for mixtures 1 through 4 was 25 mm (1 in.) (Figure 42). Specified air content was 5 percent. To achieve this percentage with the selected materials, three to four times the normal amount of air-entraining admixture (AEA) was required. The original specification for average compressive strength was 25.5 MPa (3,700 psi) at 90 days. Compressive strength and splitting tensile strength tests for mixtures 1 through 4 were performed at 7, 28, and 90 days (Figure 43). After the compressive strength tests were performed at 28 days, a decision was made to adjust the mixture proportions to lower the 90-day strength to 20.7 MPa (3,000 psi). This reduced compressive strength, with the 5 percent air entrainment, was considered adequate for the exposed downstream face. Also, reducing the compressive strength reduced the heat generating characteristics of the concrete by about 25 percent. Mixtures 5 and 6 include these changes, plus they have higher coarse aggregate content because of concern that the basic mixtures would be too workable to be compacted with a vibrating roller. No strength tests were performed on these mixtures.

Complete dewatering of the construction site was never achieved. Workers were never able to stop the leakage from under and around the cofferdam. The amount of leakage was significant enough that only limited areas of the foundation could be prepared at a time. This problem limited the extent of RCC placement such that the normal placement of lifts from abutment to abutment could not be done. Instead, the RCC had to be placed in steps from the lower to the upper end as the foundation was excavated and cleaned (Cannon 1993).

RCC placement began in July 1990 and was limited to four 10-hr shifts per week. Mean ambient temperatures generally ranged from 27 to 32 deg C (80 to 90 deg F) during the first 3 months of placement. The batch plant was approximately 19 km (12 miles) from the project site. Delivery trucks required a minimum of 30 min to load and unload 9.2 cu m (12 cu yd) of RCC. These conditions made it very difficult for the contractor to maintain concrete temperatures below the specified 30-deg C (85-deg F) limit. The combined effect of high temperatures and extended time lapse between mixing and placing caused a definite loss in the consistency of the mixture. The initial target consistency for the placement site was a measured vibration time of 25 sec in a 0.007-cu-m (1/4-cu-ft) container without a surcharge. The loss in consistency, from batch plant to project site, required that the target consistency be revised to 10-sec vibration time at the



Mix	Cement (lb)	Fly ash (lb)	Water (lb)	Aggregates		AEA (oz)	Unit Weight (pcf)	Air (%)	Vibration Time (sec)
				Coarse (lb)	Fine (lb)				
Control	17.1	22.9	18.9	149.5	241.0	0.0	153.8	2.3	31
#2	17.1	22.9	18.9	149.5	241.0	0.67	152.5	3.2	37
#3	17.1	22.9	19.9	149.5	241.0	1.33	150.8	3.9	18
#4	17.1	22.9	19.9	149.5	241.0	2.0	142.8	9.0	7
#5	14.6	22.9	18.6	139.3	248.0	1.6	152.1	3.3	30
#6	14.2	23.0	19.1	135.0	255.0	1.6	151.3	3.7	24

Figure 42. RCC trial mixture proportioned for Nickajack Dam (courtesy of Cannon 1993)

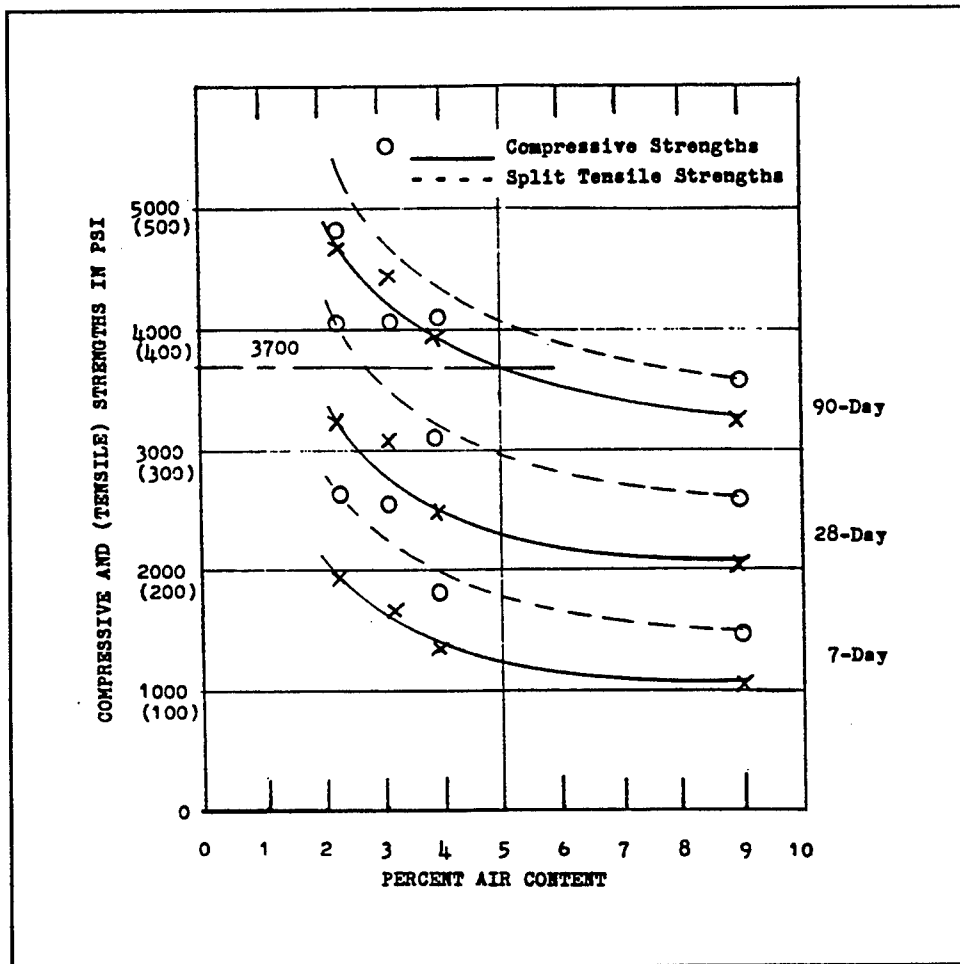

Figure 43. Results of strength tests on RCC mixtures, Nickajack Dam (courtesy of Cannon 1993). (Multiply psi by 0.006894757 to obtain MPa)

batch plant during the hot weather. With this change, the workability of the RCC was adequate when it first reached the job site, but it decreased rapidly enough to affect the blending of batch plant during the loads and the plasticity of layers. Doubling the dosage of water-reducing admixture (WRA) for batches with normal water content resulted in concrete too wet for proper placement. However, when the consistency was reduced back to 10 to 15 sec by reducing the water content, there was no improvement in the loss of workability with time at the project site.

Mixtures were then proportioned for 8-to 10-sec vibration time without WRA and with and without air entrainment. Mixtures with an air content of 5 percent required approximately 4.5 kg (10 lb) of additional water without the WRA, whereas the nonair-entrained mixtures required approximately 9.1 kg (20 lb) more water. In each case, there was a marked improvement in both the wetness of the concrete on arrival at the project and when placed. The air-entrained mixture No. 5 (Figure 44) without WRA was then used for the remainder of the project.

Mix		No. Tests	Cement (lb)	Fly ash (lb)	Water (lb)	Aggregates		Compressive Strength		
No.	Type					Coarse (lb)	Fine (lb)	7-day (psi)	28-day (psi)	90-day (psi)
3	RCC	22	134	186	180	1,224	2,300	1,198	2,455	3,848
5	RCC	67	143	200	190	1,245	2,320	1,078	2,000	3,254
8	FACE	15	160	215	208	1,375	2,015	1,021	1,937	3,202

Figure 44. Principal RCC mixtures used at Nickajack Dam (courtesy of Cannon 1993). (Multiply pounds by 0.4535924 to obtain kilograms and psi by 0.006894757 to obtain MPa)

Controlling the air content in the RCC mixtures presented no unusual problems. Air contents did appear to be somewhat easier to control when a WRA was not used. The dosage of AEA generally ranged from 0.54 to 0.62 l/cu m (14 to 16 oz per cu yd). Air contents averaged 4.1 and 4.6 percent for mixtures with and without WRA, respectively.

Tensile bonding of the lifts was not considered in the design of the structure; therefore bedding mixtures were used only to cover the foundation rock. Following dumping, the RCC was spread in 0.31-m (1-ft) lifts with a dozer and compacted with a single-drum vibratory roller (Figure 45). The downstream and upstream faces of the dam were formed with 0.6- and 1.2-m- (2- and 4-ft-) high jump forms (Figures 46 and 47). Because of the inefficiency of the smaller compaction equipment used next to the forms, the project manager opted to use conventional concrete along the formed faces. The face concrete mixture (No. 8) was proportioned for a maximum slump of 25 mm (1 in.). Except for being consolidated internally, it was placed in essentially the same manner as the RCC. The results of this change was an improvement in the texture of the surface of the faces (Cannon 1993). The RCC was covered with a tarp for curing (Figure 48).



Figure 45. Spreading and compaction of RCC at Nickajack Dam



Figure 46. Typical form for downstream face at Nickajack Dam

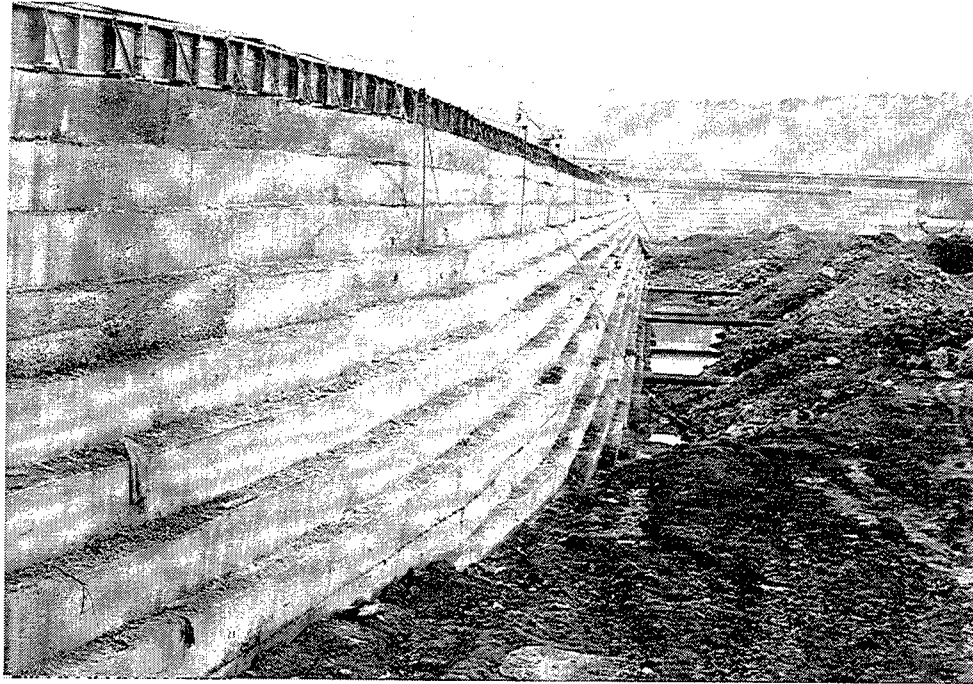

**Figure 47. Downstream face of RCC section, Nickajack Dam**

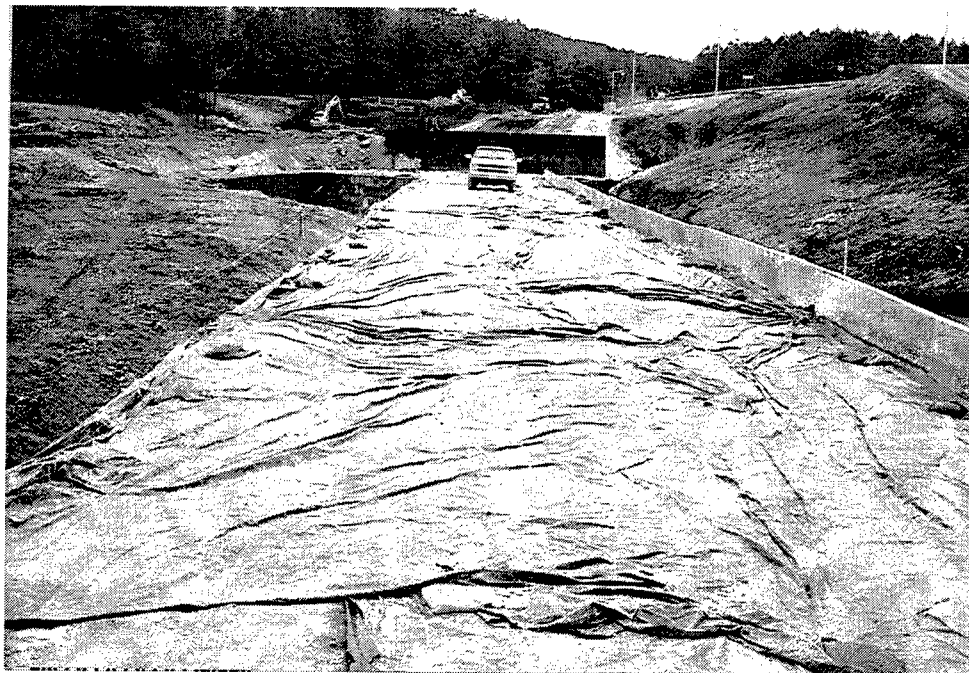

**Figure 48. Tarp used for curing RCC at Nickajack Dam**

Approximately 76,460 cu m (100,000 cu yd) of RCC was placed in 114 days between July 10, 1990, and February 13, 1991.

About 15 months after construction was begun, two 152-mm (6-in.) cores were extracted for testing. The cores, which were drilled through the full height of the structure, were taken from near the lock wall where construction began and about midway of the structure. The cores were extracted with a double-core barrel with a nominal pull length of 1.3 m (4.4 ft). Generally, one or two separations were found within each pull length of core, usually at an unbonded cold joint. A total of 78 cold joints were identified in the 32 m (105 ft) of core. Of these 22 were bonded and 56 were unbonded. The number of unbonded joints was not surprising because each day's placement was exposed for a minimum of 24 hr and no special treatment was used to cause the joints to bond.

All test specimens were soaked for 48 hr before tests for compressive strength, splitting tensile strength, and direct tensile strength were performed. Test specimens were selected from the entire 32 m (105 ft) of core to provide a representative average. The average compressive strength for 15 core specimens was 26 MPa (3,770 psi), which correlates well with the 90-day results of tests on cylinders shown in Figure 44. The average splitting tensile strength for eight core specimens was 2.7 MPa (390 psi) which also correlates well with 90-day results of tests on cylinders from trial mixtures with comparable air contents (Figure 43).

Direct tensile strength tests were performed on six specimens known to contain a lift joint or a cold joint. Direct tensile strengths of the bonded joints ranged from 0.5 to 1.7 MPa (78 to 241 psi). Three test results were below 0.7 MPa (100 psi) and three results were at or above 1.4 MPa (200 psi). The high and low tensile strengths were believed to represent lift joints and bonded cold joints, respectively (Cannon 1993).

Unit weights were determined for the 30 strength test specimens after they had been soaked for 48 hours. The average unit weight for specimens below el 183 m (600 ft) (mixture No. 3) was 2,456 kg/cu m (153.31 pcf); for those above, where mixture No. 5 was used, 2,439 kg/cu m (152.26 pcf). Calculations based on the theoretical air-free unit weights of the two mixtures indicate the air contents of the cores for mixtures 3 and 5 were 2.22 and 2.6 percent, respectively. These figures represent an apparent 2 percent loss in air content during transportation and placement of the RCC. This loss helps explain the loss in workability of the RCC from the batch plant to the project site, especially for mixtures with reduced water content.

The top of the dam, the downstream face, and the upper 0.3 m (10 ft) of the upstream face were inspected about 7 months after the last RCC placement. There were no full section cracks within the structure. Most of the cracks were of the hair-line type that were difficult to follow. Crack spacing appeared to be related more to the 0.6-m (2-ft) lift placements and exposure to cold weather on the downstream face rather than the cooling of the mass from hydration temperatures. Most of the cracks were no longer than the length of three lifts; however, the longest crack, which was near the center, did extend the length of

six lifts. The minimal cracking in the structure was attributed to the combined effects of the intermittent placing sequence, the longer than normal exposure of lifts, the relatively high tensile strength of the concrete, the relatively low heat generating properties of the concrete, and a rather mild winter (Cannon 1993).

As a result of this work, Cannon (1993) concluded that air entrainment in RCC appears to be limited to workable mixtures that can be consolidated under vibration within 30 sec without application of a surcharge weight; controlling the air content of workable RCC is no more difficult than controlling it in conventional concrete; depending on the concrete mixture and the air-entraining agent, RCC mixtures may require from two to four times the dosage of AEA normally used in conventional concrete to achieve a given air content; RCC mixtures with less stiffness than previously thought can support placing and compaction equipment (mixtures that will consolidate within an 8- to 10-sec vibration time without a surcharge weight can be used); and there will be some loss of air in RCC during transportation, spreading, and compaction with a large vibratory roller.

### **Ringtown No. 5 Dam**

Ringtown No. 5 Dam, located northeast of Harrisburg, PA, was constructed in the early 1900's. The 18.3-m- (60-ft-) high, 213.4-m- (700-ft-) long earth-fill dam had a concrete spillway structure that consisted of a broadcrested weir and a chute spillway. The dam was one of the primary sources of water in the supply system owned by Municipal Authority of the Borough of Shenandoah.

When the dam was inspected as part of the U.S. Army Corps of Engineers' Phase I Inspection Program, it received a high hazard rating because of inadequate spillway capacity. Because of the extent of deterioration of the spillway walls and slab, it was believed that discharges greater than 46 percent of the spillway design flood would result in overtopping and possible failure of the dam. In 1985, the owners commissioned an additional engineering study to help them determine present and future water supply needs and decide whether to breach or modify several of the dams in their supply system. The recommendation based on the study was to modify Ringtown No. 5 Dam. This case history is a summary of a report of the project by Johnson and Saber (1991).

Modifications included increasing spillway capacity, providing for dissipation of energy from spillway flows, flattening the downstream slope to improve embankment stability, constructing facilities to collect seepage, and modifying the outlet works to provide a positive means of upstream closure. During preliminary planning, both conventional concrete and RCC were considered as materials for modifications to the spillway.

The conventional concrete alternative was a 97.5-m- (320-ft-) long combined principal and emergency spillway structure with stilling basin located at the right abutment of the embankment. Because of site constraints, construction of the conventional concrete spillway would have required that the normal operating

level of the reservoir be lowered by 0.9 m (3 ft), about 15 percent of the available reservoir storage capacity. Construction of the conventional concrete spillway was estimated to cost a minimum of \$700,000.

The RCC alternative consisted of a 76.8-m- (252-ft-) long, trapezoidal-shaped spillway and stilling basin. The RCC alternative did not require a reduction in the normal operating level of the reservoir because of its wide crest geometry which was attained by constructing the spillway on the embankment. Based on the low bid for the project, the cost of the RCC spillway was about \$500,000 or approximately 40 percent of the total construction cost. The low bid for the RCC, which included furnishing the aggregate, cement, and pozzolan and batching and conveying, was approximately \$291,000 or \$60/cu m (\$46/cu yd). The RCC alternative (Figure 49) was selected because it would not affect reservoir capacity, it was more economical, and the stepped profile would aid in energy dissipation.

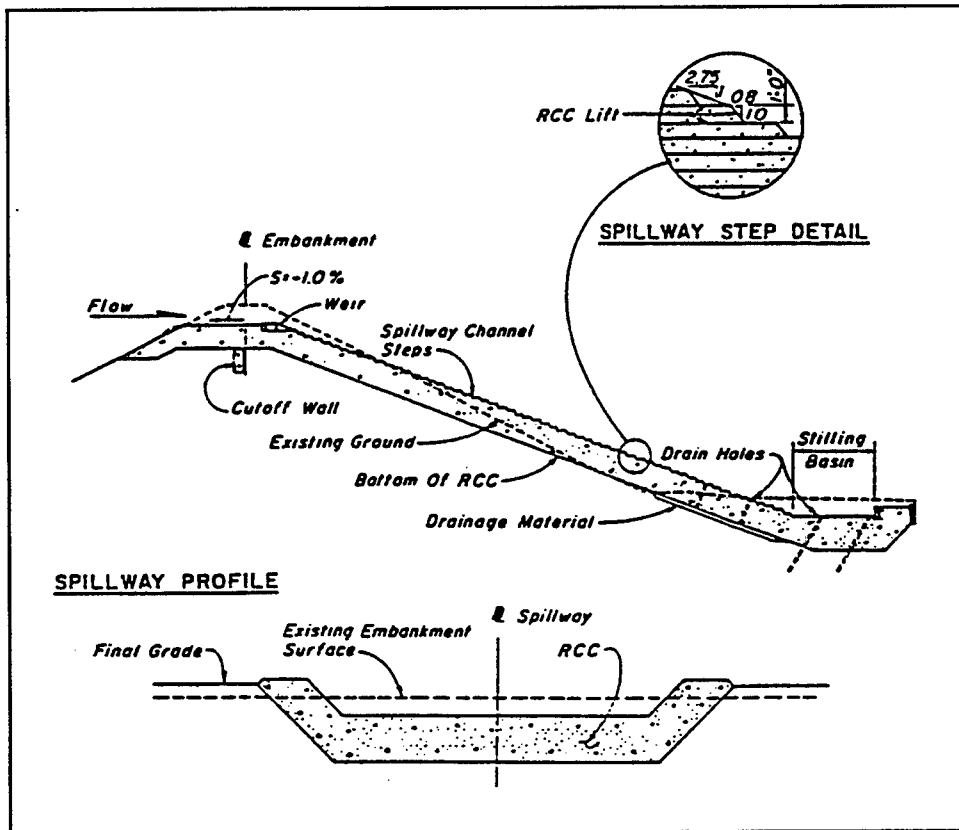

Figure 49. Spillway profile and section, Ringtown No. 5 Dam

Prior to placing the RCC, a portion of the embankment's downstream slope had to be flattened. The most economical plan was to place new earthfill across the entire downstream embankment surface to the 2.75H:1V slope and then to excavate the foundation for the new spillway structure.

RCC used in the project was proportioned to attain a compressive strength of 20.7 MPa (3,000 psi) at 90 days. Commercially available concrete aggregates

were used in the mixture. Class F fly ash was added to increase the paste volume, to improve workability, and to minimize heat of hydration. Mixture proportions for the RCC were as follows:

Material	Weight, kg/cu m (lb/cu yd)
Portland cement	135.3 (228)
Class F fly ash	103.2 (174)
Fine aggregate	802.7 (1,353)
Coarse aggregate	1,307.0 (2,203)
Water	113.9 (192)

RCC was mixed in a continuous mixing plant. When the lift surface was near the batch plant, RCC was discharged directly from the plant to the conveyor to the lift surface. When the lift surface moved farther from the plant, the material was transported to the conveyor by wheeled and tracked loaders. Once discharged onto the surface, the material was spread by a tracked loader and then roller compacted with a 9,070-kg (10-ton), self-propelled, smooth drum vibratory roller. A smaller dual-drum vibratory roller was used on small work surfaces; it achieved the specified densities with no problems.

At times drop heights were greater than 3 m (10 ft) from the transport belt to the lift surface, resulting in large stockpiles of batched material on the lift surface. Attempts were made to minimize drop height and size of stockpiles to prevent segregation. The loader operator corrected segregation in the stockpile by mixing the stockpile material before it was spread onto the lift.

Cold joints were treated according to the time lapse between successive lifts. If more than 800 deg-hr, but fewer than 24 hr, elapsed between lifts, a 25-mm (1-in.) thickness of conventional concrete bedding mixture was spread over the entire lift surface before the next layer of RCC was placed. If more than 24 hr elapsed between successive lifts, the cold joints were cleaned with air jetting or water jetting before the bedding mixture was placed.

The unformed channel steps and walls were constructed by stacking and offsetting 0.3-m- (1-ft-) thick horizontal lifts of RCC. A typical lift consisted of a 7.3-m- (24-ft-) long "main" portion and a 6.7-m- (22-ft-) long "wing" portion. Each lift was offset by 0.84 m (2.75 ft) horizontally in an upstream direction from the preceding lift. This method allowed the "wing" portion of a higher elevation to form the side walls for the channel portions of the lower elevation (Figure 50). As elevation increased, the width of the lifts increased.

The thickness of the RCC channel slab was determined by an analysis of the uplift forces which might act upon it during design flood conditions. The sliding stability of the RCC structure on the embankment would be greatly impacted by uplift forces generated by the embankment's piezometric surface and underseepage at the spillway and embankment interface. To reduce uplift forces,



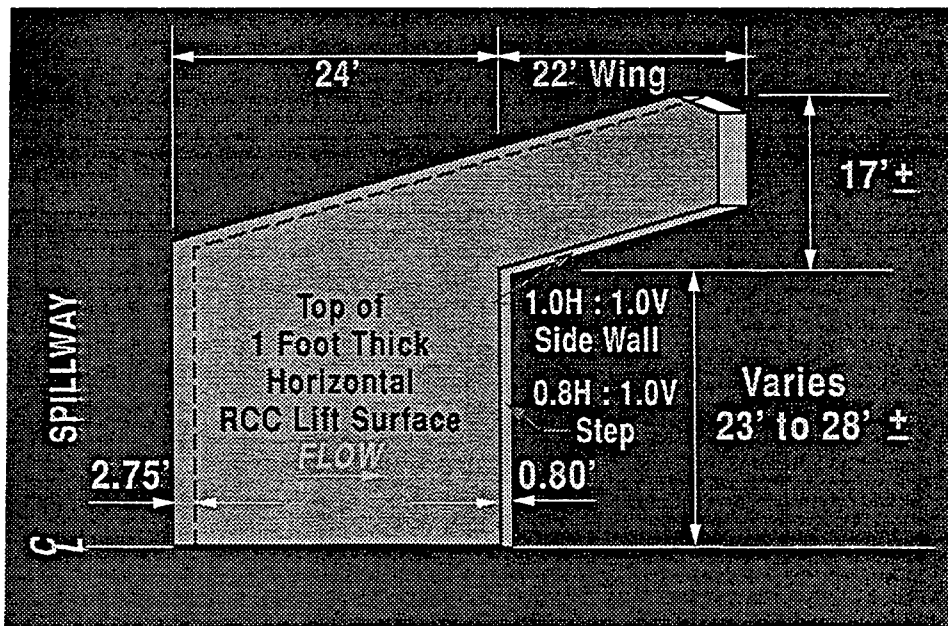

Figure 50. Typical lift plan, Ringtown No. 5 Dam (courtesy of Johnson and Saber 1991, ASDSO). (Multiply feet by 0.3048 to obtain metres)

a 2.1-m- (7-ft-) deep conventional concrete cutoff wall was constructed at the top of the dam below the spillway control section to prevent seepage from the reservoir along the embankment-RCC contact surface, and a spillway drainage system was installed. The drainage system consisted of trench drains, a blanket drain, and drain holes drilled through the RCC spillway slab. Seven vibrating wire piezometers were installed below the spillway structure to monitor uplift pressures.

The RCC for the steps was overplaced and compacted approximately 0.3 m (1 ft) beyond the proposed step location. The excess material was trimmed to the required 0.8H:0.1V slope (Figures 51 and 52). The trimmed material was mixed into the succeeding lift. The walls were trimmed to a final slope of 1H:1V.

The RCC was moist cured. Each layer was kept damp and at 1.7 deg C (35 deg F) until covered by the next layer. The final exposed surface was moist cured for 28 days or until it was covered with conventional concrete.

Conventional air-entrained, reinforced concrete was used for construction of the weir and the sill and end wall of the stilling basin control structure to protect the RCC at these locations from erosive forces during spillway overflows. Before the conventional concrete was placed, the RCC was saw cut to a depth of approximately 152 mm (6 in.) below the channel surface and then chipped and removed to a minimum depth of 0.3 m (1 ft) below the channel surface. To anchor the conventional concrete, reinforcing bars were embedded in the RCC, and then the lift was compacted around the bars.

Specifications called for the RCC to be placed during September 1990 when the climate would be favorable for placement and curing. However, because of

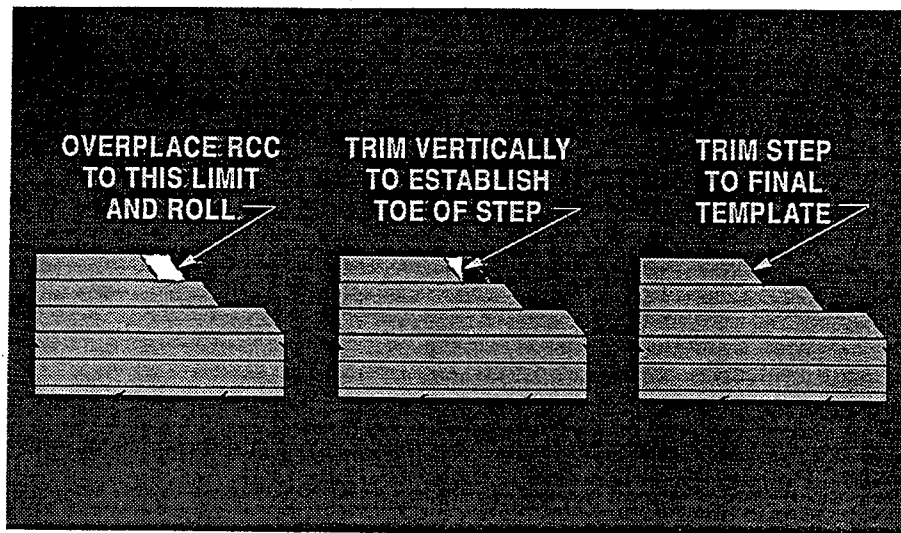

Figure 51. Sequence for step construction, Ringtown No. 5 Dam (courtesy of Johnson and Saber 1991, ASDSO)



Figure 52. Completed steps and wall, Ringtown No. 5 Dam

construction delays, placement began November 5 and lasted until December 13. Approximately 4,800 cu yd (6,300 cu m) of RCC was placed in 28 working days. The 28-day curing period ended January 10, 1991. Cooler temperatures during this period provided some advantages. Lower temperatures allowed for longer times between placement of RCC lifts; therefore, there were fewer cold joints. Also, the RCC was colder during placement, thus minimizing adiabatic temperature rise and eliminating thermal cracking of the RCC. There were no real problems caused by the cooler temperatures: RCC placement was not affected, but the RCC had to be protected from cold weather, so the work day started later, and there was some temporary freezing of the aggregate stockpile.

Quality control consisted of visual inspection and density and strength testing of RCC cylinders. Visual observations were made to check moisture content of the material as it was conveyed from the batch plant. The densities of cylinders cast for testing were compared with those measured with a nuclear density gage, and very good agreement was obtained. Strength tests on the cylinders indicated an average compressive strength of 24.5 MPa (3,560 psi) at 90 days. The completed spillway is shown in Figure 53.



Figure 53. Completed spillway, Ringtown No. 5 Dam

### Santa Cruz Dam

Santa Cruz Dam is located on the Santa Cruz River about 19 km (12 miles) east of Espanola and 48 km (30 miles) northwest of Santa Fe, NM. The cyclopean concrete arch dam was completed in 1929. At the maximum section, the original dam was approximately 45.7 m (150 ft) high, 15.2 m (50 ft) wide at the base, and 2.5 m (8 ft) wide at the crest. The axis of the dam was curved in plan to a radius of 91.4 m (300 ft) with a crest about 152.4 m (500 ft) long. The downstream face was vertical from the base to a height of about 5.2 m (17 ft) and the remainder of the face sloped (0.35H:1.0V). A 15.2-m- (50-ft-) wide uncontrolled overflow spillway was located near the center of the structure. The outlet works consisted of a 1.1-m- (3.5-ft-) diam steel pipe controlled by two tandem 610-mm (24-in.) gate valves housed on the downstream face of the dam.

The dam is owned and operated by the Santa Cruz Irrigation District. It supplies irrigation water to about 2,200 farmers. When constructed, the dam had a storage capacity of about 5,550,700 cu m (4,500 acre-ft). Over time, approximately 1,604,000 cu m (1,300 acre-ft) were lost because of siltation. This

loss of water caused increasing water shortages and economic losses to farmers during dry years (Hendricks 1989).

In 1976, the Santa Cruz Irrigation District contracted with the U.S. Bureau of Reclamation (USBR) to evaluate the structural stability of the dam and to study the possibility of raising the dam to restore the original water storage capacity. The investigation revealed that in addition to the lost storage capacity, the dam had suffered extensive concrete deterioration on the upstream and downstream faces as a result of cycles of freezing and thawing. The entire downstream face exhibited general deterioration with localized areas of severe deterioration. While the deterioration was not extensive enough to require emergency repairs, USBR recommended that repair of the dam faces be included in any modification plan. Further, a study of available seismic data indicated that an MCE could result in partial failure of the dam and uncontrolled release of a major portion of the reservoir (Hendricks 1989).

The investigation also revealed that the spillway capacity was inadequate to pass even a 10-year flood without overtopping of the dam. In the event of the PMF, the dam would be overtopped for 31 hr by up to 5.5 m (18 ft) with a peak discharge of 538 cms (119,000 cfs) (Metcalf, Dolen, and Hendricks 1992). Such an event would likely cause severe damage to the abutments and possible failure of the dam. Consequently, the Santa Cruz Irrigation District contracted with USBR to design modifications which would allow the dam to withstand loadings imparted by the MCE and PMF. Also, USBR investigated raising the dam to restore reservoir capacity and designed a replacement for the existing outlet works.

An in-depth study for modification of the spillway revealed that designing a spillway capable of passing the PMF without some overtopping was not feasible. Therefore, USBR modification plan included a spillway capable of passing floods slightly greater than the 25-year flood and provided overtopping protection for the abutments in the event of the PMF. In addition, the modification plan included repairing areas damaged by cycles of freezing and thawing, adding strength to resist MCE loadings, and adding new outlet works (Metcalf, Dolen, and Hendricks 1992).

An RCC buttress at the downstream face of the dam (Figure 54) was designed to reinforce the entire dam from the foundation to within 6.1 m (20 ft) of the crest. Also, the buttress was designed to provide erosion protection to both abutments in the event of dam overtopping. A stepped-chute conventional concrete spillway was incorporated into the RCC buttress. The spillway chute converges from 22.9 m (75 ft) wide at the uncontrolled ogee crest to 16.2 m (53 ft) wide at the stilling basin 36.6 m (120 ft) below (Metcalf, Dolen, Hendricks 1992).

Strength requirements for the RCC mixture were based on MCE loading conditions. The RCC was proportioned to have a compressive strength of 20.7 MPa (3,000 psi) at 1 year, cohesion of 0.34 MPa (50 psi) at 1 year (new to old concrete), and freeze-thaw durability (minimum of 500 cycles). An AEA was

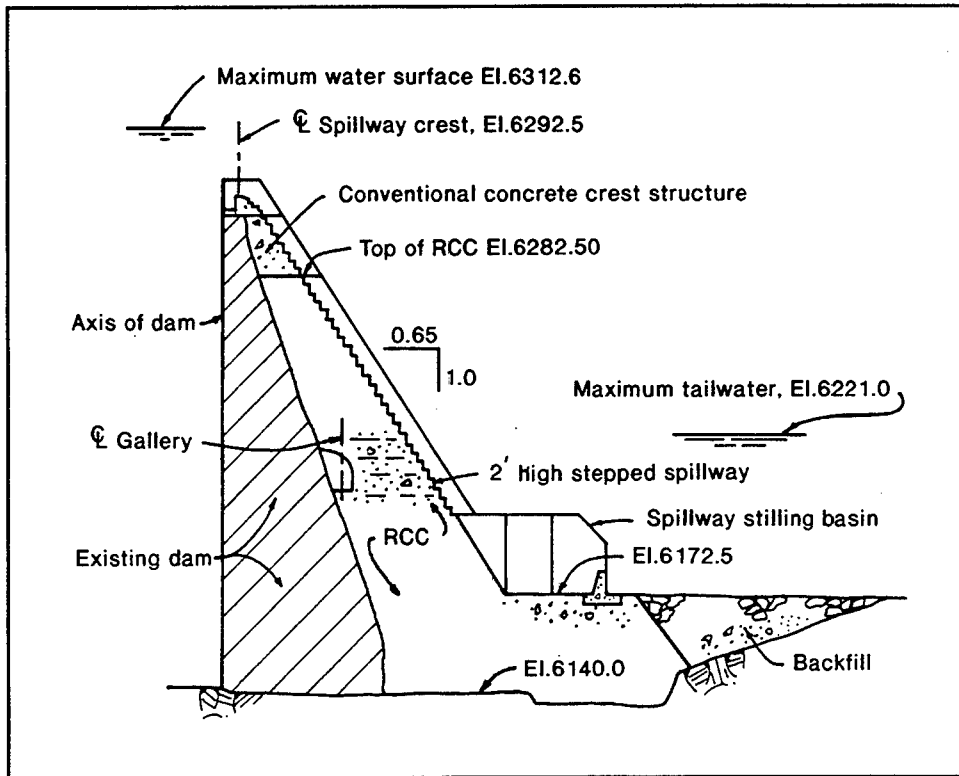

Figure 54. Section showing original Santa Cruz Dam and modifications (courtesy of Metcalf, Dolen, and Hendricks 1992, ASCE)

added to the RCC to increase its resistance to freezing and thawing (Metcalf, Dolen, and Hendricks 1992).

Early attempts to develop a suitable air-void system in lean, dry RCC mixtures were unsuccessful and the freeze-thaw durability of RCC was considered poor. Typically, structures were designed so that the RCC was protected from cycles of freezing and thawing or sacrificial RCC was provided to allow for deterioration. However, favorable results in preliminary tests on air-entrained RCC prompted USBR to conduct a comparative study as part of the RCC mixture proportioning investigations for the Santa Cruz Dam modification (Dolen 1991). When tested at 90-days age, RCC mixtures without an AEA failed at an average of 66 cycles, with failure defined as a 25 percent loss in specimen mass. RCC mixtures with an AEA experienced failure at an average of 419 cycles of freezing and thawing. Although this average did not meet USBR criteria, the addition of an AEA improved freeze-thaw durability more than 450 percent over that of RCC without an AEA. Also, the use of an AEA resulted in a mixture with improved workability and reduced water requirement. The compressive strengths of the mixtures were similar for given cementitious contents.

The contractor elected to use natural stream-worn sands and gravels from a producer about 19 km (12 miles) from the dam. Only three size fractions were required: sand conforming to ASTM C 33 (1975a) grading, No. 4 to 25-mm

(1-in.) aggregate, and 25- to 51-mm (1- to 2-in.) aggregate. The primarily granitic natural aggregates were supplemented with crushed material. Cement conformed to ASTM C 150 (1975c) for Type II low alkali cement. The pozzolan was a fly ash that conformed to ASTM C 618 (1975d) for Class F pozzolan. The air-entraining admixture was a vinsol resin; double the normally specified rate was used.

Mixture proportioning studies were conducted during the design phase and again before construction because of a change in the aggregate source. Based on these tests the cementitious content of the RCC mixture was increased from 132.9 to 151.3 kg/cu m (224 to 255 lb/cu yd) to begin construction. This increase was necessary to ensure that the results of 80 percent of all compressive strength tests exceeded the design strength. Average RCC mixture proportions were as follows:

Material	Weight, <sup>1</sup> kg/cu m (lb/cu yd)	Weight, <sup>2</sup> kg/cu m (lb/cu yd)
Portland cement, Type II	75.9 (128)	80.1 (135)
Class F fly ash	75.3 (127)	80.1 (135)
Fine aggregate	728.0 (1,227)	828.2 (1,396)
Coarse aggregate	1,365.2 (2,301)	1,253.6 (2,113)
Water	100.9 (170)	100.9 (170)

<sup>1</sup> Dec 1989 and Jan 1990

<sup>2</sup> Mar 1990

Preparatory work prior to construction of the buttress included constructing a small cofferdam, installing a diversion pipe, draining the reservoir, removing the deteriorated concrete below the dam crest and the spillway crest, hydraulically scaling the 4,010-sq-m (4,800-sq-yd) downstream face of the dam, removing the wet well on the upstream face, and excavating 38,200 cu m (50,000 cu yd) of foundation rock. The specifications required that the RCC be placed in two separate 3-week phases with continuous placement around the clock. The Phase I RCC placement (foundation to gallery) was planned for early November 1989; however, flooding delayed placement until late December.

RCC was batched and mixed in a 362,900-kg (400-ton-) per-hr pugmill and transported to the dam by a 115.8-m (380-ft) conveyor-belt system. At the dam, it passed through a rotating swinger which either placed the RCC directly or deposited it into a surge pile from which it would be taken to the final location by front-end loaders. A bulldozer with a blade-mounted, laser-guided leveling device was used to grade the RCC into 457-mm (18-in.) lifts. The RCC was compacted with a vibrating roller in one static and six dynamic passes. Densities were measured with a single probe nuclear density gauge.

Some adjustments had to be made in mixing and handling the RCC because of the colder ambient temperatures resulting from the delay in starting placement. An RCC placement temperature of 7.3 to 12.9 deg C (45 to 55 deg F) was

required; however, the average daily temperature in December was 4 deg C (39 deg F), and nighttime temperatures were well below freezing. Using mixing water heated to 94 deg C (200 deg F) produced concrete temperatures within the specified guidelines, but the RCC mixture typically lost 5 deg in transit, and surge pile temperatures frequently measured close to 7.3 deg C (45 deg F), the lower end of the acceptable range. Placing, grading, and compacting often caused additional loss of heat. On a few occasions when the ambient temperature fell below -7 deg C (20 deg F), ice crystals formed on the large aggregate in the newly placed RCC. In these cases, production was halted, and the RCC was covered with plastic and overlaid with thermal blankets. The blankets helped to retain the heat generated by the hydrating cement and kept the RCC consistently around 7.3 deg C (45 deg F). The low ambient temperature slowed the hydration process so that the next morning the RCC lift surface was sufficiently green to bond with a new layer (Metcalf, Dolen, Hendricks 1992).

For each lift, an interface zone of leveling concrete — 27.6 MPa (4,000 psi) compressive strength — was placed at the contact between the existing dam face, abutments, and the RCC lift to bond the RCC to the existing dam surfaces. Immersion vibrators were used to consolidate the leveling concrete and then were placed into the contact zone to fuse the two mixtures. The top surface was consolidated with plate vibrators. Both the RCC and conventional concrete were batched onsite for the first reach of RCC; however, having to switch the single batch plant between production of the two concretes created problems with the equipment and the batch plant computer. The result was loss of time and material. The Phase I RCC placement was completed 16 January 1990.

The Phase II RCC placement began on March 7. To ensure bond between the existing RCC surface and the new RCC lift, workers scoured the existing surface with a water jet and then covered the surface with a layer of grout. Ironically, the higher ambient temperatures during this time were almost too warm for placement of the RCC, so placement was scheduled for the cooler part of the day. Leveling and facing concrete for this section were produced offsite and trucked in. Near the top, the work area narrowed to about 4.6 m (15 ft), the width required for the placing equipment. This limited work space necessitated careful coordination of personnel and equipment.

The contractor used 0.6- by 1.2-m (2- by 4-ft) forms to construct 1.2-m (4-ft) chords for the stair-stepped spillway face. First, the RCC was placed and compacted with a plate vibrator. Then conventional concrete was placed between the forms and RCC, and leveling concrete between the abutments and RCC. The placing rate was normally 1.2 m (4 ft) per day; the setting time of the facing concrete and RCC did not seem to interfere with the rate of construction. The Phase II RCC placement was completed on March 25. Overall, the project required approximately 29,400 cu m (38,500 cu yd) of RCC. The bid price for the RCC was \$59.83/cu m (\$45.74/cu yd) (*RCC Newsletter* 1989). The modified structure is shown in Figure 55.

During batching and placing, RCC quality control activities consisted of monitoring the RCC plant to ensure a continuous flow of aggregates and

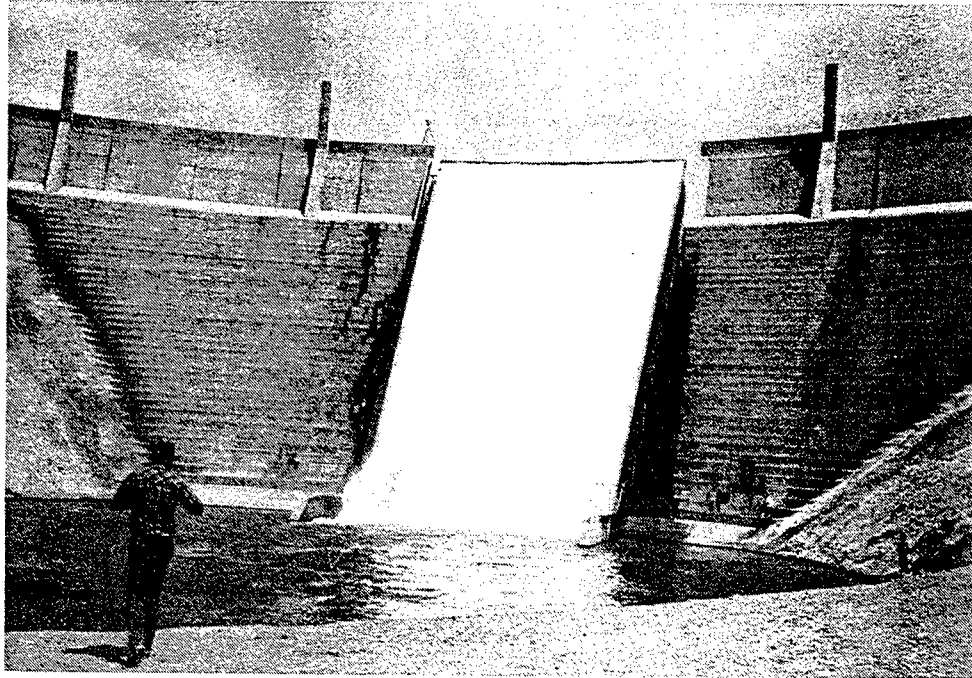

Figure 55. Downstream face of Santa Cruz Dam after modifications (courtesy of Metcalf, Dolen, and Hendricks 1992, ASCE)

cementitious materials, sampling aggregates for moisture and grading, performing tests on fresh and hardened concrete, and checking density, and moisture content. Average properties of the fresh and hardened RCC were as follows:

Time	Results
Temperature	31.1 deg C (56 deg F)
Vebe time, sec	19
Air content, percent	
Pressure	2.3
Gravimetric	3.3
Density	
Vebe	2,361.1 kg/cu m (147.4/lb cu ft)
Nuclear	2,380.3 kg/cu m (148.6/lb cu ft)
Compressive strength, MPa (psi)	
7 days	7.5 (1,090)
28 days	18.8 (2,730)
90 days	22.2 (3,220)
365 days	30.5 (4,420)

Vebe tests were conducted in accordance with a proposed ASTM standard for consistency and density of concrete by vibrating table. A 22.7-kg (50-lb) surcharge was used. Vebe times ranged from 7 to 25 sec with an average of about 19 sec. Pressure air contents were determined by vibrating a sample of concrete in a 0.007-cu-m (0.25-cu-ft) container on the Vebe table and conducting



the test according to ASTM procedures. Specimens for hardened control tests were cast on a vibrating table.

A single-probe nuclear density gauge placed at a 305-mm (12-in.) depth was used to monitor moisture and density. The average maximum density (AMD) was used to determine density requirements. RCC with suitable moisture for a Vebe time of 15 sec was placed in a control section and then compacted to its maximum wet density by repeated passes with the vibrating roller. The average obtained from 10 density tests was used as the AMD value. Specifications required the contractor to place the RCC at an average of 99 percent of the AMD. The AMD control section was repeated after every 3,820 cu m (5,000 cu yd) of RCC was placed, when the workability changed substantially, or when batch quantities of constituents were changed, particularly water content.

Cores were taken from the dam during construction for a limited number of strength and freeze-thaw durability tests and for petrographic examination. The RCC averaged 335 cycles in freeze-thaw durability testing which did not meet USBR criteria. One of the causes of the freeze-thaw failures was popouts of coarse aggregate from the cores rather than deterioration of the paste. This occurrence is more common with cores than with cast cylinders and is aggravated by smooth faces of coarse aggregate (Metcalf, Dolen, and Hendricks 1992).

### **Thompson Park Dam No. 3**

Thompson Park Dam No. 3 is a small earth dam located in an urban area in Amarillo, TX. When an inspection revealed deterioration of the drop spillway, an investigation into rehabilitation alternatives was begun.

A general assumption is that any dam that has residential or commercial development downstream of it must be able to safely pass the PMF without overtopping. HDR Engineering, Inc., uses a different approach: it investigates the impact of a potential breach on the downstream reach. Their impact analysis is based on a critical flood instead of the PMF because, comparatively speaking, the amount of damage caused by flows greater than the critical flood declines to an insignificant level. Significance is determined by comparing calculated flow at the breach peak and the nonbreach peak at a certain point downstream. If the flow is less than 0.3 m (1 ft), the impact is considered to be insignificant. An analysis of the Thompson Park Dam No. 3 reach determined that the critical flood was about 40 percent of the PMF.

Thompson Park Dam No. 3 was rehabilitated by replacement of the deteriorated drop spillway and installation of a roller-compacted-concrete armor section on the earth embankment as an auxiliary spillway. This rehabilitation alternative cost approximately 60 percent of the cost to rehabilitate the dam to pass the full PMF. The cost of the breach analysis was approximately 10 percent of the construction cost savings (Zovne 1989).

## Ashton Dam

The Ashton Hydroelectric Project is located on Henry's Fork of the Snake River near Ashton, ID. The Project consists of an earth- and rock-fill dam with a spillway and a powerhouse. The dam, which is located in the center of the river between the powerhouse and spillway, is 68.9 m (226 ft) long and 18.3 m (60 ft) high and has a 6.1-m- (20-ft-) wide crest. The 25-m- (82-ft-) wide, six-bay reinforced concrete spillway is located adjacent to the east abutment of the dam. The dam was constructed between 1910 and 1913. Riprap along the shoreline protects the upstream slope against wave action and during reservoir drawdown. The rock fill of the dam is the only protection on the downstream slope.

In the mid-1980s, the PMF flow was determined to be 1,305 cu m/sec (46,100 cfs) compared to the existing spillway capacity of only 343 cms (12,100 cfs). Therefore, the Federal Energy Regulatory Commission (FERC) required PacifiCorp, owners of the utility, to increase the dam's spillway capacity. Black & Veatch, consulting engineers for the project, evaluated several alternatives for passing the PMF flow. The investigation of alternatives for the project and the rehabilitation plan were reported by Froehlich and Nigus (1991); their report is summarized here.

Two approaches were considered for passing the PMF flow. One approach would pass the flow without raising the level of the reservoir above the existing dam crest, whereas the other approach would allow the pool level to rise above the crest. Six options including a wide variety of materials were evaluated for each approach. The most cost effective alternative was to protect the crest and downstream slope of the existing dam with RCC and allow the dam to be overtopped in the event of the PMF (Figure 56). FERC staff approved the design and allowed for a maximum overtopping height of 3.7 m (12 ft) in conjunction with a maximum unit discharge of 3.5 cms (122 cfs) per foot of spillway crest.

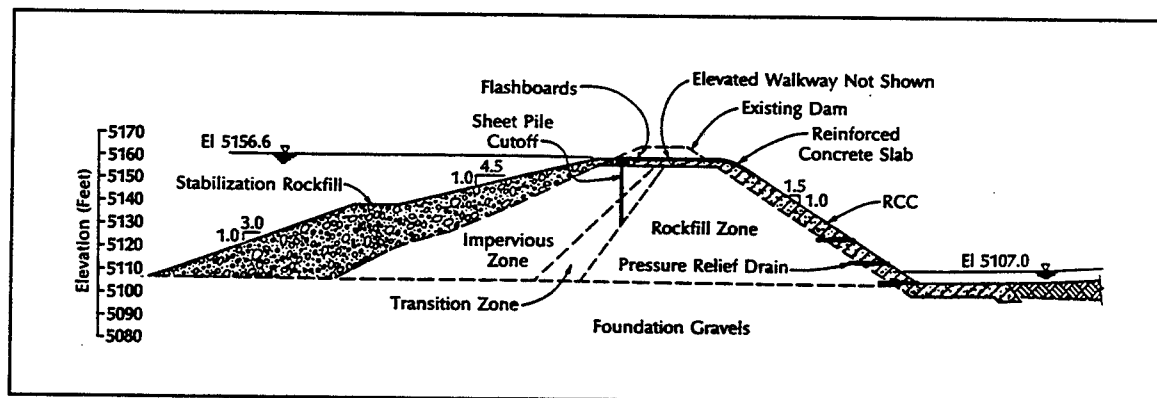

Figure 56. Cross section of Ashton Dam (courtesy of Froehlich and Nigus 1991, ASCE). (Multiply feet by 0.3048 to obtain metres)

The crest of the new dam overflow spillway is approximately 61 m (200 ft) long, extending from the west spillway training wall to the powerhouse. The RCC spillway crest, 1.5 m (5 ft) below the original crest of the existing dam, was

overlayed with a conventional reinforced concrete slab. Flashboards installed at the upstream side of the crest keep water at normal levels from overflowing the spillway. A cutoff wall extending from the crest to the dam's rock fill provides protection to the spillway crest in the case of upstream slope deformation because of an earthquake event.

The downstream slope of the overflow spillway is 1.5H:1V down to el 5,101 and then the RCC extends 12.2 m (40 ft) downstream to provide erosion protection to the area at the toe of the dam during a PMF. This flat stilling basin extension will provide energy dissipation and protect the dam from erosion caused by the adjacent powerhouse discharges. A 2.4-m- (8-ft) high training wall along the west edge of the spillway directs flow away from the powerhouse tailrace area (Figure 57). Pressure relief drains were embedded in the RCC at el 5,101, 5,110, and 5,120. The 152-mm- (6-in.-) diam PVC pipes spaced on 3-m (10-ft) centers allow the dam's seepage to flow through the RCC, thus reducing the uplift pressure on the RCC structure.

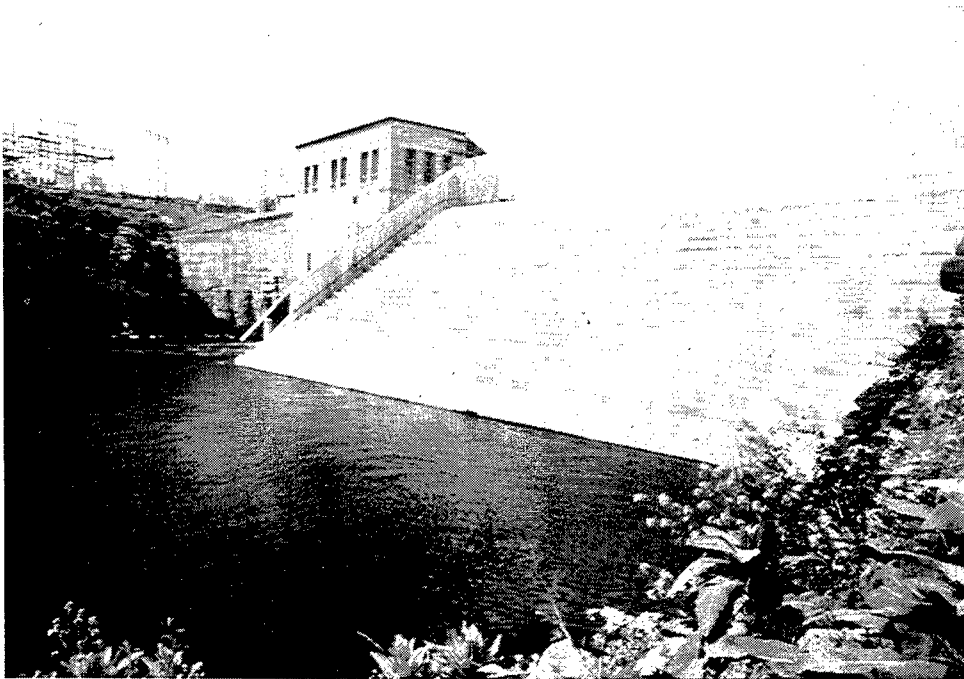

Figure 57. Completed overflow spillway, Ashton Dam

A minimum compressive strength of 17.2 MPa (2,500 psi) at 28 days was specified for the RCC. The RCC mixture contained 178 and 59 kg/cu m (300 and 100 lb/cu yd) of portland cement and Class F fly ash, respectively. The RCC was placed in a stepped profile on the downstream slope. The steps, which will help dissipate the energy of the overflow, are 0.3 m (1 ft) high and 0.5 m (1.5 ft) wide. Approximately 5,900 cu m (7,700 cu yd) of RCC were placed in 12 days. Modifications to the dam were completed during 1991.

## Lake Lenape Dam

Lake Lenape Dam, which was constructed during the latter half of the 19th century, is located on Great Egg Harbor River at Mays Landing, New Jersey. The earth embankment dam impounds an 8,153,000-cu-m (6,610-acre-ft) reservoir that is used for recreation. The dam is 320 m (1,050 ft) long and has a maximum height of 5.2 m (17 ft). The spillway, a 37.8 m (124-ft) stone masonry section, is located 67 m (220 ft) from the right abutment. Three 1,219 mm (48-in.-) diam low-level outlets are located through the base of the spillway. Two 610-mm- (24-in.-) diam turbine intake conduits and a 1.2-m- (4-ft-) wide sluiceway, part of a defunct hydroelectric facility built at the site in 1920, provide additional outlet capacity.

A 1988 report prepared by an engineering company hired to rehabilitate the dam cited a number of deficiencies at the dam (Ditchey 1992). The report was based on a review of the Corps of Engineers Phase I Report plus visual inspection, topographic survey, subsurface investigations, a laboratory testing program, and engineering analyses. The investigations revealed that embankments were overgrown with trees and brush and were eroded in some sections, the majority of the slopes did not meet minimum required slope stability, upstream riprap slope protection was inadequate, the crest elevation of some sections of the dam was at 4.7 m (15.5 ft) (design elevation was 5.2 m (17.0 ft)), the spillway did not meet minimum stability requirements, the spillway discharge capacity was only 25 percent of the PMF, and low-level outlet gates and operators were in varying stages of disrepair.

Methods for correcting some of the deficiencies were obvious, such as removing the trees and brush from the embankments, replacing the low-level gates and operators, and supplementing the upstream riprap; however, engineers had to determine the best, most cost-effective means for stabilizing the embankments and spillway and increasing spillway capacity. In addition to economic and technical considerations, the rehabilitation alternative selected had to be in keeping with the historic setting of the dam site and surrounding community and could not require a drawdown of the lake in excess of 152 mm (6 in.) because of fish spawning areas in the shallow reaches of the reservoir and summer recreational use of the reservoir.

The rehabilitation alternative selected was to armor the embankment sections to allow overtopping. Construction materials considered for the armoring included conventional concrete, rock-fill gabions, and RCC. Conventional concrete, which was estimated to cost between \$800,000 and \$900,000, was rejected because it would not have been in keeping with the historic surroundings. The rock-fill gabions, estimated at \$700,000, were rejected because of concern that corrosion and vandalism would limit their service life. RCC was the material of choice because of its relative economy and durability.

The rehabilitation plan specified placing the RCC in 0.3-m- (1-ft-) thick horizontal lifts with a stepped downstream slope of 2.5H:1V (Figure 58). Site restrictions prevented construction of an apron at the downstream toe to provide

protection against undermining during overtopping; the alternative was a sheet-pile wall. So the rehabilitated dam would harmonize with the surrounding area, plans included covering the RCC with topsoil and seeding it.

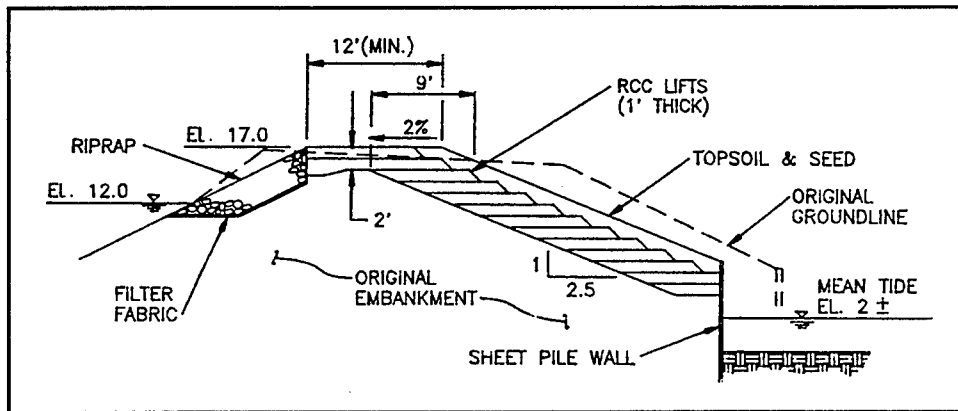

Figure 58. Rehabilitation plan for Lake Lenape Dam (courtesy of Ditchey 1992, ASCE). (Multiply feet by 0.3048 to obtain metres)

Since the engineering firm that was rehabilitating Lake Lenape Dam was also performing similar work in Pennsylvania, a single laboratory program was initiated to develop an RCC mixture appropriate for each project. The intent was to use readily available aggregates that met the standard specifications of both the New Jersey Department of Transportation (NJDOT) the Pennsylvania Department of Transportation (PADOT).

The maximum-density approach to proportioning RCC mixtures as presented in the *ACI Materials Journal* (1988) was used in developing initial mixture proportions. The design compressive strength was 20.7 kg (3,000 psi) at 28 days. Four laboratory trial proportions were established with varying cement content and aggregate type. The cement was Type II; coarse aggregate met the gradation requirements of AASHTO #57; fine aggregate met the NJDOT and PADOT requirements of a bituminous concrete sand. Also, a preblended aggregate mixture was used. The trial mixtures were mixed in a 3.8-cu-m (5-cu-yd) drum mixer. Six standard 152- by 305-mm (6- by 12-in.) test cylinders were prepared for each of the trial mixtures. Cylinders were prepared by screening out plus 38-mm (1-1/2-in.) material and compacting the RCC in three equal lifts. A pole tamper fitted with a 140-mm- (5.5-in.) diam butt plate was used for compaction. A pressure pot was used to measure actual air content for each mixture. Figure 59 shows the mixture proportions and the laboratory test results for the four mixtures.

Ditchey (1992) offers a number of general comments about the laboratory program that could have resulted in inconsistencies in the data. First, a drum mixer is different from a pug mill and can produce a very different mixture. The mixtures tended to stick to the side of the drum, causing the mixing to be interrupted while the mixture was scraped off. The cement used for mixtures 1 and 4 was lumpy; a new bag of cement with no apparent lumps was used for

<b>Table 1 RCC Mix Data</b>				
	<b>Mix</b>			
	<b>1</b>	<b>2</b>	<b>3</b>	<b>4</b>
Coarse Aggregate (pcf - SSD)	89.3	89.3	89.3	134.4
Fine Aggregate (pcf - SSD)	45.0	45.0	45.0	.*
Cement (pcf) - Type II	10.8	9.8	12.0	16.0
Free Water (pcf)	7.0	7.3	6.6	8.5
Unit Weight (pcf)	152.7	151.4	152.9	158.9
Theoretical Air Content (%)	2	2	2	2
W/C Ratio (by weight)	0.65	0.74	0.55	0.53
Actual Air Content (%)	2.6	3.1	2.4	3.9
Unit Weight of Air-Free Mortar (pcf)	82.8	83.2	NA	87.8
Total Moisture Content (%)	NA	NA	NA	6.2
Average Cylinder Density (pcf)	148.3	141.2	141.5	142.4
Standard Deviation (pcf)	2.14	2.58	2.47	2.23
Average Compression Strength (psi)				
7 day	1,890	1,770	1,830	1,000
14 day	2,525	2,325	2,450	1,250
28 day	3,100	1,865	2,315	1,395
Cement Factor (pcy)	292	265	324	432

Figure 59. RCC trail mixture proportions and test results, Lake Lenape Dam (courtesy of Ditchey 1992, ASCE)

mixtures 2 and 3. Collar extensions were not used in compacting the last lift of RCC in the cylinders or the air pot. Cylinder densities were based on calculations from measurements taken immediately after the cylinders were prepared. Since this procedure cannot account for voids/air pockets found around the perimeter of the cylinder, the reported densities might have been lower than the actual densities. Also, three different technicians performed the air content testing with the pressure pot. Mixture No. 1 was selected for armoring the embankments of the dams.

The rehabilitation project was bid in March 1991. The low bid for RCC, topsoil, and permanent turf establishment was \$286,000 compared to the engineer's estimate of \$367,000. The engineer's estimate for 2,680 cu m (3,500 cu yd) of RCC was \$130/cu m (\$100/cu yd). Unit bid prices from the

20 bidders ranged from \$59 to \$235/cu m (\$45 to \$180/cu yd) with average of \$111/cu m (\$85/cu yd). A unit price of \$92/cu m (\$70.00/cu yd) was quoted by the successful bidder.

The RCC was mixed in a portable continuous-mixture plant. The project required 2,330 cu m (3,050 cu yd) of RCC, which was placed in eight single-shift days during August 1991. A 4,540-kg (5-ton) double-drum vibratory roller was used to compact the RCC except in confined areas, which were compacted with a plate tamper. The contractor's quality control program consisted of checking gradations of each aggregate pile, the RCC aggregate mixture, and aggregate moisture contents. A nuclear density gage was used to monitor the density and moisture content on the lift surface. Average in-place density was 2,418.8 kg/cu m (151.9 pcf); average moisture content was 4.2 percent. Placement temperatures on the lift surface averaged 31 deg C (87 deg F).

Quality assurance consisted of fabricating and testing sets of standard 152- by 305-mm (6- by 12-in.) cylinders. Average compressive strengths were 11.2 MPa (1,620 psi) at 7 days, 15.1 MPa (2,190 psi) at 14 days, and 17 MPa (2,460 psi) at 28 days. Compressive strengths were lower than anticipated. The lower strengths were attributed to the fact that the sets of cylinders were fabricated by three different people, only one of whom had experience in making RCC cylinders; the cylinders were fabricated without a mold extension, which made compaction of the top lift difficult; and several cylinder sets remained at the construction site four to six days before being placed in the cure room.

### **Saltlick Dam**

Saltlick Dam, owned by the Greater Johnstown Water Authority, is located on Saltlick Run in Cambria County about 11 km (7 miles) upstream of Johnstown, PA. The dam was constructed between 1909 and 1913 as part of a water supply system for Johnstown and surrounding communities. The earthen embankment structure is 254.5 m (835 ft) long and 33.5 m (110 ft) high with a 6.1-m- (20-ft-) wide crest. The center of the dam consists of a concrete core wall founded on pressure grouted bedrock. The core wall is surrounded by sluiced silt and clay and is covered with compacted earth fill. Upstream and downstream embankments are 1V:3H slopes. The upstream embankment has a 15.2-m- (50-ft-) wide berm 21.6 m (71 ft) below the dam crest. The downstream embankment contains a system of stone drains near the toe and to the right of the original stream. This embankment has a sod cover.

The original spillway was located at the left abutment of the dam. It consisted of an uncontrolled, U-shaped concrete ogee weir that projected into the reservoir. The 42.7-m- (140-ft-) long weir crest was 2.4 m (8 ft) below the top of the dam. Spillway flow moved through a concrete channel along the left abutment of the dam and then cascaded down a steep channel cut out of bedrock. The intake tower, which is located in the reservoir, is made of reinforced concrete.

The dam withstood floods in 1936, 1972, 1975, and 1977 without serious structural damage. The maximum known flood occurred in 1977 and was estimated to have a maximum flow of 190 cms (6,700 cfs). During this flood, the earth embankment along the right concrete wall of the channel was eroded, and a small footbridge over the spillway was washed out. This damage was quickly repaired.

In June 1978, Saltlick Dam was judged to be unsafe nonemergency in the Phase I inspection of the National Dam Safety Program, and it was recommended that immediate studies be performed to determine the spillway capacity and the stability of the dam embankments. Subsequent studies were conducted by Gannett Fleming, Inc., in compliance with recommendations by the Commonwealth of Pennsylvania, Department of Environmental Resources (DER). It was concluded that (a) the existing spillway could handle only 37 percent of the PMF and that the spillway might be vulnerable to blockage from slides of potentially unstable material on the adjacent hillside, (b) the spillway and spillway channel needed repairs, (c) the stability of the downstream embankment was questionable, and (d) the blowoff equipment in the intake tower needed to be replaced. This case history is a summary of the project report by Bingham and Schweiger (1990).

In early 1983, several emergency repairs, including construction of rockfill toe berm and spillway repairs were made. Also, a search for an economical method of increasing spillway capacity was begun. A plan to construct a large-side channel emergency spillway with conventional concrete was rejected because costs were unacceptably high. Modification plans were suspended, and breaching the dam was considered when the owner became aware of the possibility of purchasing a nearby water system to replace Saltlick Dam. In 1988, DER notified the owner he would have to breach Saltlick Dam or modify it to meet current DER standards by 1991. Consequently, the owner requested that Gannett Fleming, Inc., conduct a study of the options available for modifying the dam. The options and estimated costs were (a) to construct a conventional concrete spillway (the 1983 plan), \$7,515,000; (b) construct two new RCC emergency spillways, \$4,880,000; (c) lower the height of the dam to 10.7 m (35 ft) and construct a combined principal and auxiliary spillway, \$4,700,000; and (d) breach the dam, \$2,920,000.

The RCC alternative was chosen as it was more cost-effective than the 1983 plan and only slightly more costly than lowering the dam, which would have reduced reservoir capacity. The rehabilitation project consisted of raising the top of the dam 0.9 m (3 ft), constructing emergency spillways with RCC at the left and right abutments of the dam, lowering and repairing the existing concrete spillway, replacing the blowoff facilities, raising the intake tower, and enlarging the toe berm (Figure 60).

Complex foundation conditions and unusual loadings created construction problems that required innovative design solutions. One of these problems involved finding a way to construct the emergency spillways with minimum



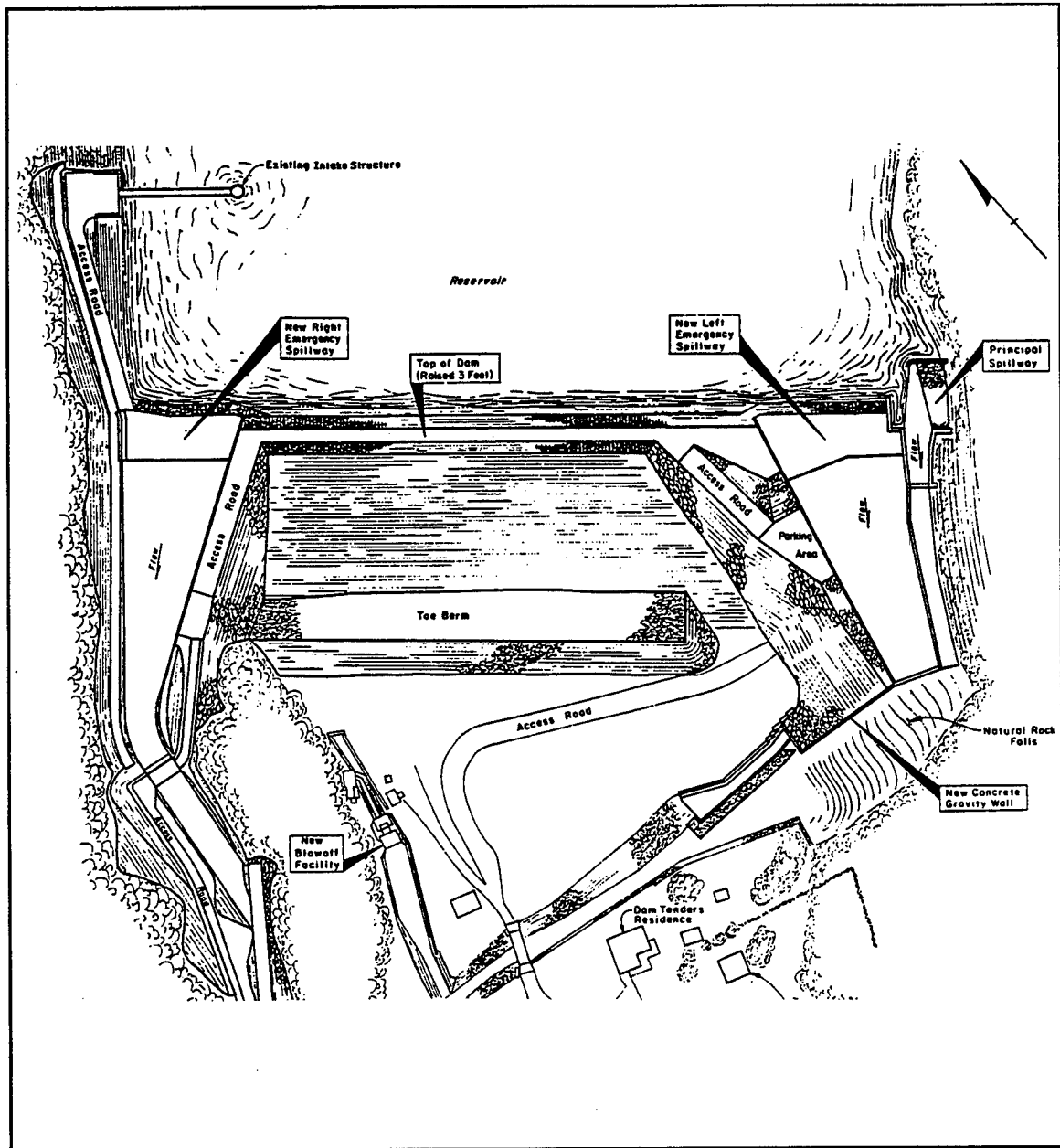

Figure 60. Modification plan for Saltlick Dam (courtesy of Bingham and Schweiger 1990, ASDSO). (Multiply feet by 0.3048 to obtain metres)

disturbance of the core material. At both abutments, the top of the dam would have to be excavated approximately 3.7 m (12 ft) to accommodate construction of the two emergency spillways. The excavation would expose a 9.1- by 38.1-m (30- ft by 125-ft) section of core material at each abutment. Data from laboratory tests indicated that if piles were driven into the core material, the results would be that the core material would then consolidate and thus create a gap between the pile-supported structure and the crest of the dam. Also, vibration and loading from the pile-driving operation could cause the core material to liquify, possibly producing local failures along the embankment. The solution was to use a

crane-operated shovel for excavating the embankment and to provide a foundation for the RCC that would allow for adequate compaction of the material. The base for the RCC slab consisted of a layer of heavy geotextile, covered with 0.9 m (3 ft) of specially blended impervious fill and then a 0.3-m- (1-ft-) thick slab of reinforced concrete.

A zone of highly permeable embankment material along the top of the dam was located during field investigations. The zone extended down to the hydraulic fill in some places; therefore, a decision was made to use a cement-bentonite slurry to construct an impervious cutoff between the core material and the raised top of the dam (Figure 61).

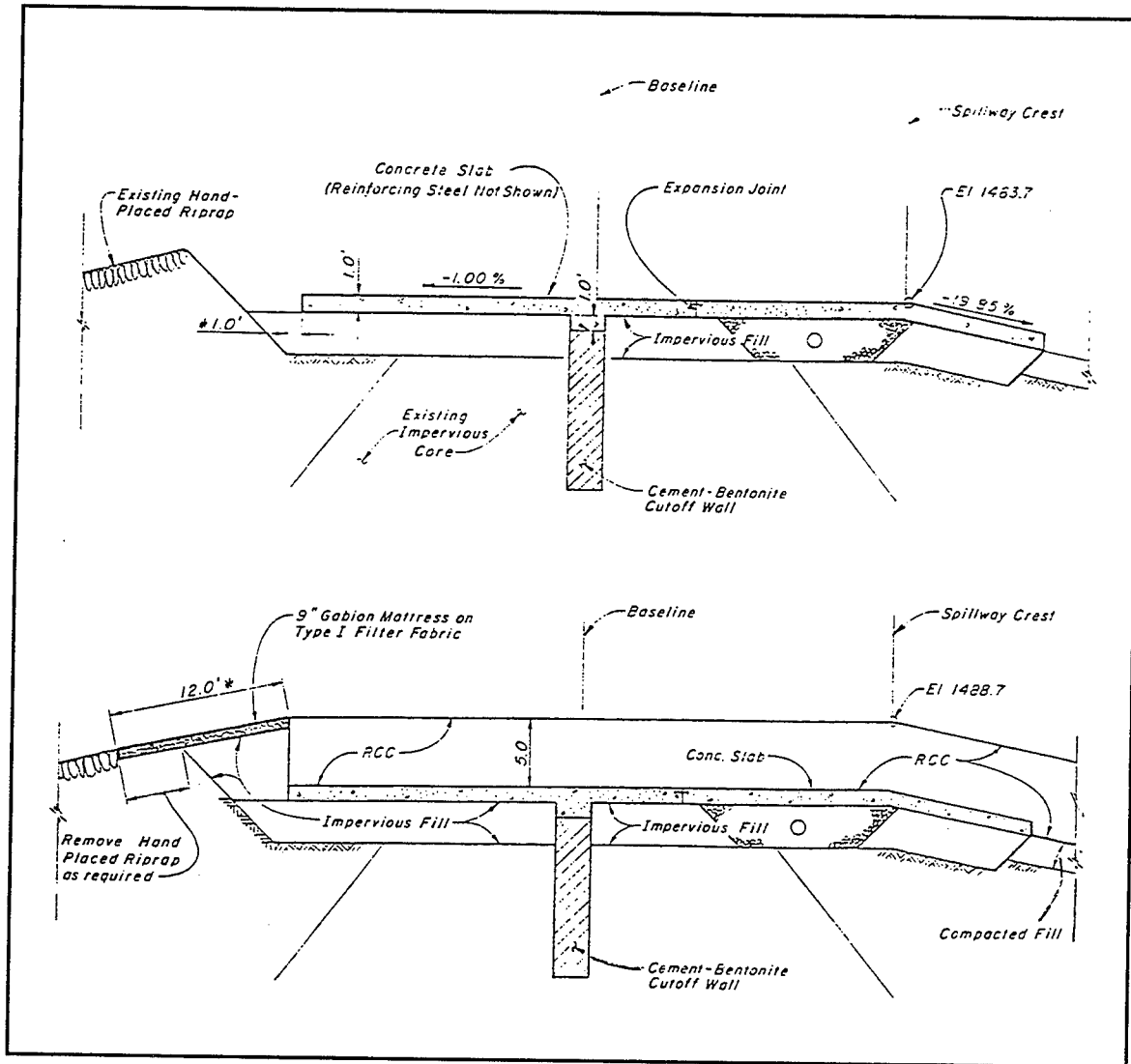

Figure 61. Spillway construction details at Saltlick Dam (courtesy of Bingham and Schweigher 1990, ASDSO). (Multiply inches by 25.4 to obtain millimetres and feet by 0.3048 to obtain metres)

Two RCC mixture proportions were used in construction of the emergency spillways. A lean, economical mixture with a 90-day compressive strength of 17.2 MPa (2,500 psi) was used as a base mixture. A mixture with a 28-day compressive strength of 20.7 MPa (3,000 psi) was used for the 0.6-m- (2-ft-) thick surface mixture. Aggregates were obtained from a commercial quarry. Coarse aggregate was AASHTO No. 76, and concrete sand was PennDOT Type A. Mixture proportions for the RCC were as follows:

Material	Weight, kg/cu m (lb/cu yd)	
	Base Mixture	Surface Mixture
Portland cement	86.0 (145)	151.3 (255)
Fly ash	86.0 (145)	151.3 (255)
Fine aggregate	789.1 (1,330)	1,079.8 (1,820)
Coarse aggregate	1,429.9 (2,410)	961.1 (1,620)
Water	112.7 (190)	130.5 (220)

Spillway side walls are reinforced concrete L-type walls built into the RCC spillway slab, except where the spillway is excavated into rock. Polyethylene sheeting was used as a bond breaker at the appropriate RCC lift elevation so subsequent lifts of RCC could be placed and later removed to neat lines. Overplacement of the RCC was necessary to obtain good compaction (Figure 62). A massive RCC end section on the left spillway was used in place of a large gravity retaining wall. The reinforced concrete liner-wall serves as a transition to the gravity spillway wall farther downstream.

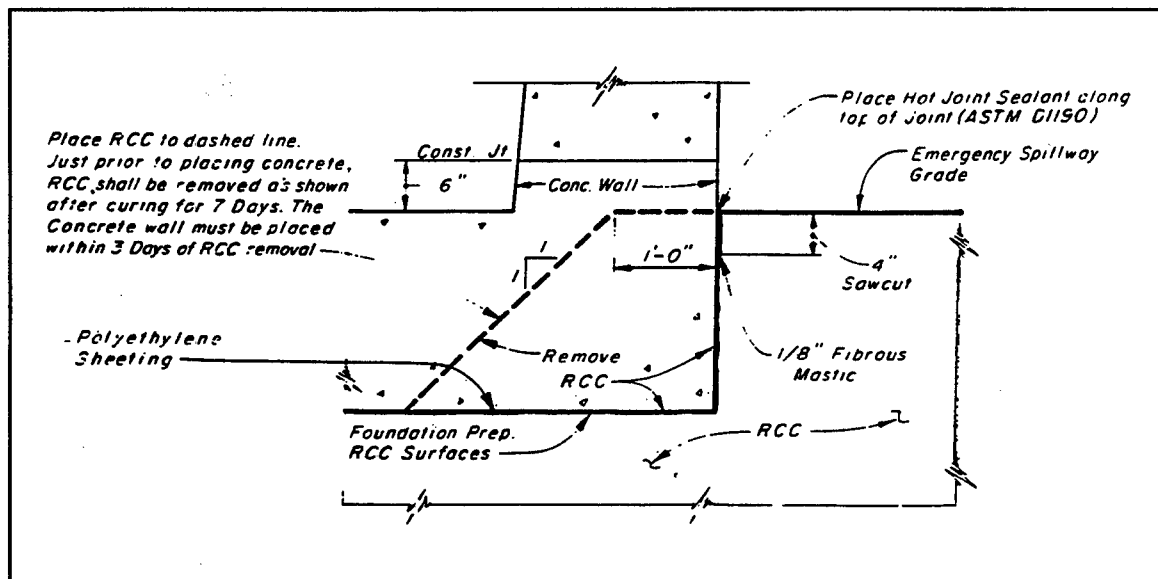

Figure 62. Detail showing RCC-concrete joint at Saltlick Dam (courtesy of Bingham and Schweiger 1990, ASDSO). (Multiply inches by 25.4 to obtain millimetres)

Obtaining good compaction of the RCC was sometimes difficult in areas where the RCC abutted an existing concrete structure. To fill voids that might occur in

these areas, a 0.6-m- (2-ft-) wide, 25-mm- (1-in.-) thick layer of bedding mixture was placed on the prepared foundation along the existing structure before the RCC was unloaded. When the RCC was spread and compacted, the bedding mixture squeezed up and against the abutting structure to form a bond.

The combined capacity of the existing spillway and the new emergency spillways is sufficient to pass the PMF. Over 8,410 cu m (11,000 cu yd) of RCC was used to construct the emergency spillways which can discharge flood flows in excess of the 100-year flood. The RCC design provided an estimated savings of nearly \$2 million compared to a conventional concrete design.

### **White Meadow Lake Dam**

White Meadow Lake Dam, owned and operated by the White Meadow Lake Property Owners Association, is located in Rockaway, NJ. The reservoir impounded by the dam has a 514,400 cu m (417-acre-ft) storage capacity and is used for recreation by local residents. The embankment dam is 91.4 m (300 ft) long and 4.6 m (15 ft) high with an 8.8-m- (29-ft-) wide broad-crested concrete spillway. On the upstream side of the dam, the embankment is retained by a vertical concrete wall, and the downstream side is retained by stone masonry walls. The spillway discharge capacity was insufficient to pass the design flood (1/2 PMF) for this small, high-hazard structure.

The remediation plan called for armoring the embankment with RCC to provide erosion protection during overtopping and extending the spillway outlet with a reinforced concrete section (Ditchey 1992). Plans also called for covering the RCC with topsoil and seeding it so the structure would be appropriate to the park-like setting of the dam area.

Since the engineering firm that was rehabilitating the dam was also performing similar work concurrently on other projects, a single laboratory program was initiated to develop an RCC mixture appropriate for each project. Results of the mixture proportioning study were previously described in the Lake Lenape Dam case study. Approximately 765 cu m (1,000 cu yd) of RCC were used in 1991 to armor the embankment. The engineer's total construction cost estimate was \$245,000.

### **Butler Reservoir and Soil Erosion Dams**

In 1990, 17 dams overtopped at Fort Gordon near Augusta, GA. The U.S. Army Engineer District, Savannah, decided to rehabilitate some of them with RCC. At Butler Reservoir Dam, RCC was used to armor plate the crest and the upstream and downstream faces of the dam and in construction of a spillway (Figure 63). At Soil Erosion Dam, RCC will be used to construct a 54.9-m- (180-ft-) long saddle spillway and stilling basin and to protect the crest and downstream slope from erosion in the event of overtopping.

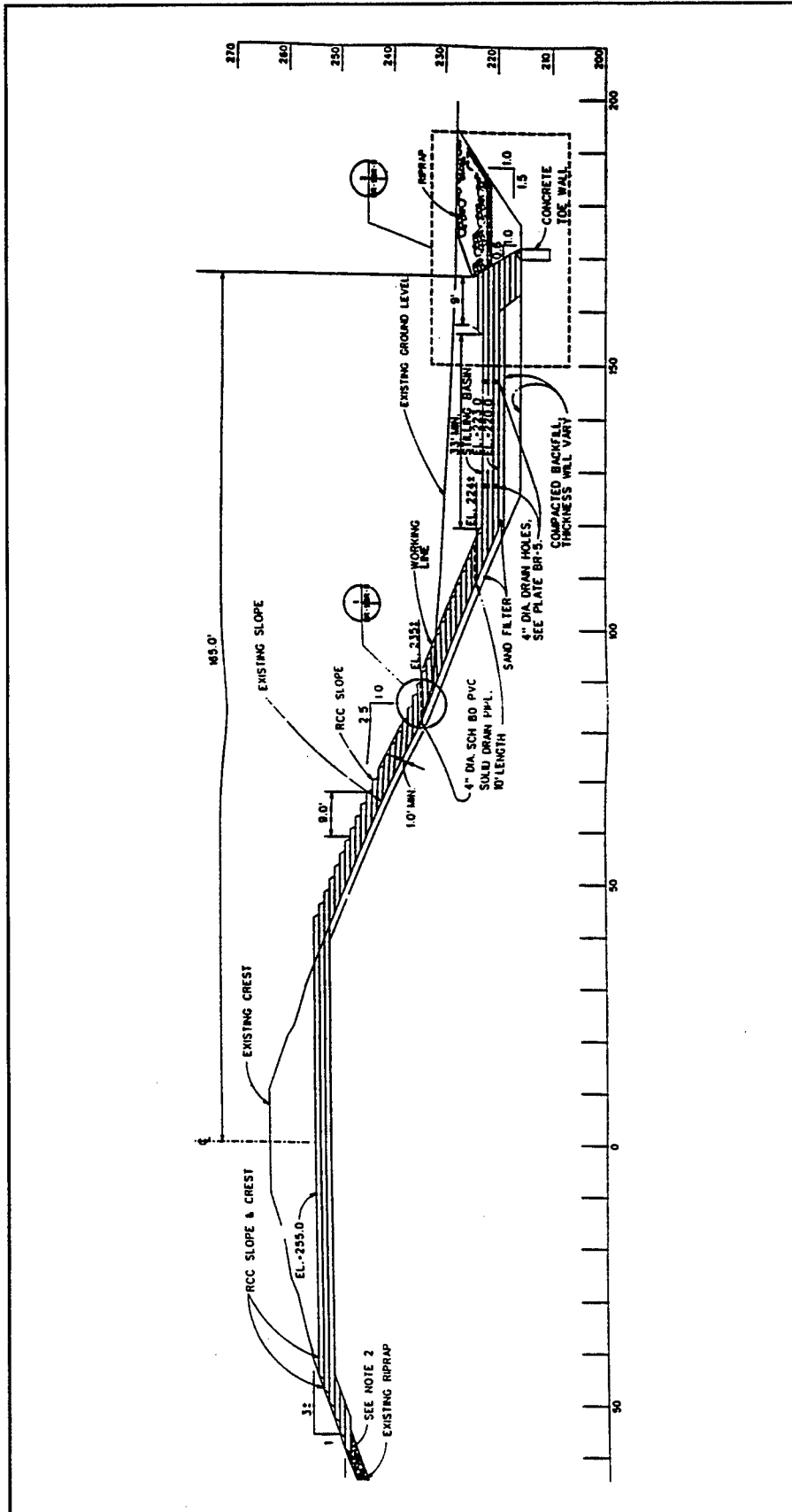

Figure 63. RCC modifications, Butler Reservoir Dam. (Multiply feet by 0.3048 to obtain metres)

RCC for each project consisted of aggregate, cementitious materials (portland cement and fly ash), and water. Aggregates were obtained from a commercial producer and stored in stockpiles at each site. Coarse and fine aggregates were required to conform to the requirements of ASTM C 33 (1975a). Portland cement and fly ash were required to conform to ASTM C 150 (1975c), Type I, and ASTM C 618 (1975d), Class F, respectively. The standard chemical requirements for ready mix concrete as established in ASTM C 94 (1975b) were used for water.

The RCC mixture was proportioned to (a) meet structural design loads, (b) minimize internal heat rise from hydration, thus reducing stress or crack potential, (c) maximize stress relaxation through creep and elastic properties, (d) provide a constructible mixture, and (e) be economical. Mixture proportions were as follows:

<u>Material</u>	<u>Weight, kg/cu m (lb/cu yd)</u>
Portland cement	132.3 (223)
Fly ash	96.1 (162)
Fine aggregate	803.9 (1,355)
Coarse aggregate	1,215.7 (2,049)
Water	148.3 (250)

The RCC was delivered to the placement site as quickly as possible. The total length of time from the end of mixing to delivery was not allowed to exceed 30 min. Prior to delivery of the RCC, all surfaces against which the RCC would be placed were dampened and rolled or tamped. A bedding mixture was proportioned so that the RCC could be spread on and compacted into it before it reached initial set. Placing lanes ran parallel with the axis of the dam and the RCC was raised to the same level across an entire area with continuous placement from bottom to top.

The RCC was spread within 10 min after being deposited. Lift thicknesses ranged from 254 to 305 mm (10 to 12 in.) after compaction with a vibratory roller to a minimum of 95 percent and an average of 98 percent of the AMD. Areas too small for roller compaction were compacted with hand-guided power tampers or plate vibrators. During compaction, the in-place moisture content of the RCC was maintained within plus or minus 0.5 percent of the moisture content computed for the mixture design being used.

Lift surfaces 12 hr or more old were coated with bonding mortar before the next lift was placed. Surfaces older than 3 days were cleaned with high-pressure water jet and then prepared as 12-hr old surfaces. All joint surfaces were fog sprayed between lifts and then surface dried just before placement of adjacent RCC. Permanently exposed surfaces were water cured for 7 days.

## Camp Dyer Diversion Dam

Camp Dyer Diversion Dam, located on the Auga Fria River about 56 km (35 miles) northwest of Phoenix, AZ, impounds a small reservoir used to divert irrigation releases from Waddell Dam to the Beardsley Canal. The dam, which was completed in 1926, is owned and operated by the Maricopa Water District. It is 22.9 m (75 ft) high and has a crest length of 182.9 (600 ft). To the west of Camp Dyer Diversion Dam is a 7.6-m- (25-ft-) high concrete gravity dike with a 80.2-m (263-ft) crest length. Irrigation releases from the reservoir are regulated by five slide gates within a canal headworks structure at the left abutment of the dam. Prior to modifications, releases that exceeded 17 cms (600 cfs), the canal capacity, overtopped the dam and dike crest and entered the Agua Fria River.

The Camp Dyer Diversion Dam had to be modified after USBR constructed the New Waddell Dam midway between the old Waddell Dam and the Camp Dyer Diversion Dam. The New Waddell Dam, which supplies storage for Reclamation's Central Arizona Project, significantly reduced the amount of storage available for canal releases in the lower lake. As a means of maintaining the original storage capacity of the lower lake, USBR agreed to raise the height of the Camp Dyer Diversion Dam. Design and construction of the dam modification is described in detail by Hepler (1992) and summarized in the following.

A design study indicated the dam crest would need to be raised to el 440 m (1,445.0 ft), about 1.2 m (4 ft) above the original crest. The modified dam would also have to meet current USBR criteria for static and dynamic stability of concrete gravity dams. By making sure the dam met these specifications, Maricopa Water District could ensure the dam's continued use for diversion releases and for supplying sufficient tailwater to operate the river outlet works through the New Waddell Dam.

Static and dynamic stability analyses were performed on the maximum section of the existing dam. The results showed that compressive stresses were within acceptable limits, and there were no tensile stresses for all loading conditions. However, the estimated factors of safety for sliding stability did not meet USBR criteria. To increase the dead load and the sliding resistance of the structure, a buttress was designed for the downstream face of the existing dam. USBR elected to use RCC for construction of the buttress rather than conventional concrete because of its relative economy and ease of construction.

The original design for the buttress specified a 4.6-m (15-ft) width and a downstream slope of 8H:1V. However, for final design the width was increased to 6.1 m (20 ft) to accommodate two lanes of traffic for the RCC lifts. A foundation concrete block was added to the maximum section below el 423.7 m (1,390.1 ft) within the river channel. The concrete block provided a longer and more uniform foundation for the RCC and reduced the overall amount of concrete required (Figure 64).

In preparation for placement of the RCC, the interior of the existing dam was grouted to reduce the overall permeability of the dam. Seepage pipes were

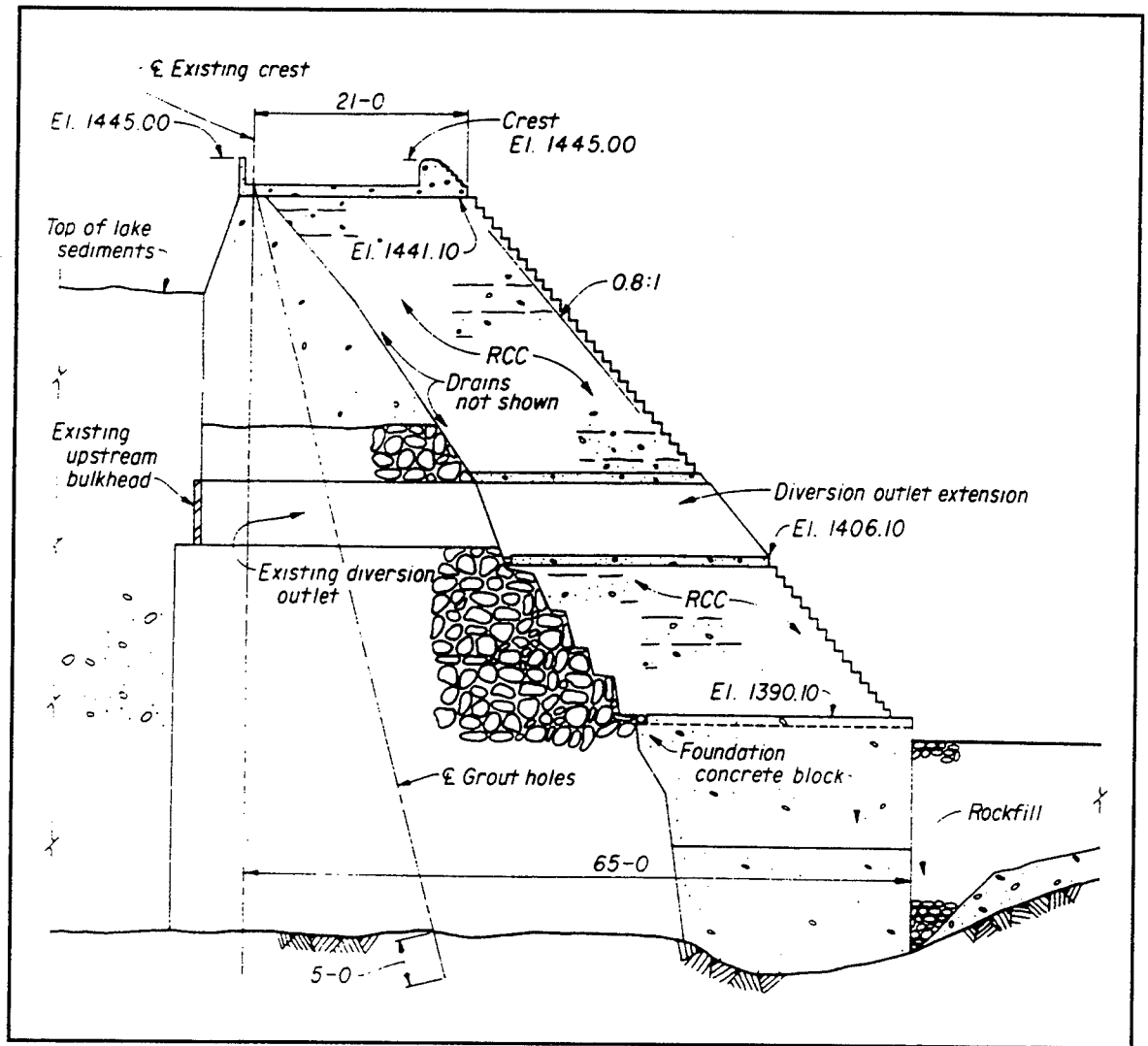

Figure 64. Cross section of modifications for Camp Dyer Division Dam (courtesy of Hepler 1992, ASDSO). (Multiply feet by 0.3048 to obtain metres)

installed, with all seepage being discharged downstream through outlet pipes beneath the RCC. While the dam was being grouted, a concrete foundation block was constructed for the maximum section of the dam, and RCC was being placed at the dike. Additional foundation preparation included filling depressions 76 mm (3 in.) or larger with dental concrete to facilitate RCC placement.

The RCC was proportioned by USBR for compressive strengths of 7.6 and 20.7 MPa (1,100 and 3,000 psi) at 28 days and 1 year, respectively. The 163 kg/cu m (275 lb/cu yd) of cementitious materials were equally divided between cement and pozzolan. Concrete sand and 38-mm (1-1/2-in.) maximum size aggregate were used. Air-entraining admixtures were added at a rate between two to three times that of conventional concrete with similar mixture proportions to achieve a total air content at placement of  $3.5 \pm 1$  percent. About



89 kg/cu m (150 lb/cu yd) of water produced the desired consistency with an average Vebe time of 13 sec.

A 6.1-cu m (8-cu-yd) batch plant with an output capacity of 115 cu m (150 cu yd) per hour was used for mixing the RCC. End dump trucks were used to transport the mixture to a hopper, which deposited it on a conveyor belt and radial stacker. A front-end loader was used to transport the RCC on the fill; a tracked D4 dozer was used to spread it, and a 10-ton, dual-drum vibrating roller that made a minimum of 6 passes on each lift was used to compact it in 0.3-m (1-ft) lifts. A single-probe nuclear density gauge was used to measure the density, which was then compared with the computed AMD of the control section. The average for any 10 tests was required to be not less than 99 percent of the control AMD, with all tests greater than 95 percent of the AMD, and no more than 1 test in 10 less than 98 percent of the AMD. A new AMD was required for each 2,300 cu m (3,000 cu yd) of RCC, and when the moisture content changed by more than 0.5 percent.

A lean mixture of leveling concrete from a commercial batch plant was placed at the sloping rock abutments and the contacts with the existing dam just prior to RCC placement (Figure 65). Leveling concrete was placed by bucket or front-end loader in 0.3-m- (1-ft-) wide 0.3-m (1-ft) lifts along the contacts and compacted with internal vibration. Before the initial set of the leveling concrete, the RCC was placed and compacted.

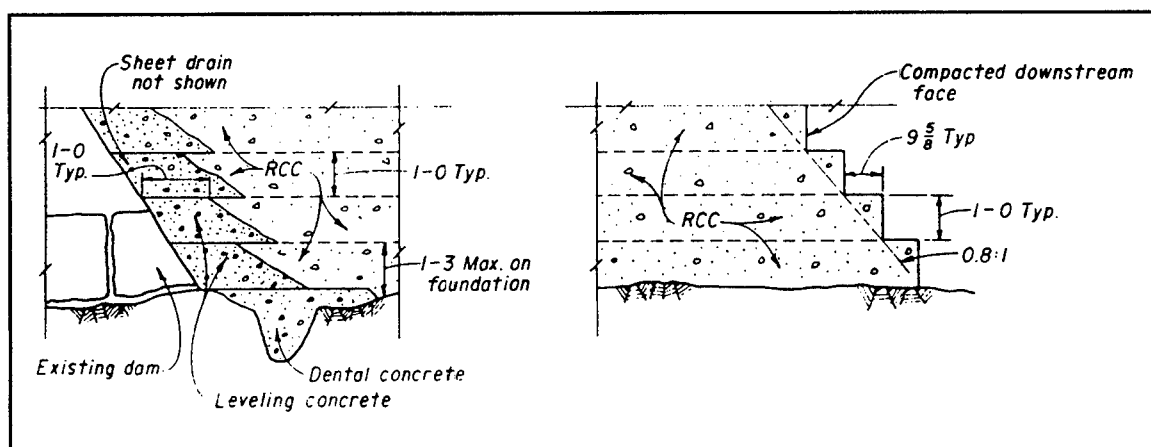

Figure 65. Details for RCC buttress at Camp Dyer Diversion Dam (courtesy of Hepler 1992, ASDSO)

Standard 0.3-m- (1-ft-) curb forms were used to construct the stepped downstream face (Figure 65). The forms were staked to preceding lifts and braced externally. To minimize segregation, the RCC was hand shoveled against the forms and compacted with a power tamper and plate vibrator. Surface repairs were normally not required following removal of forms.

All lifts more than 8 hr old were coated with bonding mortar before a subsequent lift was placed. Before the bonding mortar was applied, the surfaces

were cleaned with water and air-jetting. High-pressure water jets were used to clean surfaces more than 3 days old. The mortar was broomed in layers from 6 to 13-mm (1/4- to 1/2-in.) thick immediately ahead of the RCC.

Placement of RCC in the dike buttress began in February 1992 with 450 cu m (590 cu yd) placed in four lifts to meet prequalification requirements. The dike buttress was completed in March with the placement of an additional 1,210 cu m (1,580 cu yd) of RCC. Cores taken 2 weeks after placement generally exhibited well-bonded joints and few voids. Following completion of the foundation concrete block, RCC placement for the dam buttress began in April. Over 1,530 cu m (2,000 cu yd) of RCC was placed to the diversion outlet crown at el 1,413.1. Timbers at each 0.3-m (1-ft) lift were used to create a 1.8- by 24-m (6- by 8-ft) blockout for the diversion outlet extension so as not to interrupt RCC placements. Above el 1,426.1, the RCC lifts extended the full length of the dam; dump trucks were used to transport the RCC from the middle of each lift out to both ends.

RCC placed in May was injected with liquid nitrogen to control placement temperatures. Final placements were made at night when temperatures were lower. An average maximum temperature rise of 30 degrees was recorded in the dam buttress at about 17 days. RCC placement in the dam buttress was completed on May 29. The RCC buttresses were capped with a conventional, reinforced-concrete apron and ogee overflow crest.

Approximately 11,800 cu m (15,400 cu yd) of RCC was used in the dam and the dike. The bid price for the RCC was \$59.64/cu m (\$45.60/cu yd). Total cost of the project, including the construction of the RCC buttresses and associated work, was about \$3 million.

### **Horsethief Dam**

Horsethief Dam, which was constructed in the 1930s, is located in the Black Hills National Forest near Hill City, SD. The earth-fill dam is 19.8 m (65 ft) high and has a 167.6-m- (550-ft-) long crest. In the 1950s, the State Highway Department incorporated the dam into the main access route to Mount Rushmore. Traffic on the two-lane, paved highway on the dam crest sometimes amounts to as many as 11,000 vehicles per day. The dam is also important to the town of Keystone, which is located down the canyon from the dam. Concerned about the possible loss of life and the damage that would be done should the high-hazard structure be breached, the U.S. Forest Service, in 1992, decided to modify the dam to ensure that it could safely pass the PMF. The dam modification was reported by Bakeman (1993).

Options for modifying the dam were limited by the traffic and steep rock abutments. Alternatives considered were (a) construction of a wide-span bridge and chute spillway, (b) installation of a large culvert through the base of the dam to reduce flow, and (c) armoring the downstream face of the dam to provide overtopping protection. The third alternative was selected, and RCC was chosen

as the material for the armorplating. RCC was selected because it cost less than the other options. Cost estimates for the other options ranged from \$1,000,000 to over \$2,000,000; the contract for placement of 4,780 cu m (6,250 cu yd) of RCC covered with topsoil was \$436,209. Also, RCC placement would have less impact on the site, would allow for fall construction as scheduled, and would allow continued access to Mount Rushmore.

The Forest Service elected to use textbook mixture proportions for the RCC because the cost quoted for collecting aggregate field samples, laboratory mixture designs, and construction testing of the RCC was \$50,000. The RCC mixture used for the project consisted of well-graded, 76-mm (3-in.) minus commercially available concrete aggregates and relatively rich cement content of 193 kg/cu m (325 lb/cu yd). The mixture's resistance to cycles of freezing and thawing was more important than its having a high compressive strength, since the chance of the dam's being overtopped was about 1 percent annually.

The contractor prepared a test section for establishing maximum density for the RCC. RCC was placed in three lifts in the test section: the first lift served as a base; the second lift was tested for moisture and density after every two passes with a vibratory drum roller until the density did not increase or actually decreased. Water content was adjusted for the third lift. Once the maximum density was established, 95 percent of that value was specified as the minimum acceptable placement standard. The test section required about 23 cu m (30 cu yd) of RCC and was completed in 2 hr.

Prior to placement of the RCC, an average of 0.3 m (1 ft) of topsoil and vegetation was removed from the crest, downstream face, and toe area of the dam. In preparation for a cutoff trench and RCC placement on the road shoulder, 2 ft of soil was cut from the downstream edge of the pavement on the crest of the dam. A conventional concrete cutoff wall, 0.3 m (1 ft) wide and 0.9-m- (3 ft) deep was constructed under the upstream edge of the RCC to reduce seepage and possible uplift pressures at the crest of the dam. A 0.46-m- (1-1/2-ft-) wide by 1.2-m- (4-ft-) deep wall was installed at the downstream toe to protect the RCC edge from scouring. Although hydrostatic pressure buildup under the RCC layer was not a serious concern, a toe drain was installed as a precautionary measure.

RCC was delivered to the jobsite in 7.6-cu m (10-cu yd) dump trucks, transferred in a front end loader, spread in 2.4-m- (8-ft-) wide lifts with a dozer, and compacted with a vibratory drum roller (Figure 66). Specifications stated that compaction was to be completed within 1-1/2 hr; usually it was completed within 1/2 hr. No grout or other bonding material was used between lifts. The owner wanted to allow for seepage, and he felt that friction between the lifts and overflow water pressure on the rounded edges of the lifts would provide adequate stability for the expected flows. Placement of the RCC continued into November when, on some days, the aggregate and water temperatures were about 4.5 deg C (40 deg F) and ambient temperatures were about -2 deg C (28 deg F) in the morning with a daytime high of 1.1 deg C (34 deg F). Each night the top of the lift was covered with concrete insulation blankets or plastic sheeting and the face with 305 mm (12 in.) of earth fill (Figure 67). The next morning concrete

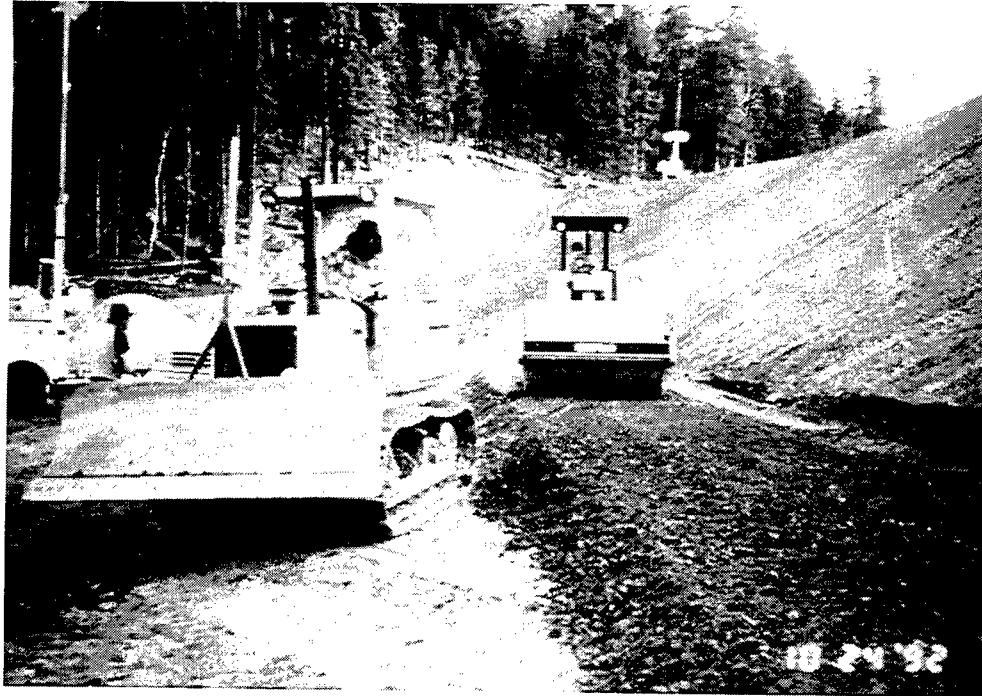

Figure 66. RCC placement at Horsethief Dam



Figure 67. Lift surface covered with blankets and face covered with topsoil, Horsethief Dam

surface temperatures were 15.7 deg C (60 deg F) under the blanket, 10 deg C (50 deg F) under the plastic sheeting, and 18.5 to 21.3 deg C (65 to 70 deg F) under the earth fill. The RCC was cured with water; no overnight watering was necessary as the RCC was damp in the mornings without it.

A vibratory hammer was used to prepare 152-mm- (6-in.-) diam cylinders for compressive strength testing. Cylinders were cast on October 31 and November 11, 1992. results of compressive strength tests were as follows:

	7 days, MPa (psi)	28 days, MPa (psi)	90 days, MPa (psi)
October	9.7 (1,400)	15.0 (2,180)	17.4 (2,520)
November	28.2 (4,090)	25.5 (3,700)	25.5 (3,700)

Although no minimum compressive strength had been specified, strengths between 13.8 and 17.3 MPa (2,000 and 2,500 psi) after 28 days had been expected. The wide range in the 7-day test results was not explained, although it was suggested that the large-sized aggregate might have been a factor.

In response to the District Forest Ranger's request for a green dam, the RCC was covered with the topsoil and grass that had been excavated for placement of the RCC. In addition to its aesthetic value, it is believed that the soil cover will provide additional protection against freezing, thus extending the life of the RCC.

Based on his experience at Horsethief Dam, Bakeman (1993) offers several suggestions for improvements on future projects, including:

- a. Maximum size aggregate should be reduced from 76 mm to 38 or 50 mm (3 in. to 1-1/2 or 2 in.). The larger-sized aggregate caused problems, including segregation when the mixture was spread with a dozer and collections of stone pockets without adequate fines to seal the surface. Also, cement should be increased to 237 or 267 kg/cu m (400 or 450 lb/cu yd) for RCC that will be exposed to frequent flows.
- b. 100 percent compaction should be specified with only 5 percent of the readings below 97 percent. Percentages should be the average of four readings taken at 90 deg around a single nuclear probe hole; the probe should be extended 203 mm (8 in.) into the lift.
- c. Front end loaders should be confined to compacted lifts with a maximum of one trip allowed across an uncompacted lift. Loaded front end loaders should be used to make one tire pass on the noncompacted edge of each lift to improve durability. New lifts should be started from the end of the dam opposite from the RCC supply.

## **Meadowlark Dam**

Meadowlark Dam, which was constructed in the 1930s by the Civilian Conservation Corps, is located near Tensleep, WY, in the Bighorn National Forest. The earth-fill dam is 8.5 m (28 ft) high with a 106.7-m- (350-ft-) long crest and a 9.1-m- (30-ft-) wide ogee concrete spillway. The spillway is adequate for a 100-year-storm event, but there was concern the dam would be breached in the event of the PMF. In 1922, the U.S. Forest Service decided to modify the dam so it could safely pass a PMF (Bakeman 1993).

Modification options considered included (a) cutting an abutment spillway into bedrock and raising the dam crest, (b) constructing a fuseplug spillway in the dam fill, and (c) armoring the crest of the dam with a conventional concrete ogee spillway. Estimated cost for these plans ranged from \$500,000 to \$1,200,000. Therefore, the Forest Service opted to armor plate the crest and downstream slope of the dam with RCC. The contract cost for this option, which included placing approximately 1,900 cu m (2,500 cu yd) of RCC, patching spalled areas in the concrete spillway, and repairing a section of hand-placed riprap wave protection was \$266,046, a significant savings over the other options. The unit bid price for the RCC was \$86.85/cu m (\$66.25/cu yd).

The similarities between Meadowlark and Horsethief Dams allowed for effective use of nearly identical designs and specifications. Modifying both dams the same year with similar specifications attracted good contractors and two competitive bidders who each got one of the jobs. Choosing clean concrete aggregate over bank-run local aggregates proved to be cost effective for the small quantities of material needed for the projects. The Meadowlark contractor chose to pay \$32.70/cu m (\$25/cu yd) for aggregate trucked 80 km (50 miles) uphill rather than the uncertain cost of preparing the aggregate out of the gravel pit used for the RCC mixing site. RCC mixture proportions, placing procedures, and quality controls were essentially the same as those previously described in the Horsethief case study. Approximately 1,900 (2,500 cu yd) of RCC were placed in 4-1/2 days and then covered with topsoil.

A vibratory hammer was used to prepare 152-mm- (6-in.-) diam cylinders for compressive strength testing. Results of the tests were 31.5 MPa (4,500 psi) at 7 days, 19.5 and 20.6 MPa (2,830 and 2,990 psi) at 28 days, and 28.8 MPa (4,170 psi) at 56 days. Although no minimum compressive strength had been specified, strengths between 13.8 and 17.3 MPa (2,000 and 2,500 psi) after 28 days had been expected. There was no explanation for the high strength at 7 days.

## **North Potato Creek Dam**

North Potato Creek, a tributary of the Ocoee River, is located near Copperhill, TN, a mining community that has been active since the early 1900s. Because of extensive mining, all vegetation on approximately 70 percent of the creek's 33.7-sq-km (13-sq-mile) drainage basin had been destroyed by the 1940s.

When a new surface mine was proposed in 1974, North Potato Creek Dam was constructed to divert storm runoff from the creek's drainage basin into an adjacent watershed. The dam is a 28-m- (92-ft-) high, 244-m- (800-ft-) long zoned earth-fill structure. Minimum flow rates below the dam were provided with a 762-mm (30-in.) low-level pipe through the base of the dam. A 762-m- (2,500-ft-) long, 4-m- (13-ft-) diam tunnel in the left abutment served as a secondary principal spillway. An emergency spillway channel with a 61-m- (200-ft-) wide control section was located on the left abutment above a section of the tunnel.

In 1985, the mine below the diversion dam was closed. In 1990, new state and Federal water quality standards were mandated for both North Potato Creek and Davis Mill Creek. Because Davis Mill Creek flows through an industrial complex, its water had to be treated before it was discharged into the Ocoee River. A solution that would help both streams was to convert North Potato Creek into a sediment pond, thereby reducing the amount of storm water entering Davis Mill Creek. The conversion of North Potato Creek would be accomplished by closing the low-level spillway pipe and sealing the tunnel. However, the lost spillway capacity would have to be replaced so the dam could safely pass the PMF. Modification of the dam is described by Bass (1992) and summarized in the following.

The modification plan was to convert the existing earth emergency spillway into a principal spillway capable of passing the PMF. Following a review of the runoff characteristics of the drainage basin and the rock profile in the control section and along the spillway, a decision was made to lower the elevation of existing spillway inlet by 1.2 m (4 ft) and to narrow its width to 30.5 (100 ft). This change would enable the dam to pass the PMF of 9,630 cms (34,000 cfs) with a normal pool elevation. However, the rock was not considered durable enough to serve as a principal spillway for the control section and the first 61 m (200 ft) of the outlet channel, so surface protection had to be provided.

An analysis of various spillway materials showed that RCC would be the most economical choice. The RCC was to be placed in a stepped profile on the 5:1 channel slope to help aerate the water and dissipate energy (Figure 68). The completed spillway would have a 30.5-m- (100-ft-) wide control section that would narrow to 18.3 m (60 ft) at the base. The RCC would be thick enough to resist the maximum potential uplift forces, and an underdrain system would collect seepage beneath the spillway.

The specified compressive strength for the RCC was 17.2 MPa (2,500 psi) at 1 year. The designer elected to use the same RCC mixture proportions for this project that he had used successfully at Freeman Diversion Dam in California. The mixture proportions were as follows:

Material	Weight, kg/cu m (lb/cu yd)
Portland cement	100.9 (170)
Fly ash	65.3 (110)
Fine aggregate	735.7 (1,240)
Coarse aggregate	1,373.5 (2,315)
Water	94.9 (160)

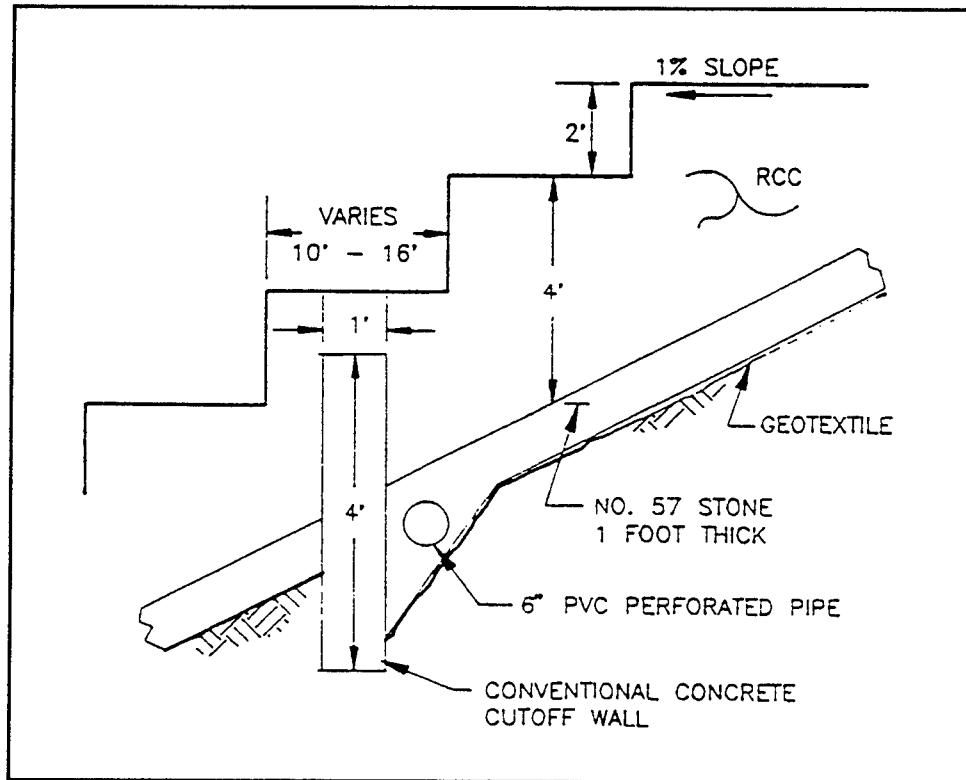

Figure 68. Cross section of RCC spillway design for North Potato Creek Dam (courtesy of Bass 1992, ASDSO). (Multiply inches by 25.4 to obtain millimetres and feet by 0.3048 to obtain metres)

An onsite pugmill could not be justified because of the relatively small volume of RCC; therefore, it was decided to use a ready-mix plant 19 km (12 miles) from the project to batch the RCC with mixing in transit mixers. A test section was placed and compacted next to the ready-mix plant to verify the strength and consistency of the mixture. A minimum mixing time of 10 min including 5 min at the placement site was selected. After examining cores taken from the test section, the designer decided to specify that the minimum dynamic force exerted by the vibratory roller should be 89,000 N (20,000 lb) to ensure full depth compaction of 0.3-m (1-ft) lifts. Test cylinders and cores from the test section exhibited compressive strengths ranging from 9.7 to 11 MPa (1,400 to 1,590 psi) at 28 days.



The project was bid on two occasions. The first invitation for bids attracted only one bidder, who submitted a bid of \$454,377 with the RCC priced at \$127.16/cu m (\$97.22/cu yd). The owner elected to advertise the work a second time and have a prebid conference at the site. Seven potential bidders from the local area attended the prebid conference. Only one potential bidder had experience in placing RCC. Four contractors bid on the project with in-place RCC costs ranging from \$85.68 to \$127.16/cu m (\$65.51 to \$97.22/cu yd). Factors which contributed to the higher than usual bids were the location of the project, the relatively small volume of the RCC, and the inexperience of the local contractors. The total project cost was \$407,655, excluding site preparation. The contractor was allowed 48 working days to complete the job.

The owner completed site preparation on April 15, 1992, and the contractor mobilized his forces over the next several days. One construction problem encountered by the contractor was how to provide a way for the transit mixers to access the spillway channel on the 5:1 slope. He solved the problem by constructing three reinforced concrete keyways before installing the geotextile, the stone, and perforated pipe for the underdrain system. He then built an RCC ramp down the center of the spillway channel to serve as a haul road.

RCC was placed from the bottom of the embankment to the top. The steps were formed by 0.6-m- (2-ft-) high panels supported by strong backs. Placement of RCC on the lower steps was slow because only one truck could back down the RCC ramp at a time. The RCC was discharged into a pile and then spread with a dozer in 0.3-m (1-ft) lifts. The lifts were compacted with one static pass, followed by four to five vibratory passes, and then a final static pass of a single-drum roller. A wacker packer and a walk-behind vibratory roller were used against the forms and around the underdrain.

Initial RCC placements consisted of two 10-hr shifts with a maximum placement of 286 cu m (374 cu yd) in one shift. Because of access problems at the bottom of the spillway channel, placement rates were limited until the spillway approached the control section. After that, up to four trucks could discharge at any one time, but discharge time approached 10 min. The transit mixers provided a ready source of potable water for keeping the RCC working surface moist, particularly during the day.

Because of bad weather and equipment breakdowns, it was necessary to use a bonding grout on RCC surfaces that were exposed for over 2,000 deg hr. Proportions for 0.8 cu m (1 cu yd) of the bonding grout were 112.7 kg (190 lb) of water, 118.7 kg (200 lb) of cement, 59.3 kg (100 lb) of pozzolan, and 2,136 kg (3,600 lb) of sand. Approximately 65.6 kg (110 cu yd) of grout was used on the project.

To maintain quality control, the contractor assigned an engineer or technician to each shift. The quality control program consisted of conducting consistency tests with a vibrating Vebe table, preparing test cylinders, determining in-place densities with a nuclear density gauge, and measuring RCC mixture temperatures. The average AMD ranged from 2,279 to 2,441 kg/cu m (142.3 to 152.4 pcf). All

of the nuclear gauge density readings averaged 98 percent of the maximum dry density. Only one section of the spillway (15.3 cu m (20 cu yd)) had to be removed and replaced because of poor compaction. Properly preparing the test cylinders was a difficult task. A rotary hammer fitted with a 95-mm- (3-3/4-in.-) diam steel plate was used to compact three lifts of RCC into the cylinder molds.

Cylinders for compressive strength test were moist cured and then tested at 7, 28, and 56 days. Compressive strengths at 7 days ranged from 4.9 to 7.2 MPa (707 to 1,040 psi); at 28 days from 7.6 to 8.8 MPa (1,096 to 1,270 psi); and at 56 days from 7.8 to 9.3 MPa (1,132 to 1,355 psi). Because of the low compressive strengths and the segregated look of these cylinders, the contractor felt they were not representative of the RCC in place. Eight cores ranging in length from 762 to 914 mm (30 to 36 in.) were taken from the completed spillway. Compressive strengths of the cores ranged from 12.3 to 27.3 MPa (1,780 to 3,950 psi), with an average of 17.9 MPa (2,602 psi). The ages of the cores at time of test ranged from 36 to 56 days. In most of the cores, lift lines and the interface between the RCC and the conventional concrete keyway wall were not visible.

Approximately 3,440 cu m (4,500 cu yd) of RCC were placed between April 20 and May 5, 1992. Based on his experiences during the design and construction of the RCC spillway, Bass (1992) recommends (a) that the moisture content of the RCC be maintained so that very slight pumping will occur to produce less honeycombing at the face of the forms; (b) that the work be accomplished between 6:00 P.M. and 8:00 A.M. so placement rates improve because of better placement conditions and because haul trucks encounter less traffic at night; (c) that all spillway underdrain and vent pipes be located outside the limits of RCC because protruding pipes make RCC placement more difficult; and (d) that standby equipment be provided to eliminate lost time caused by equipment breakdown.

### **Philipsburg Dam No. 3**

Philipsburg Dam No. 3, which was constructed between 1917 and 1921, is located on Cold Stream in Rush Township, Pennsylvania. The reservoir impounded by the dam has a storage capacity of 98,700 cu m (80 acre-ft) and is used as a water supply for the town of Philipsburg. The embankment dam is 5.5 m (18 ft) high and 73.2 m (240 ft) long with a 16.8-m- (55-ft-) wide uncontrolled spillway. Following an inspection, the dam was classified as a small, high-hazard dam (Ditchey 1992).

The dam received the high-hazard rating because of inadequate spillway capacity and failure of some sections of the spillway training walls. Two alternatives for rehabilitating the dam were considered. The first alternative was to replace the existing spillway. The new concrete spillway would be wide enough so that in conjunction with raising the remaining embankment slightly, the dam would be able to safely pass the spillway design flood (SDF). Estimated cost for this alternative was \$1,700,000. The second alternative was to replace the

failed spillway sections and to armor the embankment section to allow overtopping. Because of the experience gained at Lake Lenape Dam, New Jersey, the engineering firm hired to do the rehabilitation work recommended the second alternative and proposed RCC as the armor material.

The rehabilitation plan included removal of the existing topsoil from the crest and downstream embankment, covering the crest and embankment with 0.3-m- (1-ft-) thick filter material, and placing the RCC in 0.3-m- (1-ft-) thick horizontal lifts. Extending the RCC 6.1 m (20 ft) beyond the downstream toe forms an apron that provides scour protection. Since the engineering firm that was rehabilitating the dam was also performing similar work concurrently on other projects, a single laboratory program was initiated to develop an RCC mixture appropriate for each project. Results of the mixture proportioning study were previously described in the Lake Lenape Dam case study. The engineer's cost estimate for the RCC was \$131/cu m (\$100/cu yd) in place with approximately 1,070 cu m (1,400 cu yd) of RCC required to complete the project. The total construction cost estimate was \$1,100,000.

### **Ponca Dam**

Ponca Dam is one of several small dams on The Rosebud Sioux Indian Reservation in South Dakota. Constructed in 1935 by the Civilian Conservation Corps (CCC) to provide water for livestock, farm irrigation, and recreation benefits, Ponca Dam is a 10.7-m- (35-ft-) high earthfill structure with a 144.5-m- (474-ft-) long crest. The dam had a 7.6-m- (25-ft-) wide concrete service spillway, an uncontrolled auxiliary spillway, and low-level outlet works. For safety reasons the reservoir was drained in 1986 (Rogers and Calvino 1992).

As part of an evaluation of the dam, Harza engineers calculated the inflow design flood (IDF) according to criteria set forth by the Federal Energy Regulatory Commission. The criteria provides for protecting the dam against failure for a flood, not greater than the PMF, at which a theoretical dam failure would produce less than a 0.6-m (2-ft) rise in river stage at the first habitate structure affected. The calculated PMF and IDF for Ponca Dam are the same, 855 cms (30,200 cfs). The spillway capacity was 1,082 cms (3,800 cfs) (13 percent of the PMF); thus, the spillway needed to be expanded to handle an additional 748 cms (26,400 cfs) (Rogers and Calvino 1992).

Several methods for increasing spillway capacity were evaluated: armor the dam to allow overtopping; construct supplemental spillways, including fuse plug emergency spillways; widen the existing emergency spillways; and implement nonstructural methods including emergency action/warning systems. The IDF requirement, site conditions, and available funds were the factors that determined the choice of a rehabilitation method. On this basis, the recommended alternative was to raise the dam by 3 m (10 ft) and construct a new combined service-emergency spillway through the center of the dam. The existing service spillway was to be filled in and closed off with a small dike. The new spillway was to be a

stepped structure constructed with RCC. Calvino and Rogers (1994) describe the design approach and methodology for the RCC chute spillway.

In order to reduce the overall project cost, Harza engineers elected to use a thin RCC chute spillway 51.8 m (170 ft wide), similar to overtopping protection, and thick RCC training walls (Figure 69). The spillway crest is 0.6 m (2 ft) thick and covers an area of 15.2 by 54.9 m (50 by 180 ft). The spillway slab and training walls were produced by 0.3-m- (1-ft-) thick by 24-m- (8-ft-) wide compacted RCC lifts. The stilling basin is 54.9 m (180 ft) wide, and 13.7 m (45 ft) long with a 2.4-m- (8-ft-) thick floor slab. The stilling basin includes baffle blocks spaced at 1.2 m (4 ft) on centers and 0.6-m- (2-ft-) high end sill. The baffle blocks were the only part of the rehabilitation which used conventional reinforced concrete. A 1.2-m (4-ft) thickness of riprap was placed 9.1 to 15.2 m (30 to 50 ft) downstream of the stilling basin to prevent erosion of the toe.

Materials for the RCC were measured volumetrically and mixed in a continuous pugmill plant onsite. Accuracy of the plant was typically within 2 percent of designed quantities; however, at times the sand content varied because of sand bulking in the hopper. RCC was delivered to the site with conveyors and placed with a ROTEC crawler placer. Production rates ranged from 124 to 523 cu m (162 to 684 cu yd) per day. The primary factor affecting the rate of production was the time required to move forms for the spillway steps and sloping training walls. The contractor used 0.6- m- (2-ft-) high forms (Figure 70) which were easily moved, but it took 2 to 3 hr to remove form anchors and reset the forms for the next lift. Since RCC placement averaged 1.2 m (4 ft) per day, the forms required movement at least once during the day (Calvino 1993). The 5,900 cu m (7,700 cu yd) of RCC used in the project was placed in 17 days. Cost for RCC materials and placement, including forming the downstream steps, was \$86.69/cu m (\$66.28/cu yd).

Horizontal joints were included in the spillway in an attempt to control random cracking. A 0.9-m- (3-ft-) wide continuous piece of reinforced geomembrane was placed under each joint (Figure 69) to minimize the potential for loss of embankment material through the joints. Placement of the geomembrane on the embankment prior to RCC placement presented no construction problems, except the dozer operator spreading the RCC had to be careful not to tear the membrane. There were no particular technical requirements for forming the joints, except that the two slab sections should be separated above the geomembrane liner and the joint should be constructed with little or no gap (Calvino and Rogers 1994). The joints were constructed with steel plates wrapped in plastic. After the RCC was placed on both sides of the joint, the steel plate was removed and the plastic left in place as a bond breaker.

Joints were also placed parallel to the direction of flow to minimize the potential for shrinkage cracking in the spillway chute. Joints were formed next to the training walls to allow the slab to shrink away from the rigid RCC walls. However, some minor shrinkage cracks did develop about 1 month after

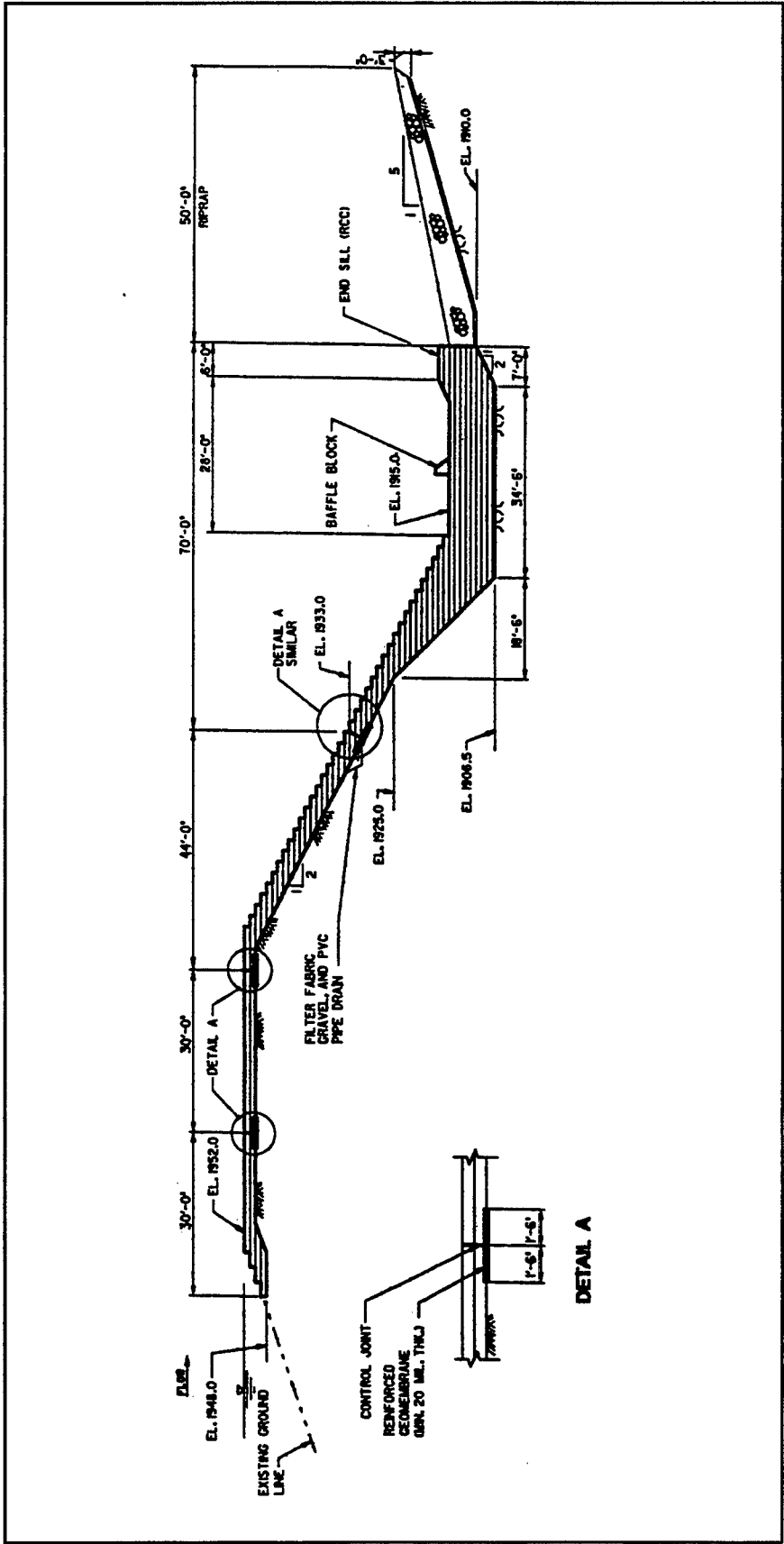

Figure 69. Section through Ponca Dam spillway (courtesy of Calvino and Rogers 1994, ASDSO). (Multiply inches by 25.4 to obtain millimetres and feet by 0.3048 to obtain metres)

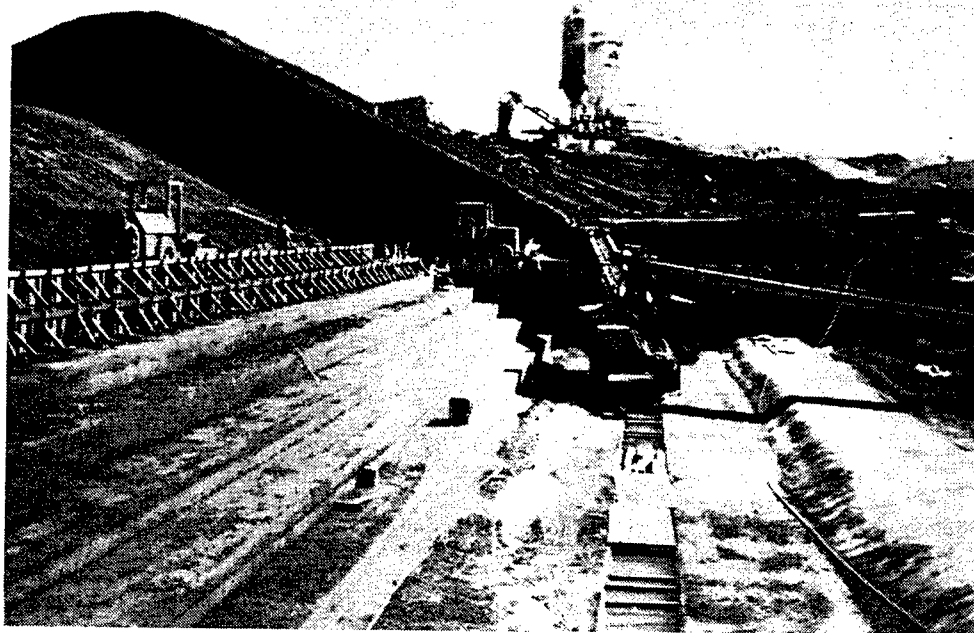

Figure 70. RCC placement operations, Ponca Dam spillway (courtesy of Calvino 1993)

completion of the RCC placement. The completed spillway is shown in Figure 71.

### Rosebud Dam

Rosebud Dam is located on Rosebud Sioux Indian Reservation at the confluence of the east and west branches of Rosebud Creek near the town of Rosebud, SD. The dam was constructed by the Civilian Conservation Corps (CCC) in 1935 to provide irrigation and recreation for tribal members. The dam is a homogeneous earth-fill structure, 11.3 m (37 ft) high with a 8.5-m- (28-ft-) wide crest that is approximately 122 m (400 ft) long. The spillway is an uncontrolled drop inlet structure consisting of three 1.7-m (5.5-ft) square concrete box culverts through the lower part of the dam. A low-level outlet works consists of a 10-mm- (24-in.-) diam gated conduit. The existing discharge capacity was about 57 cms (2,000 cfs).

A safety evaluation of Rosebud Dam was conducted by the USBR in 1984. The inspection showed that the embankment had deteriorated as a result of erosion, tree growth, and seepage, and that spillway capacity was inadequate. A deficiency verification analysis was conducted by the USBR in 1990. This analysis indicated that in the event of the PMF (3,580 cms (126,500 cfs)), the dam would be overtopped by 7.2 m (23.6 ft). A study of flood routings indicated that overtopping could begin at 2.5 percent of the PMF and could result in the dam being breached. There was no increase in potential for loss of life for floods

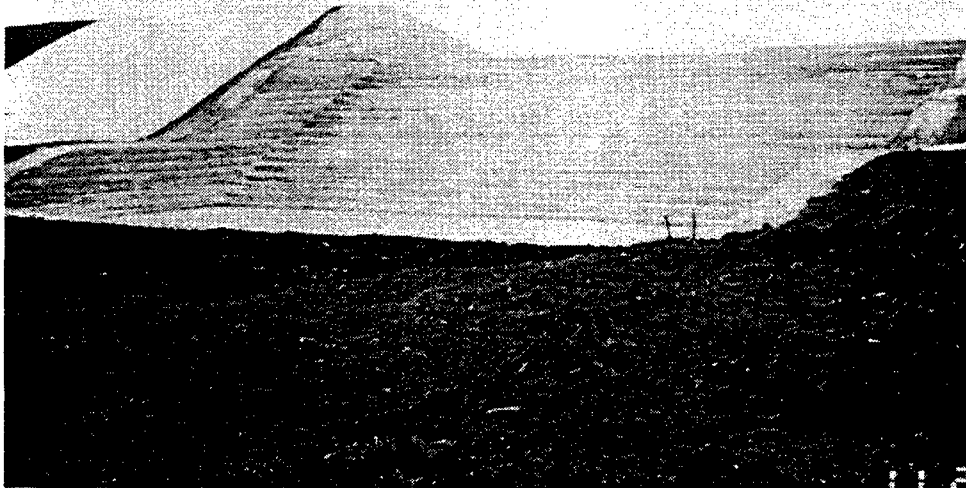

Figure 71. Completed spillway, Ponca Dam (courtesy of Calvino 1993)

greater than 10 percent of the PMF, but the Tribe desired additional protection for the dam because of recreational benefits provided by the reservoir. Considering economics, and the magnitude of the PMF, it was decided to make the inflow design flood (IDF) equal to the breach discharge for the dam (Rogers and Calvino 1992). The IDF was 390 cms (20,800 cfs), thus requiring 530 cms (18,800 cfs) in additional spillway capacity.

Several alternatives were considered for modifying the dam: (a) raising the existing dam and constructing an auxiliary spillway, (b) raising the existing dam and constructing a service spillway over the center of the dam, (c) constructing RCC overtopping protection on the crest and downstream face of the dam, (d) constructing soil-cement overtopping protection on the crest and downstream face of the dam, (e) constructing a 51.8-m- (170-ft-) wide service spillway over the center of the existing dam, and (f) making no modifications, but correcting operation and maintenance. The RCC overtopping protection alternative was selected because it was the most cost effective and would require the least amount of construction time. Also, RCC is more resistant to freezing and thawing than soil-cement, and it has low heat of hydration (Huq and Whiting 1993).

The final modification plan included overtopping protection with toe drains (Figure 72). RCC was placed across the crest, on the downstream face, and keyed into the bedrock. RCC was also placed on both abutments downstream of the dam for a distance of 30.5 m (100 ft). Placing RCC on the face and abutments resulted in a U-shaped placement.





Site preparation for the project began in September 1992. Concurrent laboratory tests were conducted to determine the proportions for the RCC mixture but RCC placements were delayed until April 1993 because of seepage problems at the dam and the onset of winter.

The contractor elected to use a local concrete supplier to save the cost of leasing a pugmill. The feasibility of using a batch plant and transit mixers was demonstrated in a small test section. The RCC was batched in a central plant located about 1.6 K (1 mile) from the dam. Three to six transit mixers were used to mix and transport the RCC to the site. Six-cu-m (8-cu-yd) batches of RCC were mixed in transit mixers with 6.5- and 8-cu- (8.5- and 10.5-cu-yd) capacities. Generally, uniform mixing of the RCC was accomplished with a minimum of 120 revolutions of the drums on the trucks; in the few cases in which it was not, the RCC at the beginning of discharge had no-slump consistency, but by the end of the truckload it had about a 50-mm (2-in.) slump (Calvino 1993).

Initially, the trucks attempted to discharge the RCC on level ground; however, when it became apparent the trucks needed to be on a slope to expedite discharging, earth ramps were constructed along the top of the dam, and the RCC was discharged into the hopper of a mobile conveyor that transported it to the placement site. Two trucks were able to discharge onto the conveyor simultaneously. Along the left abutment, trucks could back down the 5H:1V slope and discharge directly onto the placement area (Figure 73). Discharging a truck took about 8 min on the ramps and 5 min on the left abutment (Calvino 1993). Following placement, the RCC was spread with a dozer and rolled.

The RCC was placed in a stepped configuration in 0.3-m- (1-ft-) thick lifts. The lifts were 2.4 m (8 ft) wide on the 2H:1V slope of the embankment, 3.7 m (12 ft) wide on the 3.5H:1V slope of the downstream right abutment, and 4.6 m (15 ft) wide on the 5H:1V slope of the downstream left abutment. Minimum concrete thickness perpendicular to the slope was 0.6 m (2 ft). The edges of the RCC lifts were not formed or compacted. The contractor was able to place RCC at a peak rate of 65 cu m (85 cu yd) per hr and averaged placing about 54 cu m (70 cu yd) per hr over an entire day. The average daily placement was about 382 cu m (500 cu yd) with a maximum of 554 cu m (724 cu yd). A total of 3,600 cu m (4,700 cu yd) of RCC was placed at a cost of \$100.24/cu m (\$76.64/cu yd), including materials and placement (Calvino 1993). The final RCC surface was covered with 457 mm (18 in.) of topsoil and seeded to provide protection from freezing and thawing and to make the dam blend with its surroundings (Figure 74).

### **Littlerock Dam**

Littlerock Dam is located on Littlerock Creek about 6.4 km (4 miles) south of the community of Littlerock in Angeles National Forest in northern Los Angeles County. The dam, which was completed in 1924, is a multiple-arch concrete structure with a maximum height of 51.8 m (170 ft) and a crest length of 219.5 m (720 ft). The main section of the dam has 24 arch bays with buttresses at 7.3-m

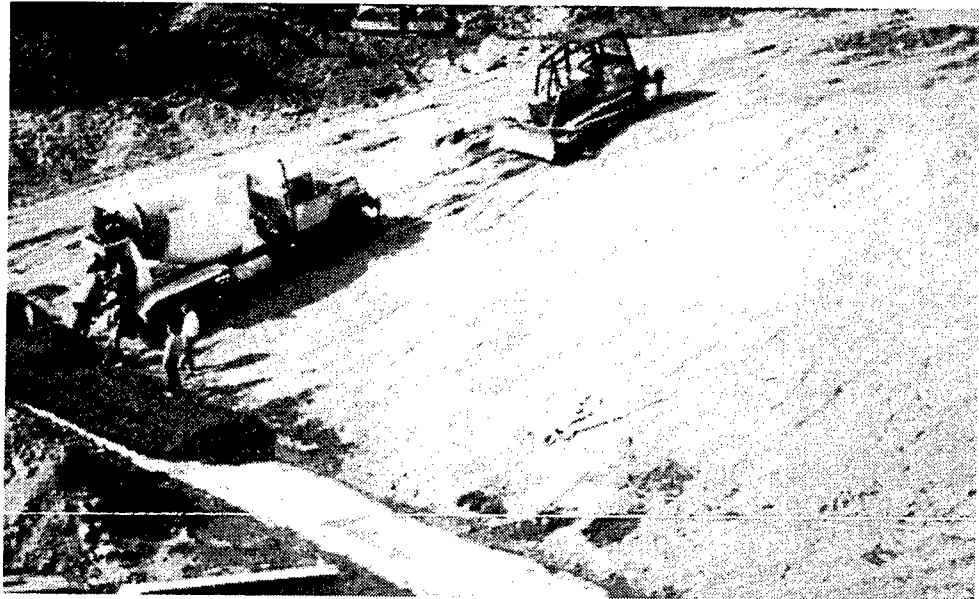

Figure 73. RCC being discharged from ready-mix truck onto left abutment at Rosebud Dam (courtesy of Calvino 1993)

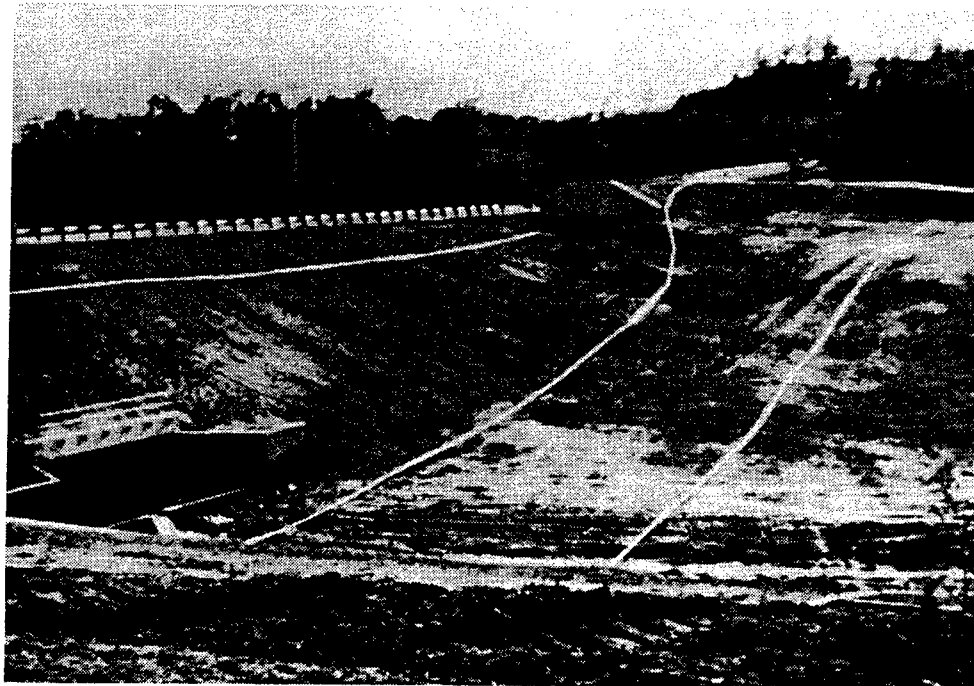

Figure 74. Seeded topsoil placed over RCC overtopping protection at Rosebud Dam (courtesy of Calvino 1993)

(24-ft) centers. The spillway, a 38.1-m- (125-ft-) wide ungated overflow section, was constructed in 1938 after the original spillway failed. The dam crest is at el 997 m (3,272 ft); the spillway crest is at el 993 m (3,258 ft). Originally the

reservoir had a storage capacity of 5,304,000 cu m (4,300 acre-ft), but siltation reduced the capacity to 2,714,000 cu m (2,200 acre-ft). Littlerock Creek Irrigation District and Palmdale Water District are joint owners of the dam.

Several studies concerning the design and overall stability and safety of the dam have been conducted since its construction. Of particular concern was its proximity to the San Andreas fault. In 1987, Woodward-Clyde Consultants (WCC) performed a geologic and engineering assessment of the dam and foundation. Basing their conclusions on a review of previous stability analyses, and on a preliminary reanalysis of the structure, the consultants concluded that the dam did not meet required seismic safety criteria, principally because of the lack of lateral stability inherent in most multiple-arch type structures (Bischoff and Obermeyer 1993).

Littlerock Dam is recognized as a historically significant structure because of its unique features. In order to satisfy tight preservation requirements and to provide adequate seismic stability of the dam, WCC developed an innovative rehabilitation design for the dam. The remedial design is described in detail by Wong, Forrest, and Lo (1993) and summarized in the following text.

Two alternatives for improving the lateral stability of the dam were considered. One alternative was to fill the arch bays between the buttresses with mass concrete. Estimated cost for this alternative was \$22.5 million. The second alternative, and the one adopted, was to use RCC to construct a gravity section between and around the downstream portions of the existing buttresses and to use shotcrete with steel fibers and silica fume to resurface and stiffen the existing arches. Estimated cost for this alternative was \$12.5 million, a savings of about \$10 million.

Preliminary stress and stability analyses, including a three-dimensional (3-D) model used to evaluate the composite structural scheme, indicated the arch barrels, wall buttresses, and RCC gravity section would maintain overall structural integrity and provide adequate margins of safety against sliding and overturning under all anticipated loading conditions. Some cracking would occur in the arch barrels but not in the wall buttresses or the RCC gravity section during an MCE.

An overview of the rehabilitation plan is shown in Figure 75. The nonoverflow section of the dam would be raised to a height of about 58 m (190 ft) (Figures 76 and 77). The spillway crest would be raised about 3.7 m (12 ft) (Figures 78 and 79), which would increase reservoir capacity to 4,317,000 cu m (3,500 acre-ft). The total volume of the buttress would be 90,220 cu m (118,000 cu yd), including 80,300 cu m (105,000 cu yd) of RCC.

Above el 960 m (3,150 ft), the downstream slope of the buttress would be 0.65H:1V formed in 0.6-m- (2-ft-) high steps. Below this elevation, the downstream slope would be 0.8H:1V and would be unformed. Conventional concrete facing would be placed on the downstream slope during construction. On the upstream face of the buttress in the maximum section of the dam, RCC

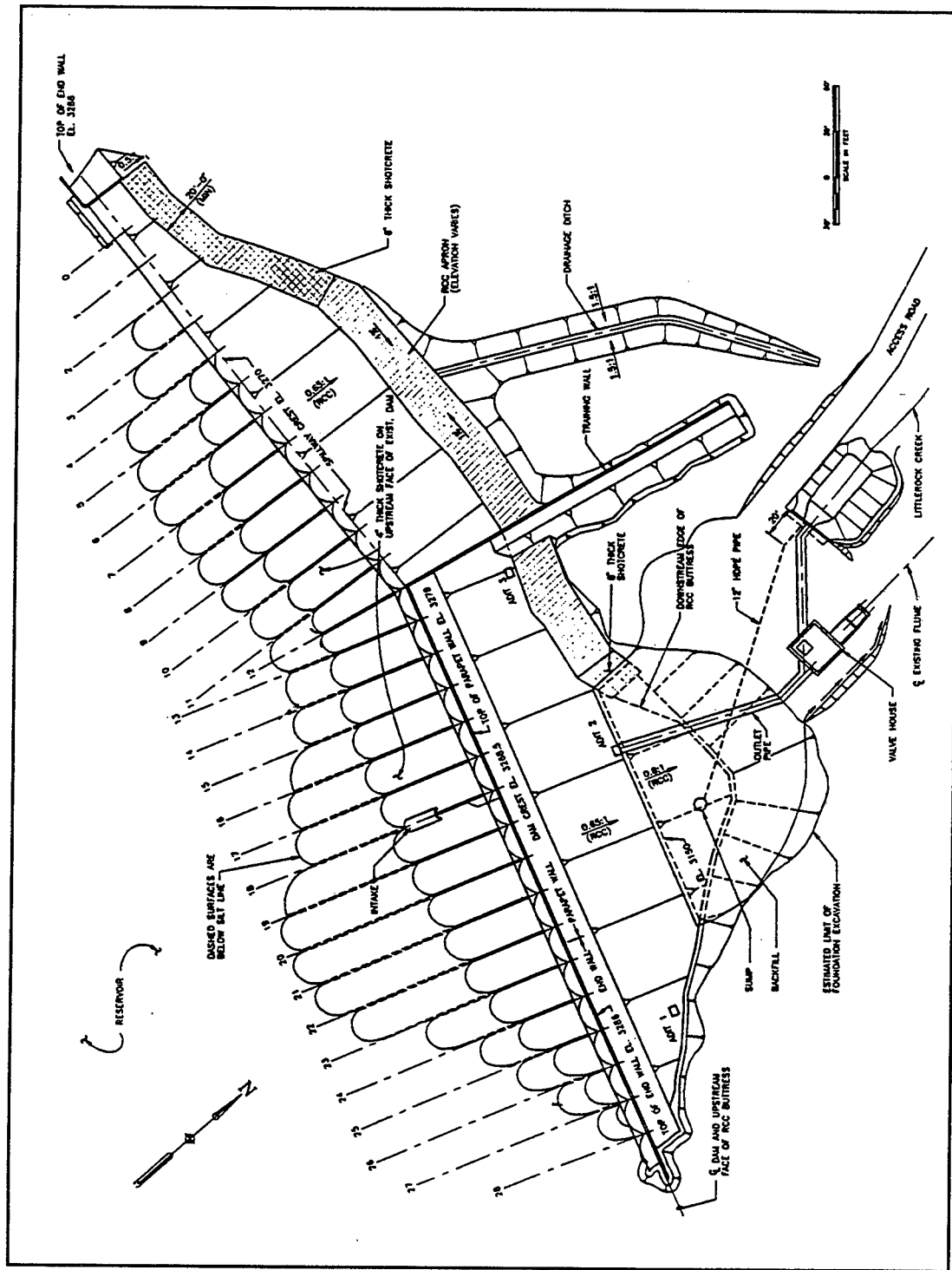

Figure 75. Rehabilitation plan for Littlerock Dam (courtesy of Wong, Forrest, and Lo 1993, ASDSO)

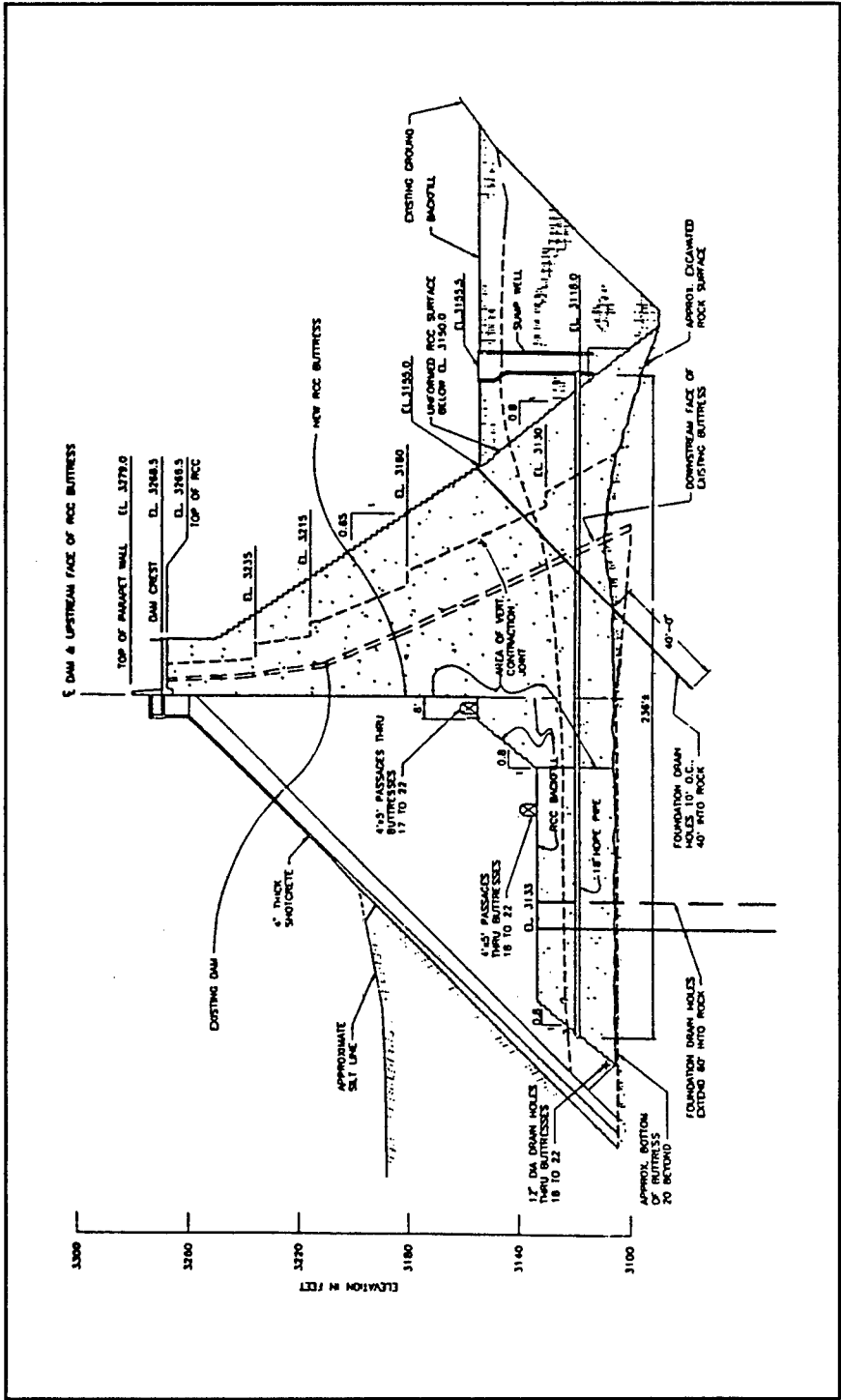

Figure 76. Cross section of maximum nonoverflow section, Littlerock Dam (courtesy of Wong, Forrest, and Lo 1993, ASDSO). (Multiply feet by 0.3048 to obtain metres and inches by 25.4 to obtain millimetres)

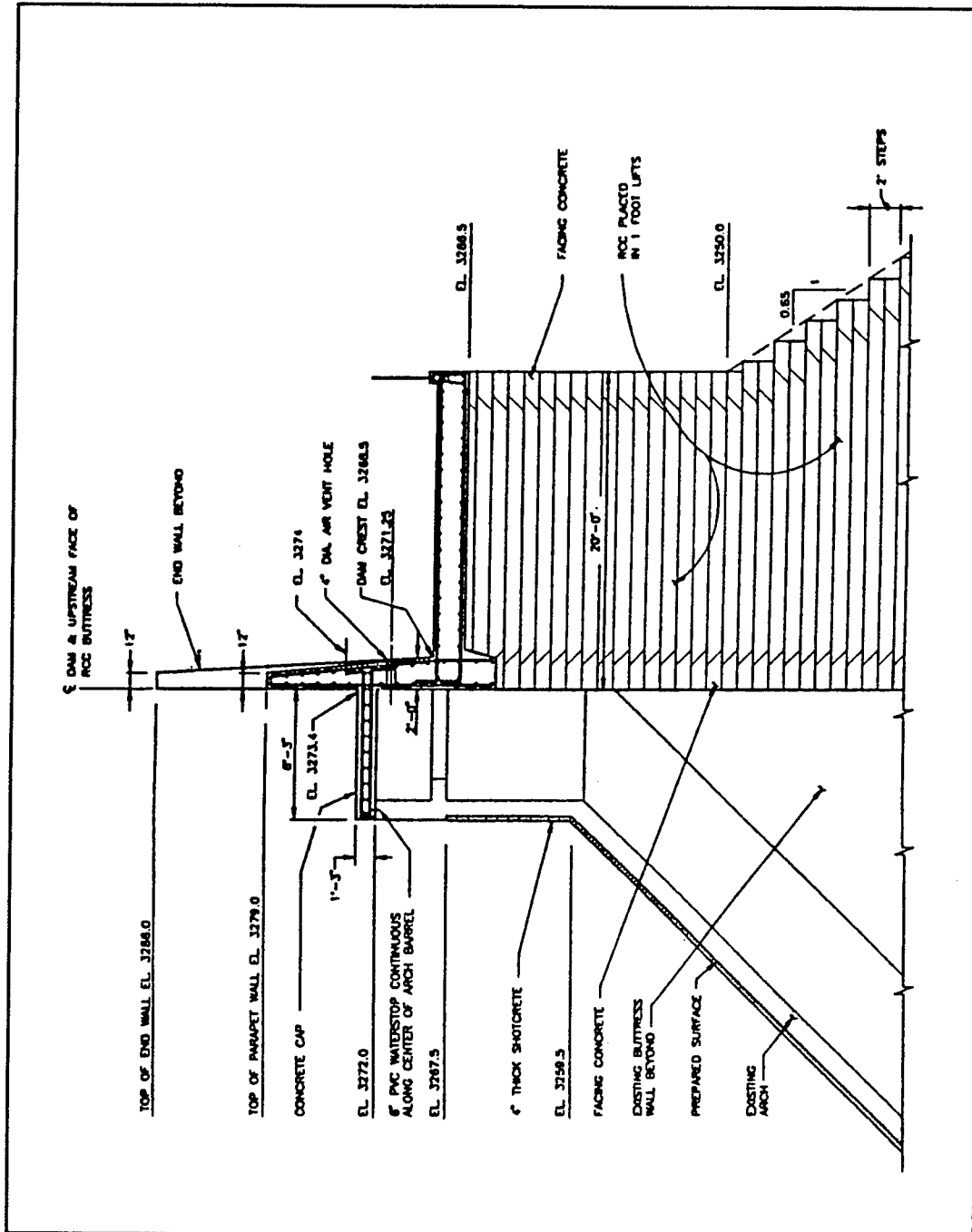

Figure 77. Crest detail, nonoverflow section, Littlerock Dam (courtesy of Wong, Forrest, and Lo 1993, ASDSO). (Multiply feet by 0.3048 to obtain metres and inches by 25.4 to obtain millimetres)

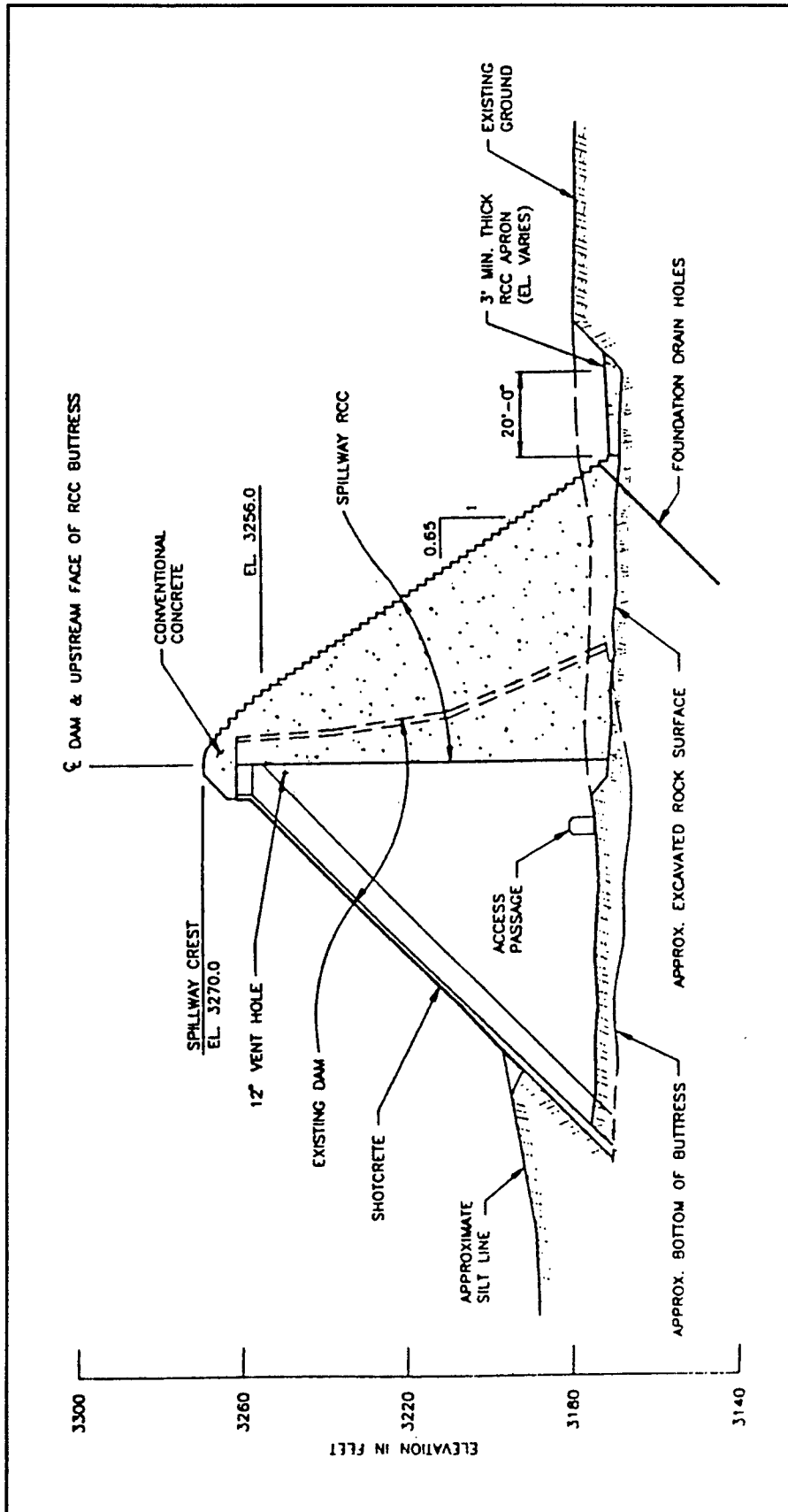

Figure 78. Spillway section, Littlerock Dam (courtesy of Wong, Forrest, and Lo 1993, ASDSO)

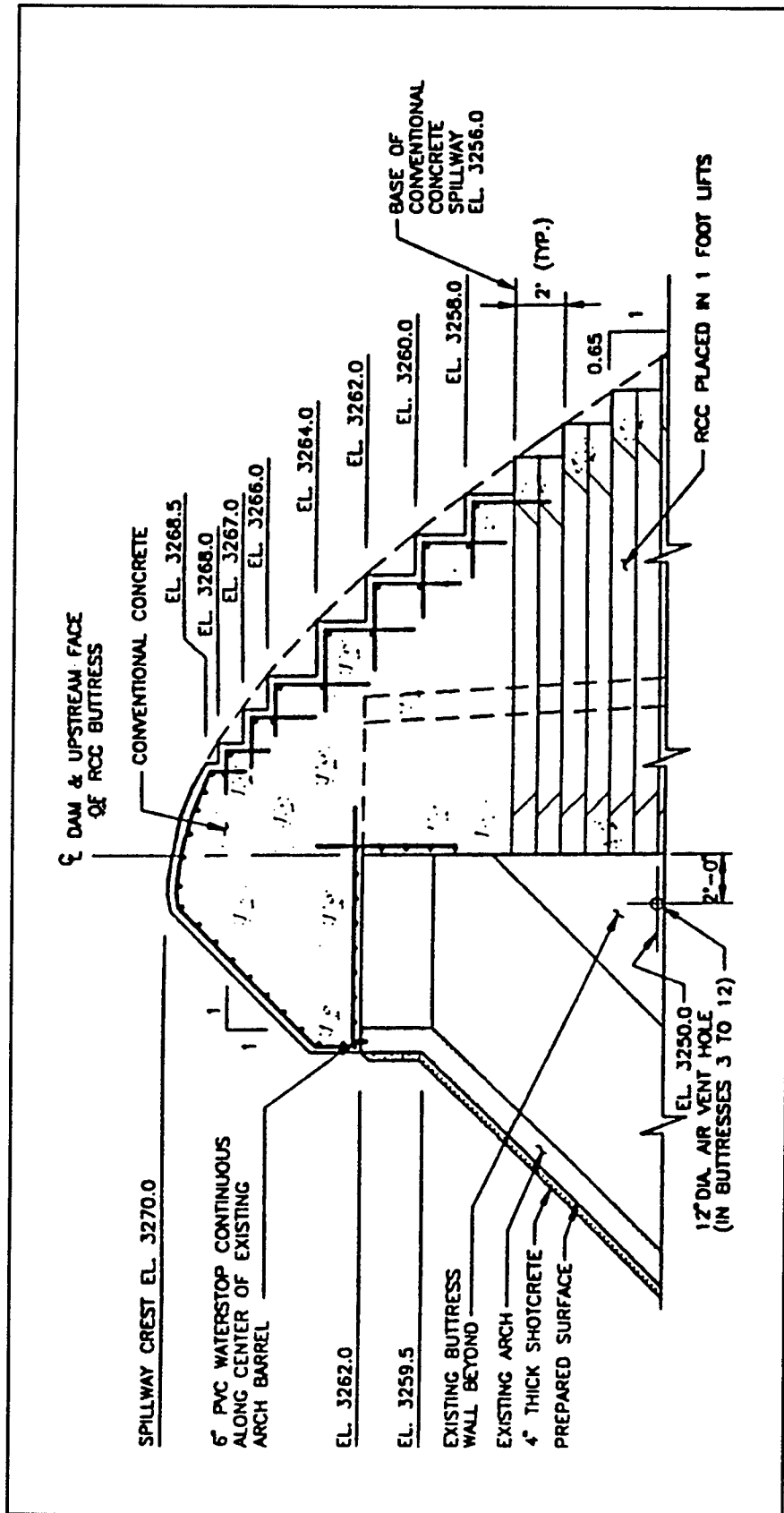

Figure 79. Spillway crest detail, Littlerock Dam (courtesy of Wong, Forrest, and Lo 1993, ASDSO). (Multiply feet by 0.3048 to obtain metres and inches by 25.4 to obtain millimetres)



would be placed to el 3,133 to reduce the effective height of the dam and to increase cross-channel seismic stability. Above the backfill, the upstream face of the RCC buttress would be vertical and would be faced with conventional concrete.

A 5.3-m- (17.5-ft-) high end wall constructed on top of the RCC buttress would prevent PMF reservoir water from overtopping the east end of the dam. A 3-m- (10-ft-) high, 76.2-m- (250-ft-) long cantilever parapet would be constructed between the end wall and the spillway. A concrete arch cap would be placed at the top of the existing dam to keep water from entering the bays, and training walls would separate the 96-m (315-ft-) long spillway section from the nonoverflow section.

Since the rock beyond the toe of the abutment slope downstream of the spillway showed no significant erosion, a stilling basin was not included in the rehabilitation plans. Instead, 6.1-m- (20-ft-) long RCC and shotcrete aprons would be constructed at the toe of the RCC to provide protection from potential erosion. One-meter- (3-ft-) thick portions of RCC would be placed in flat parts of the foundation. Shotcrete, 152-mm- (6-in.-) thick, would be placed on the abutments.

Prior to the start of construction, two RCC mixtures were tested in the laboratory to determine the proportions that would produce the design compressive strength of 15.9 MPa (2,300 psi) at 1 year. Test results indicated that a mixture with 89 kg/cu m (150 lb/cu yd) of Type II portland cement and 71.2 kg/cu m (120 lb/cu yd) of Class F fly ash would meet the requirement. To determine ultimate compressive strengths, a heated water bath was used for accelerated curing of the two RCC mixtures. The actual mixture proportions used were as follows:

<u>Material</u>	<u>Weight, kg/cu m (lb/cu yd)</u>
Portland cement, Type	65.3 (110)
Fly ash, Class F	97.9 (165)
Fine aggregate	787.9 (1,328)
Coarse aggregate	1,379.4 (2,325)
Water	112.7 (190)

The Vebe time for this mixture ranged from 15 to 20 sec.

Aggregate for the RCC was obtained from a local source. Maximum size was 38 mm (1-1/2 in.) with between 37 to 45 percent passing the No. 4 sieve and between 2 and 7 percent passing the No. 200 sieve.

Aggregate and sound concrete were exposed on the downstream surfaces of the existing buttresses to increase bond with the RCC. A conveyor carried concrete up from a batch plant at the base to a reversible belt at the crest where it dropped down a 610-mm- (24-in.-) diam baffled chute of high-density polyethylene (Figure 80). Front-end loaders transported the RCC to the

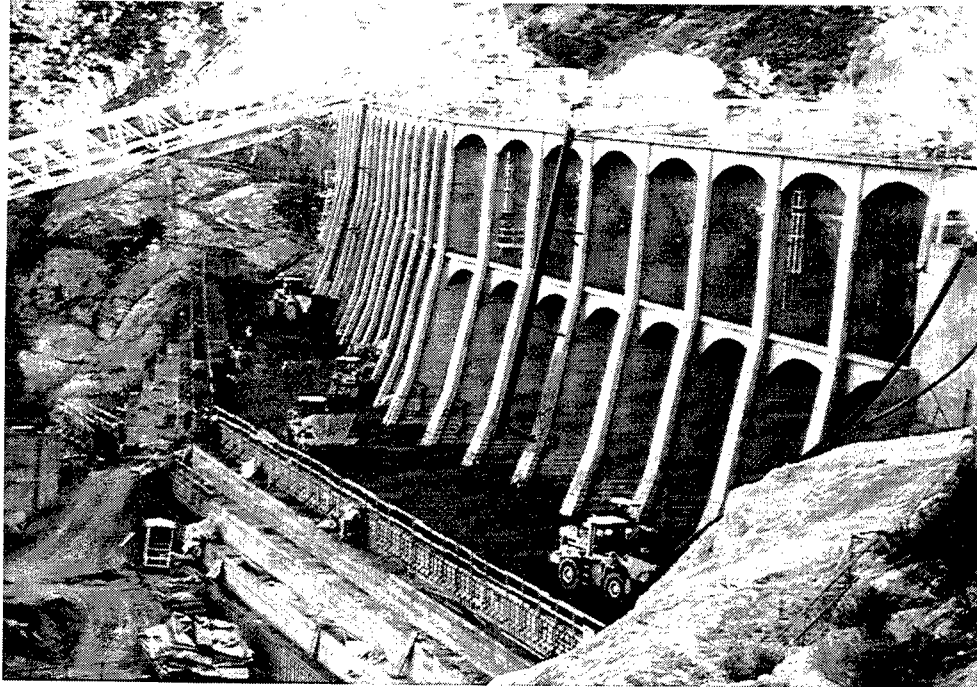

Figure 80. Concrete conveyor and discharge pipes, Littlerock Dam

placement site where it was then spread with dozers into 305-mm- (12-in.-) thick lifts and compacted with vibratory rollers (Figure 81). Specified compaction was an average wet density of 99 percent of the density of the laboratory test cylinders; 97 percent was the minimum acceptable density. Prior to placement of the RCC, a layer of bedding mortar was spread on the foundation rock surface. It was also placed between lifts of RCC to provide positive tensile strength between successive lifts in the event of an earthquake.

Contraction joints were located at the center of alternate bays (14.6-m (48-ft spacing)). Joints were constructed by vibrating steel plates into the RCC prior to compaction. The vertical joints, which act as crack inducers, extend horizontally from the upstream face into the RCC for distances that vary from 1.5 m (5 ft) at the crest of the RCC section to 7.6 m (25 ft) at the base. To discourage climbing on the downstream slope of the dam, the original 0.6-m- (2-ft-) high steps were replaced by 1.8-m- (6-ft-) high steps.

To provide for drainage and ventilation, passages were cut through the existing concrete buttresses, and a drain pipe extended from the upstream side of the RCC backfill to the downstream face of the RCC buttress to a sump well. Three 1.8- by 2.4-m (6- by 8-ft) adits constructed in the nonoverflow section of the RCC buttress provide access and ventilation. At the downstream toe of the RCC buttress, 12.2-m- (40-ft-) deep holes were drilled to help control foundation uplift pressures.

Instrumentation for monitoring the maximum section and the east end of the spillway included embedded thermocouples to measure temperature rise in the

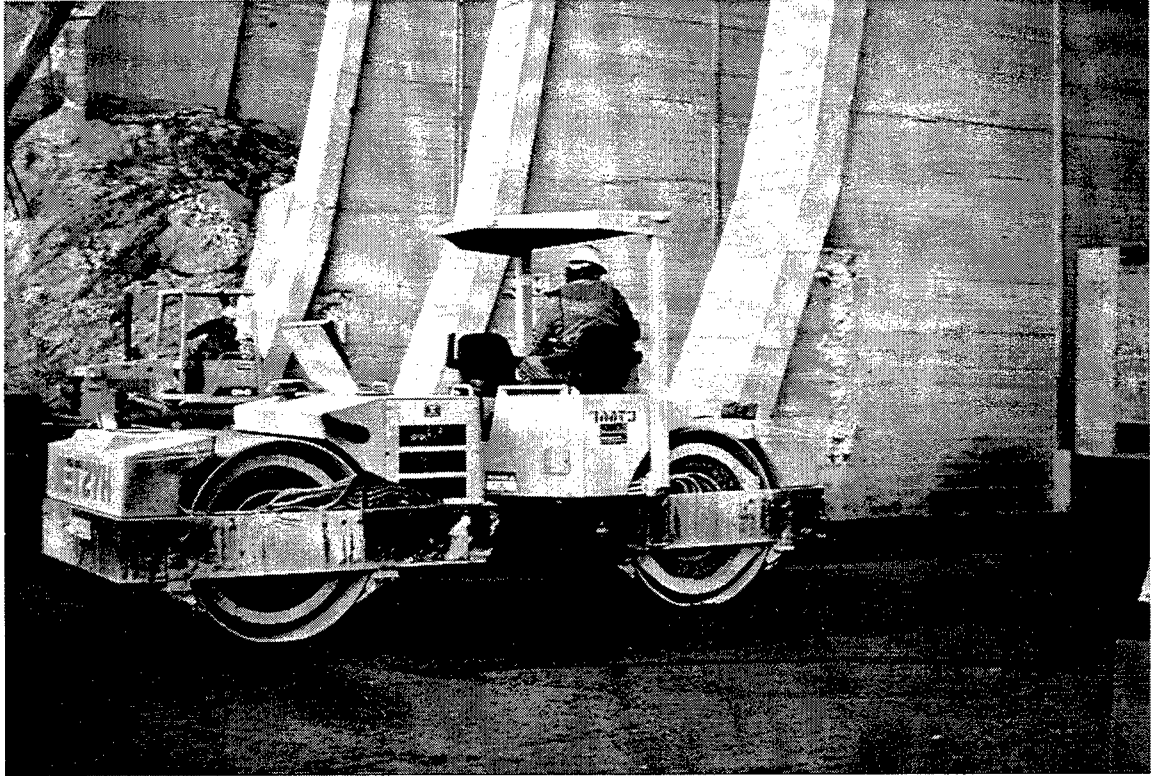

Figure 81. Compacting RCC around the existing buttresses, Littlerock Dam

RCC, crack detection meters at the interface of the RCC buttress and the existing buttresses and in contraction joints, survey monuments along the RCC crest, vibrating wire piezometers at the concrete-rock interface and in the foundation, and strong motion accelerographs at the base of the dam and at the crest of the maximum section.

Rehabilitation work began in May 1993 with excavation of earth within the bays. The contractor began placing RCC in late November and approximately 71,100 cu m (93,000 cu yd) were placed in just over 2 months. Total contract cost was approximately \$12.8 million.

In an update following the earthquake in the Los Angeles area in January 1994, *ENR* (1994) reported that Littlerock Dam suffered no damage as a result of the earthquake even though the epicenter was only 56 km (35 miles) from the dam. Some dams in the area suffered limited damage, but at the Littlerock Dam project, work was not even interrupted (Figure 82). The completed rehabilitation is shown in Figure 83.

### South Prong Dam

South Prong Dam was constructed in 1956 to supply water for the City of Waxahachie, TX. Located about 21 km (13 miles) southeast of the city, the dam is a 1,158-m- (3,800-ft-) long earth embankment with roadway embankment

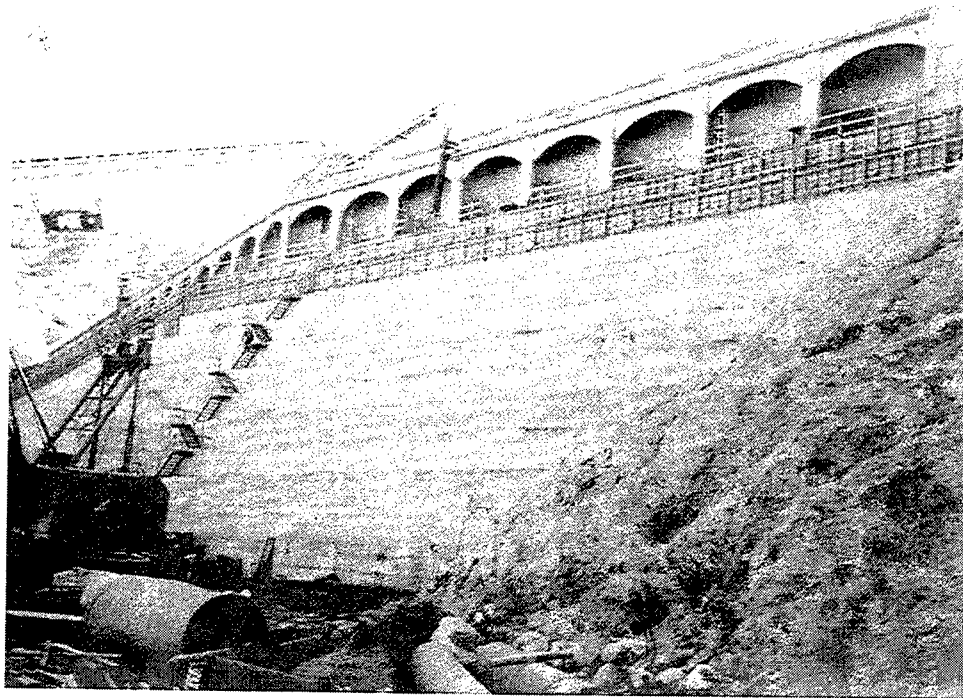

Figure 82. Partially completed rehabilitation of Littlerock Dam (courtesy of *ENR* 1994)

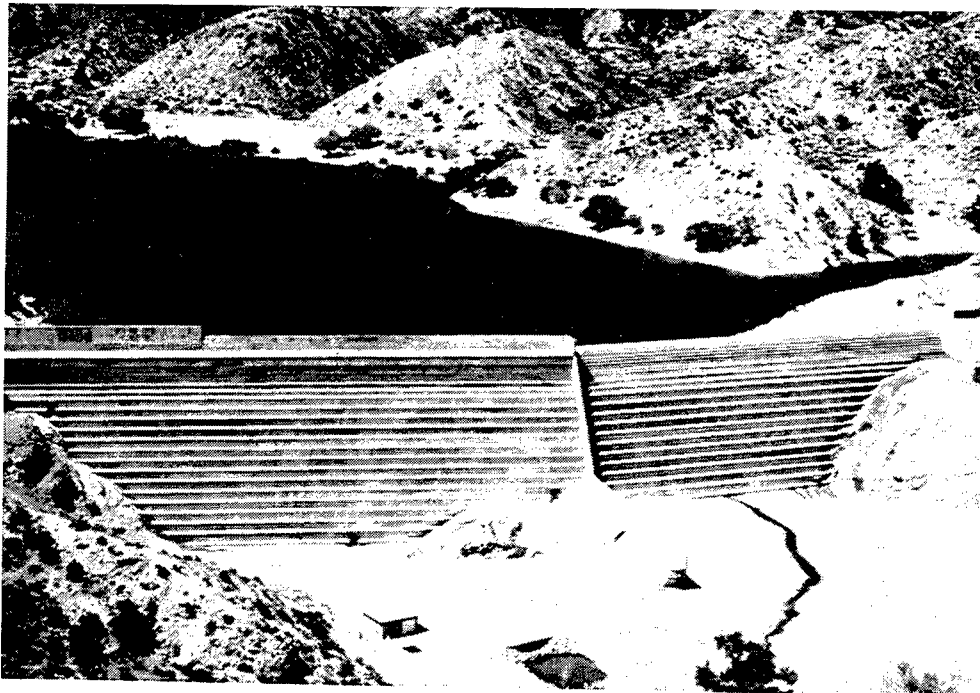

Figure 83. Downstream face of Littlerock Dam following rehabilitation

providing a berm at its toe. At normal pool level, 162 m (531.5 ft), the lake contains approximately 16,652,100 cu m (13,500 acre-ft) of water. A 91.4-m (300-ft-) wide, concrete, ogee-shaped service spillway is located at the south end

of the dam. A highway bridge crosses the approach channel to the spillway (Figure 84).

The Texas Natural Resources Conservation Commission (TNRCC) classified South Prong Dam as a high-hazard dam, because it could pass only about 50 percent of the PMF and because of its history of frequent surface slides on the downstream face of the dam during and after storms.

On occasion, the slides were as much as 2.7 m (9 ft) deep into the saturated clays of the slope. Repairs generally consisted of pushing the earth back into place with dozers but without compacting it. The process would have to be repeated after every rain storm. TNRCC set the dam's design flood as its full PMF and required that it be modified to comply with TNRCC regulations.

In August 1992, the City of Waxahachie retained a contracting company to study alternatives for modifying South Prong Dam that would both allow the dam to safely pass the full PMF and to prevent recurring sliding failures on the downstream slope of the embankment (Rutledge and King 1994). Options for increasing the discharge capacity included widening the service spillway and bridge, increasing the height of the dam with earth fill or a parapet wall, providing an armored emergency spillway in the middle of the dam, and various combinations of these options. Slide repair options included lime or cement treatment of the slopes, RCC or soil-cement overlays, flattening embankment slopes, and a toe berm.

Several of the options were too costly, and others required more space than was available; for example, the top of the dam could not be raised more than 0.9 m (3 ft), and there was no room along the slope for a berm. The modification selected for stabilizing the downstream slope was to flatten it to 4:1 and to reinforce the soil with fiber grids. The modification selected to enable the dam to pass the PMF was to construct an RCC-overlay emergency spillway (Figure 85) and increase the top elevation of the dam with a parapet.

The first step in implementing the emergency spillway plan was to decide where the spillway should be located. The spillway was to be 396.2 m (1,300 ft) long, and it had to discharge in a place that would not endanger life and property. The only place that met both criteria was along the tallest portion of the dam. The next step was the excavation configuration, which was set at 3 m (10 ft). The final step in the emergency spillway design was the RCC overlay and its subdrainage. Both placement and thickness of the RCC overlay had to be considered. Placement of the RCC would determine where cracks would form, and cracks could provide access for high-velocity overflow to the slab subgrade. The final decision was to place the RCC in horizontal lifts which would form a stepped profile up the slope of the spillway. If cracks should form parallel to the flow, they would be on the outer surfaces of the RCC and would cause little harm. If perpendicular cracks formed, they would be located near the toe of the steps, and the flow would not be directed at the cracks. An additional advantage of using a stepped profile was that the steps would help dissipate energy from spillway discharges, thus reducing potential uplift pressures. Therefore, the

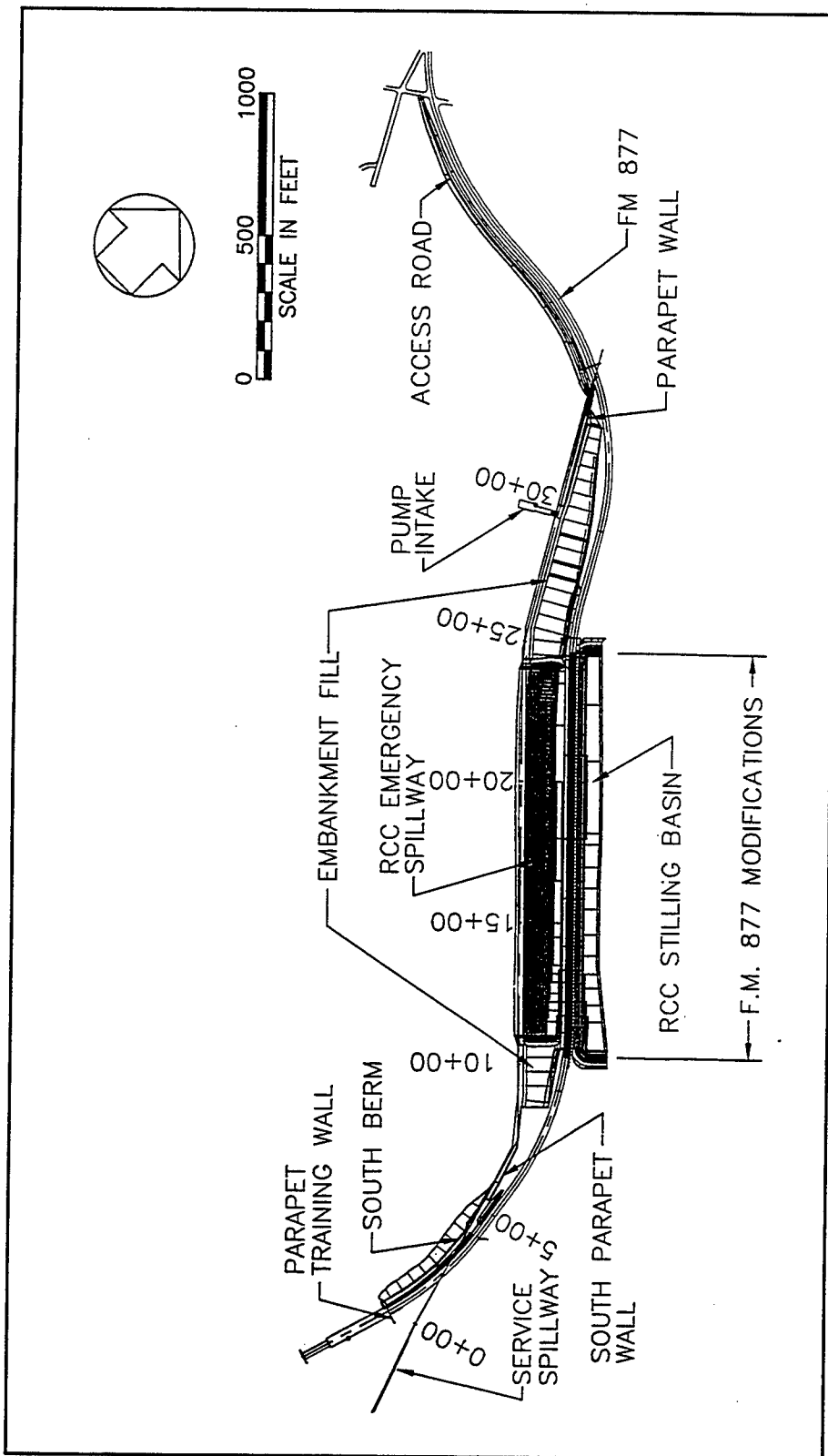

Figure 84. Layout of South Prong Dam. (Multiply feet by 0.3048 to obtain metres)

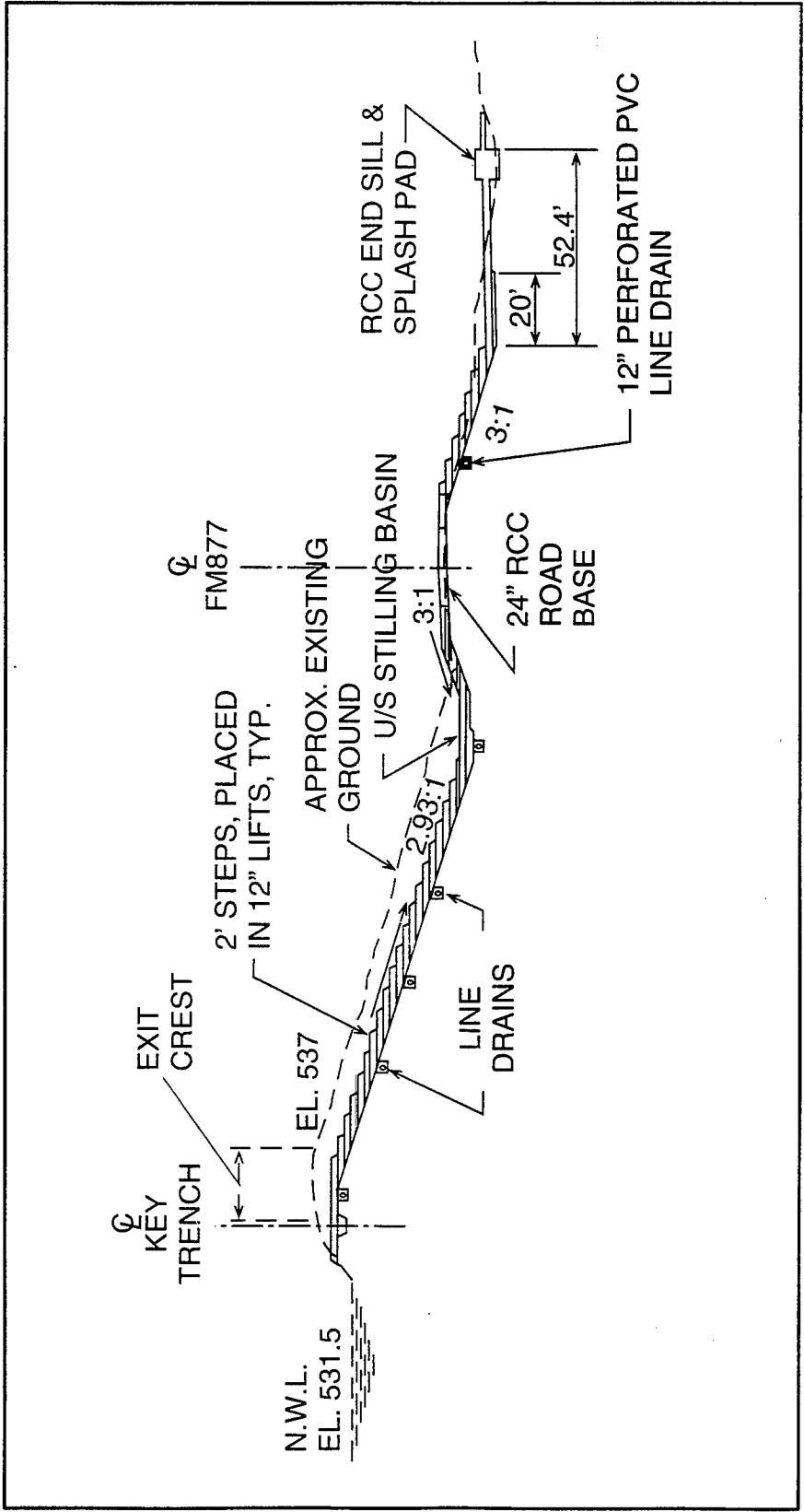

Figure 85. RCC emergency spillway, South Prong Dam. (Multiply inches by 25.4 to obtain millimetres and feet by 0.3048 to obtain metres)

thickness of the RCC overlay and the size of the stilling basin could be reduced (Rutledge and King 1994).

RCC construction at South Prong Dam began October 1994. The laboratory mixture of RCC consisted of 6 percent cement and 3 percent fly ash, based on the dry weight of the aggregate. It had a 28-day compressive strength of 13.8 MPa (2,000 psi). After initial field testing, a decision was made to eliminate the fly ash and use 7-1/2 percent cement to increase the compressive strength. Aggregate for the mixture was open pit run sandy gravel; 38 mm (1-1/2 in.) maximum size with approximately 5 percent passing the No. 200 sieve. Aggregate was screened at the batch plant to remove oversized material (Rutledge and King 1995).

Uplift pressures that can develop under a slab come from seepage through the dam or from under the slab from its interface with the lake and from discharges flowing into cracks. To help absorb uplift pressures and drain off seepage, six line drains were installed down the backslope of the spillway. Each drain was constructed with a 305-mm (12-in.) perforated PVC pipe placed in a 0.9- by 0.9- (3- by 3-ft) graveled trench that was wrapped in filter cloth.

With this drainage system, the RCC overlay perpendicular to the spillway slope had to be 0.9 m (3 ft) thick. To provide this thickness, 0.6-m (2-ft) horizontal steps were placed in 305-mm (12-in.) lifts. Precast concrete beams, lifted and placed with a crane, were used to form the downstream steps (Figure 86). Each beam was anchored to the previous step with reinforcing bars.

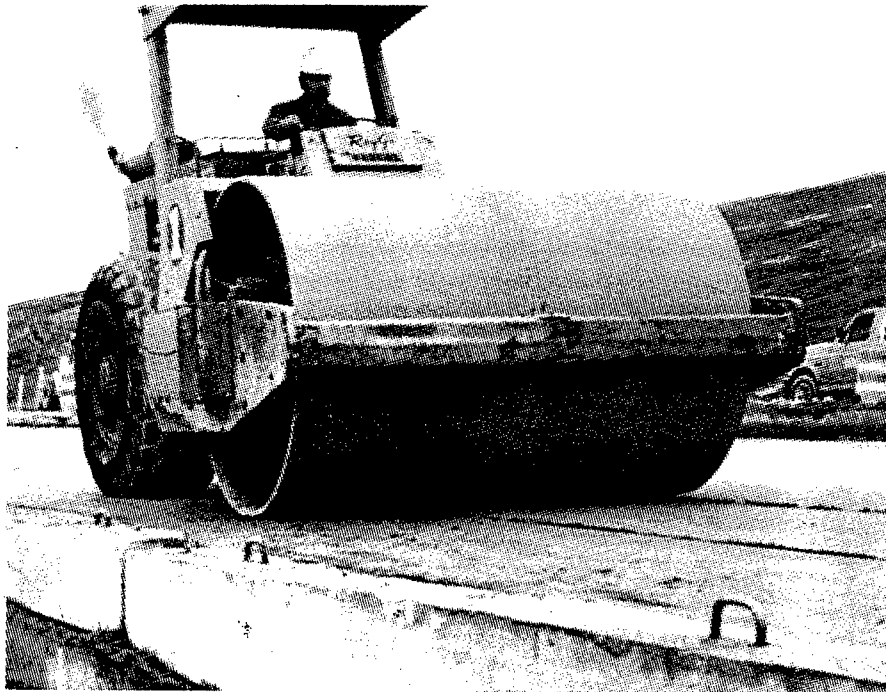

Figure 86. Precast concrete beams used to form downstream steps, South Prong Dam (courtesy of Rutledge and King 1995, Portland Cement Association)



This stepped profile matched the 2.9:1 subgrade slope and a 1:1 slope on the stepface.

The rehabilitation of South Prong Dam illustrates the effective use of RCC for overtopping protection and the use of fiber grids for reinforcement of weak clayey soil embankments. This project required approximately 39,760 cu m (52,000 cu yd) of RCC, the largest amount used on any RCC overtopping project in the U.S. to date. At a unit price of \$52.87/cu m (\$40.42/cu yd), RCC was more economical than a conventional concrete overlay, widening the service spillway, or increasing the height of the dam. RCC placement was completed by March 1995.

## Dam Replacement

RCC has been used for construction of new dams to replace rock-fill timber-crib, earth-fill embankment, and multiple-arch concrete dams. These replacements were necessitated by a variety of reasons, including deterioration, failure, and hydraulic deficiencies. Case histories for selected applications of RCC in dam replacement projects are summarized in Table 2 and described in the following text.

### Cedar Falls Dam

The Cedar Falls Project, which was constructed in the early 1900s, is located about 64 km (40 miles) southeast of Seattle, Washington, on the Cedar Falls River. Primary components of the original project were a masonry dam that impounds Masonry Pool, a timber-crib dam, which is located on Morse Lake, the powerhouse and power conduits. The project provides water, power, and flood control for Seattle (Figure 87).

In 1978, the U.S. Army Corps of Engineers inspected the project as part of the National Dam Inspection Act. As a result of this inspection, the Corps recommended that modifications be made at Cedar Falls Project so that it could safely pass the PMF. An additional problem that needed attention was seepage through the permeable soil that formed Masonry Pool. Steps would have to be taken to eliminate or minimize seepage-related stability problems and overtopping of the masonry dam. Therefore, the crib dam would have to be modified so that it could increase storage in Morse Lake, could regulate flow from Morse Lake, and could be overtopped or completely submerged. Of the alternatives evaluated, the one that best satisfied all requirements was construction of a new gravity dam with RCC (Bensen, Verigin, and Carney 1988).

One of the first factors to be considered was the foundation on which the gravity dam would be constructed. The northern half of Cedar Valley consists of sand and gravel deposits that are as deep as 183 m (600 ft) in places. This type of foundation can cause various problems for a gravity dam, including liquefaction,

**Table 2**  
**Summary of Dam Rehabilitation Case Studies**

RCC Completed	Name of Dam	Height, m (ft)	Length, m (ft)	RCC Volume, m <sup>3</sup> (yd <sup>3</sup> )	Cement + Fly Ash, kg/m <sup>3</sup> (lb/yd <sup>3</sup> )	Unit Cost, \$/m <sup>3</sup> (\$/yd <sup>3</sup> )	Application
1986	Cedar Falls	9.1 (30)	134.1 (440)	4,205 (5,500)	110 + 92 (185 + 155)	\$83.71 (\$64.00)	Replaced rock-fill timber-crib dam
1986	Dryden Left Bank & Right Bank	4.3 (14) 3.0 (10)	106.7 (350) 61.0 (200)	3,060 (4,000) 612 (800)	237 + 59 (400 + 100)	\$78.48 (\$60.00)	Replaced rock-fill timber-crib dams
1989	Marmot	16.8 (55)	59.4 (195)	7,870 (10,300)	71 + 107 (120 + 180)	\$73.25 (\$56.00)	Replaced rock-fill timber-crib dam
1990	Quail Creek South	24.4 (80)	610 (2,000)	134,940 (176,500)	80 + 53 (135 + 90)	\$23.90 (\$18.27)	Replaced fail earth fill
1991	Victoria	36.6 (120)	100.6 (330)	35,930 (47,000)	133 + 66 (225 + 112)		Replaced deteriorated concrete multiple arch-buttress dam
1992	Siegrist	39.6 (130)	213 (700)	64,990 (85,000)	53 + 42 (90 + 70)	\$50.36 (\$38.50)	Replaced earth-fill dam with inadequate spillway & reservoir capacity

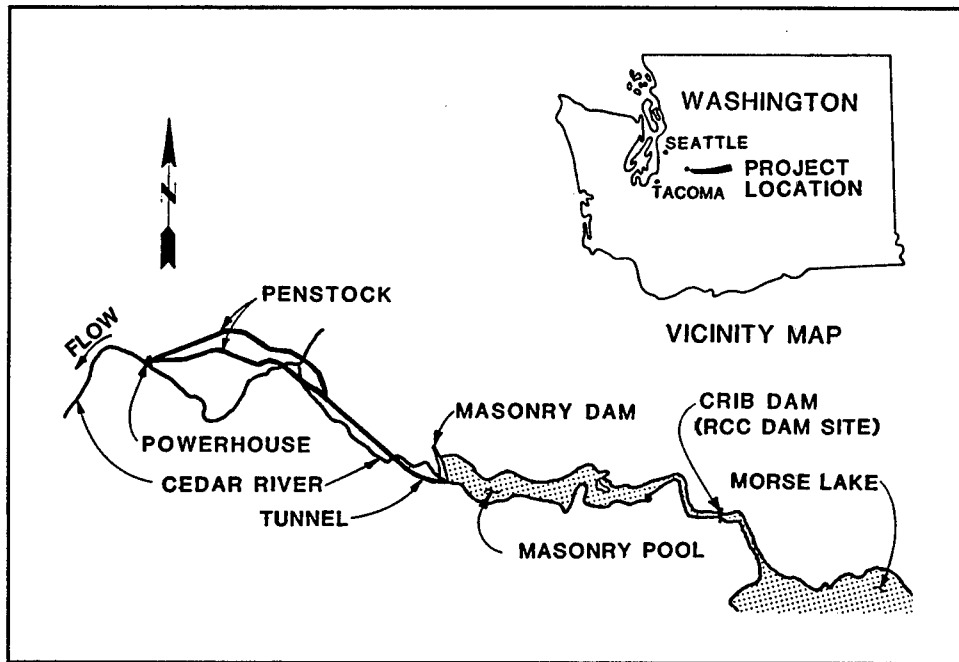

Figure 87. Layout of Cedar Falls Project (courtesy of Benson, Verigin, and Carney 1988, ASCE)

excessive settlement that would result in cracking, excessive foundation seepage, and piping of the foundation. The low-density soils in the upper 4.5 m (16 ft) of the foundation, which were thought to be exceptionally susceptible to liquefaction, were removed and replaced with earth fill. A filter/drain system was designed to collect seepage and control uplift and piping, and construction of a sheet-pile cutoff at the heel of the dam and a reinforced concrete apron upstream lengthened the overall seepage path (Figure 88) and helped control foundation seepage. Design and construction of the dam are described in detail by Benson and Hokenson (1988) and summarized in this case history.

Specifications called for the dam to be constructed in continuous lifts without construction joints. This method of placement caused concern that bending stresses would develop in the dam. A simplified finite element analysis was used as a conservative method of determining stresses during construction. The maximum tensile stress, calculated as 0.7 MPa (100 psi), was used as a basis for proportioning the RCC mixture.

At the time the gravity dam was constructed at Cedar Falls, no particular method of proportioning an RCC mixture existed; therefore, trial mixtures were prepared and tested with standard soil-testing and concrete-testing procedures. Criteria on which the final selection was made were the following: concrete strengths, durability, and workability; low temperature rise; and economics. The selected mixture proportions were 109.8 kg/cu m (185 lb/cu yd) of Type II cement and 92.0 kg/cu m (155 lb/cu yd) of Class F fly ash. Commercial aggregates that met ASTM C 33 (1975a) were obtained locally. Compressive

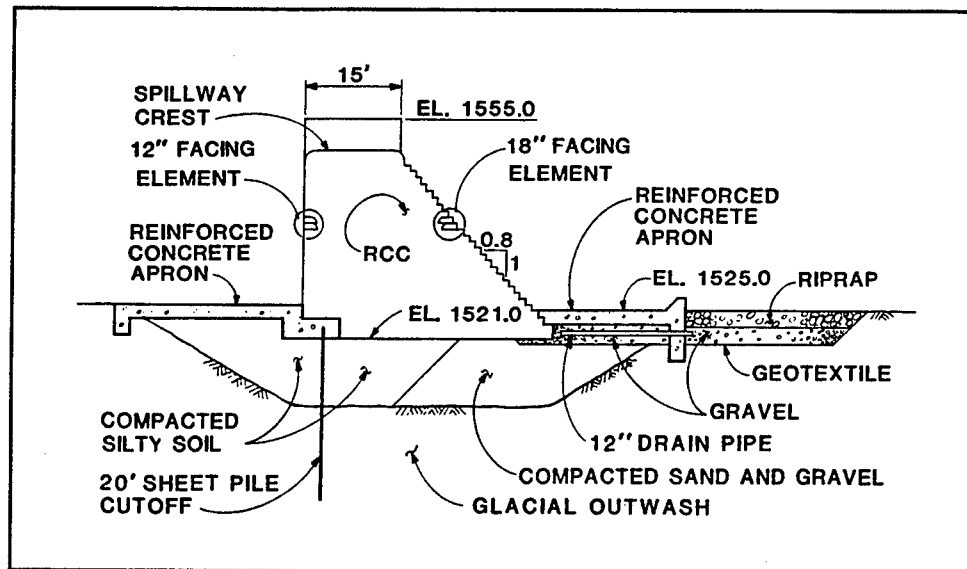

Figure 88. Cross section of RCC gravity dam constructed at Cedar Falls Project (courtesy of Benson, Verigin, and Carney 1988, ASCE). (Multiply inches by 25.4 to obtain millimetres and feet by 0.3048 to obtain metres)

strengths for the mixture were 15.2 MPa (2,200 psi) at 7 days and 22.1 MPa (3,200 psi) at 28 days.

Because two-thirds of Seattle's water supply comes from the Cedar Falls Project, the contractor had to work within physical and time restraints. The water had to be routed around construction, water quality had to be maintained, and normal flows could be interrupted for only 10 days. The contractor saved time and money by converting the old timber-crib dam into an upstream cofferdam. Before the RCC was placed, the upstream face was formed with wood sheeting; the downstream face, with timber and plywood forms. The forms on the downstream face were moved up as RCC was placed to form a stair-step pattern.

The RCC was mixed in a continuous-feed pugmill and deposited on a conveyor belt which delivered it to the construction site where it was spread with a small bulldozer or front-end loader. It was compacted with a 9,070-kg (10-ton), smooth drum vibratory roller. Small vibratory rollers were used for confined areas. From two to four lifts were placed each day. The contractor's goal was to prevent buildup of excessive heat by allowing some cooling time between lift but to keep the lift surfaces bondable. Construction joints between lifts were classified as needing treatment if placement of successive lifts exceeded 311.1 deg C-hr (560 deg F-hr) or if placement occurred in less than 72 hr. Lift joints required a 1-in. thickness of bedding concrete before the subsequent lift was placed. If placement was delayed beyond 72 hr., the lift joint surface had to be cleaned before the bedding concrete was spread.

Approximately 4,200 cu m (5,500 cu yd) of RCC was placed between 19 September and 2 October 1986. Cost of the RCC, including cement and fly ash,

was \$83.71/cu m (\$64.00/cu yd), considerably less than the estimated \$115 to \$153/cu m (\$150 to \$200/cu yd) for conventional cast-in-place concrete. The Cedar Falls Project demonstrated that RCC can be used successfully at sites with soil foundations. The design for a gravity dam with a soil foundation should incorporate a means of controlling seepage and hydraulic gradients to prevent piping of the foundation and allowance for foundation settlement that would prevent excessive cracking in the dam.

## **Dryden Dam**

Dryden Dam, which actually consists of two dams separated by a small island, is located on the Wenatchee River approximately 32 km (20 miles) upstream of Wenatchee, WA. The dams were constructed in the early 1900s to divert irrigation water to a side channel. The original dams were rock-fill timber-crib structures. Maintenance was continual as the dams were frequently damaged by overtopping, debris, and ice, all of which caused the timbers to deteriorate. Public Utility District No. 1 of Chelan County owns and operates the dams. In 1986, the utility decided to rehabilitate or replace the dams in conjunction with the construction of two new fish ladders at this location. Design and construction of the dam is described in detail by Green (1991); this case history is a summary of his report.

Preliminary studies indicated that (a) alternatives for improving the existing structures were undesirable for a number of reasons, (b) the alternative of replacement with conventional concrete dams would exceed the available budget, and (c) RCC dams would function very well for the intended purpose. Although the cost for RCC was difficult to estimate because of the lack of contractor experience in bidding such a small-scale project, results of the study indicated that even the highest estimated unit cost for RCC would be less than the lowest estimated unit cost for conventional concrete.

The first step was to determine the materials proportions that would produce an RCC mixture that was workable, that could be compacted to specification, and that would be durable. The aggregate available onsite could not be used without extensive processing, so aggregate for the project was obtained from a local source. Specifications called for an aggregate produced from hard, durable rock with a maximum size between 25 to 38 mm (1 to 1-1/2 in.), a minimum of 5 to 10 percent fines and a maximum of 15 to 20 percent, and enough sand-sized material in the matrix to help control segregation. Class F fly ash was selected for increased durability and long-term strength gain, lower permeability, and better workability and compaction. The mixture was to contain sufficient cementitious material to yield durable, wear-resistant concrete. The amount of water used would vary during construction but was to be sufficient to produce a mixture ranging from optimum to slightly wet of optimum moisture as determined by standard soil compaction procedures. The basic philosophy adopted for the project was that RCC should be treated as a processed soil from the proportioning stage through placement and field testing, and then it should be cured and treated like conventional concrete.

Because the RCC would be exposed to weathering and erosion, a mixture with a high cementitious content and high density was desirable. Previous experience with concrete under similar exposure conditions indicated that a compressive strength between 17.2 to 24.1 MPa (2,500 to 3,500 psi) was desirable. Several mixtures were tested in the laboratory. Samples were compacted in test cylinders, removed and cured in a moist room, capped and tested for compressive strength (Figure 89), according to ASTM testing procedures. Inconsistent moisture readings during testing were determined to be caused by the water being used in the hydration of the cement and the difficulty of getting accurate moisture contents for oven dry samples. A decision was made to use wet density for control purposes instead of dry density. The selected mixture proportions were as follows:

Material	Weight, kg/cu m (lb/cu yd)
Portland cement	237.3 (400)
Fly ash, Class F	59.3 (100)
Aggregate	2,046.9 (3,450)
Water	112.7 (190)

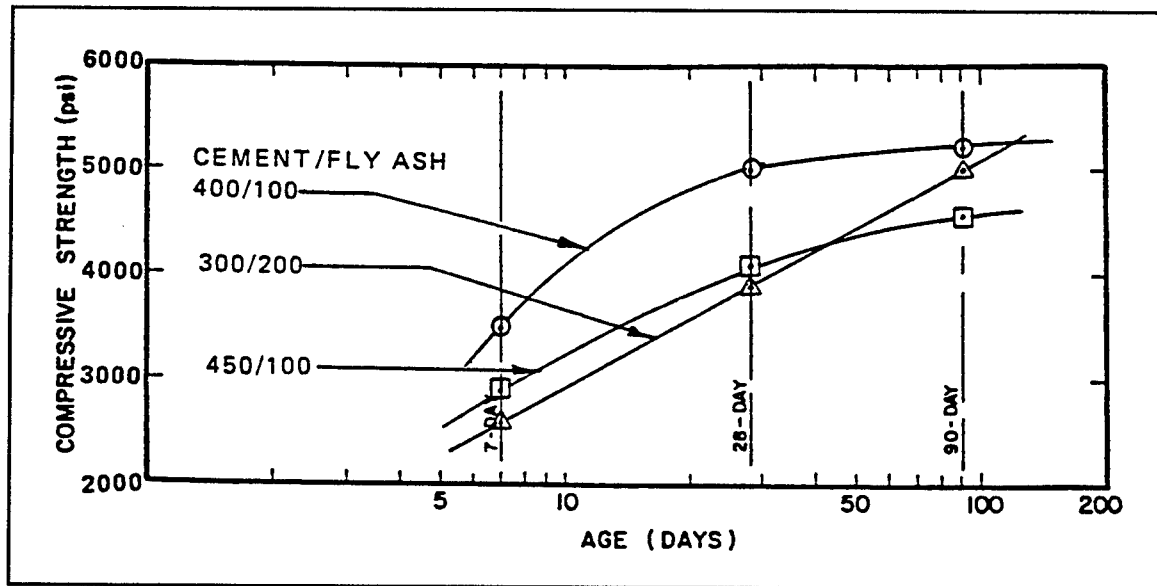

Figure 89. Results of compressive strength tests on laboratory-compacted RCC cylinders for Dryden Dam. (Multiply pounds per square inch by 0.006894757 to obtain megapascals)

The owner had reserved the option of constructing only one dam depending on bid prices. However, the total cost of construction was within the allotted budget and both dams were constructed. The Right Bank Dam was about 61 m (200 ft) in length, varied in height from 2.1 to 3.4 m (7 to 11 ft), and contained approximately 612 cu m (800 cu yd) of RCC (Figure 90). The Left Bank Dam was about 99 m (325 ft) long, varied in height from 3.4 to 5.2 m (11 to 17 ft), and

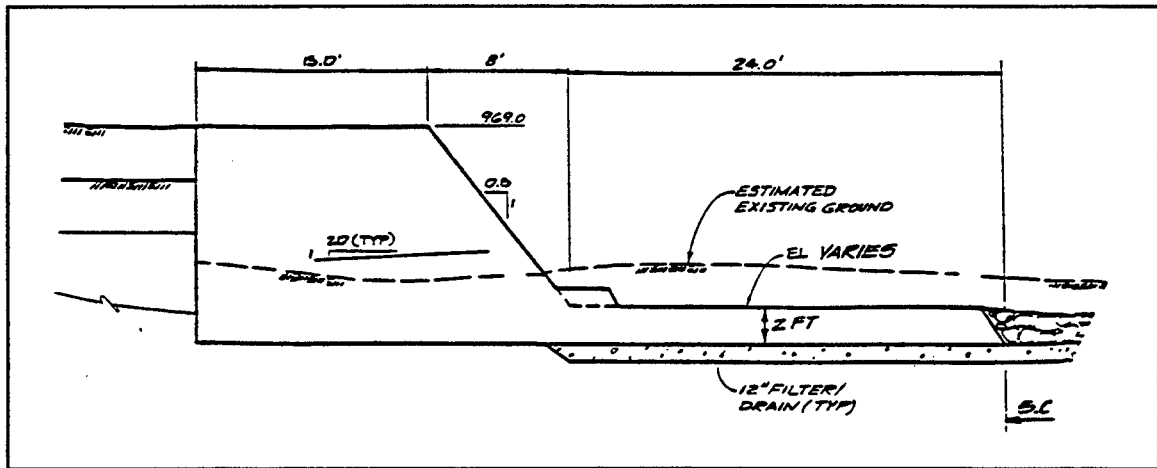

Figure 90. Typical cross section, Dryden Dam (courtesy of Green 1991, Portland Cement Association)

contained approximately 3,060 cu m (4,000 cu yd) of RCC. As required by fisheries agencies, this dam contained a 30.5-m (100-ft) length with the cross section shown in Figure 91. The vertical face causes water to spill beyond the edge of the concrete so that when fish attempt to jump into the flow, they fall through the nappe into a pool of water rather than onto a sloped concrete surface beneath.

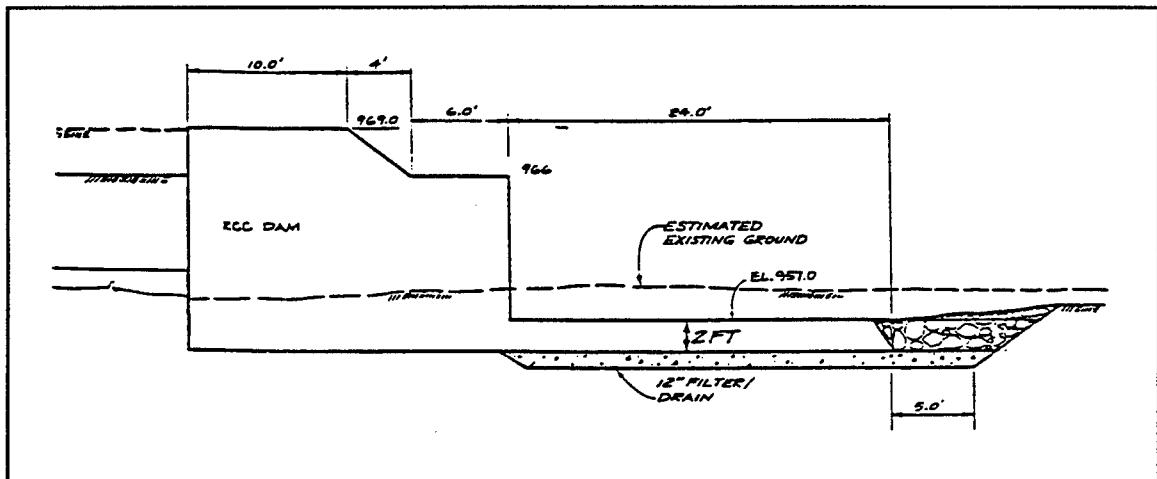

Figure 91. Barrier cross section, Dryden Dam (courtesy of from Green 1991, Portland Cement Association)

A pugmill used for mixing the RCC was designed to feed two aggregate materials, water, and cement into the drum. Although an additional silo could have been added to feed the fly ash, the contractor elected not to add one because of the difficulty of locating the proper feed mechanism and the cost of setting it up. Instead, he requested permission to use Type IP cement and a coarse grade of fly ash which would be blended with the cement and interground to the required

fineness at the cement plant. Samples of the blended cement and fly ash were used to make RCC samples for further laboratory testing. Test results were virtually the same as those of previous tests; therefore, the contractor was allowed to use the combined cementitious material.

Because of the uniform gradation of the material and accurate control at the pugmill, the RCC was very consistent throughout the project. The moisture requirement varied slightly between the day and night shifts because of more drying of the material during the day. Segregation was not a major problem during placement as long as reasonable care was used in handling the RCC. Segregation that occurred when the material was loaded into the dump trucks was controlled by remixing the material with the spreading equipment and by careful placement of the RCC. The specified maximum lift thickness before compaction of 305 mm (12 in.) appears to be about the maximum desirable thickness. Densification of 97 to 99 percent relative compaction was obtained with this depth but only after many passes with a vibratory compactor. Very good compaction was obtained in the top 203 to 254 mm (8 to 10 in.) with significantly fewer passes.

Constructing the downstream face of the dams to the specified slope of 0.8H:1V was difficult. The first dam was overbuilt and compaction was not uniform in the overbuilt areas because workers did not know how to achieve the specified angle on the slope. It is expected that over time these areas will erode down to the densely compacted concrete. Workers had better control on the second dam after learning how to overcome some of their problems. One means of controlling the construction of the slopes was to use a survey crew at all times. Each lift had to be slope staked to provide a guideline for the equipment operator. To obtain compaction on the outer edge of the lift, the contractor used rubber-tired equipment to wheel-roll the edge. By positioning the wheel slightly over the edge of the slope, workers were able to compact the edge of the lift and force the RCC over the edge to form a slightly steeper slope angle.

An approximately 0.9-m- (3-ft-) wide section of bedding mixture was placed between each lift near the upstream side of the dam to improve bond between lifts and control potential seepage through the dam. In addition, a silty, sandy gravel backfill was placed against the upstream side of the dam. By migrating to any seepage paths that might exist, the sand and silt could act as a natural barrier to water seepage through the dam.

Drying of the RCC during hauling, placement, and spreading was another concern. Working as fast as practical was one way of controlling drying. Also, a full-time worker sprayed the RCC surface with water throughout construction, and when construction was completed, a sprinkler system was installed to water cure the concrete.

Field tests were conducted throughout construction. Wet densities ranged from 2,291 to 2,384 kg/cu m (143.0 to 148.8 lb/cu ft) with an average for 64 tests of 2,332 kg/cu m (145.6 lb/cu ft). This average represents a relative compaction of 97 percent based on maximum dry density at optimum moisture content. Field



moisture content averaged about 6-1/2 percent throughout construction. An automated soil compaction machine was used to compact 152- by 305-mm (6- by 12-in.) test cylinders in the field. Cylinders were held in a water bath curing tank until they could be moved to the laboratory moist room at the end of RCC construction. The temperature of the water in the curing tank was approximately 13 deg C (55 deg F); therefore, the results of these tests may be lower than they should be. The cylinders were tested at 28 or 90 days (Figure 92).

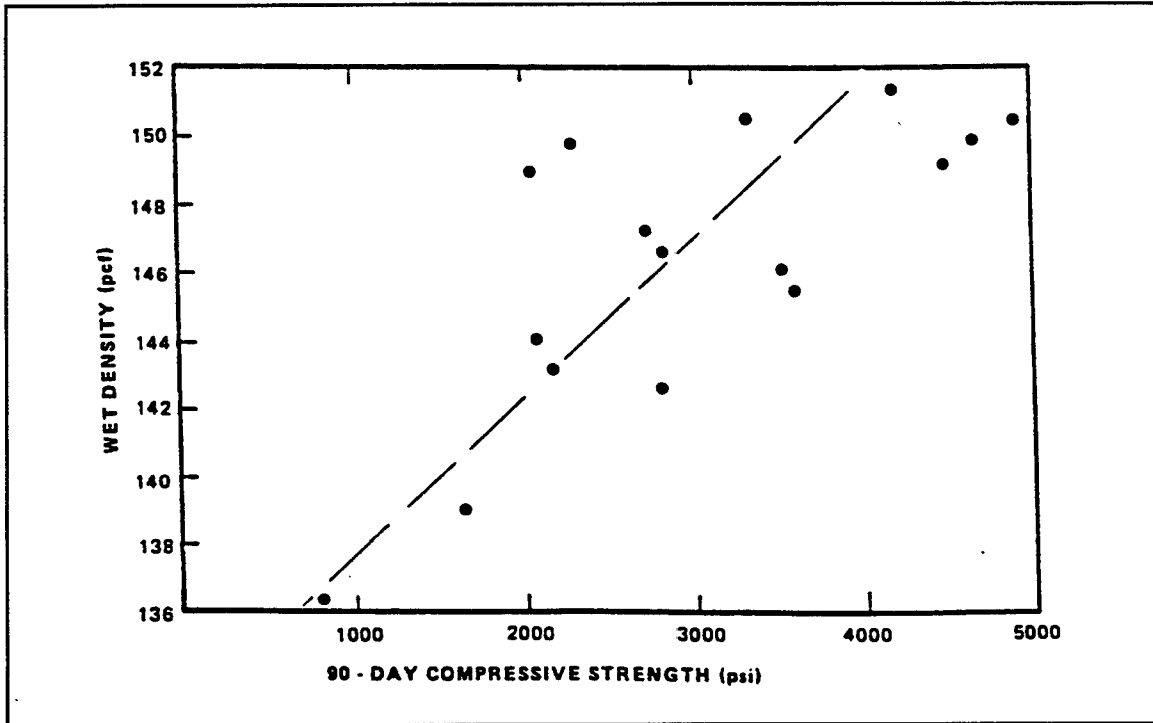

Figure 92. Results of compressive strength tests on field-compacted RCC cylinders, Dryden Dam

The Right Bank Dam required 612 cu m (800 cu yd) of RCC, which was placed in 24 hr. The Left Bank Dam required approximately 3,060 cu m (4,000 cu yd) of RCC which was placed in 46 hr. Costs of the RCC for this project were estimated to range from about \$52 to \$76/cu m (\$40 to \$100/cu yd). The contractor's actual bid price was approximately \$78/cu m (\$60/cu yd) for furnishing, mixing, and placing the RCC.

### Marmot Dam

Marmot Dam, located on Sandy River approximately 30 miles east of Portland, OR, was completed in 1913. The rock-fill, timber-crib dam was constructed by Portland General Electric (PGE) as part of the Bull Run hydroelectric project. Its purpose was to divert water to the electric company's powerhouse. The dam was 152.m (50 ft) long and 59.4 m (195 ft) high with a vertical upstream face and an 0.8:1 sloping downstream face. An intake structure

for the powerhouse was located on the right abutment and a fish ladder, along the left abutment (Benson and Pavone 1993).

Over time the reservoir behind the dam became infilled with sediment, and the dam began to settle. Although repairs were made, the dam continued to settle, and in the summer of 1987 a sink hole was observed in the sediment upstream of the dam. This discovery led to a full-scale inspection of the dam. In 1988, the reservoir was dewatered and the sediment excavated to expose the upstream face. The inspection revealed the crib dam had lost its structural integrity and that the primary water-retaining structure at the site was the sediment "dam" upstream of the crib dam (Benson and Pavone 1993).

Following the inspection, a study was conducted to determine the best method for replacing the dam. Alternatives submitted to PGE were to construct (a) an RCC dam with a conventional concrete facing, (b) a conventional concrete gravity dam, (c) a conventional concrete gravity dam with foundation tendons, and (d) a new timber-crib dam. The alternative selected was the RCC dam (Figure 93). The decision to use RCC was based on several factors: RCC would allow rapid placement; the RCC core with air-entrained conventional concrete facing on exposed surfaces would provide water tightness and long-term durability; RCC would be less vulnerable to damage should overtopping occur before completion; and RCC was economical. The replacement dam, which was to be constructed along the same axis as the original dam, was to have a maximum height of 16.8 m (55 ft) and crest length of 59.4 m (195 ft) with an uncontrolled ogee spillway (Benson and Pavone 1993).

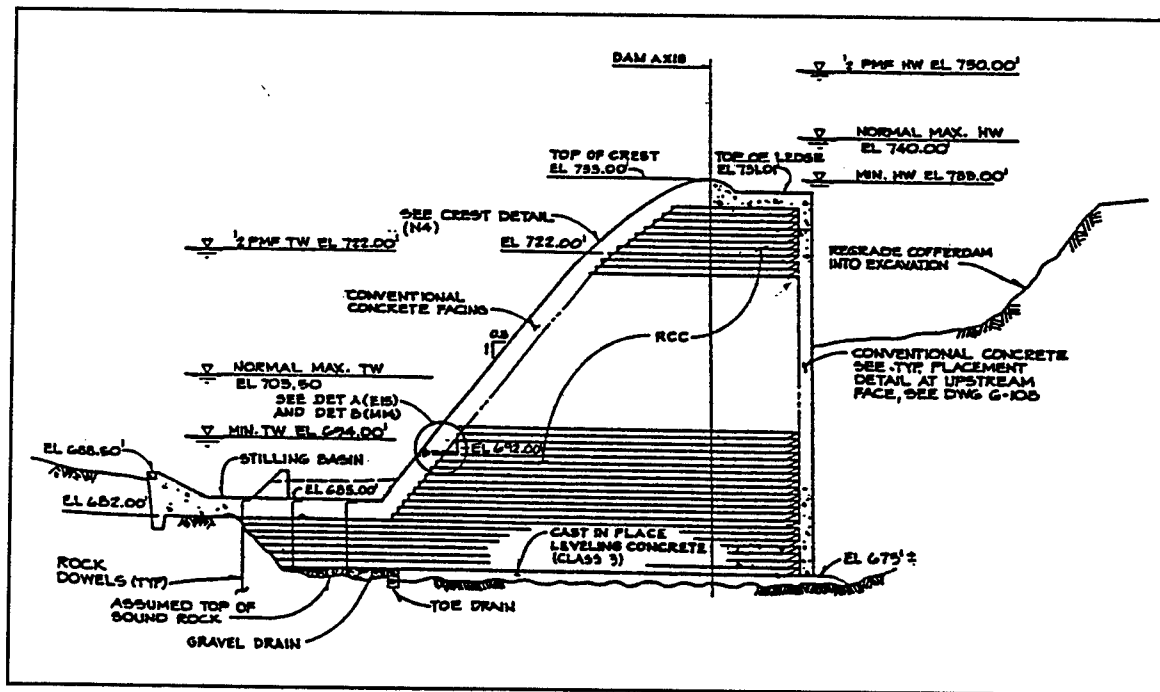

Figure 93. Typical section, Marmot Dam (courtesy of Benson and Pavone 1993, ASDSO)

The contract for the new dam called for minimum interruption of fish runs and continued operation of the company's hydroelectric power plant, with no reduction in capacity; therefore, construction was scheduled for July through September, the period of lowest flow for the river (*RCC Newsletter* 1989a).

The RCC mixture used in the project was first tested in the laboratory. Three sets of five trial mixtures of RCC were prepared, with each set representing a different fine aggregate source. Aggregate was obtained from commercial sources. Vebe times were recorded for each mixture and test cylinders were prepared for compressive strength testing (Sert 1993). Specifications called for an RCC mixture that would achieve a 1-yr minimum compressive strength of 13.8 MPa (2,000 psi), contain sufficient paste to fill voids and coat all aggregate surfaces, contain sufficient water for consolidation, and have a Vebe time of 10 sec, based on a Vebe test with a 19-kg (42-lb) surcharge. The mixture proportion selected were as follows:

Material	Weight, kg/cu m (lb/cu yd)
Portland cement	72.3 (120)
Fly ash	106.8 (180)
Fine aggregate	753.5 (1,270)
Coarse aggregate, 38 mm (1-1/2 in.)	741.6 (1,250)
Coarse aggregate, 76 mm (3 in.)	504.3 (850)
Water	103.8 (175)

The mixture also contained a set-retarding, water-reducing admixture (*RCC Newsletter* 1981a).

Before beginning the actual construction on the dam, the contractor placed the RCC in a 15.2- by 15.2-m (50- by 50-ft) test fill. A 1.5-m (5-ft-) high vertical form was erected on one side of the test area to simulate the upstream vertical face. Performing the test fill enabled the contractor to check the equipment, the placement procedure, and to establish a relationship between Vebe times and densities. Densities for the test fill averaged 2,451 kg/cu m (153.0 lb/cu ft); the target density was 2,403 kg/cu m (150.0 lb/cu ft). The highest density for the test fill corresponded to a 9-sec Vebe time (Sert 1993).

Preliminary work at the project site consisted of constructing upstream and downstream cofferdams to dewater the area, removing the original structure, and excavating the foundation to sound rock. The rock surfaces were then pressure washed to ensure cleanliness and covered with a 13-mm (1/2-in.) layer of high-slump bedding mortar to fill fine cracks and open joints. The bedding mortar consisted of 320 kg/cu m (540 lb/cu yd) of cement, 154 kg/cu m (260 lb/cu yd) of fly ash, and 890 kg/cu m (1,500 lb/cu yd) of sand. A layer of conventional concrete was then placed on low areas along the entire mortar foundation to create a more level, workable surface and to fill holes too small for the RCC to penetrate (Benson and Pavone 1993).

To control placement temperature and take advantage of more-uniform moisture conditions, all RCC was placed at night when temperatures were below 20.9 deg C (70 deg F). The RCC was continuously mixed in a pug mill plant next to the construction site and delivered to the point of placement within 10 sec by a conveyor belt system (Figure 94). The end of the conveyor was supported by a pivoting column encased in corrugated pipe. At the beginning of construction, the pipe was embedded in the foundation rock. Later the column was extracted and embedded in RCC, enabling the conveyor to extend to any point on the dam (Bloomberg 1989).

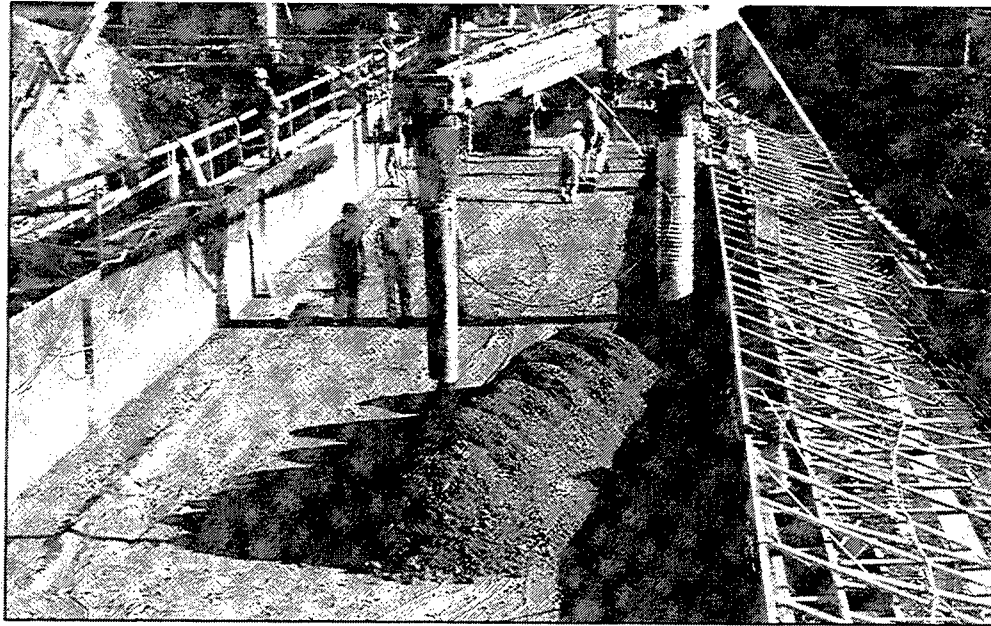

Figure 94. RCC delivered to Marmot Dam by a pivoting conveyor system (courtesy of Bloomberg 1989)

To prevent seepage, air-entrained concrete was placed in a 0.6-m- (2-ft-) wide, 0.3-m- (1-ft-) high section on the vertical upstream face just before the RCC was spread. A dozer was used to spread the RCC in 76- to 102-mm (3- to 4-in.) layers until a uniform 305-mm (12-in.) lift was achieved; the dozer tracks covered the interface between the two materials to eliminate segregation. The conventional concrete and RCC interface were consolidated with internal vibration prior to final compaction of the RCC with a 9,070-kg (10-ton) dual-drum vibratory roller. Vertical, crack-inducing joints were provided in the upstream concrete facing at about 9.1-m (30-ft) intervals. The joints were sealed with an elastic compound.

A thin layer of bedding mortar was spread over the entire RCC surface before each subsequent lift was placed to enhance bond between the lifts. During the course of construction, nuclear density tests performed at various depths in the 305-mm (12-in.) lifts showed that the densities of the bottom 152 mm (6 in.) were higher than those of the upper 152 mm (6 in.) if there were no delays between

lifts (Sert 1993). Subsequent tests on a 610-mm (24-in.) lift showed a 30.4 kg/cu m (1.9 lb/cu ft) increase in the average density. Consequently, the thicker lifts were used throughout the remaining placements thereby eliminating 50 percent of the bedding layers.

Also, between lifts of the RCC, reinforcing bars for anchoring the downstream reinforced-concrete face were installed at 1.2-m (4-ft) spacings. Near the crest, reinforcing bars were grouted into drilled holes. The 0.8:1 downstream face and the ogee crest were placed after the RCC was completed. Because the downstream RCC face was formed like nearly vertical stair-steps (Figure 95), the conventional concrete on that face was finished with a screed mounted on tracks and pulled up by winches. Weep holes were installed in the downstream face to prevent buildup of hydrostatic pressure should there be seepage through the dam (RCC Newsletter 1989a).

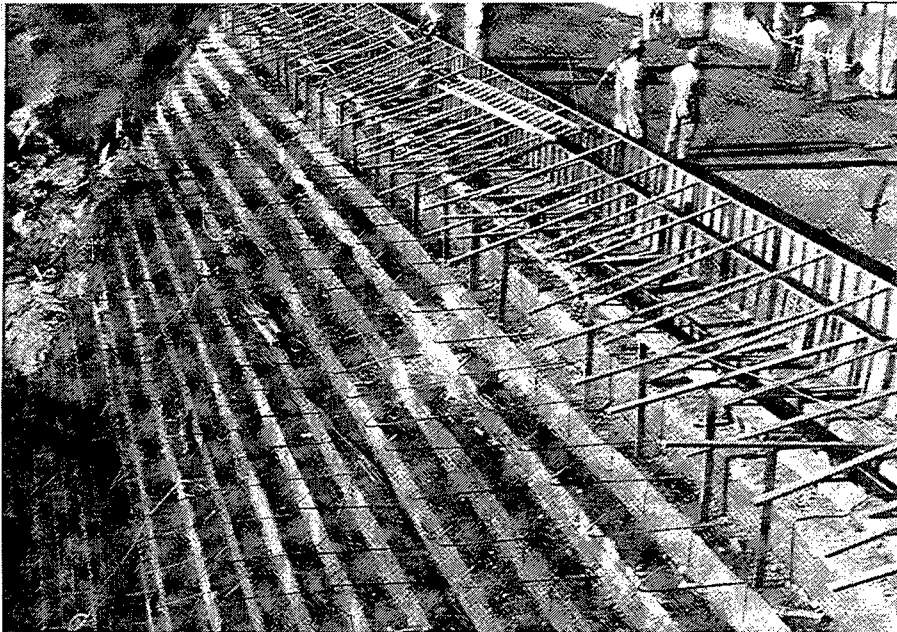

Figure 95. RCC on downstream face of Marmont Dam prior to placing conventional concrete facing (courtesy of Bloomberg 1989)

Concrete placement began in August; major construction was completed at the end of November. Approximately 7,645 cu m (10,000 cu yd) of RCC was placed in eleven 10-hr evening shifts. The in-place cost for the RCC, including all materials, was approximately \$73/cu m (\$56/cu yd) (RCC Newsletter 1989a); total cost for the structure was approximately \$2.55 million (Bloomberg 1989).

### Quail Creek South Dam

Quail Creek Reservoir is located approximately 24 km (15 miles) northeast of St. George, UT. The 49,340,000-cu-m (40,000 acre-ft) reservoir was originally

formed by zoned earth-fill embankment structures, a dike and a main dam. The dike, which was completed in April 1984, was 24.4 m (80 ft) high and had a crest approximately 610 m (2,000 ft) long. The main dam, completed in January 1985, is 61 m (200 ft) high and has a 295-m- (900-ft-) long crest. Reservoir impoundment began in April 1985 and foundation leakage quickly became a problem at the dike. To reduce leakage through the foundation, grouting programs were undertaken in 1986, 1987, and 1988. However, on January 1, 1989, the dike failed, releasing approximately 30,837,000 cu m (25,000 acre-ft) of water and causing about \$12 million in damage to the St. George area, but there was no loss of life (Jackson, Forrest, and Hansen 1990).

Later that month, the State Engineer appointed an independent review team to investigate the failure and determine whether a new dam could safely be built in the same place. The team attributed failure to seepage erosion and concluded that a new structure could be safely built at the site. The new structure is now called Quail Creek South Dam.

An investigation of the foundation revealed soluble minerals, with gypsum being the most abundant. The rate of gypsum solutioning can vary from a few inches to several tens of feet per year, depending on seepage velocity. To control seepage, engineers decided to construct a cutoff. The maximum depth of the trench was designed to be about 23 m (76 ft) at the center portion of the dam foundation. The trench tapers to 15.2 m (50 ft) deep at the left abutment and 7.6 m (25 ft) toward the right end of the dam. A 5.8-m- (19-ft-) deep cutoff slot was centered at the very bottom of the trench (Figure 96).

Backfilling the slot with lean conventional concrete and the trench with RCC was determined to be the most economical solution to the requirement for a non-erodible cutoff. RCC was also selected for construction of the dam. RCC was selected because it is cost effective, easy to construct, requires minimal equipment and labor, provides strength, and is durable (Gehring 1990). Also, an RCC dam would make the foundation area more accessible for maintenance than would an earth-fill dam, a high-capacity outlet could be more easily incorporated into an RCC dam, and the seepage erosion potential of an RCC dam is insignificant (Jackson, Forrest, and Hansen 1990).

Remnants of the original dike were removed and stockpiled, and the new dam was located on the axis of the original dike. To select an RCC mixture for the dam and cutoff fill, a testing program was conducted. Specifications for the RCC proportion were that it have a compressive strength of 11.0 to 13.8 MPa (1,600 to 2,000 psi) and a tensile strength of 1.4 MPa (200 psi) at 90 days. Also, it should have low permeability, high durability, and good workability. The same RCC mixture was used for the cutoff and the dam. RCC mixture proportions were as follows:

Material	Weight, kg/cu m (lb/cu yd)
Portland cement, Type V	80.1 (135)
Fly ash, Class F	53.4 (90)
Aggregate	2,236.7 (3,770)
Water	118.7 (200)

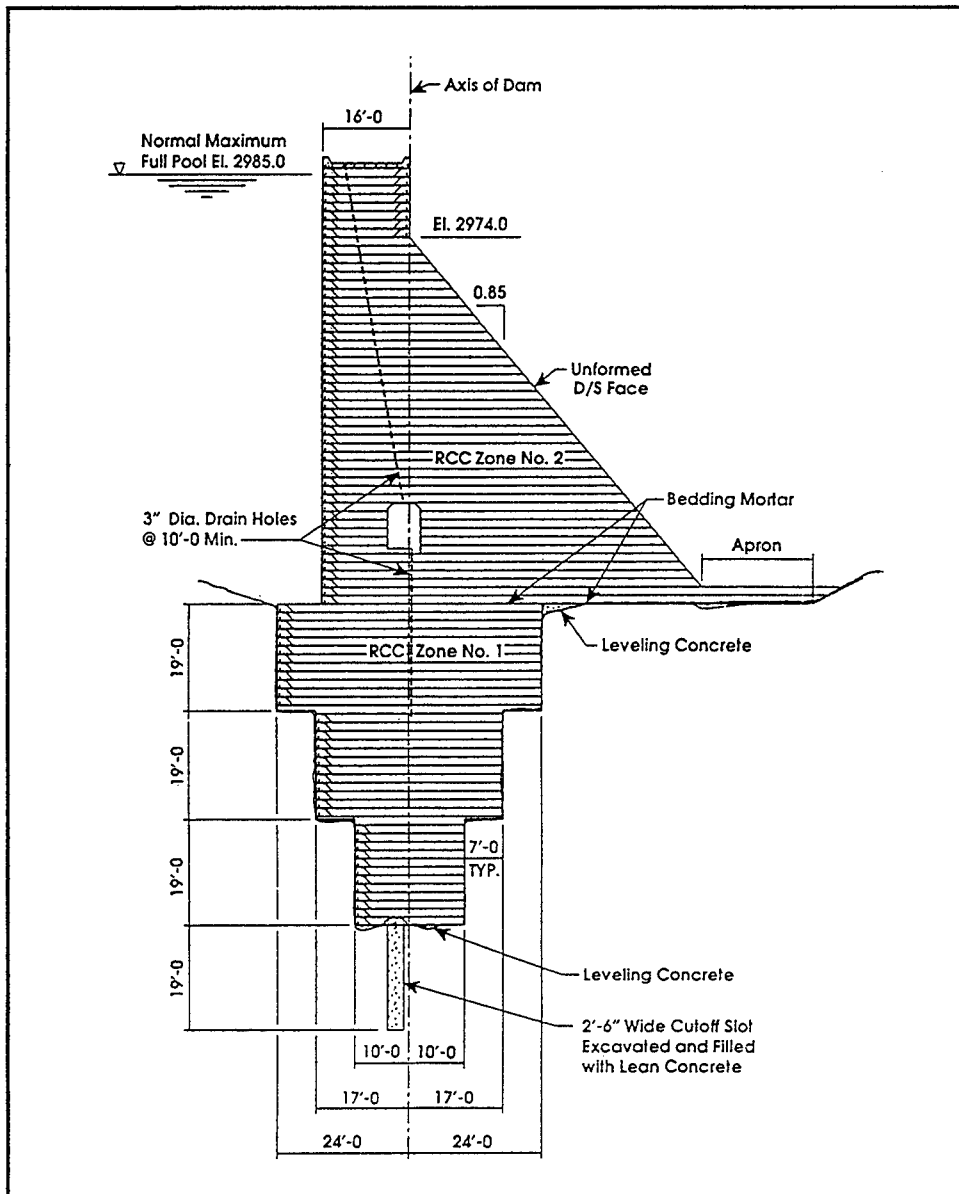

Figure 96. Maximum cross section, Quail Creek South Dam (courtesy of Gehring 1990)

The sandy gravel remnants of the original structure was used as aggregate for about 65 percent of the RCC. A suitable gradation (76-mm (3-in.) maximum size) was obtained with minimal processing. The remainder of the aggregate was obtained from a commercial pit about 3 kilometres (2 miles) from the site: the source of the original dike material. Type V cement was specified because of the potential for sulfate attack because of the soluble gypsum at the site (Jackson, Forrest, and Hansen 1990).

The contractor elected to place two trial sections prior to beginning construction of the dam to determine placement techniques and to establish procedures for quality control. As a result of the first test section, lift thicknesses were reduced from 457 to 305 mm (18 to 12 in.). The second trial, held a week later, determined that one 305-mm (12-in.-) lift, as opposed to two 152-mm (6-in.-) lifts, would produce satisfactory results with benefits in both productivity and quality. RCC placement for the cutoff trench began March 27 with production scheduled to be continuous over 20 to 24 hr/day for 60 days (Gehring 1990).

RCC was mixed in an automated dual-drum mixer located immediately upstream of the dam. Mixer performance testing during placement of the trial sections enabled the contractor to reduce mixing time to 80 sec for the 6.1-cu-m (8-cu yd) batches. The RCC was delivered to the project by a conveyor system, which discharged it into dump trucks that transported it to the placement area (Figure 97). Containment fins in dump trucks and on dozer blades, combined with careful dumping and spreading, resulted in little or no segregation of the RCC. After being spread, the RCC was compacted with three 10,890-kg (12-ton) drum rollers and two self-propelled rollers. Hand-held whacker rammers were used for compaction in hard-to-reach areas. Water wagons kept the surface moist between lifts.

A vacuum truck was used to remove any loose material between lifts. To increase protection against seepage erosion, broomable cement-sand bonding slurry was spread over at least a (16-ft) width on exposed, newly compacted lifts. Also, the contractor placed approximately 15,300 cu m (20,000 cu yd) of conventional concrete for leveling purposes and to seal the upstream face of the dam, particularly at the interface of RCC and native rock and between lifts (Figure 98).

Quality control consisted of testing both RCC and conventional concrete, checking aggregate gradation and moisture content, and testing RCC density and moisture content. Each lift of RCC was tested at a minimum of six locations, with field density tests consistently meeting or exceeding specifications (Gehring 1990).

Working two 10-hr shifts per day, 7 days per week, the contractor placed 48,200 cu m (63,000 cu yd) of RCC in the cutoff and 86,800 cu m (113,500 cu yd) in the dam in 2 months. The total construction cost was \$8,295,000. Cost of the RCC was \$23.90/cu m (\$18.27/cu yd) (Jackson, Forrest, and Hansen 1990).



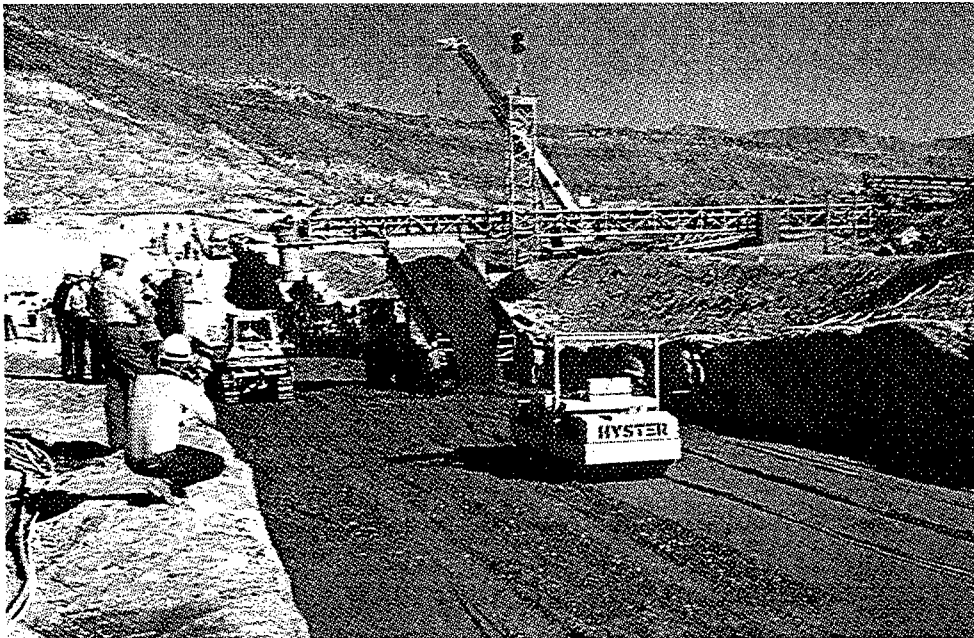

Figure 97. RCC placement, Quail Creek South Dam (courtesy of Gehring 1990)

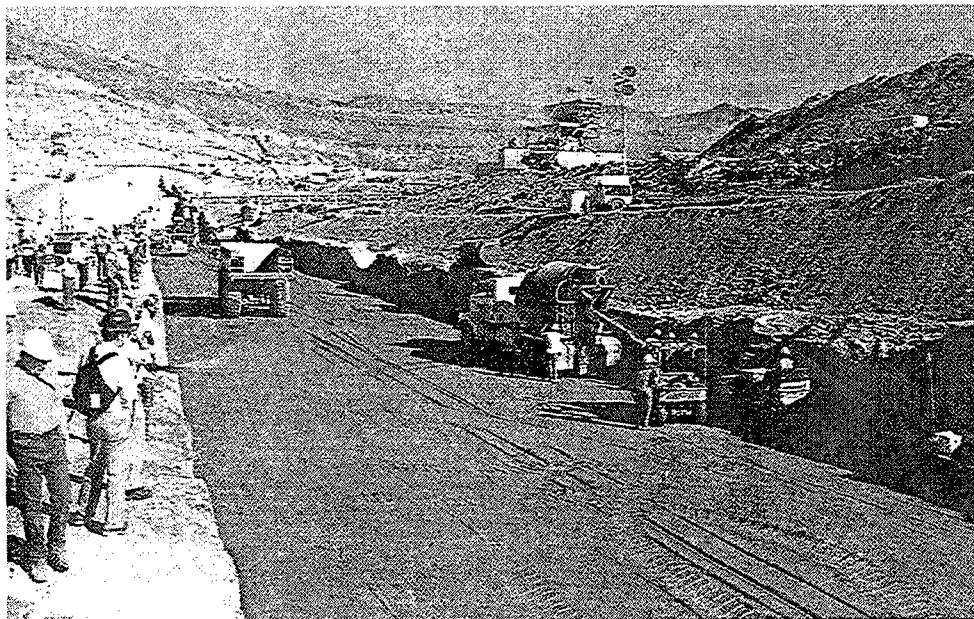

Figure 98. Conventional concrete placement on the upstream face of the cutoff trench, Quail Creek South (courtesy of Gehring 1990)

## Victoria Dam

Victoria Dam is located near Rockland in the upper peninsula of Michigan. The dam, which was constructed in 1930, is owned and operated by the Upper Peninsula Power Company. The original structure was a 36.6-m- (120-ft-) high concrete multiple arch-buttress dam. Over time, cycles of freezing and thawing caused deterioration of the downstream surface. When it became apparent that repairs made with epoxy injections would not permanently rehabilitate the dam, Upper Peninsula Power decided to replace the dam. Construction of a new RCC dam immediately downstream of the existing dam was found to be the best approach, both economically and technically. The new dam could be tied into the existing gated spillway and penstock intake structure on either abutment, saving the additional expense of replacing these structures.

The new dam is a straight axis gravity structure 36.6 m (120 ft) high with a crest length of 100.6 m (330 ft) including a 40.4-m- (132.5-ft-) long ungated overflow spillway. A typical cross section is shown in Figure 99. The RCC dam is encapsulated with a facing of conventional, air-entrained concrete. The design, construction, and performance of the dam is described in detail by Reynolds, Joyet, and Curtis (1993) and summarized here.

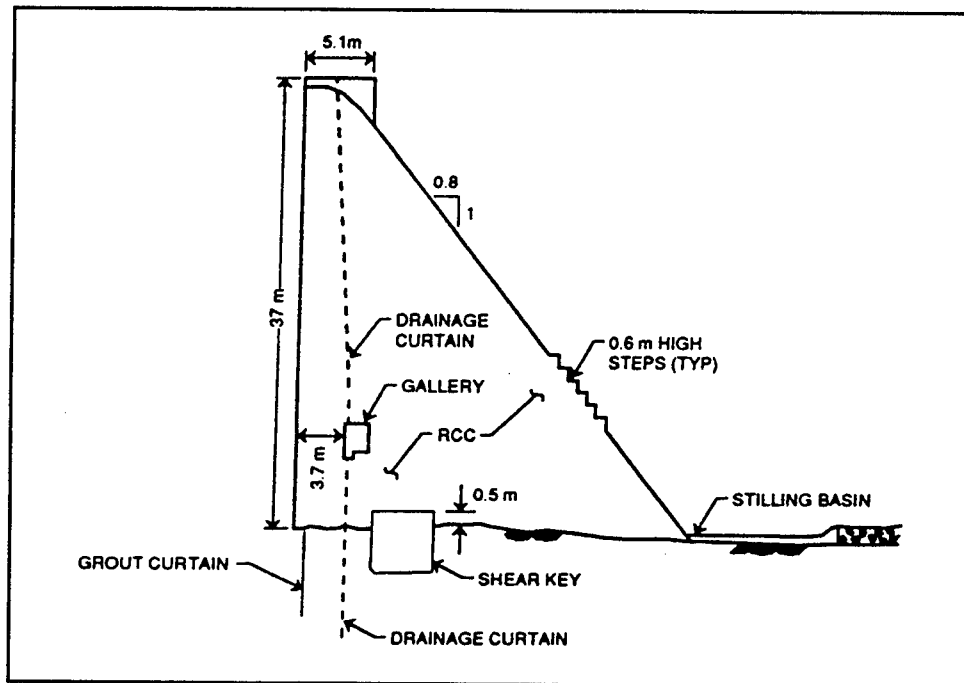

Figure 99. Typical cross section, Victoria Dam (courtesy of Reynolds, Joyet, and Curtis 1993, ASCE)

Specifications called for the RCC to have 90-day and 1-year compressive strengths of 9.7 and 13.8 MPa (1,500 and 2,000 psi), respectively. The required lift bond strength cohesion, assuming a friction angle of 0.8 radians (45 deg), was 0.34 MPa (50 psi). This strength was considered readily achievable with an RCC

compressive strength of 9.7 MPa (1,500 psi); therefore, laboratory shear tests were not conducted.

Trial mixtures were proportioned with cementitious contents of 118.7 and 148.3 kg/cu m (200 and 250 lb/cu yd) and 30, 40, and 50 percent cement replacement with Class C fly ash. Concrete proportioning procedures (sufficient cement paste to fill voids between aggregate) were used to develop mixture proportions. The RCC mixture selected for construction had a cementitious content of 133.4 kg/cu m (225 lb/cu yd) with 50 percent cement replacement with Class C fly ash. Since there was concern that Class C fly ash would produce a faster RCC set time, mortar set tests were conducted to determine the benefit of adding a water reducer/set retarder admixture. Based on the results of these tests, 0.30 l (8 oz) of water reducer/set retarder admixture per 45.4 kg (100 lb) of cementitious material was added. Aggregate used in the mixture was a hard, dense basalt, with a maximum size of 51 mm (2 in.). Approximately 35 percent passed the No. 4 sieve, and 5 percent, the No. 200 sieve. Vebe times were measured on a vibrating table with 254-mm (10-in.) diam, 0.4-cu m (0.5-cu ft) container and a 22.7 kg (50 lb) surcharge. The Vebe times were generally between 15 and 20 sec for mixtures containing 118.7 kg/cu m (200 lb/cu yd) of water.

A test fill placed before actual construction of the gravity structure began indicated the mixture developed in laboratory trials was too wet for placement. Reducing the water content to 106.8 kg/cu m (180 lb/cu yd) resulted in Vebe consistency times in excess of 35 to 45 sec. Since Vebe times greater than 30 sec are difficult to distinguish and are not meaningful, the contractor had to judge the consistency of the RCC by its appearance and behavior. If the RCC tended to segregate when it was deposited and spread, it was too dry. If it made a "sloppy" sound when it was dropped and then tended to stick to the vibratory roller, it was too wet. It was determined in the test fill that RCC with the ideal moisture content exhibited a classic pumping behavior during compaction, a nearly smooth paste-filled surface, and 13 to 25 mm (0.5 to 1.0 in.) depressions at the edges of the roller drum.

Pre-RCC placement preparation included construction of a shear key to help provide stability for the new gravity dam. The foundation on which the dam is built is primarily sandstone; however, thin veins of clay cross the site. The 4.6-m- (15-ft-) wide, conventional concrete key extends about 2.1 m (7 ft) into the foundation and 5 m (1.5 ft) into the RCC (Figure 99).

A 3.4-cu-m (4.5-cu-yd) capacity pug mill with separate batchers for all RCC components and a metered waterline was used for mixing the RCC. Computer controlled automatic batching and adequate mixing were achieved in 30 sec. A conveyor system was used to transport the RCC and deposit it at the placement location. It was spread in 356-mm (14-in.) loose lifts with a dozer and compacted with up to eight passes of a 9,070-kg (10-ton) double drum-vibratory roller. Succeeding lifts had to be placed within 10 hr or 500 deg F hr, whichever was less, to prevent cold joints. Cold joints had to be cleaned and covered with a 13-mm (0.5-in.) layer of bedding grout before the next lift of RCC was placed.

Lift surfaces were kept free of contamination. Only rubber-tired equipment was allowed on the RCC surface, and drivers were cautioned about making sharp turns. Any RCC that dropped from the conveyor was removed, and the surface was cleaned with a blower. Brooming and water flushing were limited because both tended to leave noncemented particles in the surface voids. When rainfall was heavy, work stopped and the surface was covered with plastic sheeting.

A drainage system consisting of a drainage gallery, foundation drains, internal drains, and a drainage curtain were installed to reduce hydrostatic pressures in the foundation and in the dam. In the top 5.2 m (17 ft) of the dam, bedding grout was used between each lift of RCC to reduce the potential of seepage along lift lines.

The facing concrete was nominally 10 mm (24 in.) thick. The conventional concrete mixture was proportioned with 19-mm (3/4-in.) maximum size aggregate for a compressive strength of 27.6 MPa (4,000 psi). The mixture contained air-entraining, water-reducing, and retarding admixtures. The facing concrete was placed following spreading and compaction of the RCC. Weighted H-beam sections were used to form the downstream steps.

A simple thermal analysis, based on worst case conditions, suggested that four cracks with widths of about 5 mm (3/16 in.) would develop in the RCC dam. Five contraction joints were installed with a maximum spacing of 25.6 m (84 ft). Vertical crack-inducing control joints were installed between contraction joints on the upstream face (Figure 100). The control joints were initially placed on 4.9-m (16-ft) centers, but the spacing was changed to 2.4-m (8-ft) centers when cracks occurred in the facing concrete during early stages of construction. The joints were sealed with a two-part, nonsag urethane.

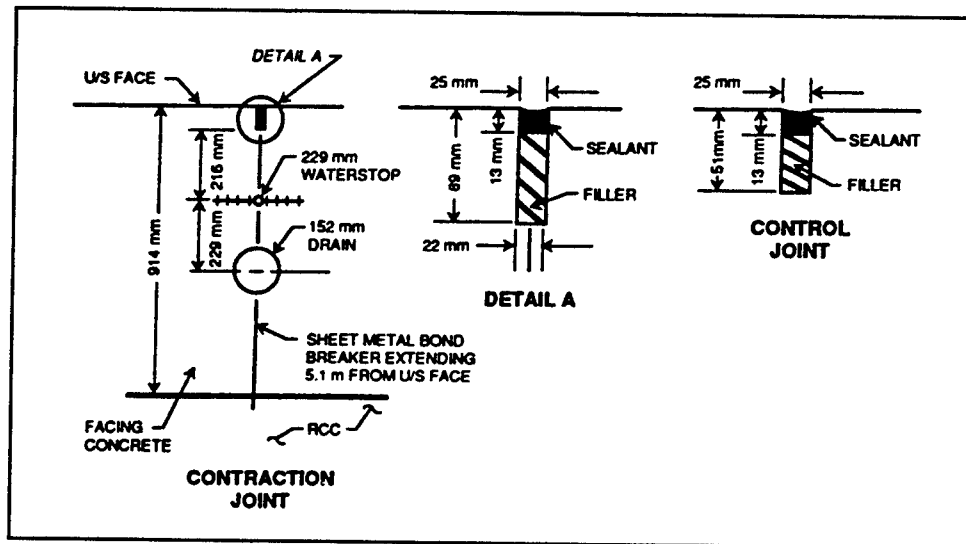

Figure 100. Contraction and control joints, Victoria Dam (courtesy of Reynolds, Joyet, and Curtis 1993, ASCE)

Quality control of the RCC during construction included visual inspection, density checks with nuclear density gauges at six locations per lift, and optimum compaction density tests. Also, a set of cylinders was made for each RCC lift; the cylinders were to be tested at 14, 28, 90, and 365 days. Eleven thermocouples were installed during construction so the temperature of the RCC could be monitored.

The project required 33,030 cu m (43,200 cu yd) of RCC and took about 8 weeks to complete. The contractor worked two 10-hr shifts 6 days per week. The 2-hr break between shifts was used for maintenance. Placement of the RCC and the facing concrete was completed in the fall of 1991. The reservoir was filled during the first 3 months of 1992. Seepage and RCC temperatures were monitored during and after filling.

Total seepage into the gallery increased to 833  $\ell$ pm (220 gpm) as the reservoir filled. One source of seepage was a surface fracture in the left abutment foundation. When this fracture was grouted, about 6 months later, total gallery seepage was reduced to approximately 284  $\ell$ pm (75 gpm). Most of the seepage came from foundation, contraction joint, and internal drains; about 7 percent came from seepage in the gallery perimeter. Drains in the central portion of the dam were dry. Some scattered damp spots were sighted on the lower one-fourth of the downstream face of the dam.

The seven thermocouples in the interior of the dam exhibited an average heat rise of 1.7 deg C (35 deg F). The maximum temperature reached in an RCC lift was approximately 38 deg C (100 deg F) and occurred about 6 weeks after the lift had been placed. Sixteen months after construction was completed, the internal portion of the dam had cooled to 18.5 deg C (65 deg F) and was still cooling.

One contraction joint is located approximately in the middle of the 39.6-m- (130-ft-) long gallery. After 1 year, this joint had opened about 1 mm (0.04 in.) around the entire gallery perimeter. In addition, one crack across the gallery near the toe of the right abutment slope had opened 0.8 mm (0.03 in.).

Results of 1-yr density and unconfined compression tests on RCC cylinders fabricated during construction are shown in Figure 101. Also, results of tests on 153-mm (6-in.-) diam, full-depth cores taken about 1 year after the dam was completed are included for comparison. The cores taken indicated that the RCC is generally well consolidated, with the bottom portion of the lifts being as well consolidated as the top. Lift lines where bedding mortar was used were easy to detect; some of the lift lines where no bedding mortar was used were not detectable. There were some void concentrations, most of them occurring near the bottom of lifts, but none were intense or continuous. The average core density was about the same as that for the cylinders. However, the compressive strength of the cores was only about 75 percent of that for the construction cylinders. Speculations are that since other factors--density, consolidation, curing conditions--were the same, the lower strength in the core could be the result of microfracturing caused by vibration from the compactor on overlying lifts.

Property	RCC Cores		RCC Construction Test Cylinders	
	Range	Average	Range	Average
Density kN/m <sup>3</sup> (pcf)	24.5 to 25.5 (156.2 to 162.3)	25.0 (159.0)	24.3 to 25.6 (155.0 to 162.8)	25.0 (158.8)
Approx. 1-Year Comp. Strength MPa (psi)	13.6 to 24.5 (1970 to 3560)	18.5 (2679)	14.0 to 34.8 (2030 to 5040)	24.8 (3587)

Figure 101. RCC density and compressive strength, Victoria Dam (courtesy of Reynolds, Joyet, and Curtis 1993, ASCE)

Results of shear strength tests performed on the RCC core are shown in Figure 102.

Condition Tested	Break-Bond		Sliding Friction	
	Cohesion MPa (psi)	Friction Angle	Cohesion MPa (psi)	Friction Angle
Intact RCC	1.93 (280)	64	0.26 (38)	47
Intact bedded lift	1.59 (231)	69	0.10 (14)	44
Intact non-bedded lift	1.19 (172)	62	0.17 (24)	48
Broken bedded lift	---	---	0.30 (44)	30
Broken non-bedded lift	---	---	0.07 (10)	36

Figure 102. RCC shear strengths, Victoria Dam (courtesy of Reynolds, Joyet, and Curtis 1993, ASCE)

Recommendations based on experiences in this project include the following: the double-probe density gauge is preferred over the single probe because it provides density measurements at specific depths rather than a weighted average of the zone between the surface and probe depth; visual observations during placement and compaction can provide good control of RCC consistency; the Hilti TP-400 hand-held vibrating hammer was faster and easier to work with than the vibratory table, and it gave equivalent results; and simple calculations and discernment, rather than expensive computer thermal analysis, were sufficient for design of contraction joints.

### Christian E. Siegrist Dam

High Bridge Dam, owned by the City of Lebanon Authority, was constructed on Mill Creek about 30 miles northwest of Harrisburg, PA, in 1946. When the spillway of the 21.3-m- (70-ft-) high earth-fill dam was determined to be inadequate according to current hydraulic standards, the Authority decided to replace the structure with a concrete gravity dam that would also increase the size of the reservoir to meet future needs. After studying several alternatives, it was

decided to construct a new RCC dam, Christian E. Siegrist, 121.9 (400 ft) downstream from the existing High Bridge Dam. RCC was selected for construction because it was more economical than the other alternatives (Hansen 1994). The new concrete gravity dam (Figure 103) is 39.6 m (130 ft) high and 213.4 m (700 ft) long. Precast concrete facing panels were installed on both

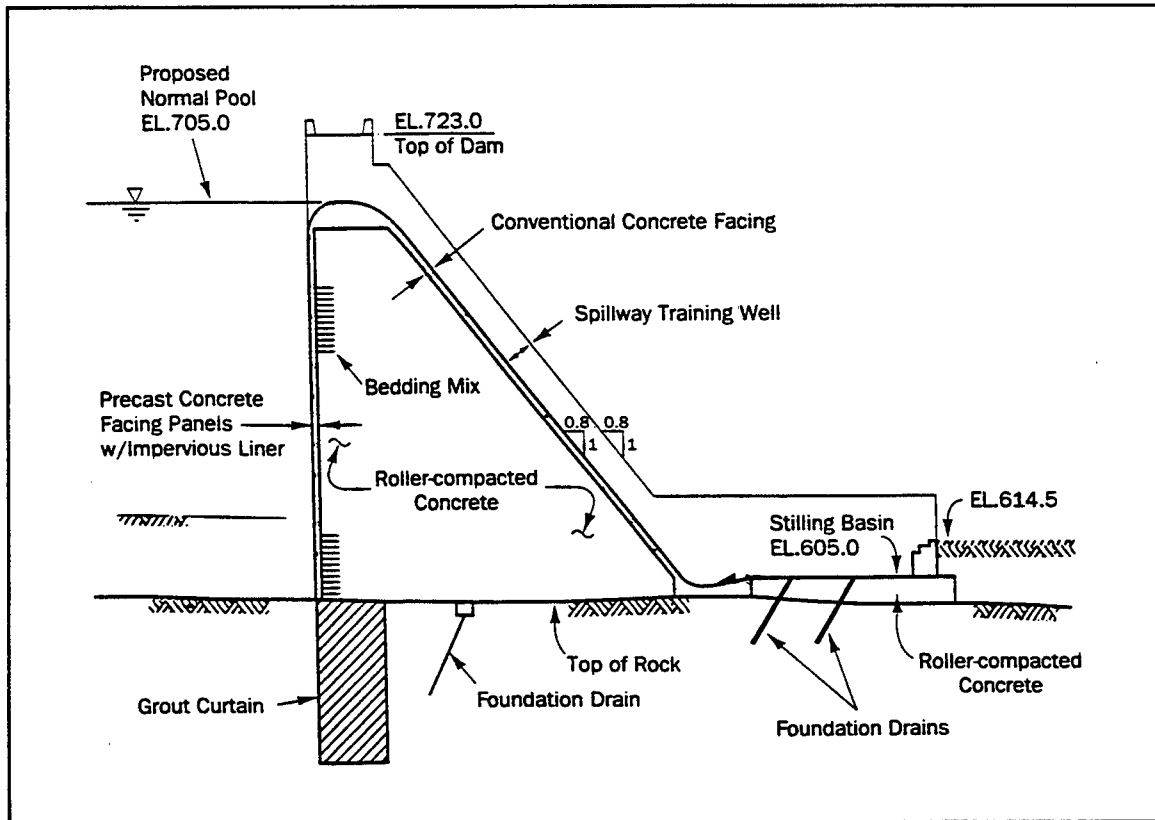

Figure 103. Cross section through spillway Siegrist Dam

the upstream and downstream surfaces of the dam. To meet the need for watertightness, the panels to be used on the upstream face were precast with a polyethylene liner on the interior face of the panels. Construction of Siegrist Dam is described by Holderbaum and Wilson (1992) and summarized in the following.

A full-scale testing program to determine the best RCC mixture for the project was conducted during the design phase. Aggregates were obtained from a commercial quarry. American Association of State Highway and Transportation Officials (AASHTO) No. 57 concrete aggregate with a maximum size of 38 mm (1-1/2 in.) was used as the coarse aggregate. A bituminous concrete sand with a maximum size of 10 mm (3/8 in.) and up to 14 percent minus 200 material was the fine aggregate. The aggregate blend was 52 percent coarse and 48 percent fine. This blend produced a mixture that could be placed with little segregation or rock pockets. Type II cement and Class F fly ash were supplied by a nearby producer. Water for mixing and curing of the RCC came from the existing reservoir.

A second testing program was conducted during the first year of construction. The purpose of this program was to refine the RCC mixture proportions with the materials proposed for use by the contractor. Fortunately, the contractor proposed the same sources of fly ash and aggregates that had been tested during design, thereby simplifying the construction-phase testing program. Seven mixtures, including a control mixture with no fly ash, were tested. These tests showed that the percentage of cement replacement with fly ash could be higher than that anticipated in the design-phase tests. Overall, four different RCC mixtures were used on the project:

Mixture	Material Weight, kg/cu m (lb/cu yd)			
	Cement	Fly Ash	Aggregate	Water
1	59.3 (100)	41.5 (70)	2,354.2 (3,968)	96.1 (162)
2	77.1 (130)	29.7 (50)	2,354.2 (3,968)	96.1 (162)
3	53.4 (90)	41.5 (70)	2,354.2 (3,968)	96.1 (162)
4	47.5 (80)	47.5 (80)	2,354.2 (3,968)	96.1 (162)

Mixture No. 2 was used in the stilling basin slab; the other three mixtures were used at various locations in the dam.

The contractor placed a test section just prior to beginning construction of the dam. The purpose of the test was to evaluate mixture performance; determine correct water content; determine placement, spreading, and compaction procedures; and to familiarize the work force with the overall construction procedures. According to specifications, the RCC was to be spread in two 153-mm (6-in.) lifts and then compacted; however, the contractor demonstrated that he could meet compaction requirements by spreading and compacting a single 305-mm (12-in.) lift. This procedure was used because it meshed with the contractor's other operations. The test section showed that 93 to 95 percent of theoretical-air-free density could be achieved by spreading and tracking of the dozer. Densities approaching 100 percent of theoretical-air-free density could be achieved by compaction with a vibratory roller if the RCC was mixed at, or near, the design water content.

Preparation for construction of the RCC gravity structure included dewatering the area and preparing the foundation. The foundation was cleaned with water and air-water washing equipment and vacuum equipment; fractures in the rock surface were grouted, and a high-slump conventional concrete bedding mixture was placed on the rock foundation.

A continuous-mix pugmill was used to mix the RCC onsite. A second pugmill was used to mix the bedding mixture and to serve as a backup should the pugmill for mixing the RCC break down. RCC was generally mixed at a rate of 229.4 cu m (300 cu yd) per hr. The mixture was transported from the mixing plant to a crawler-placer on the placement area by a conveyor system. The crawler-placer placed the RCC in windrows; it was then spread by a dozer in 305-mm (12-in.) lifts and compacted with a single-drum vibratory roller. Photographs of the conveyor system including the crawler-placer are shown in



Figures 104 and 105. In difficult-to-reach areas, walk-behind vibratory plate tampers and hand-operated “wackers” were used to compact the RCC.

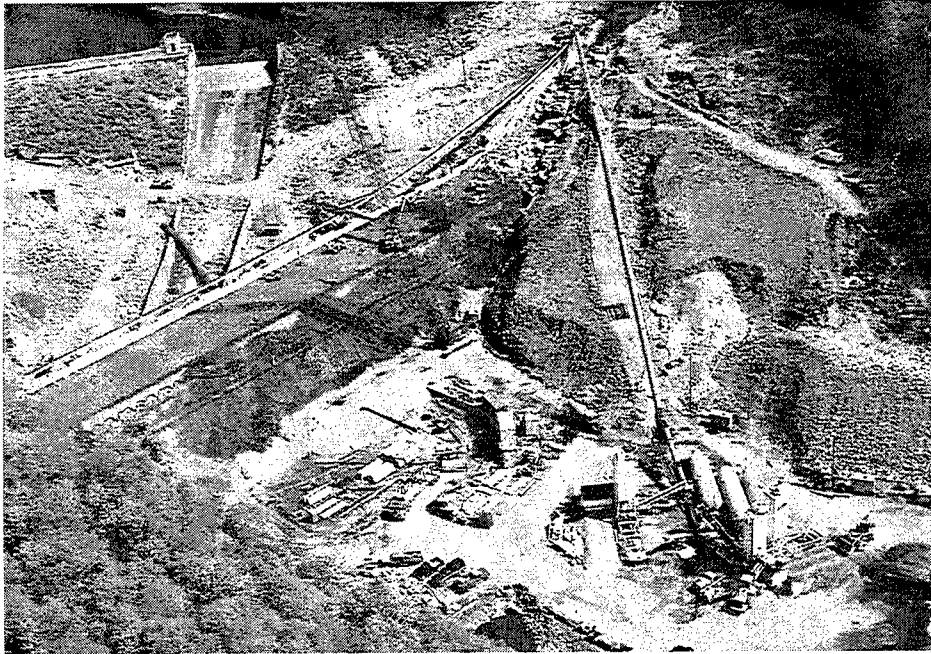

Figure 104. Overall view of project site, Siegrist Dam

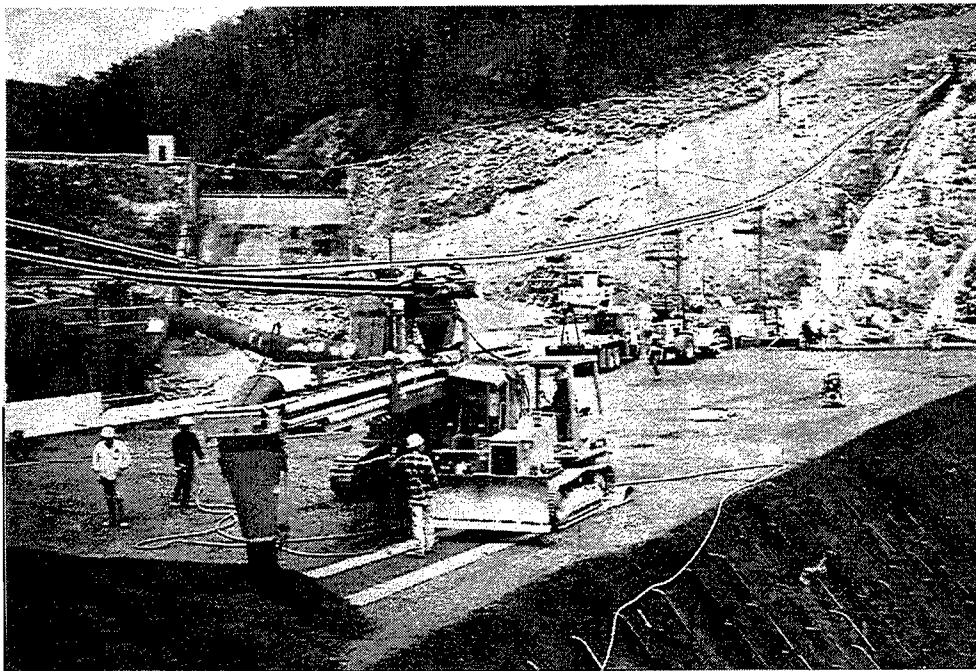

Figure 105. RCC placement, Siegrist Dam

A conventional concrete bedding mixture (127- to 229-mm (5- to 9-in. slump)) was placed on all areas of the rock foundation, on each lift surface at the upstream face and rock abutments, and adjacent to conventional concrete structures such as the diversion tunnel. The bedding mixture was also placed on the upstream 35 percent of lift surfaces classified as cold joints, lift surfaces that reached a maturity of 800 deg-hr prior to placement of the succeeding RCC lift. The mixture was delivered to the placement areas with a crane and bucket and manually spread in 25- to 51-mm- (1- to 2-in.-) thick layers. The bid price for the bedding mixture was \$3.59/sq m (\$3.00/sq yd).

Contraction joints were not included as part of the design plans; however, a joint detail was included in the construction drawings so joints could be added if necessary. During foundation excavation, it was concluded that a contraction joint was necessary to prevent cracking of the RCC at a discontinuity in the rock surface. Two additional contraction joints were deemed necessary after the thermal performance of the dam was reevaluated. The reevaluation became necessary because the beginning of the project, which was scheduled for March 1 to March 15, 1992, was delayed until April 4, 1992; by then ambient temperatures were higher. The average spacing between joints was 53.3 m (175 ft). Workers constructed a contraction joint by wrapping a sheet of plastic around a steel plate and placing it on a lift surface. After the next lift had been spread, they removed the joint plate, leaving the plastic sheet in place. The lift was then compacted as usual.

Each of the 1.2- by 4.9-m (4- by 16-ft) precast concrete panels that formed the vertical upstream face of the dam was anchored to the RCC with four 19-mm- (3/4-in.-) diam, 2.4-m- (8-ft-) long steel rods. The low-density polyethylene liner on the downstream face of the panels was welded at each panel joint to form a continuous membrane across the entire upstream face. An 457-mm (18-in.) strip of polyethylene was embedded in the foundation key wall and welded to the liner on the first row of panels. A total of \$96.88/sq m (46,000 sq ft) of precast panels was placed on the upstream face at a cost of 4,273 sq m (\$9.00/sq ft), in place, including the liner. The downstream face of the dam is on a slope of 0.8H:1.0V, except for the top 5.2 m (17 ft) which is vertical. This vertical section was formed with precast concrete panels without the liner. The downstream slope was faced with a 0.6-m (2-ft) layer of reinforced conventional concrete placed with the slip-form method.

Tests conducted on RCC lift surfaces included moisture content and density. During the first half of the project, a dual-probe nuclear gauge was used to determine in-place densities. Difficulties in using the dual-probe gauge and interpreting the test results prompted a switch to a single-probe gauge for the remainder of the project. The single-probe gauge produced more consistent and reliable test results. Laboratory tests included gradation and moisture content of the aggregates, cement content of the mixed RCC, percentage of coarse aggregate in the RCC, and compression strength of RCC cylinders. A total of 86 gradation

tests were run on the fine and coarse aggregates. Results of each of the 46 tests on the fine aggregate showed that the material was within specifications. Only a few of the 40 tests on the coarse aggregate showed that the material was not within specifications. In most cases, the material was only 1 to 3 percent outside of the specification limits on one sieve. In all cases, a retest or next test showed the material to be back within specifications. Results of compressive strength tests indicated that design strength of the RCC (13.8 MPa (2,000 psi at 1 year)) would be achieved at ages as early as 90 to 180 days, depending on the mixture used. At 56 days, the average compressive strength of Mixture No.1 was 12.8 MPa (1,850 psi).

A total of 64,990 cu m (85,000 cu yd) of RCC was used to construct Christian E. Siegrist Dam. The RCC was placed between April 4 and July 10, 1992. The contractor used two 10-hr shifts per day at the beginning and near the end of the construction period. During the middle, high-production phase of the project, he shifted to three 8-hr shifts 6 days per week. Production increased significantly after the last conduit was cleared with a maximum placement of (2,680 cu m (3,500 cu yd)) in a single day. RCC placement during the last month was often limited to the night shift to avoid hot weather and comply with RCC placement temperature requirements. The placement rate was further limited by placement of the precast panels on the dam faces. The cost of the RCC was \$50.36/cu m (\$38.50/cu yd) which included plant and conveyor mobilization, materials, mixing, conveying, and placing.

## Miscellaneous Applications

RCC has been used in a variety of applications in addition to rehabilitation and replacement of dams. These diverse applications include both repairs and new construction and the volumes of RCC used range from approximately 1,530 cu m (2,000) to almost 2,294,000 cu m (3,000,000 cu yd). Selected miscellaneous applications of RCC are summarized in Table 3 and described in the following case studies.

### Tarbela Dam

Tarbela Dam is located on the Indus River in the foothills of the Karakoram Range of the Himalayas in northern Pakistan about 65 km (40 miles) northwest of Islamabad. It is a 143.3-m- (470-ft-) high earth-fill structure that impounds 11,101,401,000 cu m (9 million acre-ft) of water, which is used to irrigate a large agricultural area and to provide 700 MW of power (Chao 1980). The outlet works consists of four tunnels and two spillways. Originally, the tunnels had an inside diam of 13.7 m (45 ft). The design capacity of the service and auxiliary spillways is 18,400 and 23,800 cms (650,000 and 840,000 cfs), respectively. Each spillway has a concrete chute with a flip bucket at the end (Johnson and Chao 1979).

**Table 3**  
**Summary of Miscellaneous Case Studies**

RCC Completed	Name of Project	Application	RCC Volume, m <sup>3</sup> (yd <sup>3</sup> )	Cement + Fly Ash, kg/m <sup>3</sup> (lb/yd <sup>3</sup> )	Unit Cost, \$/m <sup>3</sup> (\$/yd <sup>3</sup> )
1975	Tarbela Dam	Outlet tunnel repairs	382,300 (500,000)	112 + 0 (188 + 0)	
1978	Chena Floodway	Floodway sill	12,770 (16,700)	178 + 0 (300 + 0)	\$87.63 (\$67.00)
1980	Tarbela Dam	Spillway repairs	2,141,000 (2,800,000)	182 + 0 (238 + 0)	
1982	New Cumberland Lock	Lock floor pavement	1,645 (2,152)	208 + 0 (350 + 0)	\$95.48 (\$73.00)
1983	Northloop Detention Dams	Overtopping protection			
1993	Cache Creek Settling Basin	New weir	22,940 (30,000)	105 + 53 (177 + 90)	

Construction of Tarbela Dam was scheduled to be completed in 1974; however, the \$800-million project experienced a succession of failures and problems that extended the repair-construction period into 1981. Initial reservoir filling began July 1, 1974. In August 1974, Tunnel No. 2 failed. When the reservoir was drawn down, a collapsed section and damage to the intakes of Tunnels No. 1 and No. 2 were exposed. Additional problems included excessive numbers of sinkholes in the upstream blanket and upstream face of the dam and severe erosion to the stilling basins at Tunnels No. 3 and 4 and in the service spillway and the plunge pool (*ENR* 1977). Specialty concretes used to overcome the problems at Tarbela Dam included epoxy concrete, tremie concrete, fiber-reinforced concrete, and rollcrete (Chao 1980).

Rollcrete, or RCC, was used to repair damages in the intake area of Tunnel No. 2 and the plunge pool of the service spillway. RCC was chosen for these repairs because it required less time to mix and place than more traditional rehabilitation methods and it had the properties of low-strength concrete. The repairs are described in detail by Johnson and Chao (1979) and summarized in the following.

The collapsed portion of Tunnel No. 2 was approximately 76.2 m (250 ft) long. When the collapse occurred, the broken tunnel concrete, some of the reinforcement and supporting ribs, and about 756,000 cu m (1 million cu yd) of overlying bedrock and fill were washed out of the tunnel. The severity of the damage made it necessary to rebuild Tunnel No. 2, the area surrounding Tunnel No. 2, and to provide side support for Tunnels No. 1 and 3. This construction had to be completed within 6 months, before the next flood season.

The original repair plan was to remove the remaining section of the failed tunnel and put sand in the volume to be occupied by the new tunnel section simultaneously with the surrounding rollcrete. Later the sand would be excavated and the tunnel constructed in that space. However, because of the time factor, it became necessary to alter the plan. A decision was made to leave the remaining section of the tunnel in place and provide forming for the rollcrete on the right side of the section to form a cavity for reconstructing the tunnel with an 11-m (36-ft) inside diam, instead of 13.7 m (45 ft) because the larger diameter was no longer required for diversion. Because the conventional concrete production plant onsite was not capable of producing the required amount of concrete in the available time, engineers decided to use RCC. A rough test fill made by mixing cement with rounded boulder gravel (RBG) from the Indus River bed with a dozer confirmed that satisfactory results could be obtained. Most of the material passed a No. 20 sieve; that portion passing the No. 4 sieve was skip graded. Type I cement (the only type available in the required quantities) was used. Time restrictions prevented any action to control temperature in the RCC. However, placement was scheduled for January and February when the air temperature would range from 6.7 to 18.5 deg C (44 to 65 deg F), and the RBG was cool as it was excavated from near-river groundwater level. The repair plan for Tunnel No. 2 intake is shown in Figure 106.



Because of the short construction period, there was no time to import equipment for the mixing plant, so the mixing plant had to be constructed from the materials and equipment available at the site. A mixing tower was constructed that required RBG to be passed through a 229-mm (9-in.) stationary grizzly into a hopper and then elevated by conveyor belt to the top of the mixing tower. Cumulative weighing scales on the conveyor belt controlled the amount of RBG added, typically 1,800 to 2,000 metric tons per hour. Cement was hauled to the plant in bottom dump trucks, dumped into a hopper which fed onto a conveyor belt that sprinkled the cement onto the RBG on the elevating conveyor belt. Mixing water was sprayed on the cement/RBG at the top of the mixing tower. Mixing took place as the materials then fell through a modified rock ladder that was enclosed on all sides. The sections of the ladder were slanted about 30 deg from vertical (Figure 107). Although it was a crude plant, mixing appeared to be satisfactory. Segregation that occurred when the mixture was dumped into the trucks and again on the fill was generally corrected when the RCC was spread with a dozer. The biggest problem with the plant was the lack of a method for controlling the amount of cement added; therefore, the amount varied from approximately one-half to twice the desired amount. Average production for the plant was 13,000 cu m (17,000 cu yd) in two 10-hr shifts.

The RCC mixture was transported to the site in trucks. Dozers were used to spread the RCC in 457-mm (18-in.) lifts. Originally, it was planned to compact the material with a vibratory roller, but because the surrounding rock slopes were steep and unstable, a 25,400-kg (56,000-lb) truck loaded with 10,160 kg (22,400 lb) of concrete was used instead. When there was a delay between lifts, the placed RCC was sprayed with water from a hand-held hose before the next lift was placed.

Moisture content had to be determined from samples taken in place. The average moisture content of the minus 19-mm (3/4-in.) material was 6.6 percent. This material contained approximately 90 percent of the moisture. Because the grading of the rollcrete material varied widely, the moisture content of the total mixture varied from 1.1 to 3.9 percent. The calculated water-cement ratio (w/c) was 0.56.

Dry field densities averaged 2,571 kg/cu m (160.5 pcf), and wet densities (wc) averaged 2,640 kg/cu m (164.8 pcf). Later experiments indicated that these values should be decreased by 2.6 percent because a double plastic layer was used to line the excavated sample holes. The very high specific gravity of the plus 76-mm (3-in.) material (2.84 to 3.10) contributed to the high densities. In any event, compaction was highly satisfactory.

Compressive strengths of thirteen 152-mm (6-in.) cores taken from the RCC at about 70 days ranged from 8.7 to 34.1 MPa (1,260 to 4,950 psi), with an average of 17.4 MPa (2,530 psi). These results were consistent with the strengths obtained from cylinders. The average density of the cores compared favorably with the average wet field densities.

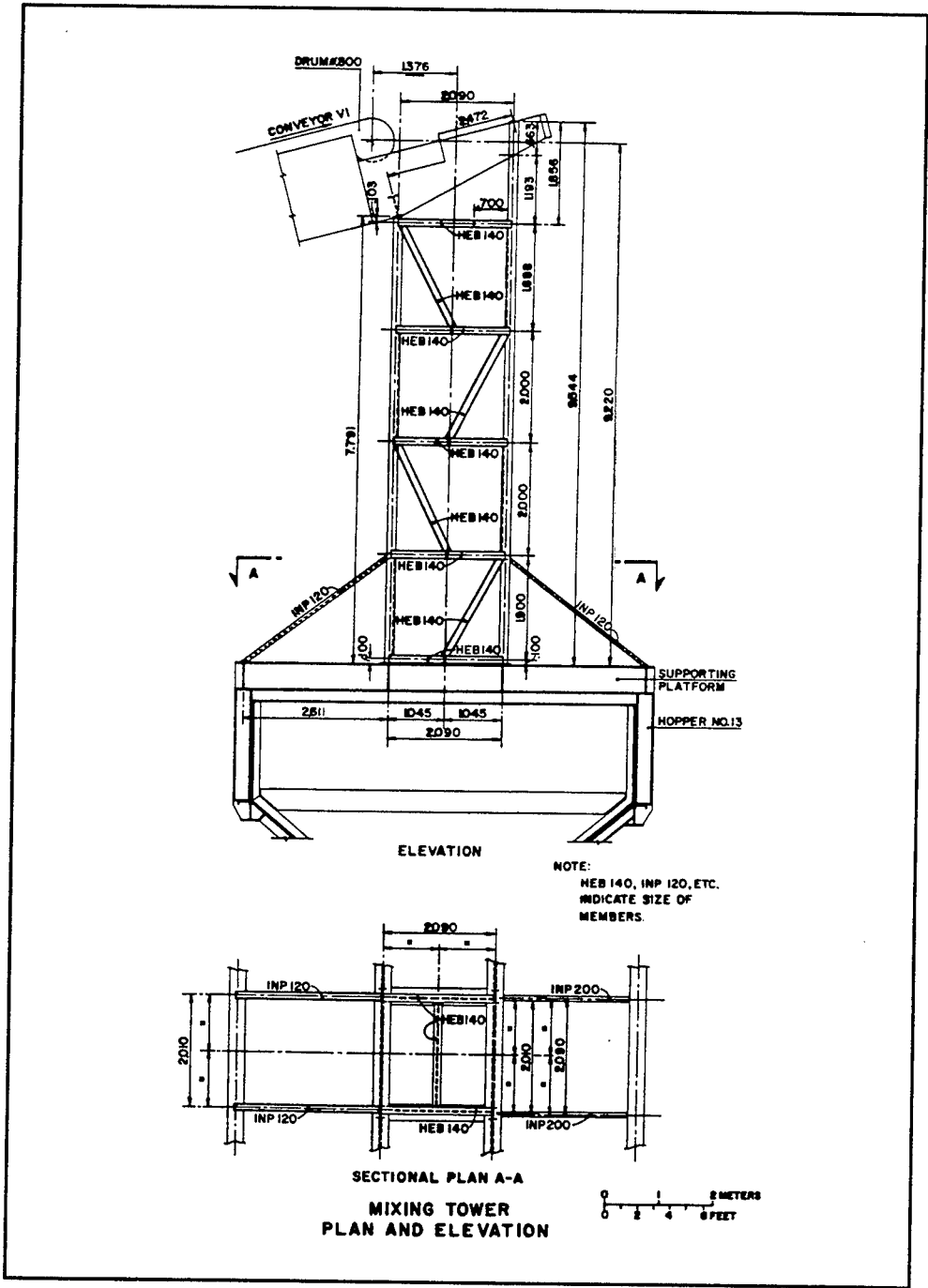

Figure 107. Mixing tower for RCC used to repair Tunnel No. 2 intake at Tarbela Dam (courtesy of Johnson and Chao 1979)

Four permeability tests were performed on the RCC in place. USBR Earth Manual Designation E-36 (1985) procedures were used. Three of the tests, in holes that had to be excavated with a hammer and a chisel, gave consistent permeabilities of 0.2 m (0.63 ft) per day to 0.4 m (1.4 ft) per day. The fourth hole, which was more easily excavated, had a value of 5.8 m (19 ft) per day.



The reservoir was filled when the tunnel repairs were completed and has remained filled except for seasonal variations. The RCC used to repair the tunnel appears to have performed satisfactorily.

In the summer of 1977, after only 26 days of operation, the plunge pool at the service spillway was eroded to the extent that it threatened to undermine the spillway flip bucket. In addition to this damage, minor erosion was discovered downstream of the auxiliary spillway. Erosion at both locations was caused by back eddies and peripheral flows. To solve the erosion problem at the service spillway plunge pool, engineers decided to remove the rock ridge that was causing the back eddies and peripheral flows and to provide barriers on the sides of the spillway jet. At the auxiliary spillway, two minor barriers were to be constructed to stop back eddies on the left side of the plunge pool. The general plan and typical sections for the repair are shown in Figure 108.

The estimated amount of concrete-like material that would be needed was a minimum of 535,000 cu m (700,000 cu yd). This material would have to be produced and placed in approximately 4 months. Because of these factors, RCC was selected as the material for the project. Because there was some uncertainty about how well RCC could withstand the abrasion caused by high-velocity flows filled with debris, a decision was made to face the RCC with a 1.5-m- (5-ft-) thick layer of conventional concrete. However, conventional concrete was not placed on one RCC strut on top of the dike to the left of the plunge pool.

The contractor had more time to construct a mixing plant for this project than he did for the tunnel repair, so he made several changes. The river bed borrow material was separated into two sizes, minus 19 mm (3/4 in.) and 19 to 152 mm (3/4 to 6 in.); revolving drum continuous mixers were obtained; and weighing equipment and batch counters for cement were added. A conveyor belt and vibratory screening plant were used to separate the aggregate and transport it to the revolving drum mixer. Cement and water, controlled by calibrated flows, were added at the mixer. The mixed RCC was fed by the mixing drums to a conveyor that carried it to a truck-loading hopper. Trucks delivered the mixture to the site. The RCC was spread in 330-mm (13-in.) loose lifts by dozers, which reworked material that showed signs of segregation (Figure 109). A 9,070-kg (10-ton) vibratory roller was used to compact the 330-mm (13-in.) lift to approximately 305 mm (12 in.). RCC surfaces were kept moist by hand-held hoses until the next lift.

Vibratory rollers, hand tampers, and trucks were used in an attempt to satisfactorily compact the RCC on the slopes; none were successful. To ensure bond between the RCC and the concrete facing, reinforcing bars were installed. Hooks embedded in the RCC had a radius twice the size of a standard hook, and the reinforcing bars were projected 1.5 m (5 ft) farther than the normal distance from the concrete boundary into the RCC to reach a fully compacted area.

Pullout tests were performed on reinforcing bars embedded in four RCC cylinders to determine the bond stress that would develop between the reinforcing bars and RCC. The cylinders compacted by the AASHTO method had bond

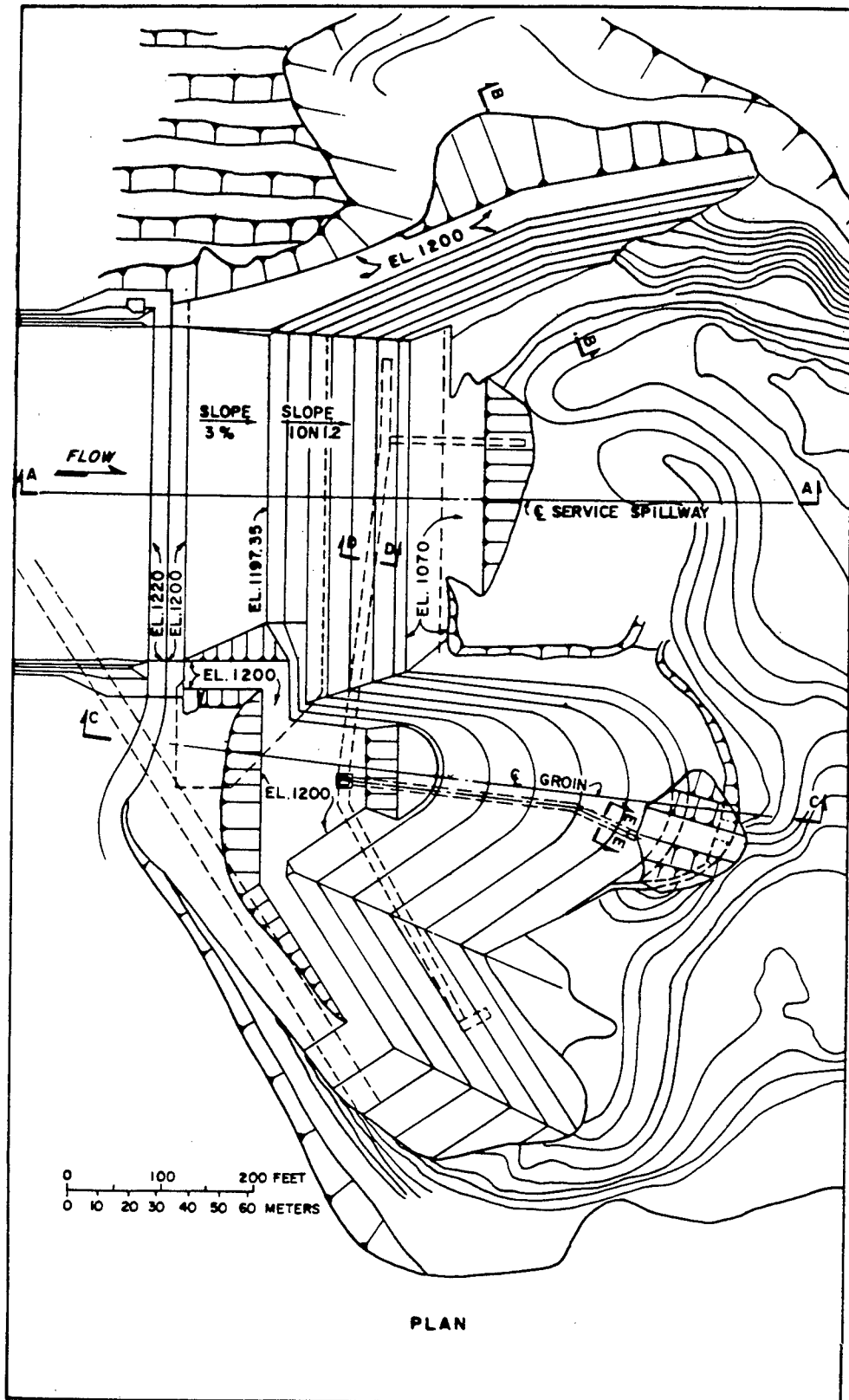

Figure 108. Service spillway repairs at Tarbela Dam (courtesy Johnson and Chao 1979) (Continued)

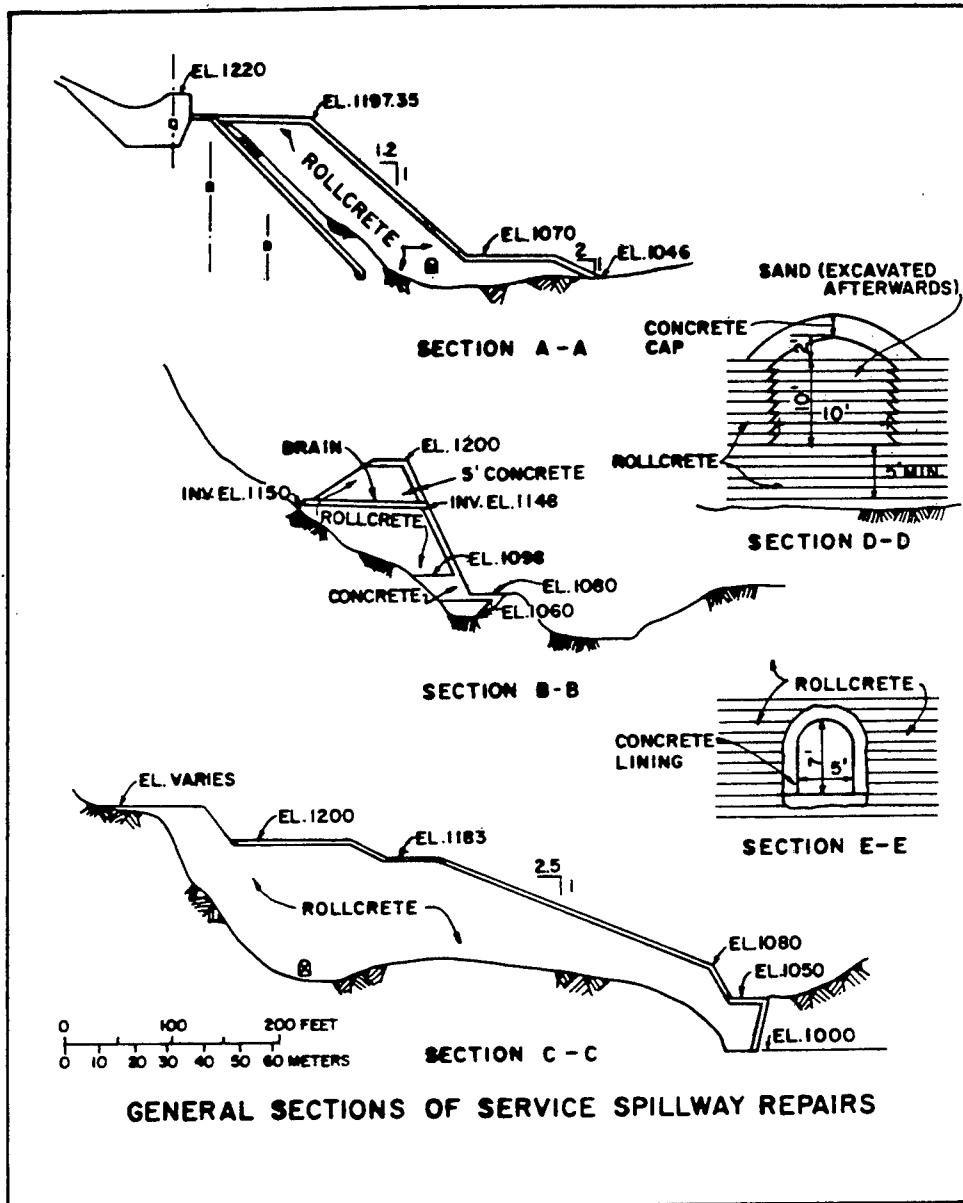

Figure 108. (Concluded)

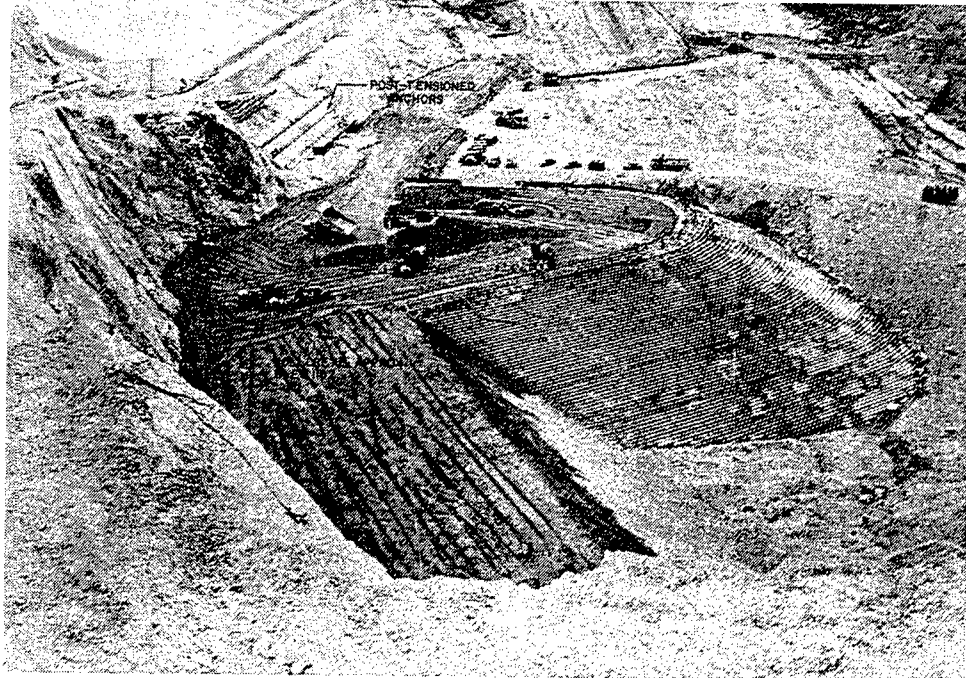

Figure 109. RCC placement at the service spillway, Tarbela Dam (courtesy of Johnson and Chao 1979)

stresses of 3.7 and 5.2 MPa (540 and 760 psi). The two cylinders compacted with the Kango hammer had bond stresses of 4.8 and (700 and 750 psi). The average 28-day compressive strength of cylinders compacted with the Kango hammer was 19 MPa (2,750 psi); the average compressive strength of cylinders compacted with the AASHTO rammer was 12.7 MPa (1,835 psi). It was felt that the compressive strength of the Kango hammer cylinder was more accurate for this project because compaction with the Kango hammer was more like compaction with the vibratory roller.

The aggregate grading for the RCC mixture was different from the RBG grading for the tunnel repairs because it came from a different location in the riverbed. The grading of the minus No. 4 material was improved; however, the shape of the particles was worse. In addition, 5 to 6 percent of the particles were soft; some of the larger soft particles crushed on the fill under the vibratory roller. Type I cement was used for the spillway repairs. No temperature measurements were made on the mixture. Galleries constructed in the RCC buttress in the spillway and in the groin by inserting uncement fill were excavated for an inspection in June 1979; no cracks had developed.

The repairs at Tarbela Dam demonstrated the feasibility of using RCC where a low-strength concrete that does not have to have uniform strength, high permeability, resistance to high-velocity flows or severe weathering conditions. It is especially useful when repairs have to be made in a short period of time. The quality of RCC used in the plunge pool was better than that used to repair the tunnels. This improvement was the result of dividing the aggregate into two sizes,

better control of the amounts of cement and water used, and the continuous drum mixers.

A total of 902,200 cu m (1,180,000 cu yd) of RCC was used in the construction of the buttress groin and the strut in the plunge pool area. Another 904,400 cu m (1,230,000 cu yd) of RCC was used to create a similar mass lining for the sides of the auxiliary spillway plunge pool (Hansen 1989b). The repairs and additional construction to the service spillway cost approximately \$123 million. Estimates for the auxiliary spillway were around \$90 million (Chao 1980).

After the repair project was completed, the spillway and adjacent area were tested with a 11,330-cms (400,000-cfs) flow for 6 hr. An inspection and sounding performed immediately after the flow was stopped, indicated no erosion, not even of the exposed RCC strut.

### Chena Floodway Sill

Options considered for providing erosion protection for the area downstream of a floodway sill at the Chena Project near Fairbanks, AK, included riprap, conventionally placed concrete, and RCC. Cost was a major factor in the decision to use RCC. Because of its scarcity in the Fairbanks area, riprap is expensive, but sands and gravels needed for RCC are plentiful and, therefore, less expensive. Also, placing conventional concrete is more expensive in Alaska than placing the RCC.

The RCC mixture for the project contained approximately 178 kg/cu m (300 lb/cu yd) of cement and 119 kg/cu m (200 lb/cu yd). The nominal maximum size of the aggregate was 38-mm (1-1/2 in.). The RCC was transported to the site in end-dump trucks where it was leveled with a dozer and compacted with a vibratory roller (Figure 110). A total of 12,770 cu m (16,700 cu

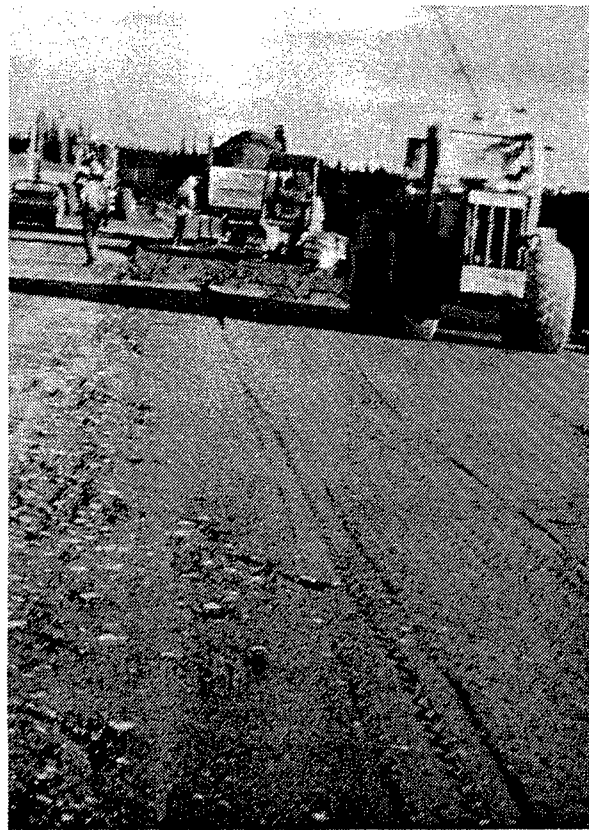

Figure 110. RCC placement at the Chena Floodway Sill (courtesy of Anderson 1984)

yd) of RCC was used to form the 12.2-m- (40-ft-) wide by 609.6-m- (2,000-ft-) long by 1.5-m- (5-ft-) high section.

The RCC section was placed in 14 days. The cost for the RCC, including cement, was \$87.63/cu m (\$67/cu yd). On the job, the cost for conventionally placed concrete, including cement, was \$220/cu m (\$168/cu yd) (Anderson 1984).

### **New Cumberland Lock**

New Cumberland Locks and Dam are located on the Ohio River near the city of New Cumberland, WV. The main lock is 365.8 m (1,200 ft) long and 33.5 m (110 ft) wide with a 6.4 m (21-ft) lift. RCC was used to pave the floor of the lock chamber between the upstream emergency bulkhead gate sill and the upstream miter gate sill (Anderson 1984). The RCC mixture contained 208 kg/cu m (350 lb/cu yd) of cement and 99 kg/cu m (167 lb/cu yd) of water. The nominal maximum size aggregate was 25 mm (1 in.).

A drop pipe was used to transfer the RCC from the top of the lock wall to the lock floor where it was placed with a front end loader, leveled with a dozer, and compacted with a vibratory roller (Figures 111 through 113). The RCC was placed in 0.3-m (1-ft) layers to a maximum thickness of 1.5 m (5 ft). A total of 1,645 cu m (2,152 cu yd) of RCC was placed at a cost of \$95/cu m (\$73/cu yd).

### **Northloop Detention Dams**

A series of flood detention dams called the Northloop project were to be constructed near Austin, Texas, in the summer of 1982. The structures were designed to be overflowed in the event of a 100-year flood. After a thorough study of the requirements of the project, engineers elected to use an RCC overflow section in the downstream portion of the detention dams (Figure 114).

In preparing to construct the RCC sections of the detention dams, engineers reviewed available data and literature on the use of RCC. They gained a general knowledge of RCC as a material but did not find information on the concise procedure for the design and construction quality control for an RCC structure. This case study is a summary of their findings and report on the Northloop project (Reeves and Yates 1985).

The engineers felt design, testing, and construction procedures used with an RCC project should be as simple as possible so everyone involved in the project could coordinate activities. They felt an RCC project should use familiar laboratory equipment, tests and technology, construction equipment and techniques, and quality control field tests and procedures. Reviewing the extensive work done in the Southwest with conventional concrete, soil cement, and cement treated road base, they took the position that RCC can be treated in the way as processed soil from the design phase through placing and field testing;

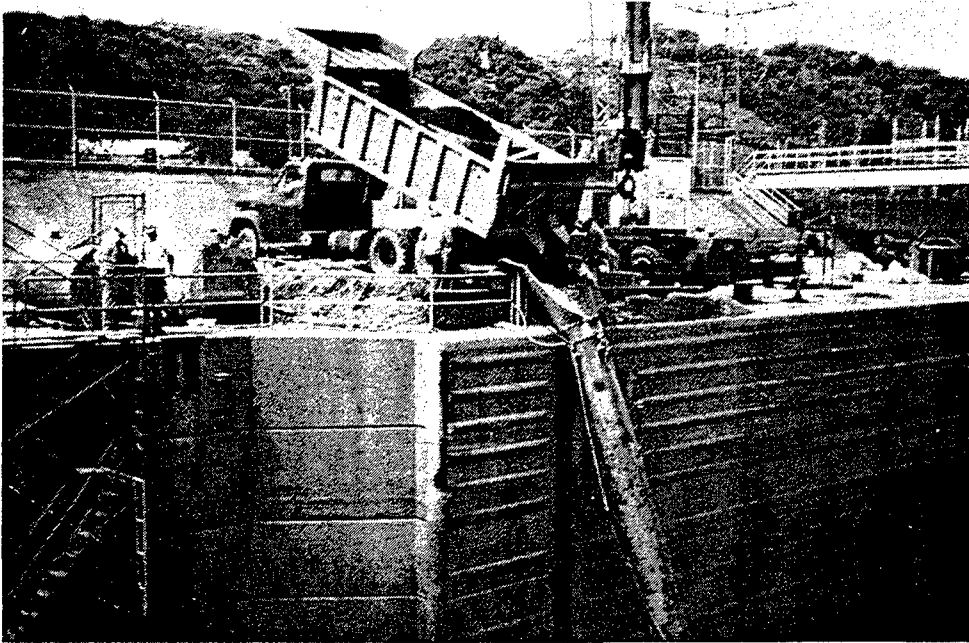

Figure 111. RCC being dumped into a drop pipe at the top of New Cumberland Lock (courtesy of Anderson 1984)



Figure 112. RCC delivered to the lock floor via a drop pipe at New Cumberland Lock (courtesy of Anderson 1984)

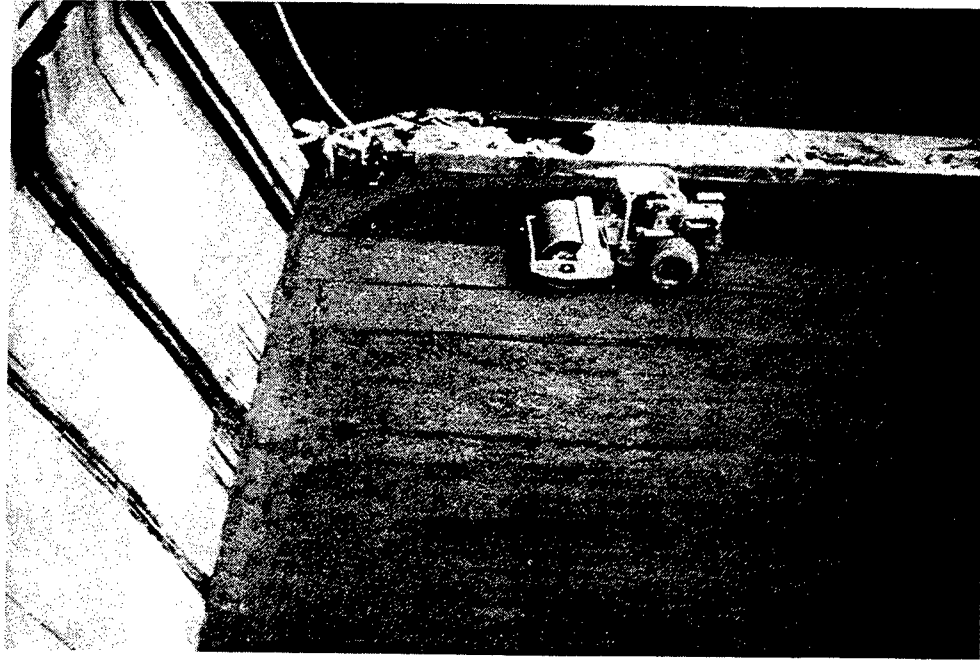

Figure 113. RCC being compacted, New Cumberland Lock (courtesy of Anderson 1984)

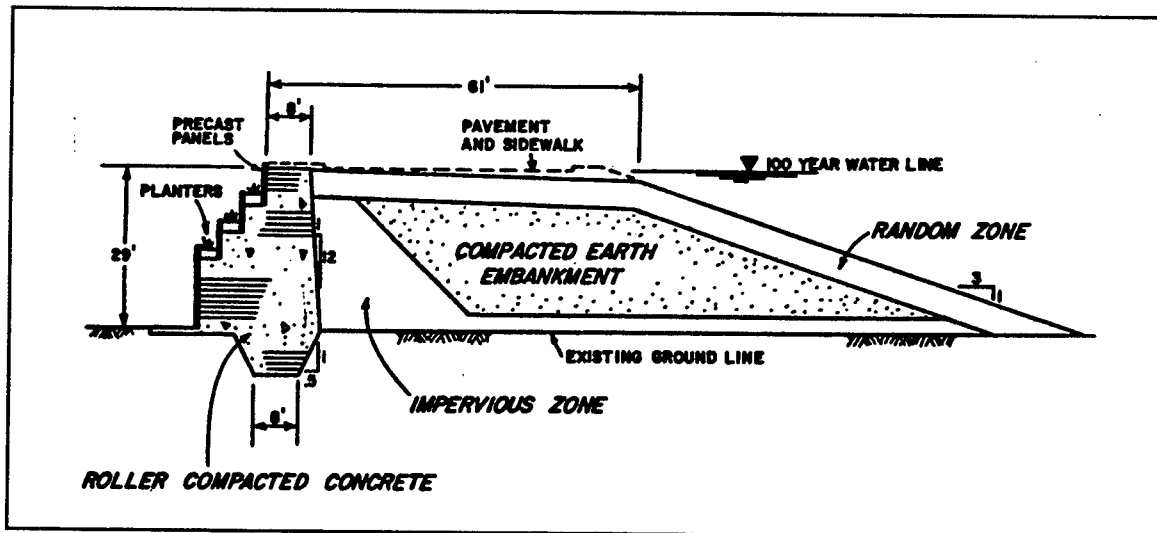

Figure 114. Cross section of typical Northloop flood detention dams (courtesy of Reeves and Yates 1985, ASCE). (Multiply feet by 0.3048 to obtain metres)



however, once placed, it should be cured and treated in the way as conventional concrete.

By treating RCC as a processed granular soil, contractors can use standard soil mechanics methods and theory to determine the expected behavior of the material. For example, with processed soils, compressive strength increases and permeability decreases as unit dry density increases. According to soil compaction theory, increasing compaction results in higher dry density and low optimum moisture content. It is important to note that water, according to soil compaction theory, lubricates the mixture so that a higher dry density can be obtained with a given compaction effort. Therefore, more water, up to the optimum, than is needed for cement hydration may be required to obtain greater dry density and thus greater strength after curing.

Also, contractors applying soil compaction theory to RCC materials must consider the sizes and grading of aggregates. High dry densities are achieved with RCC that has well-graded granular aggregate with a range of sizes, including a minus #200-mesh sieve constituent with little plasticity so that the strength and durability of the mixture will not be adversely affected.

Aggregate for the Northloop project was obtained locally. It consisted of crushed limestone with a maximum size of 38 mm (1-1/2 in.) and 8 to 16 percent very low- or nonplastic fines. (Fines as applicable to clay and silt means particles that pass a No.200-mesh sieve.) The amount of cement and fly ash used was based on data established at previous RCC projects. Compressive strengths were confirmed by laboratory and field tests. The mixture proportion, by dry weight of solids, was aggregate, 92.3 percent; cement, 5.5 percent; and fly ash, 2.2 percent. The amount of water to be used was determined from laboratory compaction tests.

Three test methods were used to test density and moisture content of the RCC mixtures. ASTM D 698 (Standard Proctor) (1994a) and ASTM D 1557 (Modified Proctor) (1994b) test methods are standards used in laboratories to determine maximum dry density and optimum moisture content. The Standard Proctor test relies on a relatively low compaction effort; the Modified Proctor, a high compaction effort. Another test method, developed by the Texas State Department of Highways and Public Transportation (TEX-113-E) specifies a variable compaction effort that depends on the plasticity and grain size of the soil. The TEX test method uses a larger mold for casting the test cylinders than does either of the ASTM test methods. This mold allows aggregate to 44-mm (1-3/4 in.), while the maximum size aggregate allowed by the ASTM molds is 19 mm (3/4 in.).

The larger TEX mold was used for initial testing for the Northloop project because all of the aggregate could be used in the laboratory testing. An attempt was made to extrude the specimen from the rigid mold after compaction so compressive strength tests could be performed on the cured samples. Problems with this procedure caused the contractor to substitute a mold conforming to

ASTM C 470 (1973) for compaction testing. The change in cylinders enabled the contractor to complete the tests.

Compaction was specified to be accomplished by four passes of a 9,070 kg (10-ton) vibratory roller for each 254-mm (10-in.) lift of RCC. A series of compaction tests were conducted in the laboratory. Identical samples of the Northloop RCC mixture were used for the tests. The compaction effort was varied for each series of tests so that behavior of the RCC mixture could be compared to that of conventional soil compaction theory and to identify the anticipated field compaction effort for the specified vibratory roller, number of passes, and lift thickness. The compaction effort was changed by changing the number of blows per layer. The results of the laboratory compaction tests revealed that the RCC performed in accordance with soil compaction theory: the maximum dry density increased and optimum moisture decreased with increasing compaction effort.

After compaction and density testing were complete, the samples were removed from the molds and cured in a moist room. Then they were tested to determine compressive strength; ASTM concrete testing procedures were used. The test showed the cured strength of the RCC mixture to be proportional to the dry density achieved in compaction.

Results of the laboratory compaction and compressive strength tests indicated that the quality of the RCC mixture could be controlled in the field by proper mixing of the materials in a calibrated, onsite pugmill and direct measurement of the density and moisture content of each compacted layer of RCC. Portable nuclear gauges were used for the field testing. Tests on the first layers of RCC indicated that the material could be compacted to near 100 percent of the maximum dry density established in the laboratory with the Modified Proctor compaction effort. The optimum moisture content from the laboratory compaction curve was used to determine the amount of water to be used for field mixing. Compressive strength tests performed on field cores showed that the RCC increased in strength with age similar to the way conventional concrete behaves.

Because cold-joint treatment is crucial from the standpoint of performance and important from the standpoint of cost, the contractor constructed a full-scale test section at the Northloop project to evaluate four cold-joint treatments. A layer of RCC was placed, compacted, and allowed to cure for 14 days; then it was divided into four sections, and each section was given a different treatment before a subsequent layer of RCC was placed. The four treatments were (a) water only, (b) dry cement only, (c) water/cement slurry, and (d) water/cement/sand mixture. Vertical cores (102 and 152 mm (4 and 6 in.) diam) were drilled through each treated joint section. A third point flexural test at the joint and at an unjointed section of the core sample was used to evaluate the bonding material. The results are shown below:

Types of Joint Treatment	Failure Load at Joint, N (lb)	Failure Load at Unjoined Section, N (lb)	Joint/Load Ratio
Water only <sup>1</sup>	9,790 (2,200)	46,260 (10,400)	0.21
Water only <sup>2</sup>	8,670 (1,950)	17,570 (3,950)	0.51
Cement only <sup>1</sup>	20,910 (4,700)	48,930 (11,000)	0.43
Cement only <sup>2</sup>	7,120 (1,600)	17,790 (4,000)	0.40
Water/Cement <sup>2</sup>	11,340 (2,550)	22,240 (5,000)	0.51
Water/Cement <sup>2</sup>	5,340 (1,200)	21,350 (4,800)	0.25
Water/Cement/Sand <sup>2</sup>	5,780 (1,300)	19,130 (4,300)	0.30
Water/Cement/Sand <sup>2</sup>	4,890 (1,100)	17,790 (4,000)	0.27

<sup>1</sup> 152-mm (6-in.) diam;

<sup>2</sup> 102-mm (4-in.) diam

To determine permeability of the cold joints, the contractor used the vertical core samples from the field test section for further testing. Smaller cores were drilled through and parallel to the treated joint. The cores were encased in a flexible-wall permeameter and placed under steady seepage conditions. Vertical flow through a typical, unjoined core sample was measured. Results of these tests are summarized below:

Type of Joint Treatment	Flow Condition	Coefficient of Permeability, cm/sec
Unjoined	Vertical	$2.3 \times 10^{-6}$
Water only	Horizontal	$1.3 \times 10^{-6}$
Water only	Horizontal	$8.2 \times 10^{-6}$
Cement only	Horizontal	$1.2 \times 10^{-6}$
Cement only	Horizontal	$2.1 \times 10^{-6}$
Water/Cement	Horizontal	$2.2 \times 10^{-6}$
Water/Cement	Horizontal	$3.0 \times 10^{-6}$
Water/Cement/Sand	Horizontal	$2.4 \times 10^{-7}$
Water/Cement/Sand	Horizontal	$1.5 \times 10^{-7}$

Since the Northloop project was completed in 1983, the design and quality control procedures used at Northloop have been used on three other projects. Materials used at these projects were the aggregates, cement, and fly ash available locally, but the laboratory procedures used to determine the proportions for each mixture were those used at the Northloop project.

### Cache Creek Weir

The original Cache Creek Settling Basin was completed in 1937. Prior to its construction, Cache Creek flowed unchecked from Clear Lake, down the eastern

slope of the Coast Range, across the Central Valley floor, and into the Sacramento River. Along its route, it picked up, carried, and deposited sediment, which adversely affected flood control and navigation. As a solution to this problem, the Corps of Engineers constructed the settling basin at the mouth of the creek where it enters Yolo Bypass about 3.2 km (2 miles) east of the city of Woodland and 24 km (15 miles) northwest of Sacramento, California. The perimeter levees; the project also had a cobble outlet weir and "training" levees that directed creek flow into the basin. Over time, sediment filled the basin and overflowed into Yolo Bypass, reducing the effectiveness of the flood-diversion channel. Consequently, the California Reclamation Board and Corps of Engineers agreed in 1990 to increase the capacity of the existing settling basin.

The old 426.7-m- (1,400-ft-) long, 0.6-m- (2-ft-) high cobble weir was replaced with a new 530-m- (1,740-ft-) long, 4.6-m- (15-ft-) high RCC weir. The height of the perimeter levees was raised to about 5.5 m (18 ft), an average increase of approximately 4 m (12 ft), and the upstream levee was enlarged. The old training levees were demolished, and new training levees were constructed nearer the western perimeter levee (Figure 115). The rehabilitated settling basin is expected to provide a 50-year storage capacity.

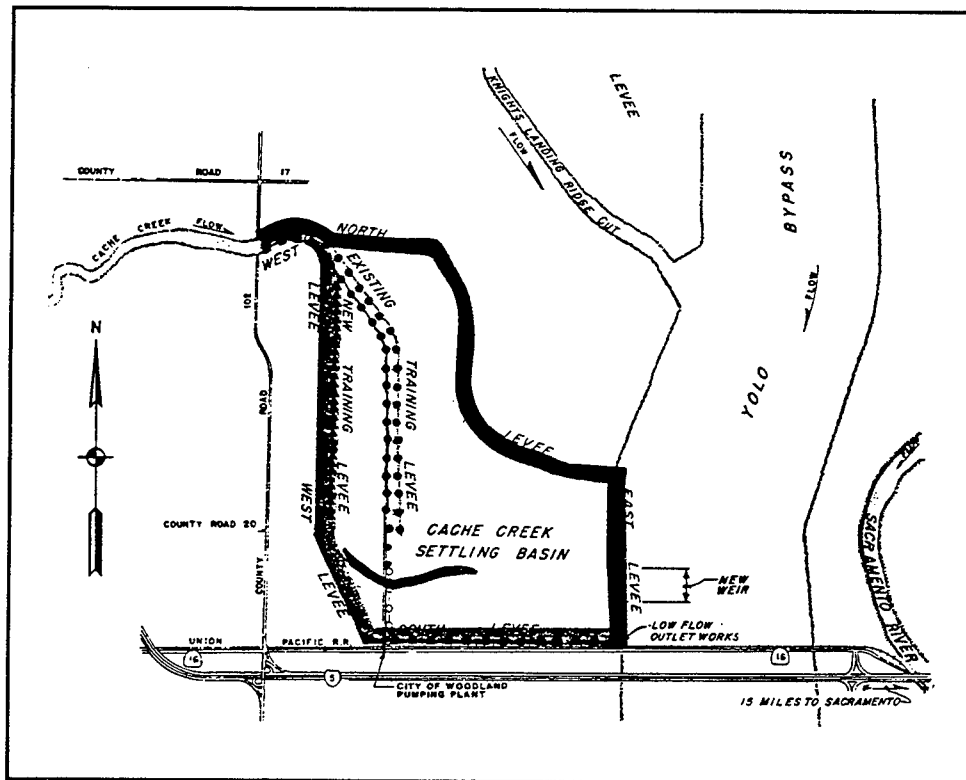

Figure 115. Layout of Cache Creek Settling Basin

Mixture proportions for the RCC used in construction of the weir (Figure 116) were as follows:

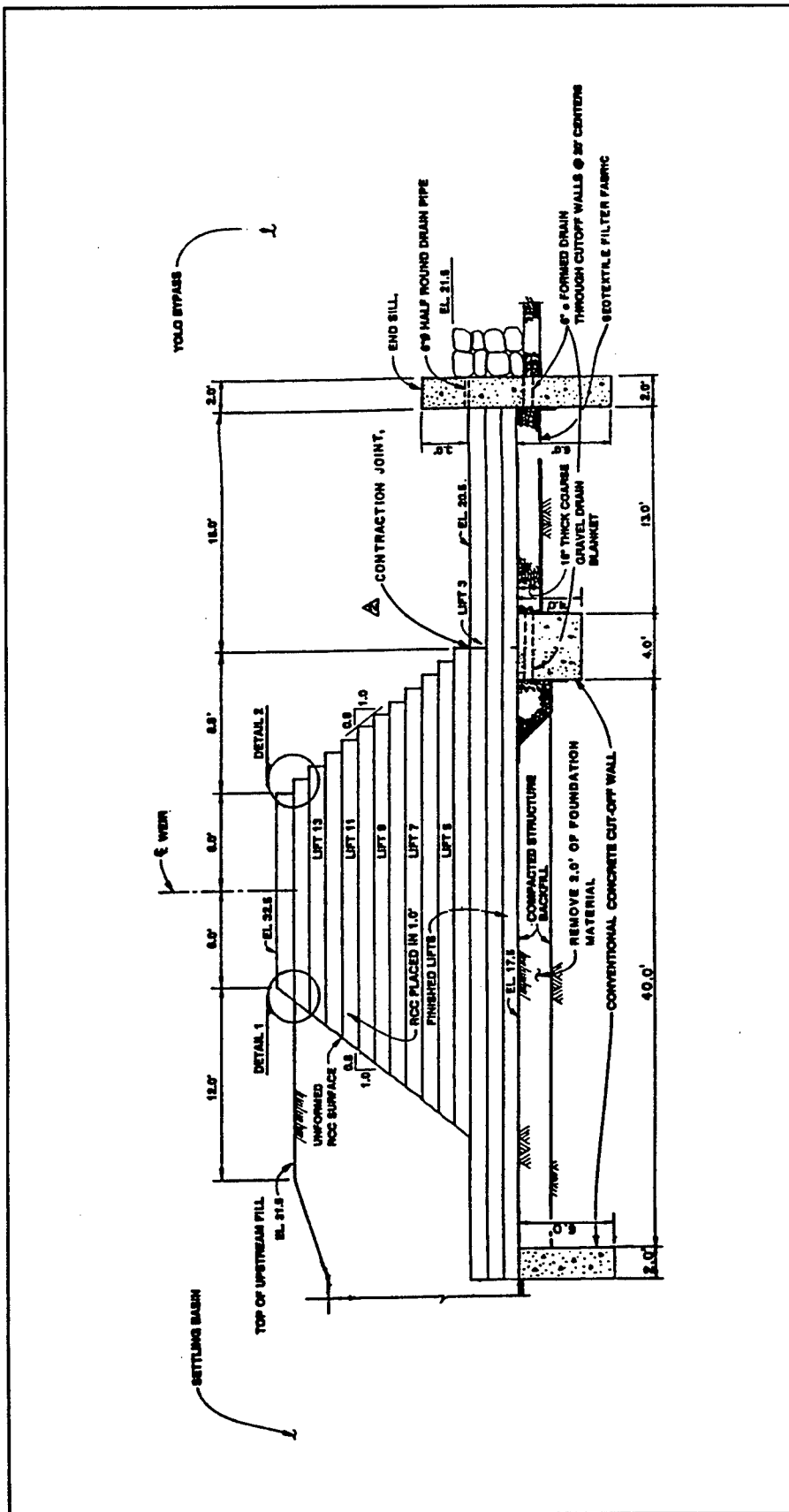

Figure 116. Section through RCC weir constructed at Cache Creek Settling Basin

Material	Weight, kg/cu m (lb/cu yd)
Portland cement, Type II	105.0 (177)
Fly ash, Class F	53.4 (90)
Fine aggregate	817.6 (1,378)
Coarse aggregate, 19 mm ( 3/4 in.) max	850.2 (1,433)
Coarse aggregate, 38 mm (1-1/2 in.) max	600.4 (1,012)
Water	99.7 (168)

The mixture had an air content of about 1 percent and Vebe times were between 12 and 15 sec.

The RCC was mixed in a continuous pugmill and placed in 0.3-m (1-ft) finished lifts. The upstream face was sloped. Conventional concrete was vibrated with the RCC to form a stepped profile on the downstream face (Figure 117). Approximately 22,940 cu m (30,000 cu yd) of RCC was placed between 6 and 21 July, 1993.

Modifications to the Cache Creek Settling Basin were completed September 8, 1993. Estimated cost for the project was \$22 million. If necessary, the weir will be raised an additional 1.8 m (6 ft) in about 25 years. In addition to solving the sedimentation problems, the new settling basin will ensure the integrity of the flood-control system and reduce the necessity for downstream dredging. Average annual benefits in flood control are estimated to be about \$2.6 million.

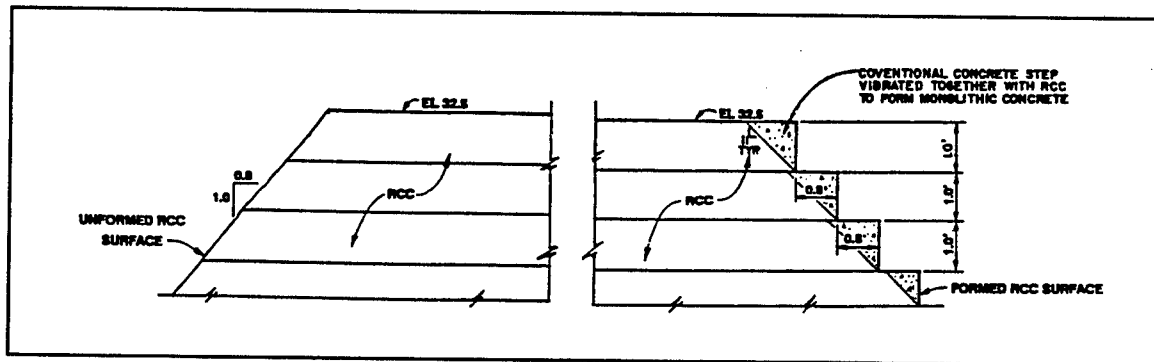

Figure 117. Upstream and downstream face details, Cache Creek Settling Basin

### 3 Conclusions and Recommendations

---

RCC is no-slump concrete in the unhardened state that is transported, placed, and compacted with earth- and rock-fill construction equipment. RCC mixtures can be proportioned to develop a wide range of properties depending on the quality of the materials used, the cementitious materials content, the extent of compaction, and the degree of control exercised. Corps of Engineers guidance on the use of RCC in dams and other civil works structures is given in EM 1110-2-2006 and ETL 1110-2-343 (Headquarters, U.S. Army Corps of Engineers 1992 and 1993). See ACI 207 (1994) for additional information on mixture proportioning, physical properties, mixing, placing, consolidation, curing, protection, testing, inspection, design, and construction of RCC.

The principal difference between RCC and conventional concrete is that RCC has a consistency that will support a vibratory roller and an aggregate grading and paste content suitable for compaction by a roller or other external methods. RCC differs from granular soil cement, which may be placed with similar methods, in that it contains coarse aggregate and develops hardened properties similar to those of conventionally placed concrete.

Although RCC was primarily developed for rapid, economical construction of new dams, the case histories reported herein show that it has been used extensively in remediation projects at existing hydraulic structures. The wide range of previous applications illustrates the versatility of RCC in repair, rehabilitation, and replacement of hydraulic structures. These applications include increasing existing spillway capacities; construction of new service, emergency, and combination spillways; repair of spillways, outlet tunnel, and lock floor; overtopping and scour protection for rock-fill timber crib and embankment dams; seismic strengthening; increasing sliding stability; breach repair; and replacement of rock-fill timber crib, earthfill embankment, and concrete dams. The basic properties of RCC (high strength, low permeability, and high erosion resistance compared to nonstabilized materials) together with low cost, rapid and relatively simple construction methods, and proven performance make it particularly attractive for remediation of hydraulic structures.

Depending on the complexity of placement and total quantity of material required, the cost of RCC typically ranges from 25 to 50 percent less than conventionally placed concrete. These savings are primarily the result of reduced costs for forming, placing, and compacting RCC. Also, the reduced construction time typical of RCC contributes significantly to its lower cost. Rapid construction is a major advantage in repair of hydraulic structures where delays and shutdowns can cause significant losses to the user. Also, rapid construction minimizes the impact of bad weather and reduces the potential for adverse environmental impact in the vicinity of project sites.

Use of RCC in repair, rehabilitation, and replacement of hydraulic structures has increased significantly in recent years, and this trend is expected to continue. The potential for application of RCC should be evaluated for all projects where no-slump concrete can be transported, placed, and compacted with construction equipment and techniques normally associated with earth- and rock-fill construction.



# References

---

ACI Committee 207. (1994). "Roller-compacted mass concrete," ACI 207.5R, *ACI Manual of Concrete Practice*, American Concrete Institute, Detroit, MI.

American Concrete Institute. (1988). "Roller compacted mass concrete," *ACI Materials Journal*, Report ACI 207.5R, Detroit, MI.

American Society for Testing and Materials. (1973). "Specification for molds for forming concrete test cylinders vertically," ASTM C 470, *1973 Annual Book of ASTM Standards*, Part 10. Philadelphia, PA, 289-293.

\_\_\_\_\_. (1975). *1975 Annual Book of ASTM Standards*, Part 14. Philadelphia, PA.

- a. ASTM C 33, "Standard specification for concrete aggregates," 14-21.
- b. ASTM C 94, "Standard specification for ready-mixed concrete," 54-65.
- c. ASTM C 150, "Standard specification for portland cement," 100-106.
- d. ASTM C 618, "Standard specification for fly ash and raw calcined natural pozzolans for use in portland cement concrete," 350-354.

\_\_\_\_\_. (1994). *1994 Annual Book of ASTM Standards*, Section 4, Volume 04.08. Philadelphia, PA.

- a. ASTM D 698, "Test method for laboratory compaction characteristics of soil using standard effort (12,400 ft-lbf/ft<sup>3</sup> (6,000 kN-m/m<sup>3</sup>)), 69-76.
- b. ASTM D 1557, "Test method for laboratory compaction characteristics of soil using modified effort (56,000 ft-lbf/ft<sup>3</sup> (2,700 kN-m/m<sup>3</sup>)), 118-125.

Anderson, F. A. (1984). "RCC does more," *Concrete International* 6(5), 35-37.

Baier, D. R. (1989). "Boney Falls Dam rehabilitation." *Proceedings from the 6th ASDSO Annual Conference*. Association of State Dam Safety Officials, Lexington, KY, 146.

- Bakeman, K. (1993). "RCC overtopping protection of two USDA Forest Service dams." *Proceedings of the 1993 Annual ASDSO Conference*. Association of State Dam Safety Officials, Lexington, KY.
- Bass, R. P. (1992). "Spillway modification utilizing roller compacted concrete." *Proceedings from the 1992 ASDSO Annual Conference*. Association of State Dam Safety Officials, Lexington, KY.
- Benson, S. A., and Hokenson, R. A. (1988). "Small r.c.c. dam plays major role in rehabilitation project," *Water Power & Dam Construction*, 40(2), 37-40.
- Benson, S. A., and Pavone, M. (1993). "RCC rehabilitation of two dams." *Proceedings of the 1993 ASDSO Annual Conference*. Association of State Dam Safety Officials, Lexington KY.
- Benson, S. A., Verigin, W. M., and Carney, M. J. (1988). "Cedar Falls roller compacted concrete dam." *Roller Compacted Concrete II, Proceedings of the conference sponsored by the Construction, Geotechnical Engineering and Materials Divisions of the American Society of Civil Engineers*. K. D. Hansen and L. K. Guice, ed., American Society of Civil Engineer, NY, 39-50.
- Bingham, W. B., and Schweiger, P. G. (1990). "Rehabilitation of Saltlick Dam: a case study in dam rehabilitation." *Proceedings of the 7th Annual ASDSO Conference*. Association of State Dam Safety Officials, Lexington, KY.
- Bischoff, J. H., and Obermeyer, J. R. (1993). "Design considerations for raising existing dams for increased storage." *Geotechnical Practice in Dam Rehabilitation, Proceedings of the Specialty Conference*. American Society of Civil Engineers, NY, 174-187.
- Bloomberg, R. (1989). "Low-cost concrete finds a new use," *ENR*, 223(15), 51-52.
- Buttrey, H. C. (1983). "Rehabilitation of TVA's Ocoee no. 2 project," *A Facsimile Report*, The United States Department of Energy, Oak Ridge, TN, 931-940.
- Calvino, M. G. (1993). "Comparing two RCC dam rehabilitation projects," *RCC Newsletter*, 9(2), 1-3.
- Calvino, M. G., and Rogers, M. F. (1994). "Structural design of roller-compacted concrete chute spillways." *1994 Annual Conference Proceedings*. Association of State Dam Safety Officials, Lexington, KY.
- Cannon, R. W. (1993). "Air-entrained roller compacted concrete," *Concrete International*, 15(5), 49-54.
- Chao, P. (Dec. 1980). "Tarbella dam—problems solved by novel concretes," *Civil Engineering*, 58-64.

- Ditchey, E. J. (1992). "Rehabilitating small earth embankments with RCC." *Roller Compacted Concrete III, Proceedings of the conference sponsored by the Construction, Geotechnical Engineering and Materials Engineering Division of the American Society of Civil Engineers*. K. D. Hansen and F. G. McLean, ed., American Society of Civil Engineers, NY, 491-505.
- Dolen, T. P. (1991). "Freezing and thawing durability of roller-compacted concrete," SP-126, *Durability of Concrete, I. CANMET/ACI Proceedings Second International Conference*. V. Malhorta, ed., American Concrete Institute, Detroit, MI, 101-113.
- ENR. (1977). "Major erosion hits Tarbella Dam again," 199(9), 37-38.
- \_\_\_\_\_. (1994). "Dams survived quake well, even one being reinforced," 232(6), 9.
- Froehlich, D. R., and Nigus, L. A. (1991). "Ashton hydroelectric project rehabilitation." *Waterpower '91 III, Proceedings of the International Conference on Hydropower*. American Society of Civil Engineers, NY, 1980-1989.
- Gehring, D. (1990). "Quail Creek RCC Dam," *Concrete International* 12(10), 35-38.
- Green, K. R. (1991). "Dryden roller-compacted concrete dam—a case history," RCC Seminar in Portland, Oregon, sponsored by Portland Cement Association, Skokie, IL.
- Hansen, K. D. (1989a). "North Fork of the Toutle River debris retention structure." *Proceedings from the 6th ASDSO Annual Conference*. Association of State Dam Safety Officials, Lexington, KY.
- \_\_\_\_\_. (1989b). "Performance of roller-compacted concrete dam rehabilitations." *Proceedings from the 6th ASDSO Annual Conference*. Association of State Dam Safety Officials, Lexington, KY.
- \_\_\_\_\_. (1993). "Using roller-compacted concrete for cost-effective dam modification," *Hydro Review* 12(2), 14-20.
- \_\_\_\_\_. (1994). "Built in the USA—RCC dams of the 1990s," *International Water Power & Dam Construction* 24(28), 25-28.
- Hansen, K. D., and France, J. W. (Sep 1986). "RCC: a dam rehab solution unearthed," *Civil Engineering* 56(9), 60-63.
- Hansen, K. D., and Reinhardt, W. G. (1991). *Roller-compacted concrete dams*. McGraw-Hill, NY.

- Headquarters, U.S. Army Corps of Engineers. (1992). "Roller-compacted concrete," EM 1110-2-2006, Washington, DC.
- \_\_\_\_\_. (1993). "Structural design using the roller-compacted concrete (RCC) construction process," ETL 1110-2-343, Washington, DC.
- Hendricks, P. A. (1989). "Santa Cruz Dam—problems and solutions." *Proceedings of the 6th ASDSO Annual Conference*. Association of State Dam Safety Officials, Lexington, KY.
- Hepler, T. E. (1992). "RCC buttress construction for Camp Dyer Diversion Dam." *Proceedings from the 1992 ASDSO Annual Conference*. Association of State Dam Safety Officials, Lexington, KY.
- Holderbaum, R. E., and Wilson, D. B. (1992). "Construction of roller-compacted concrete at Siegrist Dam." *Proceedings from the 1992 ASDSO Annual Conference*. Association of State Dam Safety Officials, Lexington, KY.
- Huq, S., and Whiting, J. (1993). "Case study on Rosebud Dam rehabilitation, Rosebud Sioux Reservation, South Dakota." *Proceedings from the 1993 ASDSO Annual Conference*. Association of State Dam Safety Officials, Lexington KY.
- Jackson, H. E., Forrest, M. P., and Hansen, K. D. (1990). "Rebuilding Quail Creek Dike with RCC." *Proceedings, 7th ASDSO Annual Conference*. Association of State Dam Safety Officials, Lexington, KY.
- Johnson, D. L., Locke, L. J., and Ortiz, P. Y. (1989). "Kemmerer City Dam." *Proceedings, 6th ASDSO Annual Conference*. Association of State Dam Safety Officials, Lexington, KY.
- Johnson, H., and Chao, P. (1979). "Rollcrete usage at Tarbela Dam," *Concrete International* 1(11), 20-33.
- Johnson, T. W., and Saber, R. T. (1991). "RCC for rehab—the Pennsylvania experience." *Association of State Dam Safety Officials Roller Compacted Concrete for Dams Conference*. Johnstown, PA.
- Lawson, M. K. (1988). "Projects spur RCC innovation," *ENR* 222(14), 24-25.
- Lemons, R. M., King, J. R., and Rutledge, J. L. (1990). "Rehabilitation of dams for planned overtopping." *Proceedings, 7th ASDSO Annual Conference*. The Association of State Dam Safety Officials, Lexington, KY.

- Marold, W. J. (1992). "Design of the Boney Falls emergency spillway." *Roller Compacted Concrete III, Proceedings of the conference sponsored by the Construction, Geotechnical Engineering and Materials Engineering Divisions of American Society of Civil Engineers*. K. D. Hansen and F. G. McLean, ed., American Society of Civil Engineers, NY, 476-489.
- Metcalf, M., Dolen, T., and Hendricks, P. (1992). "Santa Cruz Dam modification." *Roller Compacted Concrete III, Proceedings of the conference sponsored by the Construction, Geotechnical Engineering and Materials Engineering Divisions of American Society of Civil Engineers*. K. D. Hansen and F. G. McLean, ed., American Society of Civil Engineers, NY, 459-475.
- Morsman, D. E., Lawler, L. E., and Seimears, J. R. (1985). "Construction of two spillways using roller compacted concrete." *Roller Compacted Concrete, Proceedings of the Symposium sponsored by the Colorado Section and Construction Division of the American Society of Civil Engineers in conjunction with ASCE Convention in Denver, Co.* K. D. Hansen, American Society of Civil Engineers, NY, 62-70.
- Munn, W. D. (1988). "Sloping roller concrete faces earthfill dams," *Highway and Heavy Construction*, 131(9), 60-62, Cahners Publications, Denver, CO.
- Newell, V. A., Manson, H. A., Wagner, C. D. (1991). "Dam safety rehabilitation of the T.V.A. Nickajack Hydroelectric Project." *Waterpower '91 II, Proceedings of the conference sponsored by the Construction, Geotechnical Engineering and Materials Engineering Divisions of the American Society of Civil Engineers*. David D. Darling, ed., American Society of Civil Engineers, 1358-1367.
- RCC Newsletter*. (1986). "Overflow structures and spillways," 3, Portland Cement Association, Skokie IL.
- \_\_\_\_\_. (1987). "Spring Creek Dam," 5, Portland Cement Association, Skokie, IL.
- \_\_\_\_\_. (1988). "Unsafe earth dams rehabilitated with RCC," 6, Portland Cement Association, Skokie, IL.
- \_\_\_\_\_. (1989a). "RCC replaces timber crib dam," 9, Portland Cement Association, Skokie, IL.
- \_\_\_\_\_. (1989b). "TVA rehabilitates dam with RCC," 8, Portland Cement Association, Skokie, IL.
- \_\_\_\_\_. (1990). "Upper Michigan dam rehabilitated with RCC," 6(1), Portland Cement Association, Skokie, IL.

- RCC Newsletter*. (1993). "Strengthened dam withstands quake," 9(2), Portland Cement Association, Skokie, IL.
- Reeves, G.N. (1985). "Planned overtopping of embankments using roller compacted concrete." *Proceedings of the ASCE 1985 National Conference on Hydraulics and Hydrology in the Small Computer Age*. 2, 1077-1081, Orlando, FL.
- Reeves, G. N., and Yates, L. B. (1985). "Simplified design and construction control for roller compacted concrete." *Proceedings of the symposium sponsored by the Colorado Section and Construction Division of the American Society of Civil Engineers in conjunction with the ASCE Convention in Denver, Colorado*. American Society of Civil Engineers, 56-57.
- Reynolds, R. D., Joyet, R. A., and Curtis, M. O. (1993). "Victoria Dam rehabilitation." *Waterpower '93, Proceedings of International Conference on Hydropower*. W. Daniel Hall, ed., American Society of Civil Engineers, NY.
- Rogers, M. F., and Calvino, M. G. (1992). "Rehabilitation of The Rosebud Sioux Indian Tribe dams." *Proceedings of the 1992 ASDSO Annual Conference*. Association of State Dam Safety Officials, Lexington, KY.
- Rutledge, J., and King, R. (1994). "Rehabilitation of the South Prong Dam." *RCC Seminar, Arlington, TX*, sponsored by Portland Cement Association, Skokie, IL.
- \_\_\_\_\_. (1995). "Rehabilitation of South Prong Dam," *RCC Newsletter* 11(1), Portland Cement Association, Skokie, IL.
- Sert, S. (1993). "Construction of Marmot RCC dam," *Concrete International*, 15(8), 44-46.
- Smith, Lorraine. (1986). "RCC dam survives Texas flood," *ENR* 216(17), 28-29.
- Throckmorton, J. E., and Knarr, C. M. (1991). "Bishop Intake #2 spillway modifications: A case history." *Waterpower '91 III, Proceedings on the International Conference on Hydropower*. David D. Darling, ed., American Society of Civil Engineers, NY, 1378-1387.
- U.S. Bureau of Reclamation; U.S. Department of the Interior. (1985). "Field permeability test (shallow-well permeameter method)," Designation E-36, *Earth Manual, a Water Resources Technical Publication*, U.S. Government Printing Office, Denver.

- Wong, N. C., Feldsher, T. B., Wright, R. S., and Johnson, D. H. (1992). "Final design and construction of Gibraltar Dam strengthening," *Roller Compacted Concrete III, Proceedings of the conference sponsored by the Construction, Geotechnical Engineering and Materials Engineering Division of the American Society of Civil Engineers*. K. D. Hansen and F. G. McLean, ed., American Society of Civil Engineers, NY, 440-458.
- Wong, N. C., Forrest, M. P., and Lo, S. H. (1993). "Littlerock Dam rehabilitation, another RCC innovation." *Proceedings from the 1993 ASDSO Annual Conference*. Association of State Dam Safety Officials, Lexington, KY.
- Zovne, J. (1989). "Reducing the cost of dam safety upgrades." *Proceedings of the 6th ASDSO Annual Conference*. Association of State Dam Safety Officials, Lexington, KY.

# REPORT DOCUMENTATION PAGE

Form Approved  
OMB No. 0704-0188

Public reporting burden for this collection of information is estimated to average 1 hour per response, including the time for reviewing instructions, searching existing data sources, gathering and maintaining the data needed, and completing and reviewing the collection of information. Send comments regarding this burden estimate or any other aspect of this collection of information, including suggestions for reducing this burden, to Washington Headquarters Services, Directorate for Information Operations and Reports, 1215 Jefferson Davis Highway, Suite 1204, Arlington, VA 22202-4302, and to the Office of Management and Budget, Paperwork Reduction Project (0704-0188), Washington, DC 20503.

<b>1. AGENCY USE ONLY (Leave blank)</b>	<b>2. REPORT DATE</b> April 1997	<b>3. REPORT TYPE AND DATES COVERED</b> Final report	
<b>4. TITLE AND SUBTITLE</b> Applications of Roller-Compacted Concrete in Rehabilitation and Replacement of Hydraulic Structures		<b>5. FUNDING NUMBERS</b>  Civil Works Research Work Unit 32639	
<b>6. AUTHOR(S)</b> James E. McDonald, Nancy F. Curtis		<b>8. PERFORMING ORGANIZATION REPORT NUMBER</b> Technical Report REMR-CS-53	
<b>7. PERFORMING ORGANIZATION NAME(S) AND ADDRESS(ES)</b> U.S. Army Engineer Waterways Experiment Station 3909 Halls Ferry Road Vicksburg, MS 39180-6199		<b>10. SPONSORING/MONITORING AGENCY REPORT NUMBER</b>	
<b>9. SPONSORING/MONITORING AGENCY NAME(S) AND ADDRESS(ES)</b> U.S. Army Corps of Engineers Washington, DC 20314-1000		<b>11. SUPPLEMENTARY NOTES</b> Available from National Technical Information Service, 5285 Port Royal Road, Springfield, VA 22161.	
<b>12a. DISTRIBUTION/AVAILABILITY STATEMENT</b> Approved for public release; distribution is unlimited.		<b>12b. DISTRIBUTION CODE</b>	
<b>13. ABSTRACT (Maximum 200 words)</b> <p>Although roller-compacted concrete (RCC) was primarily developed for rapid, economical construction of new dams, the case histories reported herein show that it has been used extensively in remediation projects at existing hydraulic structures. These case histories were compiled to illustrate the versatility of RCC in repair, rehabilitation, and replacement of hydraulic structures. RCC applications include increasing existing spillway capacities; construction of new service, emergency, and combination spillways; repair of spillways, outlet tunnel, and lock floor; overtopping and scour protection for rock-fill timber crib and embankment dams; seismic strengthening; increasing sliding stability; breach repair; and replacement of rock fill timber crib, earthfill embankment, and concrete dams. The basic properties of RCC (high strength, low permeability, and high erosion resistance compared to nonstabilized materials) together with low cost, rapid and relatively simple construction methods, and proven performance make it particularly attractive for remediation of hydraulically deficient embankment dams.</p> <p>Depending on the complexity of placement and total quantity of material required, the cost of RCC typically ranges from 25 to 50 percent less than conventionally placed concrete. These savings are primarily the result of reduced costs for forming, placing, and compacting RCC. Also, the reduced construction time typical of RCC contributes significantly to its lower cost. Rapid construction is a major advantage in repair of hydraulic structures where delays and shutdowns can cause significant losses to the user. Also, rapid construction minimizes the impact of bad weather and reduces the potential for adverse environment impact in the vicinity of project sites.</p>			
<b>14. SUBJECT TERMS</b> Case histories                      Hydraulic structures                      Roller-compacted concrete Concrete structures                Rehabilitation Construction                         Repair		<b>15. NUMBER OF PAGES</b> 184	<b>16. PRICE CODE</b>
<b>17. SECURITY CLASSIFICATION OF REPORT</b> UNCLASSIFIED	<b>18. SECURITY CLASSIFICATION OF THIS PAGE</b> UNCLASSIFIED	<b>19. SECURITY CLASSIFICATION OF ABSTRACT</b>	<b>20. LIMITATION OF ABSTRACT</b>