

# RECLAMATION

*Managing Water in the West*

Design Standards No. 14

## **Appurtenant Structures for Dams (Spillways and Outlet Works) Design Standard**

**Chapter 3: General Spillway Design Considerations  
Final: Phase 4**



## **Mission Statements**

The U.S. Department of the Interior protects America's natural resources and heritage, honors our cultures and tribal communities, and supplies the energy to power our future.

The mission of the Bureau of Reclamation is to manage, develop, and protect water and related resources in an environmentally and economically sound manner in the interest of the American public.

**Design Standards Signature Sheet**

**Design Standards No. 14**

# **Appurtenant Structures for Dams (Spillways and Outlet Works) Design Standard**

**DS-14(3)-1: Final: Phase 4  
February 2022**

**Chapter 3: General Spillway Design Considerations**

# Revision Number DS-14(3)-1

---

## Summary of revisions:

- Revised bearing capacity safety factor equation in section 3.8.3.2 page 140

### Prepared by:

**ERNEST HALL** Digitally signed by ERNEST HALL  
Date: 2022.03.11 08:48:48 -07'00'

---

Ernest Hall, P.E.  
Design Standard Team Leader

---

Date

### Peer Review:



Digitally signed by ADAM  
TOOTHMAN  
Date: 2022.03.11 08:58:05 -07'00'

---

Adam Toothman, P.E.  
Supervisory Civil Engineer, Waterways and Concrete  
Dams 3

---

Date

### Submitted:

**ERNEST HALL** Digitally signed by ERNEST HALL  
Date: 2022.03.21 07:14:33 -06'00'

---

Ernest Hall, P.E.  
Chief, Civil Engineering Services Division 2

---

Date

### Approved:

**RICHARD LAFOND** Digitally signed by RICHARD LAFOND  
Date: 2022.06.29 09:48:32 -06'00'

---

Richard LaFond, P.E.  
Director, Technical Service Center

---

Date



# Foreword

## Purpose

The Bureau of Reclamation (Reclamation) design standards present technical requirements and processes to enable design professionals to prepare design documents and reports necessary to manage, develop, and protect water and related resources in an environmentally and economically sound manner in the interest of the American public. Compliance with these design standards assists in the development and improvement of Reclamation facilities in a way that protects the public's health, safety, and welfare; recognizes needs of all stakeholders; and achieves lasting value and functionality necessary for Reclamation facilities. Responsible designers accomplish this goal through compliance with these design standards and all other applicable technical codes, as well as incorporation of the stakeholders' vision and values, that are then reflected in the constructed facilities.

## Application of Design Standards

Reclamation design activities, whether performed by Reclamation or by a non-Reclamation entity, must be performed in accordance with established Reclamation design criteria and standards, and approved national design standards, if applicable. Exceptions to this requirement shall be in accordance with provisions of *Reclamation Manual Policy*, Performing Design and Construction Activities, FAC P03.

In addition to these design standards, designers shall integrate sound engineering judgment, applicable national codes and design standards, site-specific technical considerations, and project-specific considerations to ensure suitable designs are produced that protect the public's investment and safety. Designers shall use the most current edition of national codes and design standards consistent with Reclamation design standards. Reclamation design standards may include exceptions to requirements of national codes and design standards.

## Deviations and Proposed Revisions

Reclamation designers should inform the Technical Service Center (TSC), via Reclamation's Design Standards Website notification procedure, of any recommended updates or changes to Reclamation design standards to meet current and/or improved design practices.



**Chapter Signature Sheet  
Bureau of Reclamation  
Technical Service Center**

**Design Standards No. 14**

# **Appurtenant Structures for Dams (Spillways and Outlet Works) Design Standard**

## **Chapter 3: General Spillway Design Considerations**

**DS-14(3)-1:<sup>1</sup> Final: Phase 4  
February 2022**


Design Standards No. 14 is a new document. Chapter 3 of this Design Standards was developed to provide:

- Technical processes for evaluating existing spillways and selecting the type and size of spillway modifications for existing dams
- Technical processes for selecting the type, location, and size of a new spillway for existing and/or new dams
- A list of key technical references for evaluating existing spillways and selecting the type, location, and size of a spillway for existing and/or new dams

---


<sup>1</sup> DS-14(3)-1 refers to Design Standards No. 14, chapter 3, revision 1.

**Prepared by:**

  
\_\_\_\_\_  
John LaBoon, P.E.  
Design Standard Team Leader, Waterways and Concrete  
Dams Group


7/15/2014  
Date

**Technical Approval:**

  
\_\_\_\_\_  
Robert McGovern, P.E.  
Civil Engineer, Waterways and Concrete Dams Group

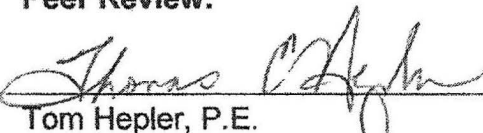
8/1/2014  
Date

**Security Review:**

  
\_\_\_\_\_  
Phoebe Percell, P.E.  
Group Manager, Structural Analysis Group

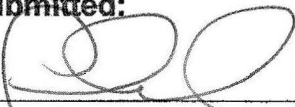
30 JULY 2014  
Date

**Peer Review:**

  
\_\_\_\_\_  
Tom Hepler, P.E.  
Technical Specialist, Waterways and Concrete Dams  
Group (RETIRED)


7/29/2014  
Date

**Submitted:**

  
\_\_\_\_\_  
Richard LaFond, P.E.  
Chief, Civil Engineering Services Division

8/10/14  
Date

**Approved:**

  
\_\_\_\_\_  
Thomas A. Luebke, P.E.  
Director, Technical Service Center

8/11/14  
Date

# Acronyms and Abbreviations

ACER	Assistance Commissioner - Engineering and Research
ACI	American Concrete Institute
ASCE	American Society of Civil Engineers
ASR	alkali-silica-reaction
BIA	Bureau of Indian Affairs
CDF	computational fluid dynamics
CJ	construction joint
CrJ	contraction joint
CtJ	control joint
DBE	design basis earthquake
DM	decision memorandum
EJ	expansion joint
EM	Engineering Manual or monograph
F	formed concrete surface
FEM	Finite Element Model
IDF	Inflow Design Flood
M&I	municipal and industrial
M-O	Mononobe-Okabe
OVIC	Ongoing Visual Inspection Checklist
PC	point of curvature
PFM	potential failure mode
PHA	peak horizontal acceleration
PMF	Probable Maximum Flood
PT	point of tangency
PVC	polyvinyl chloride
RCA	reservoir capacity allocation
RCC	roller compacted concrete
Reclamation	Bureau of Reclamation
RWS	reservoir water surface
SOP	Standing Operating Procedures
SSD	saturated surface dry
TSC	Technical Service Center
TM	Technical memorandum or technical manual
U	unformed concrete surface
USCS	Unified Soil Classification System



# Contents

	<i>Page</i>
3.1	Scope..... 3-1
3.2	Definitions and Concepts..... 3-1
3.2.1	Spillways..... 3-2
3.2.1.1	Service Spillway..... 3-2
3.2.1.2	Auxiliary Spillway ..... 3-2
3.2.1.3	Emergency Spillway ..... 3-2
3.2.2	Dams ..... 3-5
3.2.2.1	Concrete Dams ..... 3-10
3.2.2.2	Embankment Dams ..... 3-11
3.2.2.3	Composite Dams ..... 3-11
3.3	Function ..... 3-11
3.3.1	General..... 3-11
3.3.2	Checklist and Procedure – Spillway Design..... 3-12
3.3.2.1	Checklist ..... 3-15
3.3.2.2	Procedure ..... 3-16
3.3.3	Relationship Between Reservoir Storage and Spillway Discharge Capacity..... 3-17
3.3.4	Spillway Configuration ..... 3-18
3.4	Design Floods ..... 3-20
3.4.1	Inflow Design Flood ..... 3-21
3.4.2	Construction Diversion Floods..... 3-21
3.5	Spillway Location, Type, and Size..... 3-21
3.5.1	Spillway Location..... 3-21
3.5.1.1	Dam Abutments..... 3-22
3.5.1.2	Reservoir Rim..... 3-22
3.5.1.3	Over or Through a Dam..... 3-22
3.5.1.4	Spillway Foundations..... 3-23
3.5.2	Spillway Type and Size..... 3-23
3.5.2.1	Uncontrolled Spillways..... 3-23
3.5.2.2	Controlled Spillways..... 3-43
3.5.2.3	Spillway Types Summary..... 3-54
3.5.2.4	Considerations for Selecting Spillway Type and Size..... 3-57
3.5.2.5	Procedure for Selecting Spillway Type and Size..... 3-58
3.5.3	Examples..... 3-59
3.6	General Hydraulic Considerations ..... 3-60
3.6.1	Discharge Capacity ..... 3-60
3.6.1.1	Crest Control (Uncontrolled or Free Flow) ..... 3-60
3.6.1.2	Orifice Control (Controlled Flow) ..... 3-62
3.6.1.3	Pipe Control (Pressurized Flow) ..... 3-64
3.6.1.4	Multiple Hydraulic Controls..... 3-65

- 3.6.1.5 Discharge Capacity Design Procedures..... 3-66
- 3.6.1.6 Existing Spillways..... 3-70
- 3.6.1.7 New Spillways..... 3-71
- 3.6.2 Flood Routing..... 3-72
  - 3.6.2.1 Current Data ..... 3-72
  - 3.6.2.2 Starting RWS..... 3-73
  - 3.6.2.3 Starting Time ..... 3-73
  - 3.6.2.4 Time Increments..... 3-74
  - 3.6.2.5 Complete Routings..... 3-74
  - 3.6.2.6 Robustness (Freeboard) Study..... 3-74
- 3.6.3 Reservoir Evacuation and First Filling ..... 3-74
  - 3.6.3.1 Current Data ..... 3-75
  - 3.6.3.2 Starting RWS..... 3-75
  - 3.6.3.3 Hydrology..... 3-77
- 3.6.4 Other Hydraulics ..... 3-77
  - 3.6.4.1 Conveyance Feature..... 3-77
  - 3.6.4.2 Terminal Structure ..... 3-90
  - 3.6.4.3 Erosion Protection..... 3-95
- 3.7 General Foundation Considerations..... 3-99
  - 3.7.1 Elastic Foundation..... 3-99
  - 3.7.2 Foundation Design ..... 3-101
    - 3.7.2.1 Foundation Treatment..... 3-101
    - 3.7.2.2 Foundation Acceptance..... 3-116
  - 3.7.3 Drainage and Insulation ..... 3-119
    - 3.7.3.1 Drainage..... 3-120
    - 3.7.3.2 Insulation ..... 3-125
- 3.8 General Structural Considerations..... 3-127
  - 3.8.1 Loading Conditions..... 3-128
  - 3.8.2 Seismic (Earthquake) Loads..... 3-134
  - 3.8.3 Stability Design ..... 3-138
    - 3.8.3.1 Loading Combinations..... 3-138
    - 3.8.3.2 Stability Conditions..... 3-139
  - 3.8.4 Reinforced Concrete Design..... 3-142
    - 3.8.4.1 Strength Design ..... 3-143
    - 3.8.4.2 Loads..... 3-144
    - 3.8.4.3 Load Combinations..... 3-144
    - 3.8.4.4 Load Factors ..... 3-145
    - 3.8.4.5 Strength Reduction Factors ( $\phi$ ) ..... 3-145
    - 3.8.4.6 Serviceability Considerations for Hydraulic Structures ..... 3-146
    - 3.8.4.7 New Concrete and Reinforcement Properties ..... 3-146
    - 3.8.4.8 Existing Concrete and Reinforcement Properties ..... 3-147



	<i>Page</i>
3.8.5	Reinforcement ..... 3-147
3.8.6	Joints, Waterstops, and Tolerances ..... 3-148
3.8.6.1	Joints ..... 3-148
3.8.6.2	Waterstops ..... 3-164
3.8.6.3	Tolerances..... 3-166
3.9	General Electrical/Mechanical Considerations..... 3-171
3.9.1	Mechanical Features..... 3-172
3.9.1.1	Gates..... 3-172
3.9.1.2	Bulkheads ..... 3-176
3.9.1.3	Stoplogs ..... 3-178
3.9.1.4	Flashboards..... 3-180
3.9.2	Operating Systems..... 3-181
3.10	Instrumentation and Monitoring ..... 3-182
3.11	Technical References ..... 3-183
3.12	References..... 3-185

## Tables

<i>Table</i>	<i>Page</i>
3.3.2-1	Procedure for spillway design using quantitative risk analysis methodology ..... 16
3.5.2.3-1	Spillway type summary ..... 55
3.5.2.4-1	Considerations for selecting spillway type and size ..... 58
3.5.2.5-1	Procedure for selecting spillway type and size ..... 59
3.6.1.5-1	Procedure for estimating discharge capacity of a spillway for crest control conditions..... 67
3.6.1.5-2	Procedure for estimating discharge capacity of a spillway for orifice control conditions..... 68
3.6.1.5-3	Procedure for estimating discharge capacity of a spillway for pipe control conditions..... 69
3.8.3.2-1	Minimum safety factors ..... 142
3.8.6.1.6-1	Concrete joints associated with spillway features..... 162
3.8.6.3-1	Surface tolerances ( $T_S$ ) ..... 169
3.8.6.3.5-1	Procedure for selecting surface tolerances ( $T_S$ )..... 171

# Figures

<i>Figure</i>		<i>Page</i>
3.2.1.1-1	Service spillways, from top to bottom: Pineview Dam, Utah; Monticello Dam, California; Echo Dam, Utah; and Upper Stillwater Dam, Utah.....	3-3
3.2.1.2-1	Auxiliary spillways, from top to bottom: Heart Butte Dam, North Dakota; Gibson Dam, Montana; New Waddell Dam, Arizona; and Stewart Mountain Dam, Arizona. ....	3-4
3.2.1.3-1	Emergency spillways, from top to bottom: Folsom Dam, California, and San Justo Dam, California.....	3-6
3.2.2-1	RCA example. ....	3-7
3.3.4-1	Spillway configuration – Common features.....	3-19
3.5.2-1	Spillway type chart.....	3-25
3.5.2.1-1	Chute (baffled apron) spillway.....	3-27
3.5.2.1-2	Chute (grade control sill) spillway.....	3-28
3.5.2.1-3	Chute (stepped chute) spillway. ....	3-29
3.5.2.1-4	Drop inlet (morning glory) spillway.....	3-30
3.5.2.1-5	Bathtub spillway.....	3-33
3.5.2.1-6	Side-channel spillway.....	3-34
3.5.2.1-7	Free overfall (ogee crest) spillway – Integrated with concrete dam. ....	3-36
3.5.2.1-8	Labyrinth weir spillway.....	3-38
3.5.2.1-9	Ogee crest spillway.....	3-39
3.5.2.1-10	Overtopping protection spillway.....	3-41
3.5.2.1-11	Culvert spillway. ....	3-43
3.5.2.2-1	Fuseplug spillway. ....	3-45
3.5.2.2-2	Fusegate spillway.....	3-47
3.5.2.2-3	Gated (ogee crest) spillway – drum gates.....	3-49
3.5.2.2-5	Tunnel inlet (gated) spillway.....	3-51
3.5.2.2-6	Gated (orifice) spillway. ....	3-53
3.5.2.2-7	Siphon spillway.....	3-54
3.5.2.4-1	Comparison (200-foot crest length) – discharge capacities of uncontrolled spillways versus space (footprint) requirements.....	3-57
3.6.1.1-1	Crest control. ....	3-61
3.6.1.2-1	Orifice control. ....	3-63
3.6.1.3-1	Pipe control.....	3-65
3.6.1.5-1	Discharge curve – Multiple hydraulic controls [2]. ....	3-70
3.6.4.1.1-1	Cavitation simulation: (left) cavitation created in Reclamation’s low ambient pressure chamber: (right) cavitation damage noted after the test. ....	3-79
3.6.4.1.1-2	1983 Spillway operations resulted in significant cavitation damage – Glen Canyon Dam, Arizona.....	3-79
3.6.4.1.2-1	Freeboard.....	3-82

## Figures (continued)

<i>Figure</i>	<i>Page</i>
3.6.4.1.4-1	Parabolic vertical curve illustration. .... 3-85
3.6.4.1.4-2	Superelevation illustration. .... 3-88
3.6.4.1.5-1	Stagnation pressure (hydraulic jacking). .... 3-90
3.6.4.2-1	Terminal structures. .... 3-92
3.6.4.2.3-1	Trajectory of a free jet illustration. .... 3-95
3.6.4.3-1	Erosion potential – erodibility index versus stream power [33]. .... 3-97
3.7.2.1.1-1	Cleaning and treatment of rock foundation [39]. .... 3-103
3.7.2.1.2-1	Slush grouting. .... 3-105
3.7.2.1.2-2	Dental concrete. .... 3-106
3.7.2.1.2-3	Beveled surfaces to eliminate feathered edges [39]. .... 3-107
3.7.2.1.3-2	Ring or pressure grouting. .... 3-110
3.7.2.1.3-1	Backfill grouting. .... 3-110
3.7.2.1.5-1	Anchor bars. .... 3-113
3.7.2.1.5-2	Rock bolts. .... 3-114
3.7.2.1.5-3	Post-tensioned anchors. .... 3-115
3.7.2.1.5-4	Cutoffs. .... 3-117
3.7.3.1-1	Drainage. .... 3-121
3.7.3.1-2	Drainage access – outside longitudinal collectors. .... 3-122
3.7.3.1-3	Drainage access – inside longitudinal collectors. .... 3-123
3.7.3.1-4	Air supply/demand. .... 3-126
3.7.3.2-1	Insulation. .... 3-127
3.8.1-1	Concrete temperature history. .... 3-130
3.8.6.1.1-1	CJ orientation (horizontal, vertical, and diagonal). .... 3-150
3.8.6.1.2-1	Transverse CrJs without foundation keys for flow surface slabs. .... 3-152
3.8.6.1.2-2	Transverse CrJs with foundation keys for flow surface slabs. .... 3-153
3.8.6.1.2-3	Longitudinal CrJs for flow surface slabs and transverse CrJs for flow surface walls. .... 3-154
3.8.6.1.3-1	Transverse CtJs without foundation keys for flow surface slabs. .... 3-156
3.8.6.1.3-2.	Transverse CtJs with foundation keys for flow surface slabs. .... 3-157
3.8.6.1.3-3	Longitudinal CtJs for flow surface slabs and transverse CtJs and CJs for flow surface conduits and tunnels. .... 3-158
3.8.6.1.4-1	Surface delamination near joints. .... 3-160
3.8.6.1.5-1	Expansion joints (EJs). .... 3-161
3.8.6.2-1	Retrofit and strip waterstops. .... 3-166
3.8.6.3-1	Surface roughnesses. .... 3-168
3.8.6.3-2	Measuring surface roughnesses. .... 3-168
3.9.1.1-1	Radial gates. .... 3-173

## Figures (continued)

<i>Figure</i>		<i>Page</i>
3.9.1.1-2	Wheel-mounted gates. ....	3-173
3.9.1.1-3	Drum gates.....	3-174
3.9.1.1-4	Crest gate – bascule type. ....	3-175
3.9.1.1-5	Crest gate – Obermeyer type.....	3-175
3.9.1.2-1	Bulkhead.....	3-177
3.9.1.3-1	Stoplogs. ....	3-179
3.9.1.4-1	Flashboards – Shasta Dam spillway. ....	3-181

## Appendices

### *Appendix*

- A Examples: Spillway Location, Type, and Size
- B Potential Failure Modes (PFMs) for Spillways

## Chapter 3

# General Spillway Design Considerations

## 3.1 Scope

Design Standards No. 14, *Appurtenant Structures for Dams (Spillways and Outlet Works)* provides technical guidance concerning the Bureau of Reclamation's (Reclamation) procedures and considerations for analyzing and designing two key types of appurtenant structures associated with storage and/or multipurpose dams and/or dikes. These appurtenant structures are spillways and outlet works. Chapter 3 provides technical processes for evaluating existing spillways, along with selecting, locating, and sizing new spillways. The reader is directed to Section 3.3.2, "Checklist and Procedures – Spillway Design," of this chapter, which summarizes these technical processes. These processes should be followed by Reclamation staff and others involved with analyzing and designing spillways. These processes are used for all design activities such as appraisal, feasibility, and final design levels [1].<sup>1</sup> Specifically, chapter 3 provides general spillway design considerations applicable to both existing and new dams. Unless highlighted, this chapter is applicable to the evaluation, analysis, and design of lined (primarily with reinforced concrete), high velocity, and high flow spillways. Evaluation, analysis, and design of unlined (earthen) spillways are not considered in this chapter.<sup>2</sup> Also, the general spillway design considerations are integral with the selection of the Inflow Design Flood (IDF)<sup>3</sup> that is addressed in Chapter 2, "Hydrologic Considerations," in this design standard. Finally, it should be stressed that this design standard will minimize duplication of other existing technical references and, wherever possible, it will reference existing procedures and considerations that should be used for the analysis and design of spillways.

## 3.2 Definitions and Concepts

The following definitions and concepts are provided to clarify and explain the terminology used in this design standard. These definitions and concepts are consistent with other technical references used by Reclamation.

---

<sup>1</sup> Numbers in brackets [ ] refer to references at the end of this chapter.

<sup>2</sup> For design of unlined earthen spillways, refer to the *National Engineering Handbook*, Chapter 50, "Earth Spillway Design" [2].

<sup>3</sup> For most storage and/or multipurpose dams, selection of the IDF will be based on a quantitative risk analysis (for IDF selection process, see Chapter 2, "Hydrologic Considerations," in this design standard. The IDF will be less than or equal to the current critical Probable Maximum Flood (PMF).

### **3.2.1 Spillways**

A spillway is a hydraulic structure that passes normal (operational) and/or flood flows in a manner that protects the structural integrity of the dam and/or dikes. Spillways are hydraulically sized to safely pass floods equal to or less than the IDF. The IDF will be equal to or less than the current critical Probable Maximum Flood (PMF).<sup>4</sup> For more details and guidance about floods, refer to Chapter 2, “Hydrologic Considerations,” in this design standard.

There are three classifications of spillways typically employed by Reclamation, which are based on frequency of use. They are explained in more detail in the following sections.

#### **3.2.1.1 Service Spillway**

A service spillway provides continuous, or frequent regulated, or staged releases<sup>5</sup> (controlled) or unregulated (uncontrolled) releases from a reservoir without significant damage to the dam, dike, or appurtenant structures due to releases up to and including the maximum design discharge. Service spillways are typically very robust, erosion-resistant structures consisting of mostly cast-in-place reinforced concrete and riprap channel protection. Some examples of service spillways are illustrated in figure 3.2.1.1-1.

#### **3.2.1.2 Auxiliary Spillway**

An auxiliary spillway is infrequently used and may be a secondary spillway (augmenting a service spillway discharge capacity). During operation there could be some degree of structural damage or erosion to the auxiliary spillway due to releases up to and including the maximum design discharge. Auxiliary spillways may be less robust, erosion-resistant structures consisting of some cast-in-place reinforced concrete, riprap channel protection and/or unarmored excavated channels. Some examples of auxiliary spillways are illustrated in figure 3.2.1.2-1.

#### **3.2.1.3 Emergency Spillway**

An emergency spillway is designed to provide additional protection against overtopping of a dam and/or dike and is intended for use under unusual or extreme conditions such as misoperation or malfunction of the service spillway or outlet works during very large, remote floods (such as the PMF), or other

---

<sup>4</sup> The PMF is the largest flood that may reasonably be expected to occur at a given maximum runoff condition resulting from the most severe combination of meteorological and hydrologic conditions that are considered reasonably possible for the drainage basin under study. It should be noted that more than one type of PMF can occur at a given dam site (rain-on-snow, thunderstorm, etc.), which leads to an important concept: the critical PMF. This flood event is defined as the PMF that would typically result in the highest maximum reservoir water surface (RWS).

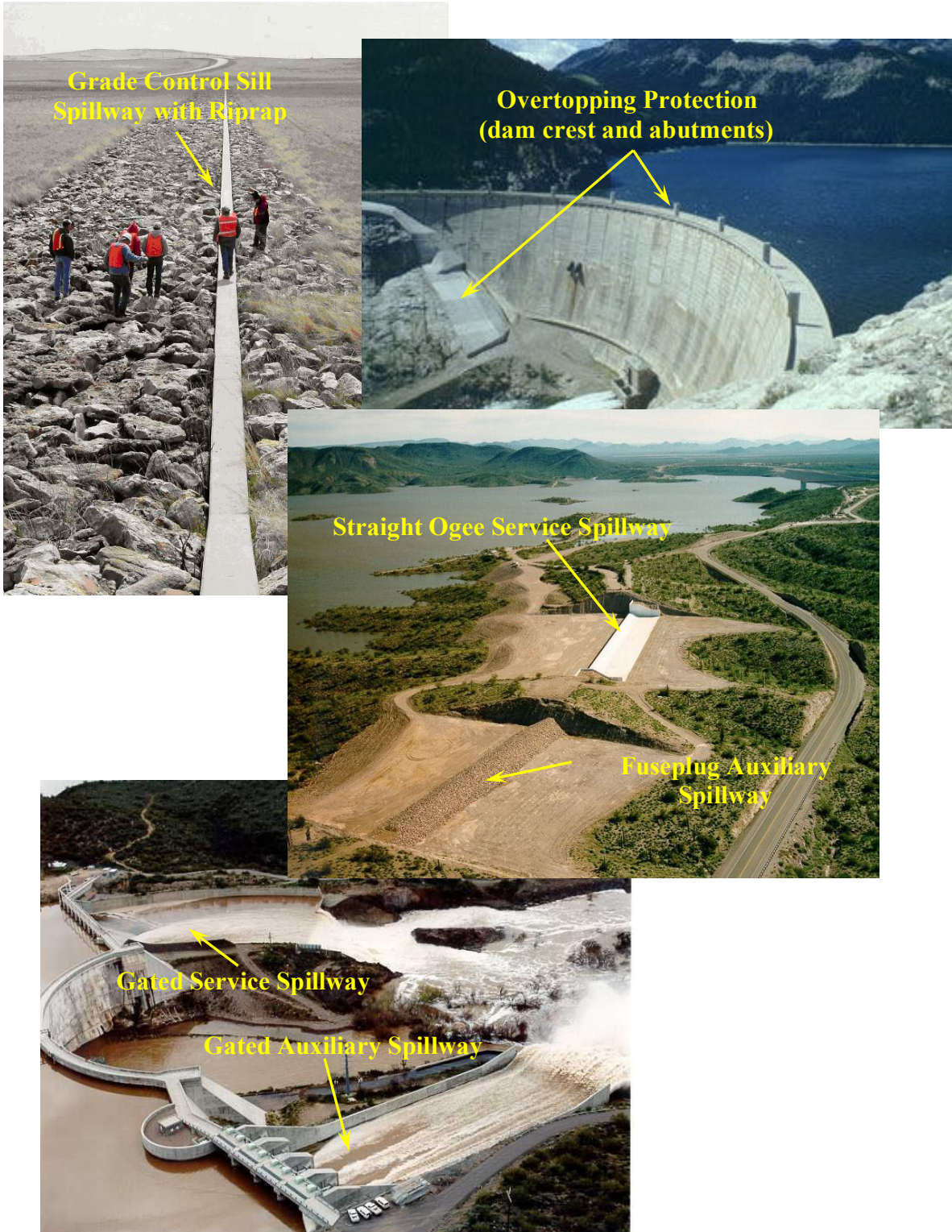
<sup>5</sup> Although the term “staged releases” can be used for other situations/applications, in this design standard, staged releases are associated with planed amounts of discharge being released once a RWS is reached or exceeded. Fuseplug, fusegate, and siphon spillways are associated with staged releases.



Figure 3.2.1.1-1. Service spillways, from top to bottom: Pineview Dam, Utah; Monticello Dam, California; Echo Dam, Utah; and Upper Stillwater Dam, Utah.



**Design Standards No. 14: Appurtenant Structures for Dams  
(Spillways and Outlet Works)**



**Figure 3.2.1.2-1. Auxiliary spillways, from top to bottom: Heart Butte Dam, North Dakota; Gibson Dam, Montana; New Waddell Dam, Arizona; and Stewart Mountain Dam, Arizona.**



emergency conditions. As with auxiliary spillways, some degree of structural damage and/or erosion may be expected due to releases up to and including the maximum design discharge. Emergency spillways are the least robust, erosion-resistant structures consisting of some cast-in-place reinforced concrete, riprap channel protection, and/or unarmored excavated channels. Some examples of emergency spillways are illustrated in figure 3.2.1.3-1.

### 3.2.2 Dams

The primary focus of this chapter involves spillways associated with storage and multipurpose dams, rather than detention<sup>6</sup> and diversion<sup>7</sup> dams. However, there may be similar hydraulic structures associated with other types of dams. The purpose of storage and multipurpose dams is to impound water during periods of surplus supply for use during periods of deficient supply. The uses of the stored water at Reclamation facilities include: irrigation, municipal and industrial (M&I), recreation, fish and wildlife, hydroelectric power generation, and other purposes. When power generation comes into play, the multipurpose dam may be designated as a forebay dam<sup>8</sup> (such as Reclamation's Banks Lake impounded by North and Dry Falls Dams) or an afterbay dam<sup>9</sup> (such as Reclamation's Olympus and Flatiron Dams). The uses of the stored water are based on the official (authorized) reservoir capacity allocation (RCA) purposes. Use of the RCA is further discussed in Section 3.3.3, "Relationship Between Reservoir Storage and Spillway Discharge Capacity," in this chapter. Also, figure 3.2.2-1 shows an example RCA sheet.

**Storage definitions** associated with the RCA and reservoir operations for a given storage and multipurpose dam follow:

- **Freeboard.** – The vertical distance between a stated reservoir water level and the crest of a dam, without camber.
- **Surcharge capacity.** – The reservoir capacity provided for use in passing the IDF through the reservoir. It is the temporary storage between the maximum RWS elevation and the highest of the following elevations: top of exclusive flood control capacity, top of joint use capacity, or top of active conservation capacity.

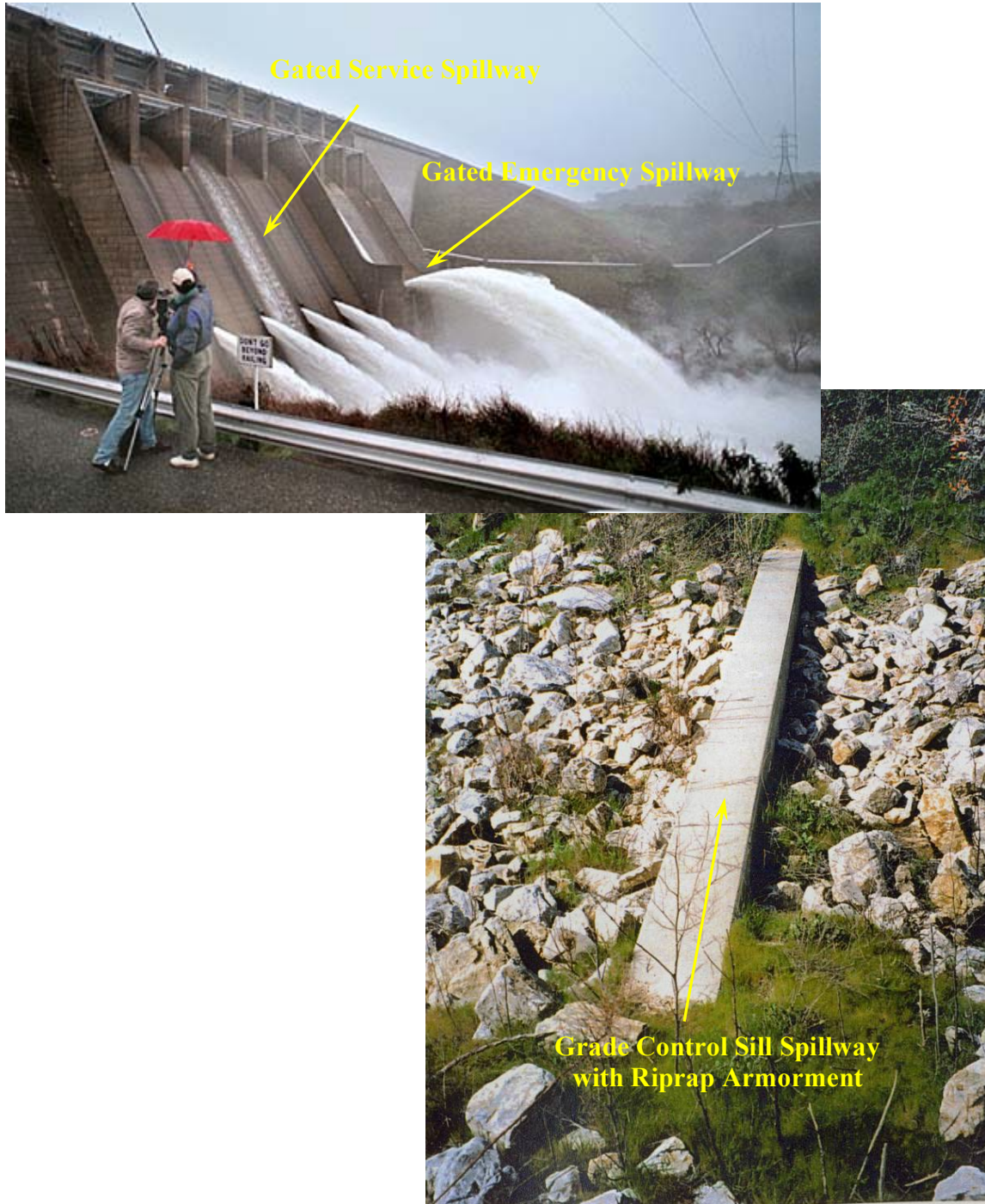
<sup>6</sup> A detention dam is constructed to temporarily store streamflow or surface runoff, then release the stored water in a controlled manner.

<sup>7</sup> A diversion dam is constructed to divert (redirect) water from one waterway (such as a stream or river) into another waterway (such as a canal or pipeline).

<sup>8</sup> A forebay dam impounds water from another dam or hydroelectric plant intake structure (typically a pump-storage facility). A forebay dam can also be designated as a storage, run-of-the-river, and/or pump-storage dam.

<sup>9</sup> An afterbay dam is located downstream from another dam and/or hydroelectric plant and is used to regulate tailwater adjacent to the upstream dam and/or hydroelectric plant.

**Design Standards No. 14: Appurtenant Structures for Dams  
(Spillways and Outlet Works)**



**Figure 3.2.1.3-1. Emergency spillways, from top to bottom: Folsom Dam, California, and San Justo Dam, California.**

### Chapter 3: General Spillway Design Considerations

7-1686 (5-06)  
Bureau of Reclamation

#### RESERVOIR CAPACITY ALLOCATIONS

TYPE OF DAM Embankment - Zoned Earthfill		REGION MP	STATE California
OPERATED BY Bureau of Reclamation		Lake Example	RESERVOIR
CREST LENGTH 3,350 FT.	CREST WIDTH 40 FT.	Example Dam	DAM
VOLUME OF DAM 6,695 CU YD.		Example Project	PROJECT
CONSTRUCTION PERIOD 2000-2003		---	DIVISION
STREAM Example River		---	UNIT
RES AREA 3,090 ACRES AT EL 750	Operational		STATUS OF DAM
ORIGINATED BY:		APPROVED BY:	
J.H.L. <i>(Initials)</i>	86-68130 <i>(Code)</i>	12/15/2004 <i>(Date)</i>	R.K.M. <i>(Initials)</i>
			86-68130 <i>(Code)</i>
			12/15/2004 <i>(Date)</i>

(1) Includes 34,000 a.f. allowance for 60 year sediment deposition between streambed and EL 750 of which 20,000 a.f. is above EL 660

(2) Established by water supply (invert of intake for Lake Example tunnel)

**REFERENCES AND COMMENTS:**

Specifications DC-99999, Supplemental notices, and as-built drawings.

Technical Record of Design and Construction, July 2004.

Area-Capacity Table, No. 999-D-9999, 3 sheets.

Inactive storage will be used to satisfy downstream water rights and, by pumping, project water supply requirements during extremely dry periods when active conservation storage is exhausted.

**Figure 3.2.2-1. RCA example.**

**Design Standards No. 14: Appurtenant Structures for Dams  
(Spillways and Outlet Works)**

- **Exclusive flood control.** – The reservoir capacity assigned for the sole purpose of regulating flood inflows to reduce flood damage downstream. In some instances, the top of the exclusive flood control capacity is above the maximum controllable RWS elevation (either top of active conservation capacity or top of joint use capacity, whichever is greater). A few examples of Reclamation dams with exclusive flood control include: Ririe, Hoover, Brantley, Pueblo, and Jordanelle Dams.
- **Flood control pool (flood pool).** – Reservoir capacity above active conservation capacity and joint use capacity that is reserved for flood runoff and then evacuated as soon as possible to keep the reservoir volume in readiness for the next flood. Controlled releases occur generally when the RWS is within the flood control pool.
- **Joint use capacity.** – The reservoir capacity assigned to flood control purposes during certain periods of the year (normally when flooding is more likely to be a concern) and to conservation purposes during other periods of the year.
- **Active conservation capacity (active storage).** – The reservoir capacity assigned to regulate reservoir inflow for irrigation, power generation, municipal and industrial use, fish and wildlife, navigation, recreation, water quality, and other purposes. It does not include exclusive flood control or joint use capacity. It extends from the bottom (or the lowest RWS associated with the bottom of exclusive flood control, or the bottom of flood control pool, or the bottom of joint use capacity) to the top of the inactive capacity (or to the top of dead capacity where there is no inactive capacity).
- **Inactive capacity (inactive storage).** – The reservoir capacity exclusive of and above the dead capacity from which the stored water is normally not available because of operating agreements or physical restrictions (such as minimum hydraulic head needed to meet certain release requirements associated with power generation, irrigation, M&I, recreation, and environmental enhancements). Under abnormal conditions, such as a shortage of water or a requirement for structural repairs, water may be evacuated from this space. The inactive capacity extends from the bottom of active conservation capacity to the top of dead storage.

- **Dead capacity (dead storage).** – The reservoir capacity from which stored water cannot be evacuated by gravity (using existing hydraulic structures).
- **Live capacity.** – Reservoir storage that includes exclusive flood control capacity plus joint use capacity plus active capacity plus inactive capacity.
- **Total capacity.** – Reservoir storage that includes the live capacity plus dead capacity.

**Elevation definitions** associated with the RCA and reservoir operations for a given storage and multipurpose dam follow:

- **Crest of dam.** – The elevation of the uppermost surface of a dam, usually a road or walkway, excluding any parapet wall, railing, curb, etc. On embankment dams, the crest of the dam is the top of the embankment, not including camber, crown, or roadway surfacing. The extra height (camber) added to the crest of embankment dams is to ensure that the freeboard will not be diminished by foundation settlement or embankment consolidation.
- **Maximum water surface.** – The maximum or highest RWS reached during the passing of a flood event up to the PMF. The maximum RWS reached during the passing of the IDF represents the maximum reservoir elevation used to size the dam and associated appurtenant structures such as spillways and outlet works
- **Top of exclusive flood control.** – The RWS elevation at the top of the reservoir capacity allocated to exclusive use for the regulation of flood inflows to reduce damage downstream.
- **Top of joint use.** – The RWS elevation at the top of the reservoir capacity allocated to joint use (i.e., flood control and conservation purposes).
- **Top of active conservation.** – The RWS elevation at the top of the capacity allocated to the storage of water for conservation purposes only. If there is no joint use capacity associated with the reservoir, top of active conservation is the RWS elevation above which no reservoir storage will occur under normal operating conditions.
- **Top of inactive.** – The RWS elevation below which the reservoir will not be evacuated under normal conditions.

**Design Standards No. 14: Appurtenant Structures for Dams  
(Spillways and Outlet Works)**

- **Top of dead.** – The lowest elevation in the reservoir from which water can be drawn or released by gravity.
- **Streambed at dam axis.** – The lowest point of elevation in the streambed at the axis or centerline of the dam prior to construction. This elevation defines the hydraulic height and normally defines zero storage or surface area for the area capacity tables.
- **Lowest point of foundation excavation.** – The lowest point of elevation below the streambed that is reached during excavation of the dam foundation (excluding treated narrow/small fault zones).
- **Hydraulic height.** – The vertical distance between the lowest point in the streambed at the axis or centerline of the dam, or the invert of the lowest outlet works, whichever is lower, and the maximum controllable RWS (either top of active conservation or top of joint use capacity, whichever is higher).
- **Structural height.** – General definition is the vertical distance between the lowest point in the excavated foundation (excluding narrow treated/small fault zones) and the crest of the dam.
  - For embankment dams, the structural height is the vertical distance between the dam crest and the lowest point in the excavated foundation area, including the main cutoff trench, if any, but excluding small trenches or narrow backfilled areas. The crest elevation does not include the camber, crown, or roadway surfacing.
  - For concrete dams, the structural height is the vertical distance between the top of the dam and the lowest point of the excavated foundation area, excluding narrow fault zones.

Three general types of storage and multipurpose dams include: concrete dams, embankment dams, and composite dams. These storage and multipurpose dam types are further discussed in the following sections.

**3.2.2.1 Concrete Dams**

Less than 10 percent of Reclamation’s inventory of storage and multipurpose dams are concrete dams. Some of the better known Reclamation concrete dams include: Hoover, Grand Coulee, Shasta, and Buffalo Bill Dams. General types of concrete dams include arch, buttress, multiple-arch, and gravity structures. Typical construction materials include mass concrete, reinforced concrete, roller compacted concrete (RCC), and masonry. With few exceptions, a competent rock foundation is required for a suitable concrete dam site. For additional information and details about concrete dams, refer to *Design Standards No. 2, Concrete Dams*.

### 3.2.2.2 Embankment Dams

The vast majority of Reclamation's inventory of storage or multipurpose dams is embankment dams. Some of the better known Reclamation embankment dams include: Blue Mesa, Jordanelle, and Horseshoe Dams. General types of embankment dams include earthfill and rockfill dams. Construction materials are typically soil and rock from local sources. Other materials may include concrete, soil cement, and RCC, which may be used as facing elements and/or impervious barriers. Due to a large footprint and lower stresses in the dam foundation, the foundation requirements for embankment dams are less stringent than those for concrete dams (with appropriate engineering an embankment dam can be placed on both soil and rock foundations). For additional information and details about embankment dams, refer to *Design Standards No. 13, Embankment Dams*.

### 3.2.2.3 Composite Dams

Reclamation's inventory of storage or multipurpose dams includes a few composite dams, which are a combination of concrete and embankment dams. Some of the better known Reclamation composite dams include: Folsom, Pueblo, and Minidoka Dams. Construction materials include those associated with both concrete and embankment dams. Competent rock foundations would still be expected for the concrete portion of a composite dam, while less stringent foundation requirements (soil and/or rock) may be acceptable for the embankment portion of a composite dam.

## 3.3 Function

Spillways are provided for storage, multipurpose, and detention dams to release surplus water or flood water that cannot be contained in the allotted storage space, and for diversion dams to bypass flows exceeding those turned (redirected) into the diversion system. Ordinarily, the excess storage is drawn from the top of the reservoir and conveyed through waterways or hydraulic structures (such as spillways, outlet works, canals, pipelines, etc.) back to the river or to some natural drainage channel [3].

### 3.3.1 General

The importance of a safe, reliable spillway cannot be overemphasized; many failures of dams have been caused by improperly designed and/or constructed spillways or by spillways of insufficient discharge capacity. Ample discharge capacity is of paramount importance for composite and embankment dams, which are likely to fail if overtopped (depending on the erosion resistance of

## **Design Standards No. 14: Appurtenant Structures for Dams (Spillways and Outlet Works)**

the foundation), whereas concrete dams may be able to withstand moderate overtopping. Usually, the increase in cost of constructing a new spillway is not directly proportional to the increase in discharge capacity. The cost of a spillway having ample discharge capacity is often only moderately higher than the cost of a spillway that is too small [3]. It should be kept in mind that future modifications to increase the discharge capacity of an existing spillway may be much larger than the initial cost of providing the same discharge capacity for a new spillway.

In addition to providing sufficient discharge capacity, the spillway must be located so that releases do not erode or undermine the downstream toe of the dam. The spillway's flow surfaces must be erosion resistant to withstand the high scouring velocities created by the elevation drop from the RWS to the tailwater (downstream) level. Usually, a feature typically referred to as a "terminal structure" is required to dissipate the kinetic energy of the moving water at or below the tailwater level [3] without damaging the dam or downstream property.

The frequency of spillway operation should be determined by the hydrologic characteristics of the drainage basin and available storage. Ordinary (normal) riverflows are stored in the reservoir, diverted through other hydraulic structures such as a canal headworks, or released through an outlet works. During ordinary flows, the spillway is typically not required to function. However, spillway flows do occur during floods or periods of sustained high runoff, when the discharge capacities of the other hydraulic structures are exceeded and available storage capacity has been filled. Where large reservoir storage is provided, or larger outlet works or diversion capacity is available, the spillway will be used infrequently. On the other hand, at some storage and multipurpose dams, and most diversion dams, where storage space is limited and/or diversion capacities are relatively small compared with normal riverflows, the spillway will often be used annually and, in some cases, almost constantly [3].

### **3.3.2 Checklist and Procedure – Spillway Design**

This section is the primary focus of chapter 3 and summarizes how Reclamation analyzes and designs both new spillways and modifications of existing spillways. The "Checklist – Spillway Design Considerations" (Checklist) itemizes technical activities. Table 3.3.2-1, "Procedures for spillway design using quantitative risk analysis," provides the design steps.



**CHECKLIST – Spillway Design Considerations**

Data Table		Location Table		Type and Size Table		Analysis and Design Table
<ol style="list-style-type: none"> <li>1. Reservoir and site topography (develop topography for identified potential spillway locations): Refer to <i>Design Data Collection Guidelines</i> [6]*.</li> <li>2. Reservoir and site geology (develop geologic data including subsurface and material data for identified potential spillway locations): Refer to <i>Design Data Collection Guidelines</i> [6]*</li> <li>3. Seismicity (earthquakes), which include earthquake return periods that could range from a Design Basis Earthquake (DBE) for noncritical structures to risk based earthquake loadings for critical structures that could be in the range of 10,000- to 50,000-year return periods: Refer to section 3.8 in this chapter.</li> <li>4. Hydrology (floods), which include flood and nonflood season frequency events to determine the IDF and identify/select construction diversion floods: Refer to section 3.4 in this chapter.</li> <li>5. Reservoir operations would be defined in the Standing Operating Procedures (SOP) for existing Reclamation dams. Also, release requirement agreements with other agencies or owners may need to be considered. For other non-Reclamation existing dams or for new dams, reservoir operations should be well defined by the Owner/Client: Refer to <i>Design Data Collection Guidelines</i> [6]*</li> <li>6. Reservoir storage would be defined in the SOP for existing Reclamation dams. For other non-Reclamation existing dams or for new dams, reservoir storage should be well defined by the Owner/Client. If not available, reservoir storage will be developed from reservoir topography. Also, RCAs should be defined and include some or all of the following: dead storage capacity, inactive capacity, active conservation capacity, joint use capacity, and exclusive flood control: Refer to section 3.2.2 in this chapter and <i>Design Data Collection Guidelines</i> [6]*</li> </ol> <p>* NOTE: Dam design data collection requirements are used since there are no design data collection requirements specifically identified for spillways.</p>	<p><b>Parallel with and/or Interactive Between Data, Location and Type/Size</b></p>	<ol style="list-style-type: none"> <li>1. Where possible, avoid locating spillway on (surface) or through (subsurface) embankment dams (embankment material may settle, causing unfavorable foundation conditions). The exception is overtopping protection to serve as an auxiliary or emergency spillway for an existing embankment dam or for a new or existing concrete dam: Refer to section 3.5 in this chapter.</li> <li>2. Locate spillway on (surface) dam abutment or reservoir rim for embankment dams: Refer section 3.5 in this chapter .</li> <li>3. Spillway integral (surface or subsurface) with concrete dam may provide best location. If not, consider dam abutment or reservoir rim: Refer to section 3.5 in this chapter.</li> <li>4. For dam sites with steep abutments and/or unsuitable surface areas along the reservoir rim, a subsurface (tunnel) spillway may be an option.</li> <li>5. Preferred foundation is rock, if available. Some soils may provide suitable foundation (gravel to gravelly soils, sands to sandy soils, and some fine-grained soils with low to medium compressibility, but permeability as related to internal erosion potential must be carefully evaluated): Refer section 3.5 and section 3.7 in this chapter.</li> <li>6. For soil foundation, which is removed and replaced with engineered fill, or for soil foundation disturbed before placement of concrete, minimum compactive levels would include 94% compaction (cohesionless soil) using vibratory hammer testing, or 95% Proctor density (cohesive soils). It may be necessary to either design the spillway to accommodate settlement or treat the foundation to minimize the settlement: Refer to section 3.7 in this chapter.</li> </ol>	<p><b>Parallel with and/or Interactive Between Data, Location and Type/Size</b></p>	<ol style="list-style-type: none"> <li>1. Identify spillway classification: service, auxiliary, and/or emergency spillway: Refer to section 3.2, section 3.3, and section 3.4 in this chapter.</li> <li>2. Identify potential control structure types. Considerations will include: dam type; spillway classification; discharge capacity; foundation conditions; loading conditions; and reservoir operational requirements: Refer to section 3.5 in this chapter.</li> <li>3. Initial sizing (including elevations and dimensions) of control structures via discharge capacity estimates: Refer to section 3.6 in this chapter.</li> <li>4. Evaluate and select hydrologic and seismic design loadings in risk framework: Refer to Chapter 2, “Hydrologic Considerations,” in this design standard and section 3.8 in this chapter.</li> <li>5. Refine viable control structures via refining discharge capacity and flood routings. Also, refine design for foundation, structural, mechanical, and electrical considerations: Refer to section 3.6, section 3.7, section 3.8, and section 3.9 in this chapter.</li> <li>6. Identify initial conveyance features and terminal structure for viable control structures. Base this on initial hydraulic, foundation, structural, mechanical, and electrical analyses: Refer to section 3.6, section 3.7, section 3.8, and section 3.9 in this chapter.</li> <li>7. Estimate initial baseline risks for viable alternative spillways (adjust as needed): Refer to appendix B in this chapter and <i>Best Practices</i> [7].</li> <li>8. Lay out and prepare cost estimates of viable alternative spillways (combinations of control structure, conveyance features, and terminal structure) which have acceptable initial baseline risks: Refer to appendix B in this chapter; <i>Best Practices</i> [7]; and <i>Estimate Worksheet – Guide for Designers</i> [8].</li> <li>9. Develop viable construction diversion scheme, based on construction schedule, resulting in acceptable construction risks: Refer to DS 14, chapter 2, in this design standard and <i>Best Practices</i> [7].</li> <li>10. Select recommended viable alternative spillway(s).</li> </ol>	<p><b>Parallel with and/or Interactive Between Data, Location and Type/Size</b></p>	<ol style="list-style-type: none"> <li>1. Finalize hydraulic analyses and designs for recommended viable alternative spillway(s): Refer to section 3.6 and appendix A in this chapter. <ul style="list-style-type: none"> <li>• Discharge Capacity (section 3.6.1).</li> <li>• Flood Routing (section 3.6.2).</li> <li>• Reservoir Evacuation and First Filling (section 3.6.3).</li> <li>• Other Hydraulics (section 3.6.4).</li> </ul> </li> <li>2. Finalize foundation analyses and designs for recommended viable alternative spillway(s): Refer to section 3.7 in this chapter. <ul style="list-style-type: none"> <li>• Elastic Foundation (section 3.7.1).</li> <li>• Foundation Design (section 3.7.2).</li> <li>• Drainage and Insulation (section 3.7.3).</li> </ul> </li> <li>3. Finalize structural analyses and designs for recommended viable alternative spillway(s): Refer to section 3.8 in this chapter. <ul style="list-style-type: none"> <li>• Loading Conditions (section 3.8.1).</li> <li>• Seismic (Earthquake) Loading (section 3.8.2).</li> <li>• Stability Design (section 3.8.3)</li> <li>• Reinforced Concrete Design (section 3.8.4).</li> <li>• Reinforcement (section 3.8.5).</li> <li>• Joints, Waterstops, and Tolerances (section 3.8.6)</li> </ul> </li> <li>4. Finalize mechanical and electrical designs for recommended viable alternative spillway(s): Refer to section 3.9 in this chapter. <ul style="list-style-type: none"> <li>• Mechanical Features (section 3.9.1).</li> <li>• Operational Features (section 3.9.2).</li> </ul> </li> <li>5. Determine need for instrumentation and monitoring: Refer to section 3.10 in this chapter.</li> <li>6. Verify that baseline risks indicate decreasing justification to take action to reduce risks for recommended viable alternative spillway(s): Refer to appendix B in this chapter and <i>Best Practices</i> [5].</li> <li>7. Prepare technical documentation, such as design summary, supporting technical memoranda and reports, decision memoranda, designers operating criteria, and final construction report: Refer to <i>Safety of Dams Project Management Guidelines</i> [6], and examples can be provided.</li> </ol>



### 3.3.2.1 Checklist

The Checklist outlines Reclamation's approach to identifying and evaluating spillway type, and locating and sizing the spillway, along with refining analyses and designs of a spillway. The remainder of this chapter augments the Checklist.

Note: The Checklist provides listings of major technical activities but does not provide the overarching project management process used by Reclamation. For additional guidance about Reclamation's project management processes, please refer to *Final Design Process* [4] and *Safety of Dams Project Management Guidelines* [5].

Additional clarification of the Checklist includes:

- **Data.** – A Data Table summarizes considerations that are necessary to prepare analyses and designs for modifying existing spillways and constructing new spillways. This list covers all levels of analyses and design, ranging from appraisals and feasibilities to final designs. It is important to note that activities associated with the Data Table parallel and/or are interactive with activities associated with Location Table and the Type and Size Table.
- **Location.** – A Location Table summarizes considerations that are necessary to properly locate a new spillway (for an existing spillway, the location of the modification is already defined). As with the Data Table, this table covers all levels of analyses and design, ranging from appraisals and feasibilities to final designs. It is important to note that activities associated with the Location Table parallel and/or are interactive with activities associated with the Data Table and the Type and Size Table.
- **Type and Size.** – A Type and Size Table summarizes considerations that are necessary to properly select the type and size of a modification to an existing spillway or a new spillway design. As with the Data Table and Location Table, this table covers all levels of analyses and design, ranging from appraisals and feasibilities to final designs. It is important to note that activities associated with the Type and Size Table parallel and/or are interactive with activities associated with the Data Table and the Location Table.
- **Analysis and Design.** – An Analysis and Design Table summarizes considerations needed to refine and/or finalize the modification to an existing spillway or the design of a new spillway. As with the previous tables, this table covers all levels of analyses and design, ranging from appraisals and feasibilities to final designs.

**Design Standards No. 14: Appurtenant Structures for Dams  
(Spillways and Outlet Works)**

**3.3.2.2 Procedure**

Quantitative risk analysis methodology will be part of evaluating, analyzing, and/or designing modifications to existing spillways or designing new spillways. The procedure for applying quantitative risk analysis methodology is summarized in table 3.3.2-1.

**Table 3.3.2-1. Procedure for spillway design using quantitative risk analysis methodology**

<p>Step 1 <b>(Locate, Lay out, and Size)</b></p>	<p>Based on topography, geology, and hydrology, along with loading conditions and load combinations, locate, lay out, and size the modified or new spillway. For examples of locating, typing, and sizing a spillway, see Appendix A, “Examples: Spillway Location, Type, and Size,” in this chapter. For flood and seismic loadings, initial assumptions are made in terms of the return periods to be used for the IDF and design earthquake. Refer to Table 3.5.2.5-1, “Procedures for selecting spillway type and size,” in this chapter. For more details about selecting the IDF and design earthquake, see Chapter 2, “Hydrologic Considerations,” in this design standard; and Section 3.8.2, “Seismic (Earthquake) Loads,” in this chapter.</p>
<p>Step 2 <b>(Perform Risk Analysis)</b></p>	<p>When modifying an existing spillway, prepare or update baseline risk analysis and prepare modified risk analysis. When designing a new spillway, prepare baseline risk analysis. Note: Risk analyses should be comprehensive where total risks are estimated (i.e., evaluates all credible potential failure modes [PFMs] associated with static, hydrologic, and seismic loadings). For a list of typical PFMs associated with spillways, see appendix B, “Potential Failure Modes (PFMs) for Spillways,” in this chapter. Also, for more details about identifying/evaluating PFMs and preparing or updating risk analyses, see Reclamation’s <i>Dam Safety Risk Analysis Best Practices Training Manual</i> [7].</p>
<p>Step 3 <b>(Evaluate Risk Analysis Results)</b></p>	<p>Evaluate risk analysis results in terms of:</p> <ul style="list-style-type: none"> <li>• Are total modified risks (for existing spillway) or baseline risks (for new spillway) acceptable? (If YES, go to last bullet – if NO, go to next bullet.)</li> <li>• What PFMs significantly contribute to the total risks? (As an example, risks associated with an earthquake-induced failure of the spillway control structure might be very large, so a more remote earthquake than initially assumed as the design load could reduce this PFM risk and also total risks).</li> <li>• Are construction risks (associated with modifying an existing spillway or constructing a new spillway) acceptable? (If YES, go to step 5 – if NO, go to step 4).</li> </ul>
<p>Step 4 <b>(Revise Loading Conditions)</b></p>	<p>Identify revised loading conditions (such as more remote flood and/or earthquake design load return periods) and changes to the spillway design that would result in reduced risks for PFMs that significantly contribute to the total risks, along with limiting construction risks. Repeat steps 1 through 3.</p>

**Table 3.3.2-1. Procedure for spillway design using quantitative risk analysis methodology**

<p>Step 5 <b>(Identify Minimum Loading Conditions)</b></p>	<p>Identify minimum static, hydrologic, and seismic loadings that would reduce total risks to acceptable levels (results from Step 3 or Step 4). It should be highlighted that for a new spillway or new features of an existing spillway, all appropriate structural criteria, guidelines, code, and safety factors must be met as a minimum. Designs using quantitative risk analysis may dictate these minimum structural and stability requirements be exceeded but never decreased. Note: Presently, hydrologic load uncertainties are addressed in a Robustness (freeboard) study (see Chapter 2, “Hydrologic Considerations” in this design standard). Processes to evaluate static and seismic load uncertainties are not well defined, but would generally follow a similar approach as noted for the hydrologic load uncertainties.</p>
<p>Step 6 <b>(Evaluate Non-risk Factors)</b></p>	<p>Evaluate nonrisk factors (i.e., cost, physical constraints, etc.) that need to be considered in addition to the risk factors.</p>
<p>Step 7 <b>(Refine)</b></p>	<p>Based on the previous steps, refine modifications to existing spillway or design of new spillway.</p>

### 3.3.3 Relationship Between Reservoir Storage and Spillway Discharge Capacity

A very important relationship exists between the storage capacity of a reservoir and the discharge capacity of hydraulic structures, particularly a spillway. As previously discussed in Section 3.2.2, “Dams,” in this chapter, Reclamation uses official (authorized) reservoir capacity allocations (RCA) to achieve specific purposes associated with a given storage or multipurpose dam. The RCA will establish key storage and elevation requirements which, in turn, will influence discharge capacity needs (for definitions of RCA terms and an example of a RCA sheet see Section 3.2.2, “Dams,” and figure 3.2.2-1 in this chapter, respectively). The relationship between reservoir storage, as defined by the RCA, and spillway discharge capacity is further highlighted by the following bullets.

- **Limited reservoir storage capacity.** – Where there is limited or no storage capacity (usually above the maximum normal reservoir water surface elevation, which is defined by the top of active conservation or top of joint use, whichever is higher), the hydraulic structures must be able to pass the peak flood inflow without (or with limited) increases to the RWS. Under this condition, the flood peak rate of inflow is of primary interest, and the total volume of the flood is of lesser importance.

## Design Standards No. 14: Appurtenant Structures for Dams (Spillways and Outlet Works)

- **Large reservoir storage capacity.** – Where a relatively large reservoir storage capacity exists, a portion of the flood volume can be retained temporarily in the reservoir, and the hydraulic structure discharge capacity may be smaller than the flood peak rate of inflow.
- **Store entire flood.** – An unusual case would be providing sufficient storage to initially retain the entire flood volume, then slowly releasing the flood surcharge at a later date. Under these circumstances, a spillway may not be needed as long as other hydraulic structures, such as an outlet works, could evacuate the flood surcharge storage in a timely fashion. There are some storage and multipurpose dams in Reclamation’s inventory that do not have a spillway because they can safely store the entire flood event.<sup>11</sup> Most of these dams are associated with off-stream reservoirs which have small tributary drainage areas and are maintained with augmented inflow through the use of canals, pump-storage, tunnels, etc.

In most cases, the preferred option will be a combination of providing reservoir flood storage and spillway discharge capacity to safely accommodate flood events. The driving factors supporting the preferred option will include economics, operational requirements, site conditions, and dam safety considerations [3]. The reader is directed to appendix A, which presents examples of locating, typing, and sizing modifications to existing spillways and constructing new spillways.

### 3.3.4 Spillway Configuration

There are some common or typical configurations (features) associated with spillways. Generally speaking, features common to most spillways are illustrated in figure 3.3.4-1 and include:

- **Approach or inlet (upstream) channel and safety/debris/log boom.** This channel conveys water from the reservoir to the inlet structure or to the control structure if there is no inlet structure.
- **Inlet structure,** which conveys water from the approach channel to the control structure and is intended to improve approach conditions to the control structure.

---

<sup>11</sup> Storage and multipurpose dams without spillways are the exception, not the rule. Some of Reclamation’s storage and multipurpose dams without spillways include Deer Flat Dam in Idaho, Dry Falls Dam in Washington, Ridges Basin Dam and Marys Lake Dike in Colorado, and Soldiers Creek Dam in Utah.

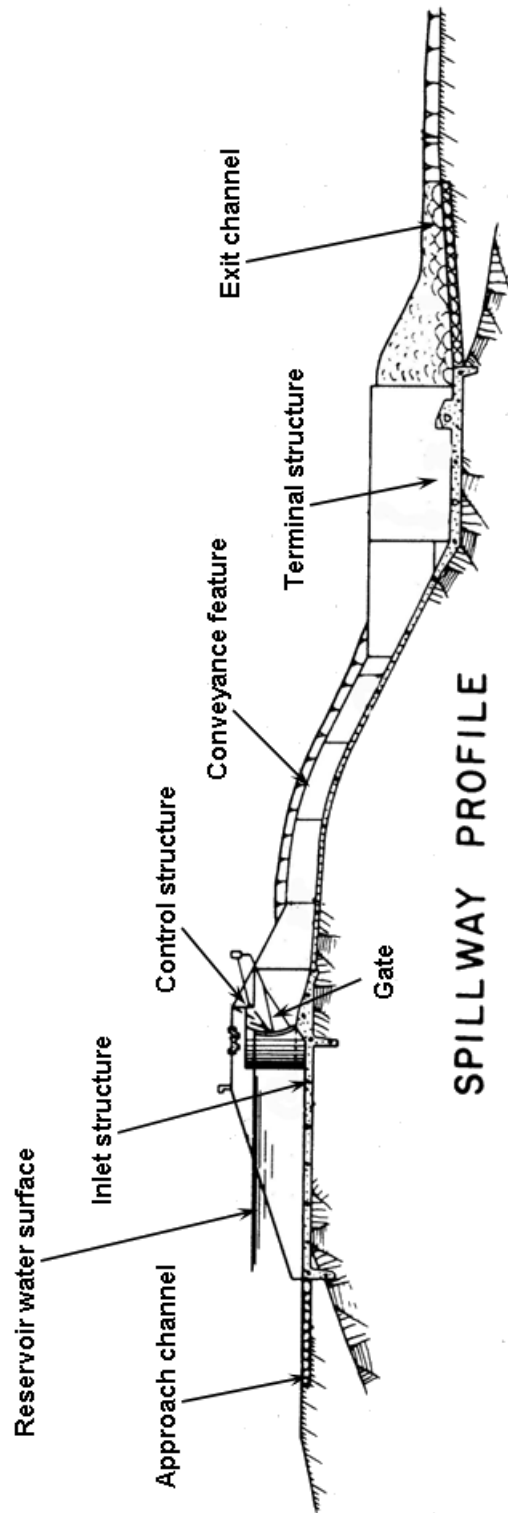


Figure 3.3.4-1. Spillway configuration – Common features.

## Design Standards No. 14: Appurtenant Structures for Dams (Spillways and Outlet Works)

- **Control structure** could be a crest structure or grade control sill, and include gates, bulkheads, or stoplogs, along with associated operating equipment. This structure provides the hydraulic control (establishes the discharge capacity) for the spillway. Also, many control structures will include traffic and/or operations (hoist) bridges.<sup>12</sup> With wide spillways, intermediate bridge supports (piers) along the flow surface are required. Also, piers may be needed to accommodate gates, stoplogs, or bulkheads. Another thing to consider when configuring the spillway is the type of hydraulic control. The two types are: (1) uncontrolled or free-flow spillways, and (2) controlled, or gated, or staged spillways. The hydraulic control is usually based on whether the spillway control structure has gates, temporary features (such as embankment fuseplugs), or not.
- **Conveyance feature** could be a chute, conduit, or tunnel. This feature conveys water from the control structure to the terminal structure. The conveyance feature may include combinations of elements such as chutes with both mild and steep flow surface slopes, combinations of conduits, tunnels, and chutes, etc. The conveyance feature configuration will be influenced by many factors, including geology, topography, and operational requirements.
- **Terminal structure** could be a hydraulic jump stilling basin, flip bucket, or plunge pool. This structure either dissipates most of the kinetic energy associated with moving water and conveys the water from the conveyance feature to the exit channel or conveys high energy flow downstream where the kinetic energy is dissipated within the natural river or stream channel.
- **Exit, outlet, or discharge (downstream) channel** conveys water from the terminal structure to the river or stream.

### 3.4 Design Floods

For storage and multipurpose dams, there are two primary hydrologic loadings that should be evaluated, and they are summarized in the following sections. It is important to note that the entire range of hydrologic loads may need to be evaluated to address the two hydrologic loadings noted below.

---

<sup>12</sup> For more information about bridges, refer to Chapter 9, “Bridges and Roads,” in Design Standards No. 3, *Water Conveyance Facilities, Fish Facilities, and Roads and Bridges*.



### 3.4.1 Inflow Design Flood

The IDF is the maximum flood hydrograph, or ranges of hydrographs, used in the design of a dam and its appurtenant structures, particularly for sizing the dam, spillway, and outlet works. Most storage and multipurpose dams are designed to safely accommodate floods up to and including the IDF, which will be equal to or smaller than the current critical PMF.<sup>13</sup> As described in detail in Chapter 2, “Hydrologic Considerations,” in this design standard, selection of the IDF for an existing and/or new dam is based on quantitative risk analysis methodology. The modified or new spillways cannot be (hydraulically) sized until the IDF has been identified.

### 3.4.2 Construction Diversion Floods

Any time construction activities occur in and/or around streams or rivers, consideration must be given to safely passing both normal streamflow and flood events during the construction period (i.e., diverting flows through and/or around the construction area with no or limited impacts to construction efforts and the downstream area). Diversion methods are sized by balancing the estimated cost of the diversion method and the risk associated with a larger flood occurring than the flood used to size the diversion method. The process for identifying/selecting the construction diversion flood used to size the diversion method is described in detail in Chapter 2, “Hydrologic Considerations,” in this design standard.

## 3.5 Spillway Location, Type, and Size

It is very important to understand that a spillway is a key feature of a dam, and its location, type, and size are critical to ensure reliable and safe reservoir operations that meet project operational needs.

### 3.5.1 Spillway Location

The optimum location of the spillway will be site specific, but there are some overarching considerations to keep in mind when locating spillways. These considerations are discussed in the following sections.

---

<sup>13</sup> It should be noted that more than one type of PMF can occur at a given dam site (rain-on-snow, thunderstorm, etc.), which leads to an important concept: the critical PMF. This flood event is defined as the PMF that would typically result in the highest maximum RWS.

**Design Standards No. 14: Appurtenant Structures for Dams  
(Spillways and Outlet Works)**

**3.5.1.1 Dam Abutments**

Preferred locations for a spillway include the dam abutments adjacent to or near the ends of the dam (especially embankment dams). This would include both surface and subsurface (tunnel) spillways for embankment, concrete, and composite dams. Locating the spillway would be dependent on topography, geology, and economics.

**3.5.1.2 Reservoir Rim**

Another potential location for a spillway is the reservoir rim (located away from the dam). This would include both surface and subsurface (tunnel) spillways for embankment, concrete, and composite dams. Locating the spillway would be dependent on topography, geology, and economics. It should be noted that, although a spillway can be located on or through the reservoir rim, care should be taken to evaluate the exit channel and downstream area. In some situations, locating a spillway on or through the reservoir rim would allow releases to enter a different drainage area than that associated with the main river or stream. During spillway operation, this could adversely impact downstream areas that were not subject to flooding prior to the dam or spillway being constructed. The downstream consequences (both property damage and potential life loss) will need to be fully evaluated before locating a spillway that could release flows into a different drainage area or a tributary that enters the main waterway downstream from the dam.

**3.5.1.3 Over or Through a Dam**

A spillway should not be located over or through an existing or new embankment dam and/or dike, or the embankment portion of a composite dam, unless there are very unusual circumstances. An unusual circumstance might involve an existing embankment dam where the reservoir surcharge and discharge capacities of existing hydraulic structures are inadequate to safely pass flood events and the dam abutments and/or the reservoir rim do not offer feasible locations for a spillway. In this case, an auxiliary or emergency spillway in the form of overtopping protection of the embankment dam could be considered. For further information about overtopping protection, refer to *Technical Manual: Overtopping Protection for Dams* [9].

A spillway can be located on or through (integral with) an existing or new concrete dam. Also, the concrete portion of a composite dam may be able to accommodate the spillway. Locating the spillway on or through the concrete dam or the concrete portion of a composite dam would be acceptable as long as it does not produce unacceptable stress concentrations associated with the dam. There may be both economic and technical reasons to have the spillway integral with the dam, which could provide spillway releases with the most direct path between the upstream reservoir and the downstream river or stream. It should be pointed out that although spillways have been placed in or on new conventional mass concrete dams with minimal disruption to construction operations, care must be taken placing spillways in or on a new roller compacted concrete (RCC) dam to avoid

significant impacts to construction operations. To minimize impacts considerations is given to either isolating the spillway from RCC operations and/or constructing a stepped chute spillway which utilizes the downstream dam (stepped) face.

#### **3.5.1.4 Spillway Foundations**

A spillway can be located on rock or soil foundations, but if available, it is highly recommended that a spillway be located on a rock foundation. More robust design and construction considerations will be needed for a soil foundation. These considerations are further discussed in Section 3.7, “General Foundation Considerations,” in this chapter.

### **3.5.2 Spillway Type and Size**

Reclamation has historically identified a spillway by its conveyance feature or by its predominant feature or component [12]. Examples include:

- Gated chute service spillway with straight ogee crest and hydraulic-jump stilling basin
- Ungated tunnel inlet service spillway with deflector bucket energy dissipater

This approach fully defines the spillway type by identifying the major components of a given spillway. However, the predominant component of many spillways tends to be the control structure. Therefore, with some exceptions, the spillway will be referred to by the type of control (crest) structure. For more information, refer to the spillway type chart (see figure 3.5.2-1).

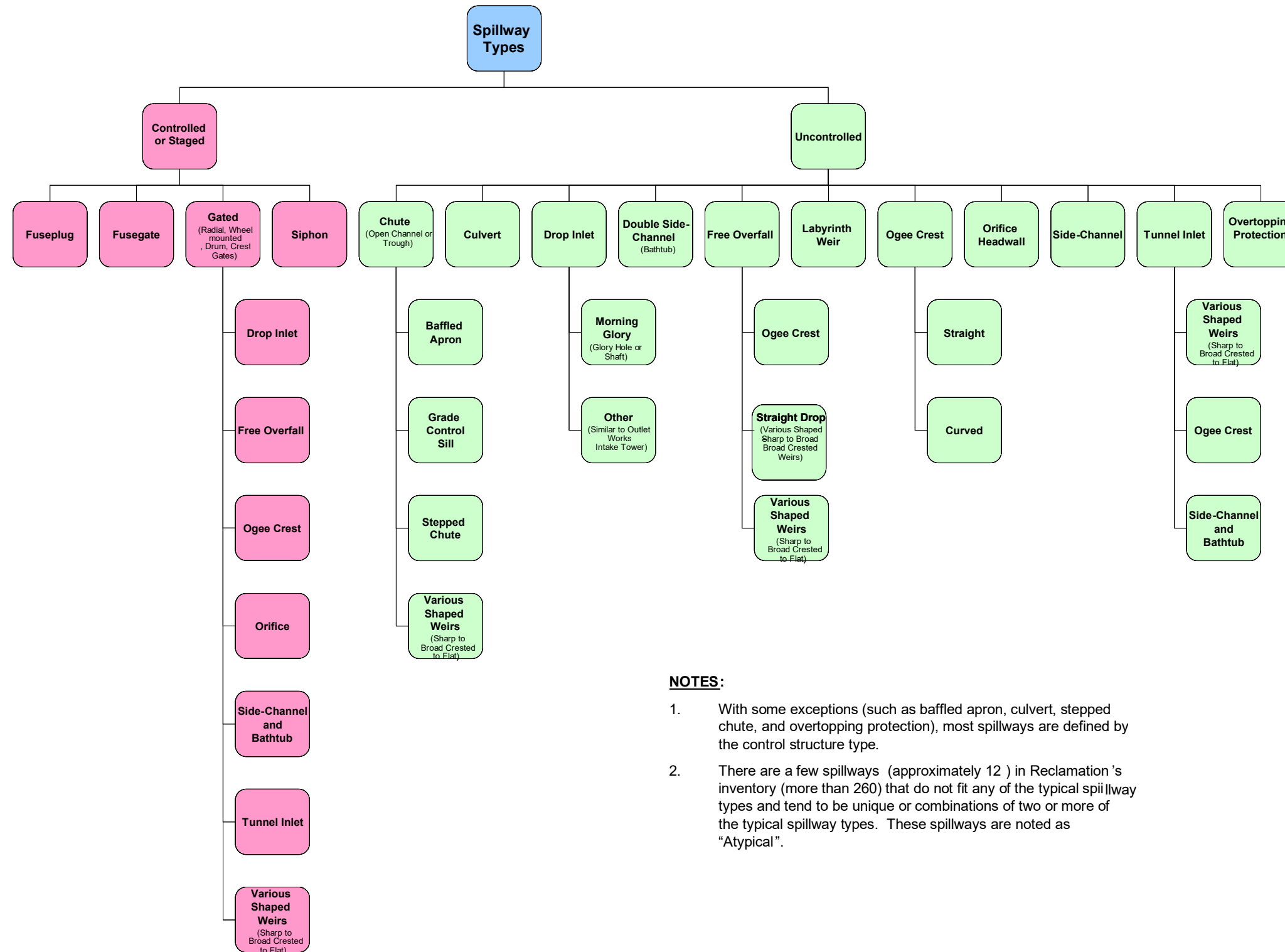
#### **3.5.2.1 Uncontrolled Spillways**

Common to all uncontrolled spillways that are not integral with a concrete dam (i.e., located away from the dam on or through abutments, or on or through reservoir rim) is that existing topography must provide adequate space without excessive excavation. Also, the existing topography must allow appropriate orientation (alignment of the spillway between the reservoir and downstream river or stream) of the conveyance feature and terminal structure. Additionally, economics will come into play for all uncontrolled spillways. Some of the more common uncontrolled spillway types are discussed in the following text.

- Chute (open channel or trough) spillways include baffled apron, grade control sill, stepped chute, and various shaped weirs (see the spillway chart, figure 3.5.2-1):

**Design Standards No. 14: Appurtenant Structures for Dams  
(Spillways and Outlet Works)**

- **Baffled apron spillway** (see figure 3.5.2.1-1). – This type of structure is suited for service, auxiliary, and emergency spillways. Baffled apron spillways provide crest control, conveyance, and energy dissipation in one structure [12]. Primary considerations are associated with low to moderate hydraulic heads to ensure the baffles function properly and crest lengths are limited (i.e., significant cost increases as crest length increases). Additionally, this spillway may be practical in areas where there is limited space for a terminal structure such as a hydraulic jump stilling basin. Also, effectiveness (energy dissipation and discharge capacity) of baffled apron spillways can be adversely impacted by debris. An example of a baffled apron spillway is the service spillway at Reclamation’s Conconully Dam (embankment).
  
- **Grade control sill spillway** (see figure 3.5.2.1-2). – This type of control structure is primarily suited for auxiliary and emergency spillways; however, in some cases, it can function as a service spillway. A grade control sill is a less robust, minimal spillway typically limited to a vertical reinforced concrete wall (sill) that is placed in a trench through an excavated trapezoidal channel. The grade control sill can be constructed in both rock and soil foundations. The grade control sill spillway tends to have limited reserve discharge capacity, given channel armorment could be damaged or fail due to discharges that exceed design levels. Therefore, an important consideration is to limit potential erosion during spillway operation. In summary, this type of spillway should only be used on low head situations where the hydraulic drop (vertical dimension between the RWS and the downstream river or stream) can be effectively controlled, including limiting erosion potential. Examples of grade control sill spillways include the service spillway at Reclamation’s Crane Prairie Dam (embankment) and the emergency spillway at Reclamation’s Davis Creek Dam (embankment).
  
- **Stepped chute spillway** (see figure 3.5.2.1-3). – This type of structure is suited for service and auxiliary spillways. Stepped spillways refer to the stepped chute portion of the spillway and have primarily been used with RCC dams, which take advantage of the RCC lift construction methods, resulting in offsets on the downstream dam face, creating the spillway steps. These steps can be formed or unformed RCC or capped with conventional concrete. A chute-type crest (flat), along with straight or curved ogee crests, are typically used in combination with stepped chutes. Other applications have involved incorporating both smooth flow surfaces and steps into a reinforced concrete spillway chute and RCC overtopping protection for an earth dam. A consideration for a stepped spillway involves the potential kinetic energy dissipation via the steps, which can reduce the size and type of the terminal structure [12]. However, the kinetic energy dissipation



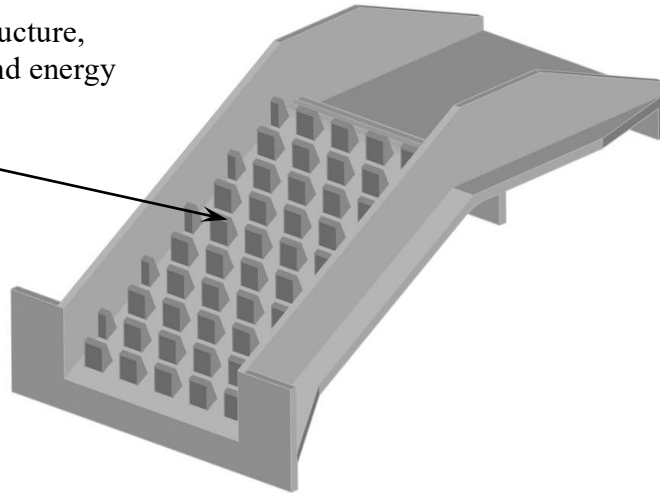
**NOTES:**

1. With some exceptions (such as baffled apron, culvert, stepped chute, and overtopping protection), most spillways are defined by the control structure type.
2. There are a few spillways (approximately 12 ) in Reclamation's inventory (more than 260) that do not fit any of the typical spillway types and tend to be unique or combinations of two or more of the typical spillway types. These spillways are noted as "Atypical".

Figure 3.5.2-1. Spillway type chart.



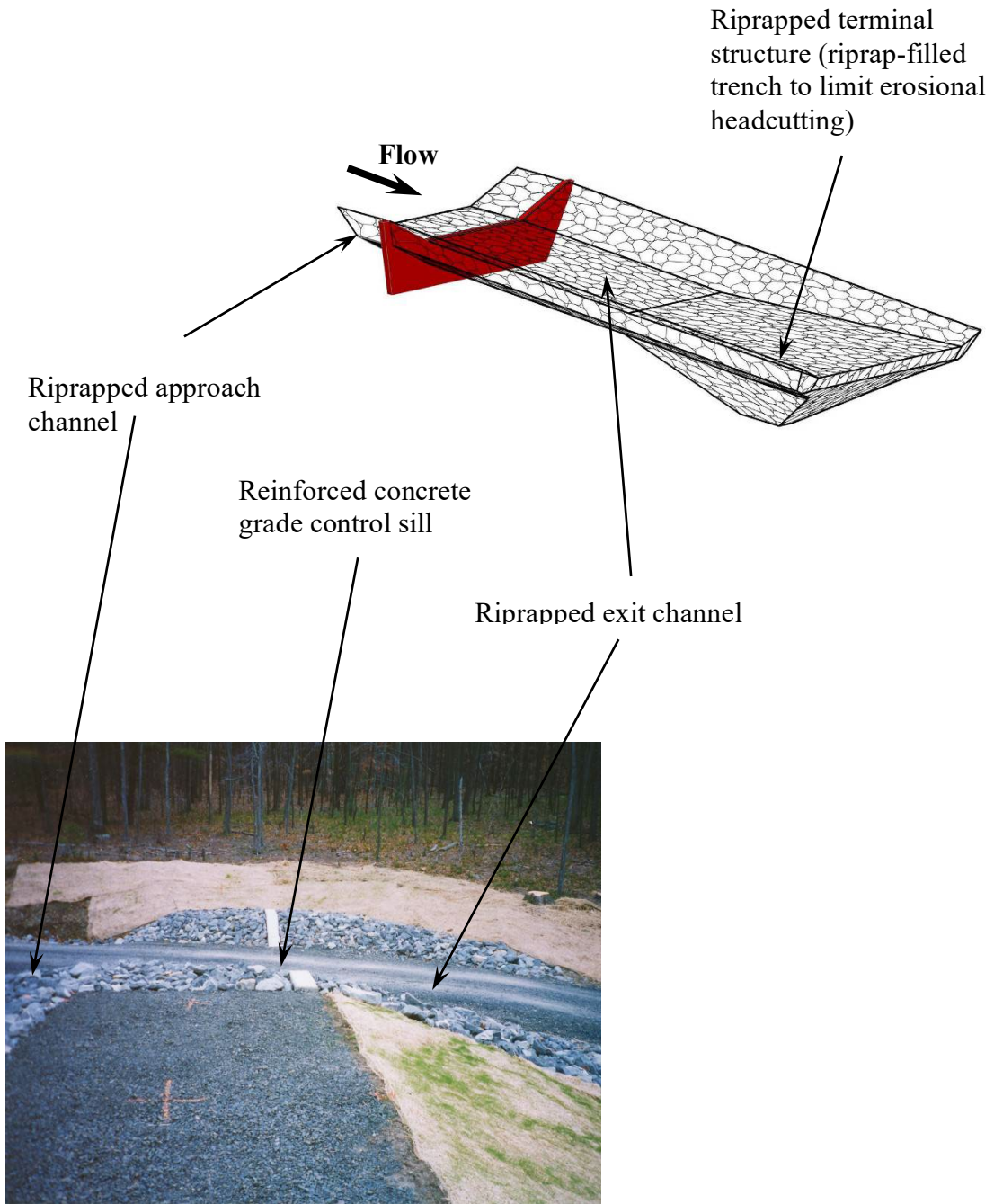
Reinforced concrete  
(combined) control structure,  
conveyance feature, and energy  
dissipation structure



Baffled apron service spillway, Conconully Dam, Washington

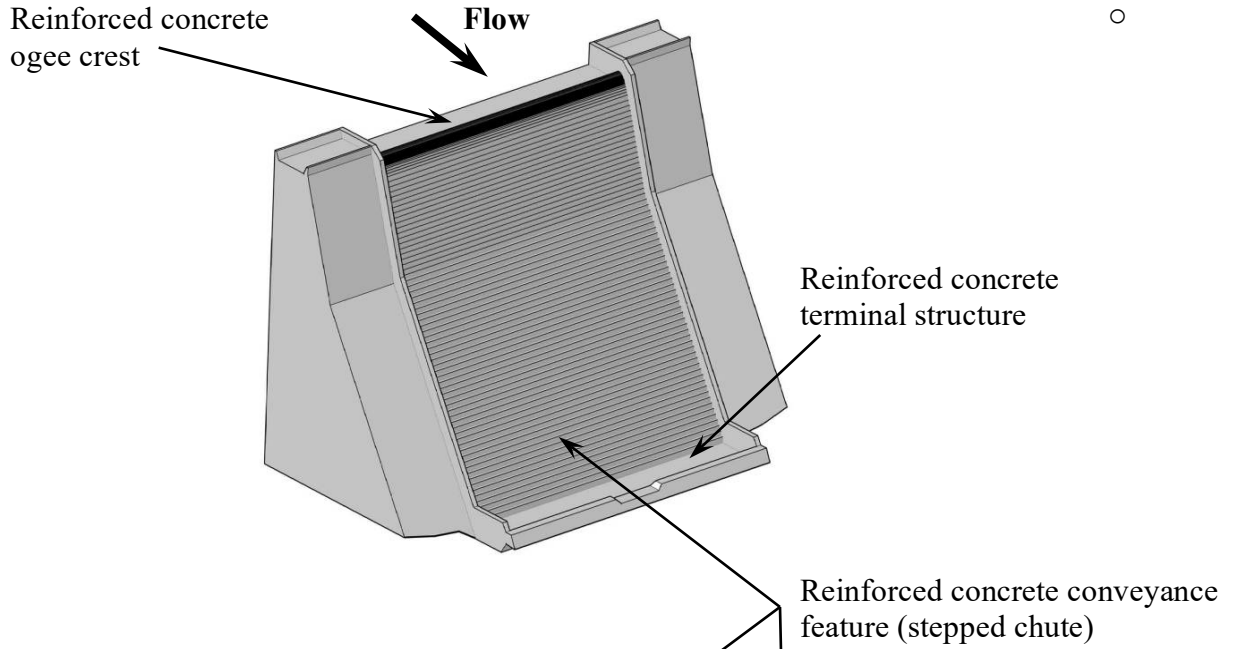
Figure 3.5.2.1-1. Chute (baffled apron) spillway.

**Design Standards No. 14: Appurtenant Structures for Dams  
(Spillways and Outlet Works)**



**Figure 3.5.2.1-2. Chute (grade control sill) spillway.**





Stepped service spillway integral with concrete dam, Santa Cruz Dam (New Mexico Stream Commission), New Mexico

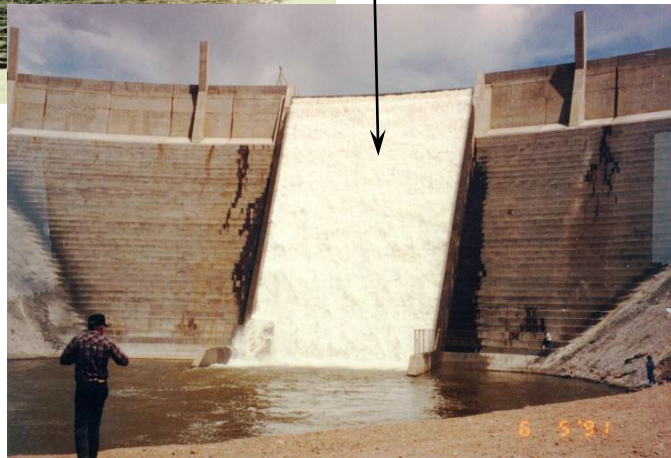
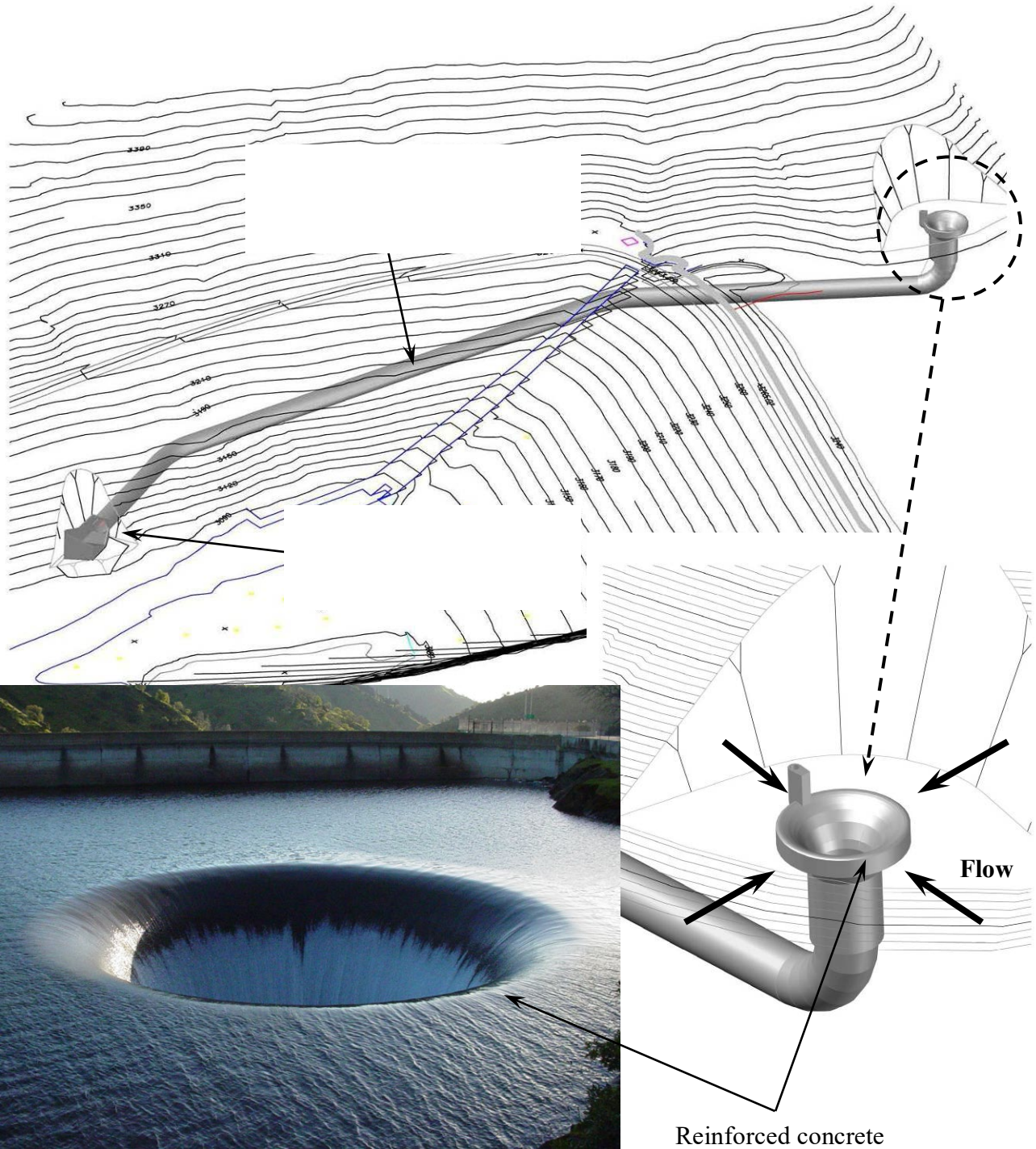


Figure 3.5.2.1-3. Chute (stepped chute) spillway.

**Design Standards No. 14: Appurtenant Structures for Dams  
(Spillways and Outlet Works)**



Morning glory service spillway, Monticello Dam, California

Reinforced concrete control structure (morning glory control structure)

**Figure 3.5.2.1-4. Drop inlet (morning glory) spillway.**

potential may be reduced as flow depth (relative to the step size) increases (due to skimming flows). Also, consideration should be given to evaluating the cavitation potential [11]. Examples of stepped spillways include the service spillway at Maricopa Water District's Camp Dyer Diversion Dam (concrete), the auxiliary spillway (Joint Federal Project) at Reclamation's Folsom Dam (composite), and the service spillway at Reclamation's Upper Stillwater Dam (concrete).

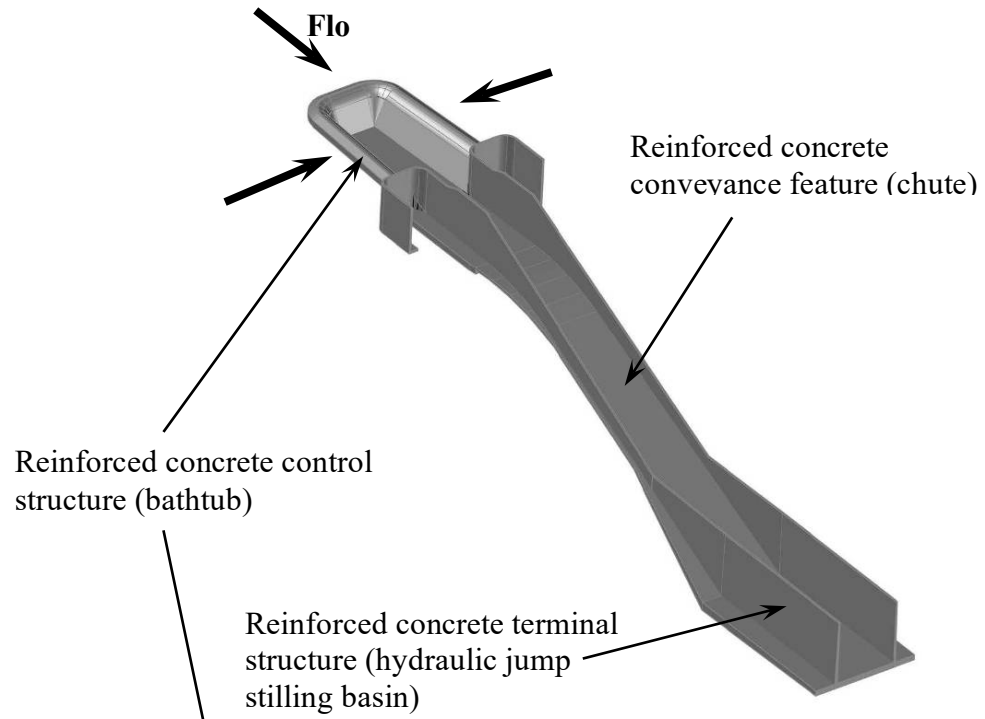
- **Various shaped weirs.** – This type of structure is suitable for service, auxiliary, and emergency spillways. The hydraulic control is established by various shaped weirs ranging from broad-crested to sharp-crested weirs to no weir (flat bottom or sloping channel). Various shaped weir control structures are not as efficient as an ogee crest control structure, but they still tend to have sizable reserve discharge capacity (i.e., increased discharge due to elevated RWS). Also, various shaped weir control structures are relatively free of operation and maintenance issues. This type of spillway is applicable to both concrete and embankment dams and can be gated or ungated. Examples of various shaped weir spillways include the auxiliary spillway at Reclamation's Deerfield Dam (embankment) and the service spillway at Reclamation's Lost Lake Dam (embankment).
- **Drop inlet spillways, including morning glory (shaft) and other drop inlet control structures** (see the spillway chart, figure 3.5.2-1). – These types of control structures are suited for service and auxiliary spillways.
  - **Morning glory control structures** (see figure 3.5.2.1-4). – This structure is a type of drop inlet spillway. This type of control structure should be considered when there is very limited space and there is adequate rock foundation. The morning glory spillway (sometimes referred to as a “shaft” spillway) has the potential of small to moderate discharge capacity and is used with conduit and tunnel conveyance features [12]. This type of spillway is applicable to concrete, embankment, and composite dams, and it can be gated or ungated. As hydraulic head on the crest increases, the flow transitions from crest control to throat (orifice) control and, in some cases, to pipe (pressure) control, resulting in reduced discharge efficiency. Morning glory spillways are typically designed to only operate in the crest control range. Larger discharges could result in adverse hydraulics in the downstream conduit or tunnel (slug and/or pressure flow). Also, this spillway type may be vulnerable to debris plugging. If heavy debris loads are anticipated during flood events, consider defensive measures to protect the control structure (such as debris booms) or consider other types of spillway control structures. Examples of morning glory spillways include the service spillways at Reclamation's Hungry

**Design Standards No. 14: Appurtenant Structures for Dams  
(Spillways and Outlet Works)**

Horse Dam (concrete), Ridgway Dam (embankment), Trinity Dam (embankment), and Owyhee Dam (concrete).

- **Other drop inlet spillways.** – This type of spillway is most applicable where there is a small amount of space to locate the control structure, there is adequate rock foundation, and the conveyance feature will be a conduit or tunnel. This type of spillway is applicable to concrete, embankment, and composite dams, and it can be gated or ungated. This spillway is very similar to an outlet works intake tower and may be in combination with an outlet works. This spillway has the potential of small discharge capacity. Larger discharges than design levels can result in hydraulic control shifts (crest to orifice and/or orifice to pipe control) that could result in adverse hydraulics in the downstream conduit or tunnel (slug and/or pressure flow). Also, this spillway type may be vulnerable to debris plugging. If heavy debris loads are anticipated during flood events, consider defensive measures to protect the control structure (such as debris booms) or consider other types of spillway control structures. Examples of other drop inlet spillways include the service spillways at Reclamation’s B.F. Sisk Dam (embankment) and Lake Sherburne Dam (embankment).
- **Double side-channel (bathtub)** (see figure 3.5.2.1-5) and **side-channel spillways** (see figure 3.5.2.1-6). – These types of control structures are suited for service and auxiliary spillways. Bathtub and side-channel control structures should be considered where there is limited space (insufficient space to accommodate a straight or curved ogee crest control structure) and there is adequate rock foundation. Also, these types of spillways are applicable to concrete, embankment, and composite dams, and they can be gated or ungated. These types of control structures have the potential for large discharge capacity and can be used with conveyance features including chutes, conduits, and tunnels. However, larger discharges than design levels can result in suppression and/or submergence of the crest and a reduction in the effective crest length. As the effective crest length is reduced, the spillway becomes less efficient (i.e., higher hydraulic heads may not significantly increase the discharge). Larger discharges could lead to downstream “throat” hydraulic control and adverse hydraulics, such as overtopping chute walls or pressurizing conduits or tunnels. A typical consideration is that a hydraulic jump occurs in the control structure before the flow enters the downstream conveyance feature (chute, conduit, or tunnel). This is done to establish a hydraulic control just downstream of the control structure, which facilitates the flow path down the conveyance feature (i.e., minimizes unstable flow in the conveyance features such as standing or cross waves). Examples of bathtub spillways include the service spillways at Reclamation’s Island Park Dam (embankment) and Fontenelle Dam (embankment). Examples of side-channel spillways include the service spillways at Reclamation’s Big Sandy Dam (embankment) and Paonia Dam (embankment).

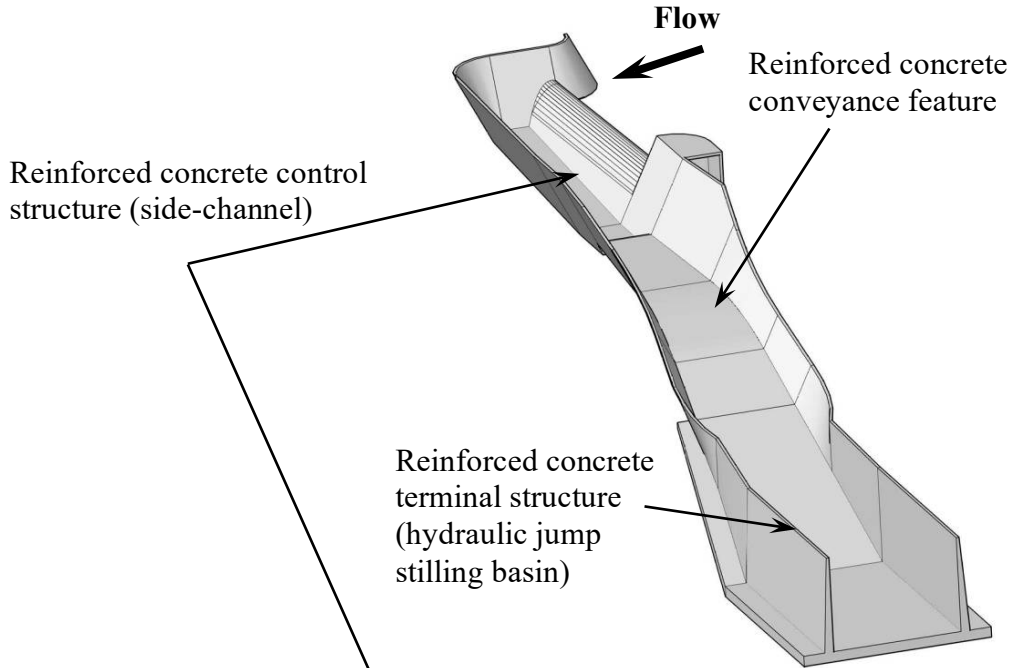




Bathtub service spillway, Fontenelle Dam, Wyoming.

Figure 3.5.2.1-5. Bathtub spillway.

**Design Standards No. 14: Appurtenant Structures for Dams  
(Spillways and Outlet Works)**

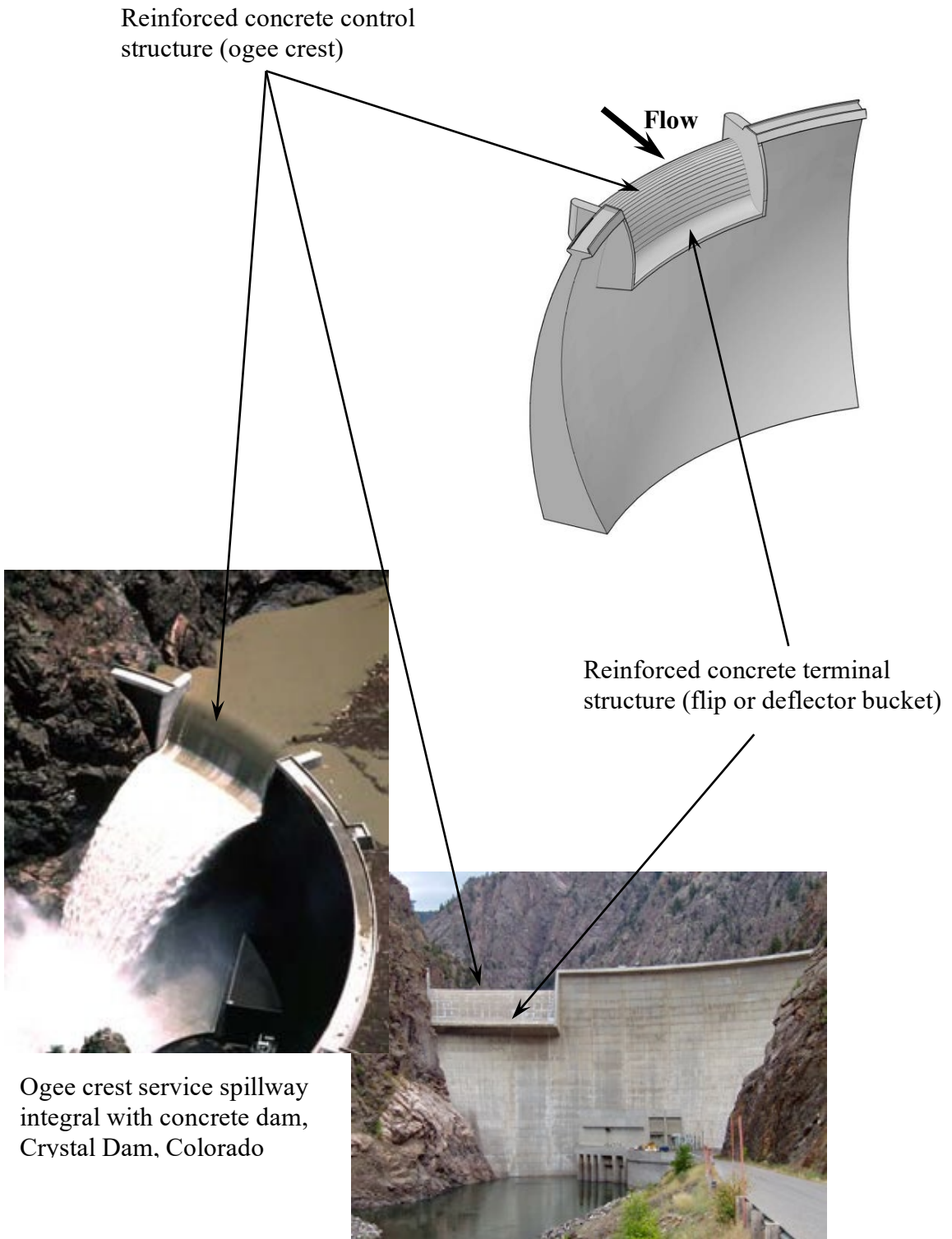


Side-channel service spillway, Paonia Dam, Colorado

**Figure 3.5.2.1-6. Side-channel spillway.**

- **Free overfall spillway including ogee crest, various shaped weirs, and straight drop control structures** (see the spillway chart, figure 3.5.2-1). – These types of spillways are structures where the flow drops freely from the crest. These types of control structures are suited for service, auxiliary, and emergency spillways.
  - **Ogee crest control structures** (see figure 3.5.2.1-7) and **various shaped weirs control structures**. – This type of control structure is suited to a concrete arch dam or to a crest that has a steep downstream face. This spillway can be gated or ungated. Flows may be free discharging (as is the case with a sharp-crested weir), or the flows may be supported along a narrow section of crest (such as an ogee crest that immediately terminates at a lip or flip that directs the free jet downstream). For free overfall spillways, the flow underneath should be ventilated sufficiently to prevent a pulsating, fluctuating jet. Of note, where no artificial protection (such as an armored plunge pool) is provided, scour of the streambeds may occur and form (erode) a plunge pool. Where erosion cannot be tolerated or needs to be controlled, an artificial pool can be constructed (for more details, see Section 3.6.4.2, “Terminal Structures,” in this chapter). Examples of free overfall (ogee crest) spillways are the service spillways at Reclamation’s Crystal Dam (concrete) and Pueblo Dam (composite). Example of free overflow (various shaped weir) are the modified dam crests of Reclamation’s Buffalo Bill Dam (concrete) and Gibson Dam (concrete), which serve as auxiliary spillways.
  - **Straight drop control structures**. – This type of control structure can be very effective over a wide range of tailwater depths and is applicable for low embankment dams. It consists principally of a straight wall (sharp crested) weir set at the upper end of a rectangular chute section, with an apron placed below streambed, and includes floor blocks and an end sill. This type of spillway is not applicable to high drops (large hydraulic head) on unstable foundations. Ordinarily, this spillway type should be limited to no more than a hydraulic head drop of 20 feet (distance between the reservoir and the tailwater surfaces). Examples of the free-flow (straight drop) spillway are the emergency spillway at Reclamation’s Trial Lake Dam (embankment) and the service spillway at the National Park Service’s PEEC’s Dam (embankment).

**Design Standards No. 14: Appurtenant Structures for Dams  
(Spillways and Outlet Works)**

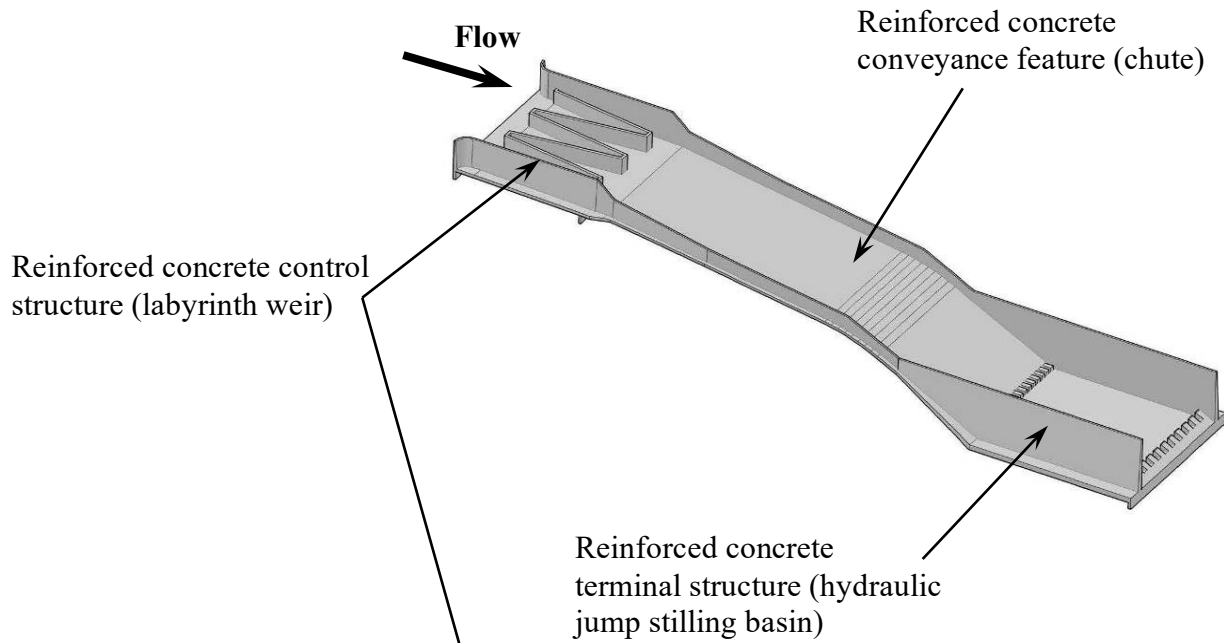


**Figure 3.5.2.1-7. Free overfall (ogee crest) spillway – Integrated with concrete dam.**



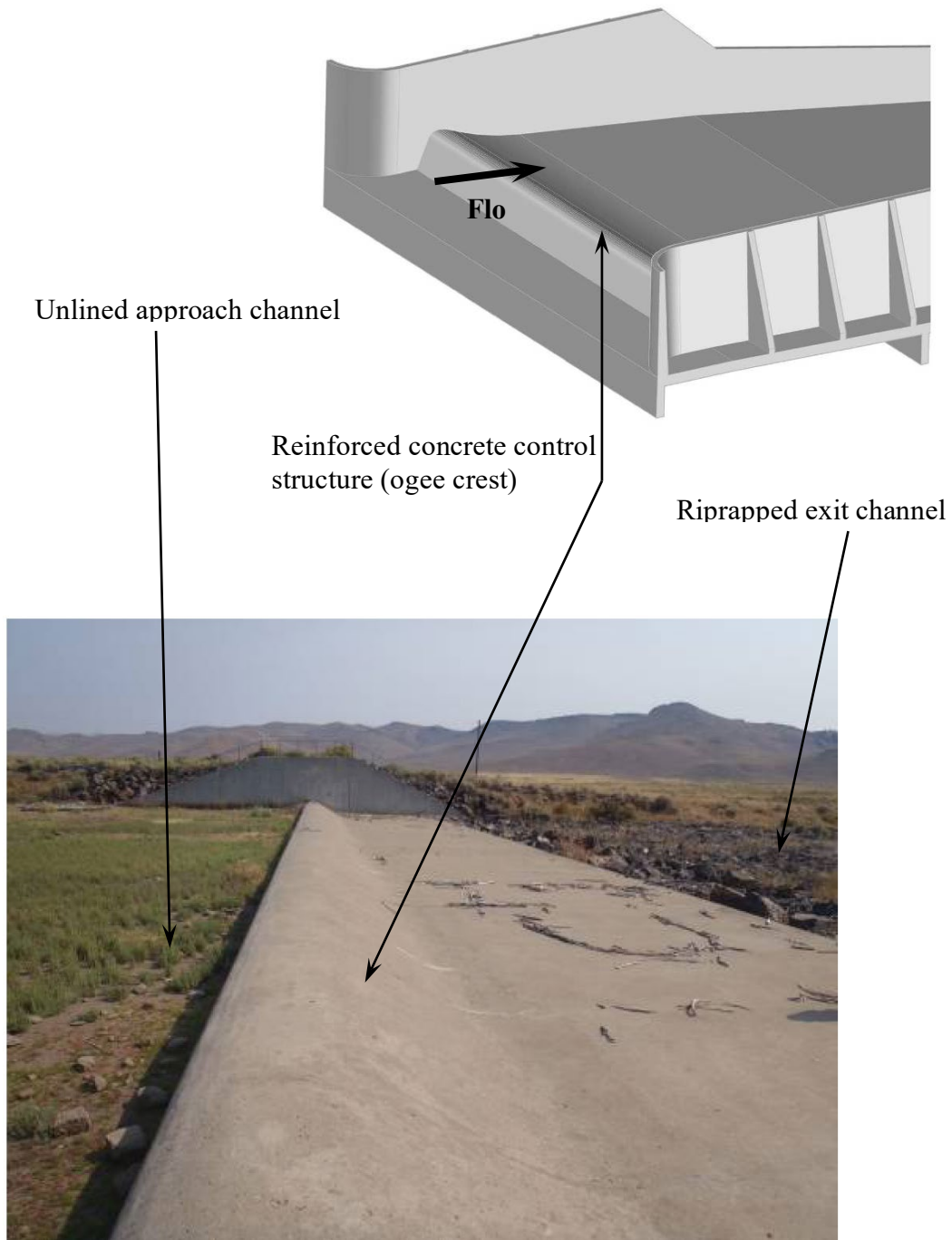
- **Labyrinth weir spillways** (see the spillway chart, figure 3.5.2-1). – These types of control structures (see figure 3.5.2.1-8) are suited for service and auxiliary spillways. The spillway provides added crest length for a given total crest width, so less hydraulic head (than a straight weir) is needed to pass a given discharge. The additional crest length is obtained by a series of trapezoidal, rectangular, or triangular walls within the total width. These walls are thin and cantilevered, vertical on the upstream face and steeply sloped on the downstream slope. Labyrinth weir control structures can be considered where space is limited, large discharge associated with small hydraulic head is needed, and there is adequate foundation (typically rock). However, larger hydraulic head than design levels can result in reduced discharge efficiencies (i.e., acting more like a broad-crested weir with reduced effective crest length rather than a sharp-crested weir with extended crest length). These types of control structures are used with chute conveyance features. An example of a labyrinth weir spillway is the service spillway at the New Mexico Interstate Stream Commission’s Ute Dam (embankment).
  
- **Ogee crest spillways include both straight and curved control structures** (see the spillway chart, figure 3.5.2-1). – These types of control structures are suited for service, auxiliary, and emergency spillways.
  - **Straight ogee control structures** (see figures 3.5.2.1-9). – This type of control structure tends to have considerable reserve discharge capacity (i.e., increased discharge due to elevated RWS). Also, straight ogee control structures are relatively free of operation and maintenance issues. This type of spillway is applicable to concrete, embankment, and composite dams, and it can be gated or ungated. Examples of straight ogee spillways include the service spillways at Reclamation’s Scofield Dam (embankment) and Sugar Pine Dam (embankment).
  
  - **Curved ogee control structures.** – This type of control structure is influenced by similar considerations as the straight ogee control structure. In addition, a curved control structure lends itself to rapid narrowing of the downstream conveyance feature, which helps to minimize excavation or allow transition to a tunnel conveyance feature. These types of spillway are applicable to concrete, embankment, and composite dams, and they can be gated or ungated. Examples of curved ogee spillways include the service spillways at Reclamation’s Casitas Dam (embankment) and Meeks Cabin Dam (embankment).

**Design Standards No. 14: Appurtenant Structures for Dams  
(Spillways and Outlet Works)**



Labyrinth weir service spillway (New Mexico Interstate Stream Commission), Ute Dam, New Mexico

**Figure 3.5.2.1-8. Labyrinth weir spillway.**



Ogee crest service spillway, Little Wood River Dam, Idaho

Figure 3.5.2.1-9. Ogee crest spillway.

**Design Standards No. 14: Appurtenant Structures for Dams  
(Spillways and Outlet Works)**

- **Orifice headwall spillways** (see the spillway chart, figure 3.5.2-1). – These types of control structures are suited for service, auxiliary, and emergency spillways. A variation of the orifice spillway, which has been successfully used in modifying existing straight ogee spillways, involves the construction of a headwall above the ogee crest or various shaped weirs. The opening between the bottom of the headwall and the crest creates orifice control during elevated RWSs. This type of modification has been very effective in limiting maximum spillway discharges to no more than the original design discharge capacity even with RWSs greater than the original design maximum RWS. Also, these types of spillways are applicable to concrete, embankment, and composite dams. An example includes the service spillway at Reclamation’s Glendo Dam.
  
- **Overtopping protection structures** (see the spillway chart, figure 3.5.2-1). – These types of structures are suited for auxiliary and emergency spillways. Overtopping protection (see figure 3.5.2.1-10) should only be considered if there are no other technically viable and cost-effective options to safely pass flood events. Overtopping protection can apply to concrete, embankment, and composite dams. Overtopping protection generally applies when there is some combination of remote chance of operation, physical or environmental constraints of constructing other alternatives, and/or prohibitive cost of other alternatives [9]. Overtopping protection applications could include the following:
  - **For embankment dams or embankment portion of composite dams:** Overtopping protection is placed over the embankment and at the downstream toe of the dam to limit erosion during overtopping. Overtopping protection materials include RCC, conventional or mass concrete, precast concrete blocks, gabions, riprap, turf reinforcement mats, vegetative cover, flow-through rockfill, reinforced rockfill, geomembranes, geocells, and fabric-formed concrete
  
  - **For concrete dams or concrete portion of composite dams:** Overtopping protection is typically placed on the abutments and at the downstream toe of the dam where erosion might compromise the dam foundation. Overtopping protection materials include RCC, conventional or mass concrete, foundation and abutment reinforcement, abutment, and plunge pool erosion protection

Examples of overtopping protection include auxiliary spillways at the U.S. Forest Service’s Vesuvius Dam (embankment), Reclamation’s Gibson Dam (concrete) and Buffalo Bill Dam (concrete), and the Bureau of Indian Affairs’ (BIA) Coolidge Dam (concrete). For more details and guidance, refer to the *Technical Manual: Overtopping Protection for Dams* [8].



Dam crest including splitter walls to aerate undernappe of overtopping flows

Right abutment armorment including rockbolting and concrete cap (left abutment also treated)



Overtopping protection for concrete dam (rockbolt and mass concrete armorment of right and left abutment and modified dam crest to serve as auxiliary spillway), Gibson Dam, Montana



RCC placement on downstream slope of embankment dam and forming hydraulic jump terminal structure at downstream toe of embankment dam

Concrete cutoff placed in trench on dam crest

Overtopping protection for embankment dam (RCC armorment of dam and abutment), Vesuvius Dam (U.S. Forest Service), Ohio

Figure 3.5.2.1-10. Overtopping protection spillway.

**Design Standards No. 14: Appurtenant Structures for Dams  
(Spillways and Outlet Works)**

- **Tunnel inlet spillways** (see the spillway chart, figure 3.5.2-1). - These types of control structures are suited for service and auxiliary spillways. The tunnel inlet spillways are applicable to situations where there is a small amount of space to locate the control structure, there is adequate rock foundation, and the conveyance feature will be a tunnel [12]. These types of spillways are applicable to concrete, embankment, and composite dams, and they can be gated or ungated. The control structure will include a geometry transition from a crest structure to a circular tunnel section. The tunnel inlet control structures have included ogee crests, side-channel and bathtub features, and various shaped weirs. Also, this spillway has the potential of moderate to large discharge capacity. Larger discharges than design levels can result in hydraulic control shifts (crest to orifice and/or orifice to pipe control) that could result in adverse hydraulics in the downstream tunnel (slug and/or pressure flow). Examples of tunnel inlet spillways include the service spillways at Reclamation's Kortes Dam (concrete) and Twitchell Dam (embankment).
- **Culvert spillways** (see the spillway chart, figure 3.5.2.-1). – These types of control structures (see figure 3.5.2.1-11) are suited for service, auxiliary, and emergency spillways. The culvert spillways are most applicable as appurtenant structures for low head dams (i.e., hydraulic head is 25 feet or less). Although there is simplicity and economy of construction, there are some significant potential concerns that must be fully addressed. These concerns include: (1) under certain conditions, the culvert may operate as a siphon, which can lead to adverse hydraulics (sudden surges and stoppages of flow, outflow exceeds inflow if operation shifts from inlet control to exit control, and significant vibrations that could damage the culvert and its foundation); (2) culverts on steep slopes flowing full can lead to negative pressures along the boundaries of the culvert, resulting in potential cavitation issues; and (3) if there are cracks or joints in low pressure areas, there is a possibility of drawing in soils surrounding the culvert [3, 13]. A culvert spillway does not have sizable reserve discharge capacity (i.e., increased discharge due to elevated RWS). Also, a culvert spillway is more susceptible to debris blockage. Examples of culvert spillways include the service spillway at Reclamation's Martinez Dam (embankment) and the emergency spillway at Reclamation's Weber Basin Combe Dam (embankment).

### Chapter 3: General Spillway Design Considerations



Culvert spillway entrance  
(reservoir side)

Culvert service spillway, Martinez Dam, California

Inside culvert spillway  
(looking upstream)



Figure 3.5.2.1-11. Culvert spillway.

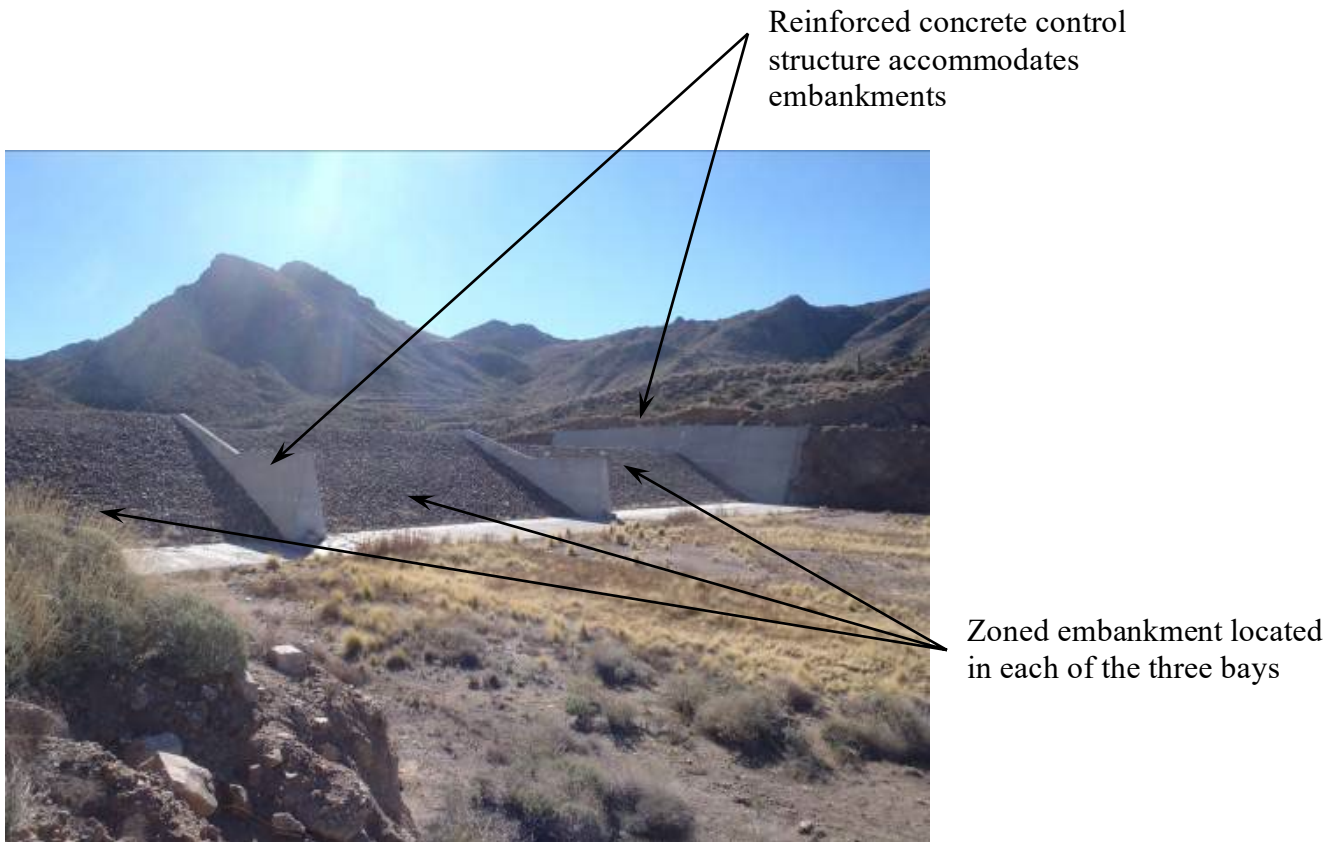
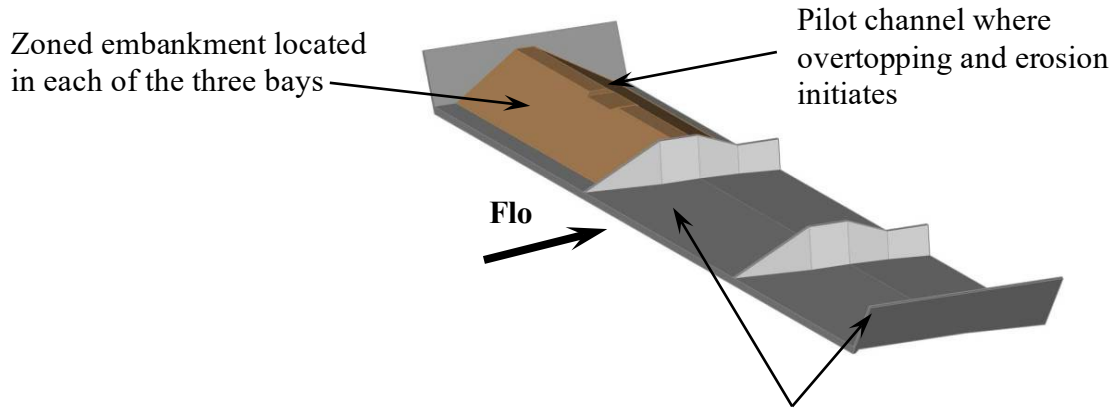
**Design Standards No. 14: Appurtenant Structures for Dams  
(Spillways and Outlet Works)**

**3.5.2.2 Controlled Spillways**

As noted previously for uncontrolled spillways, controlled spillways that are not integral with a concrete dam (i.e., located away from the dam on or through abutments, or on or through reservoir rim), existing topography must provide adequate space without excessive excavation. Also, the existing topography must allow appropriate orientation (alignment of the spillway between the reservoir and downstream river or stream) of the conveyance feature and terminal structure. Additionally, economics will come into play for all controlled spillways. Some of the more common controlled spillway types are discussed in the following text.

- **Fuseplug spillways** (see the spillway chart, figure 3.5.2-1). – These types of control structures are associated with staged releases and suited for auxiliary and emergency spillways. A fuseplug control structure (see figure 3.5.2.2-1) may include one or multiple bays containing the fuseplug embankments. The zoned embankments will be placed to a specified height and include a pilot channel through each embankment crest set to a specified elevation associated with a given flood event. The pilot channel(s) and the number of fuseplug embankments are set to limit the discharge for given ranges of RWSs. Fuseplug spillways should only operate during remote flood events, where more frequent flood events are accommodated by reservoir flood surcharge and discharge from service spillways and/or outlet works. An important consideration is the very large discharge capacity associated with operation from a small increase in RWS. The large amount of flow that could be released from an operating fuseplug must be carefully evaluated in terms of downstream impacts. Other considerations include evaluating and mitigating erosion potential both upstream (due to reservoir wave actions) and downstream of the fuseplug that could lead to headcutting and undermining the fuseplug control structure. Also, careful and thorough design and construction of the embankments are needed to ensure proper operation of the fuseplug spillway. Additionally, note that once a fuseplug spillway operates, the reservoir cannot be maintained above the control structure crest (base of the control structure containing the fuseplug embankments). This could result in the loss of reservoir storage until the fuseplug embankment(s) has been reconstructed. Finally, this type of spillway is applicable to concrete, embankment, and composite dams.



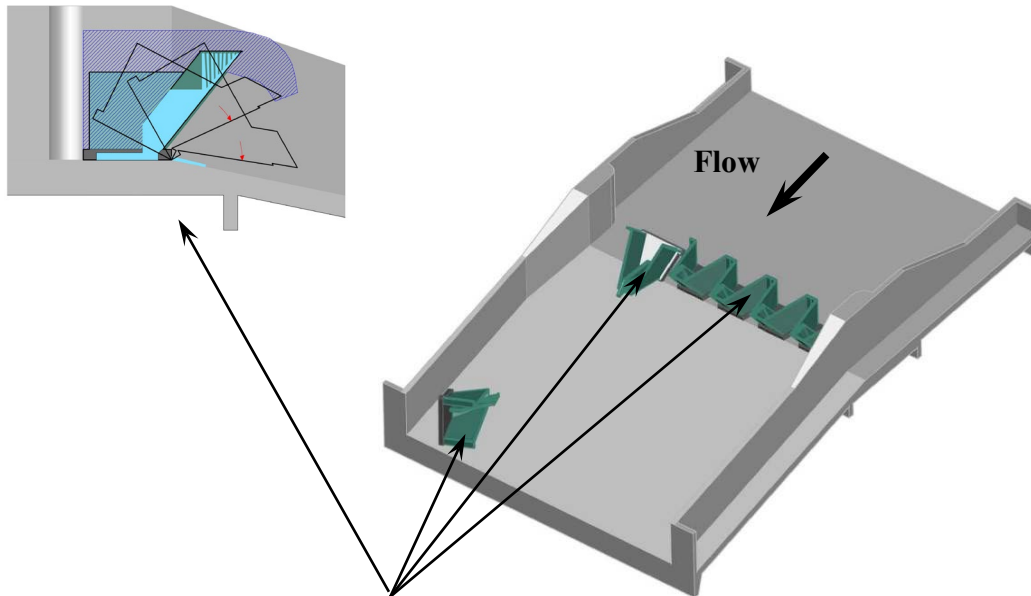


Three segment fuseplug auxiliary spillway, Reclamation dam

Figure 3.5.2.2-1. Fuseplug spillway.

**Design Standards No. 14: Appurtenant Structures for Dams  
(Spillways and Outlet Works)**

- **Fusegate spillways** (see the spillway chart, figure 3.5.2-1). – These types of control structures are associated with staged releases and suited for auxiliary and emergency spillways. Fusegate spillways are a proprietary system, and its inclusion in this design standard should not be viewed as an endorsement by Reclamation. This spillway type (see figure 3.5.2.2-2) provides a means of passing more frequent smaller flood events by overtopping the fusegates (via labyrinth or straight weir) and more remote larger flood events by tipping and displacing sections of the fusegate spillway [15]. This type of control structure provides the ability to increase (maximize) reservoir storage and/or discharge capacity. An important consideration is the potentially large discharge capacity associated with operation from a small increase in RWS (particularly during remote large flood events that result in tipping and displacing sections of the fusegate spillway). The amount of flow that could be released from an operating fusegate must be carefully evaluated in terms of downstream impacts. Another consideration includes evaluating and mitigating erosion potential downstream of the fusegate that could lead to headcutting and undermining the fusegate control structure. Also, as was noted for the fuseplug spillway, note that once a fusegate spillway operates, the reservoir cannot be maintained above the control structure crest (base of the control structure containing the fusegates). This could result in the loss of reservoir storage until the fusegates have been reinstalled or replaced. Finally, this type of spillway is applicable to concrete, embankment, and composite dams. Examples of fusegate spillways include auxiliary spillways at the U.S. Army Corps of Engineers' Terminus Dam (embankment) and Canton Dam (embankment).
- **Gated spillways.** – These types of control structures include drop inlet, free overfall, ogee crest, side-channel and bathtub, tunnel inlet, various shaped weirs, and orifice (see the spillway chart, figure 3.5.2-1). – These control structures are associated with regulated releases and suited for service, auxiliary, and emergency spillways. The most frequently used gates include radial gates, drum gates, wheel-mounted gates, and crest gates. Considerations include a firm foundation (typically rock), high degree of reliability of gate operation, limiting debris blockage potential, and favorable economics. In addition, gated spillways provide increased control of releases for a given RWS, allowing increased discharge where reservoir storage is limited, and/or to reduce the amount of RWS rise during a flood event. These considerations would apply to large volume inflows, where there is a relatively small reservoir storage capacity. Examples of these gated spillways include:



Fusegates, designed to act as a labyrinth weir for small amounts of overtopping flow, then become unstable, topple, and are displaced downstream for larger amounts of overtopping flow.



Fusegate spillway, Terminus Dam, California (courtesy of the U.S. Army Corps of Engineers, Sacramento District, Rick Poepelman).

Figure 3.5.2.2-2. Fusegate spillway.

**Design Standards No. 14: Appurtenant Structures for Dams  
(Spillways and Outlet Works)**

- **Gated drop inlet spillway.** – This type of control structure is mostly associated with a service spillway with radial gates. An example of a gated drop inlet spillway is Reclamation’s Gibson Dam (concrete). Other examples include the service spillways with ring gates at Reclamation’s Hungry Horse and Owyhee Dams (both concrete).
- **Gated free overfall spillway.** – This type of control structure is mostly associated with a service spillway with roller gates. An example of a gated free overall spillway is Reclamation’s Parker Dam (concrete).
- **Gated ogee crest spillways** (see figures 3.5.2.2-3 and 3.5.2.2-4). – This type of control structure is associated with a service and auxiliary spillway with gates. Examples of gated ogee crest spillways are Reclamation’s Shasta Dam (concrete) with drum gates and auxiliary spillway with radial gates at Reclamation’s Stewart Mountain Dam (concrete). Other examples include service and emergency spillways with radial gates at Reclamation’s Folsom Dam (composite) and the service spillway with fixed-wheel gates at Reclamation’s Keswick Dam (composite).
- **Gated side-channel spillway.** – This type of control structure is mostly associated with a service spillway with gates. An example of a gated side-channel spillway is Reclamation’s Arrowrock Dam (concrete), which has drum gates.
- **Gated tunnel inlet spillway** (see figure 3.5.2.2-5). – This type of control structure is mostly associated with a service spillway with gates. An example of a gated tunnel inlet spillway is Reclamation’s Seminoe Dam (concrete) with fixed wheel gates. Other examples include the service spillways with radial gates at Reclamation’s Glen Canyon Dam and the service spillways with drum gates at Reclamation’s Hoover Dam.
- **Gated various shaped weir spillway.** This type of control structure is mostly associated with a service spillway with gates. An example of a gated various shaped weir spillway is Reclamation’s Hyrum Dam (embankment) with radial gates.
- **Gated orifice spillway** (see the spillway chart, figure 3.5.2-1). – With this type of control structure, flow is typically released from the spillway by one of two approaches:

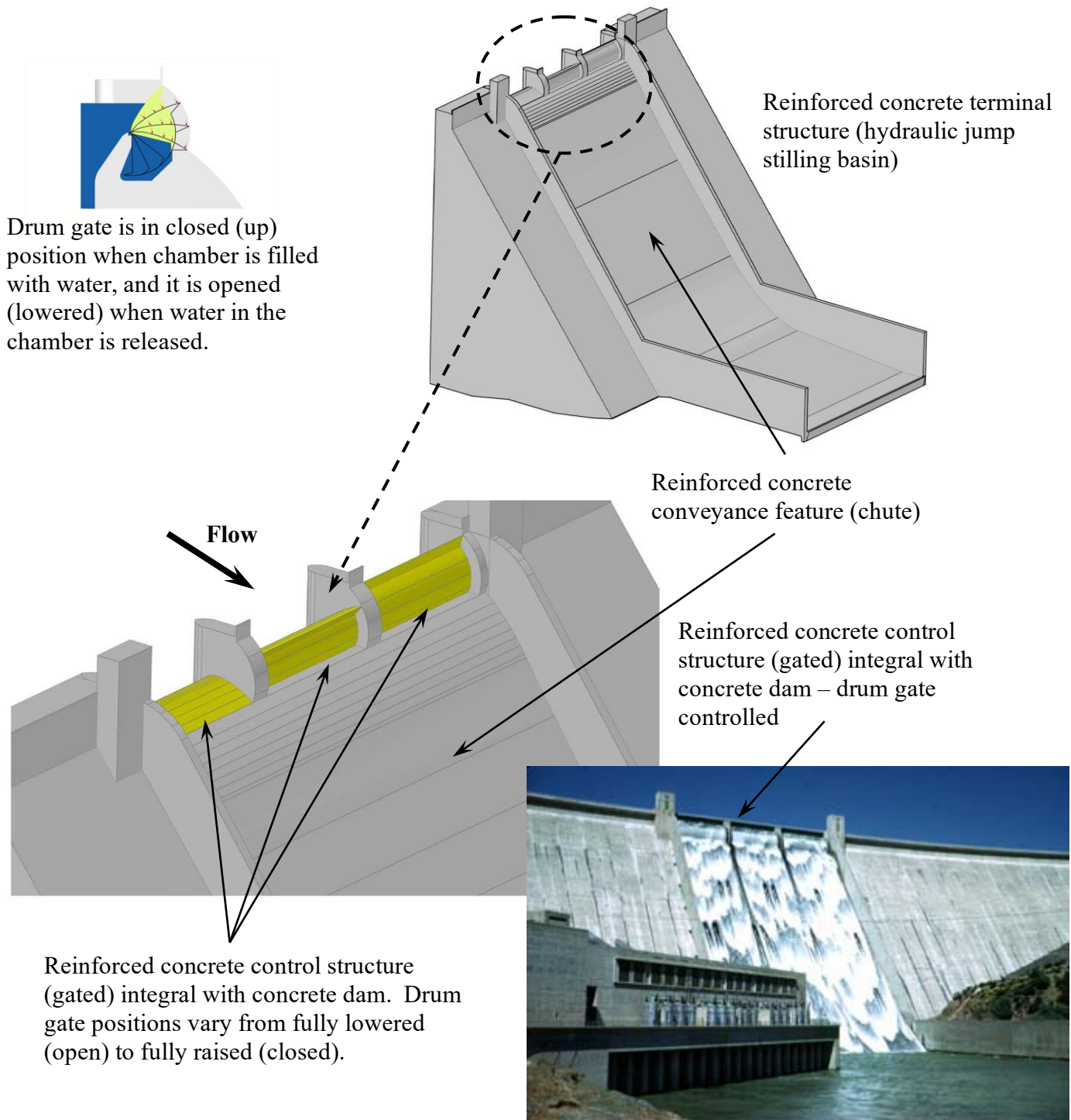
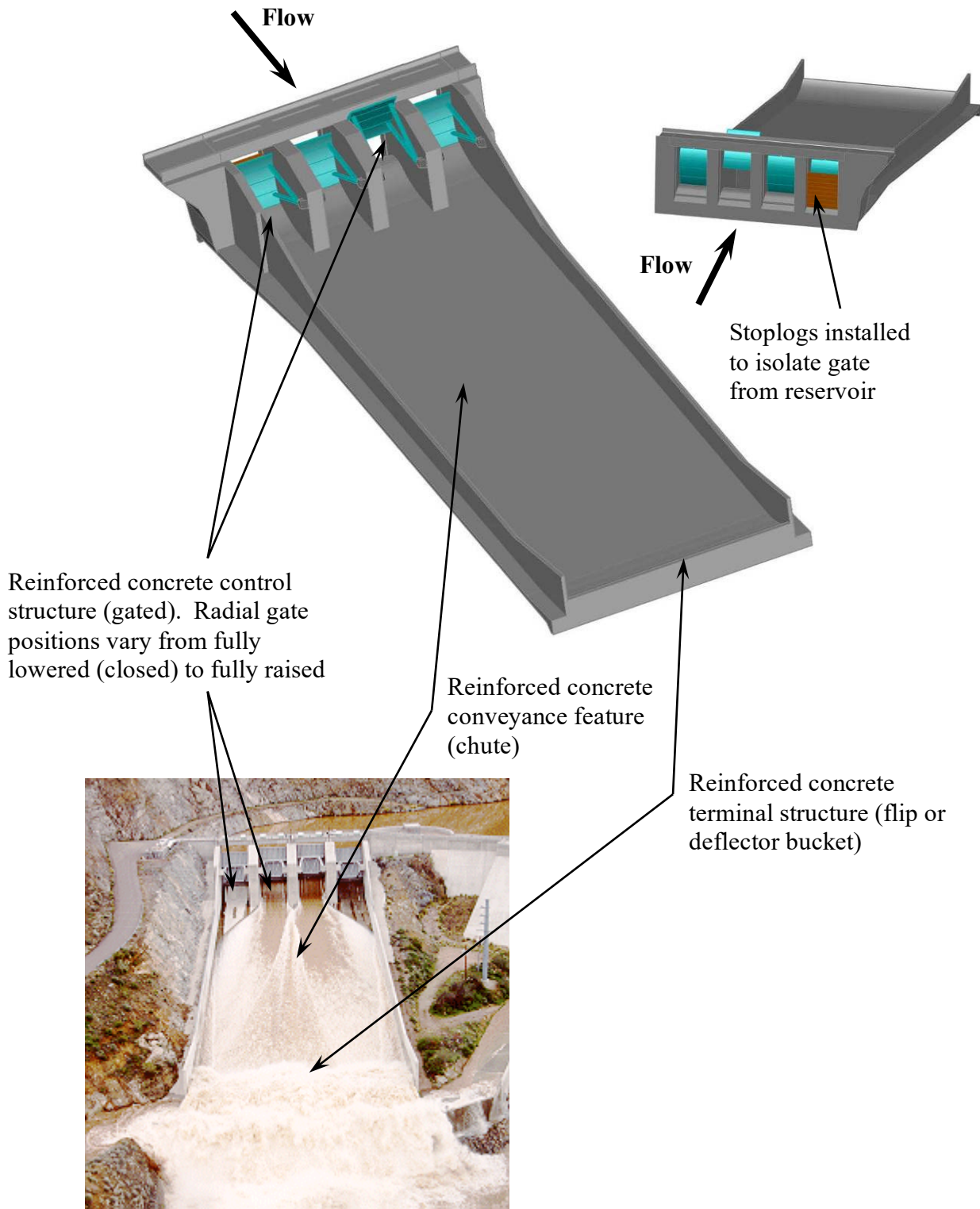


Figure 3.5.2.2-3. Gated (ogee crest) spillway – drum gates.

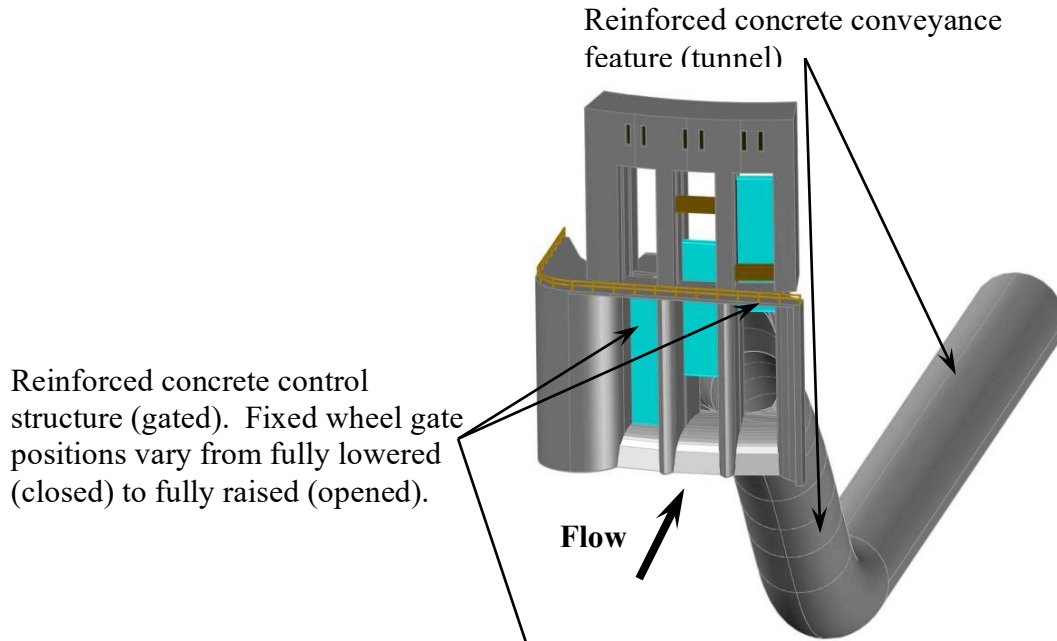


**Design Standards No. 14: Appurtenant Structures for Dams  
(Spillways and Outlet Works)**



Gated auxiliary spillway, Stewart Mountain Dam, Arizona

**Figure 3.5.2.2-4. Gated (ogee crest) spillway – radial gates.**



Tunnel inlet service spillway near right dam abutment, Seminole Dam, Wyoming

Figure 3.5.2.2-5. Tunnel inlet (gated) spillway.

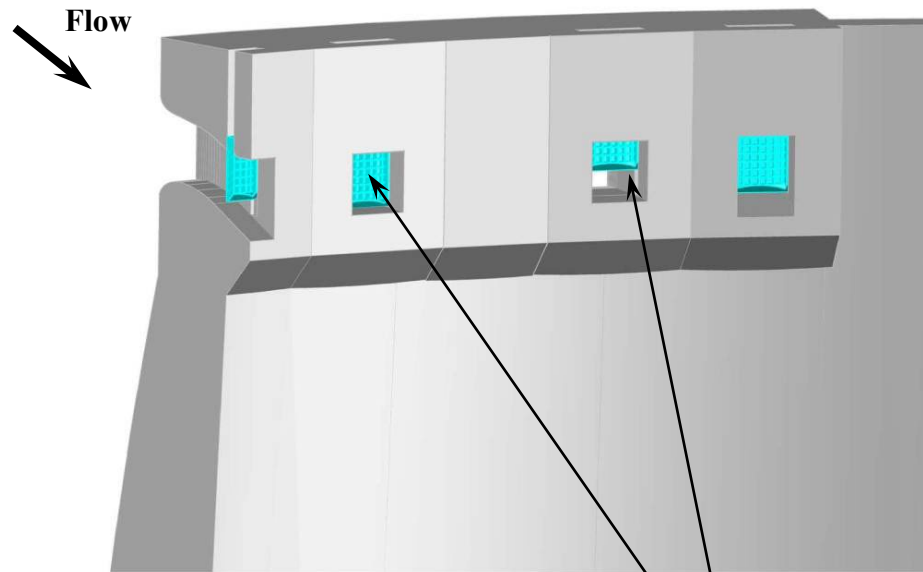
**Design Standards No. 14: Appurtenant Structures for Dams  
(Spillways and Outlet Works)**

- A free jet is released downstream of the gates and typically is stilled by a plunge pool.
- Flows will be released to a conveyance feature (such as a chute, conduit, or tunnel) and/or terminal structure.

Application of this control structure (see figure 3.5.2.2-6) is influenced by structural considerations of the dam and downstream foundation conditions (i.e., how erodible is the foundation?). Examples of orifice control structures are the service spillway located within the dam and with fixed-wheel gates at Reclamation's Morrow Point Dam (concrete), the service spillway located within the abutment of the dam and with top-seal radial gates at Reclamation's Buffalo Bill Dam (concrete), and the service and auxiliary spillway located on each abutment with top-seal radial gates at Reclamation's Theodore Roosevelt Dam (concrete).

- **Siphon spillway.** – These types of control structures are suited for service, auxiliary and emergency spillways, and/or outlet works. Siphon spillways have been used to help pass excess inflows (i.e., augment other hydraulic structure discharge capacity). These spillways can be designed to be self-priming or manually primed. The siphon has relatively small discharge capacity (pressurized operations), limited ability to drain the reservoir (limited hydrostatic head to less than atmospheric pressure, or about 30 feet), and is generally not suitable for cold weather climates (i.e., susceptible to ice blockage) [13, 14]. Examples of siphon spillways include the auxiliary spillway at Reclamation's McKay Dam (embankment) and the service spillway at Reclamation's Salmon Lake Dam (embankment). Also, siphon spillways (see figure 3.5.2.2-7) have been used to provide discharge capacity for small embankment dams to augment or replace existing outlet works [13]. Considerations include fairly rapid installation involving shallow excavation through dam crest, and the reservoir does not need to be drained. Examples of siphon spillways include the service spillways at the BIA's Horseshoe Cienega Dam (embankment) and Tsaile Dam (embankment).



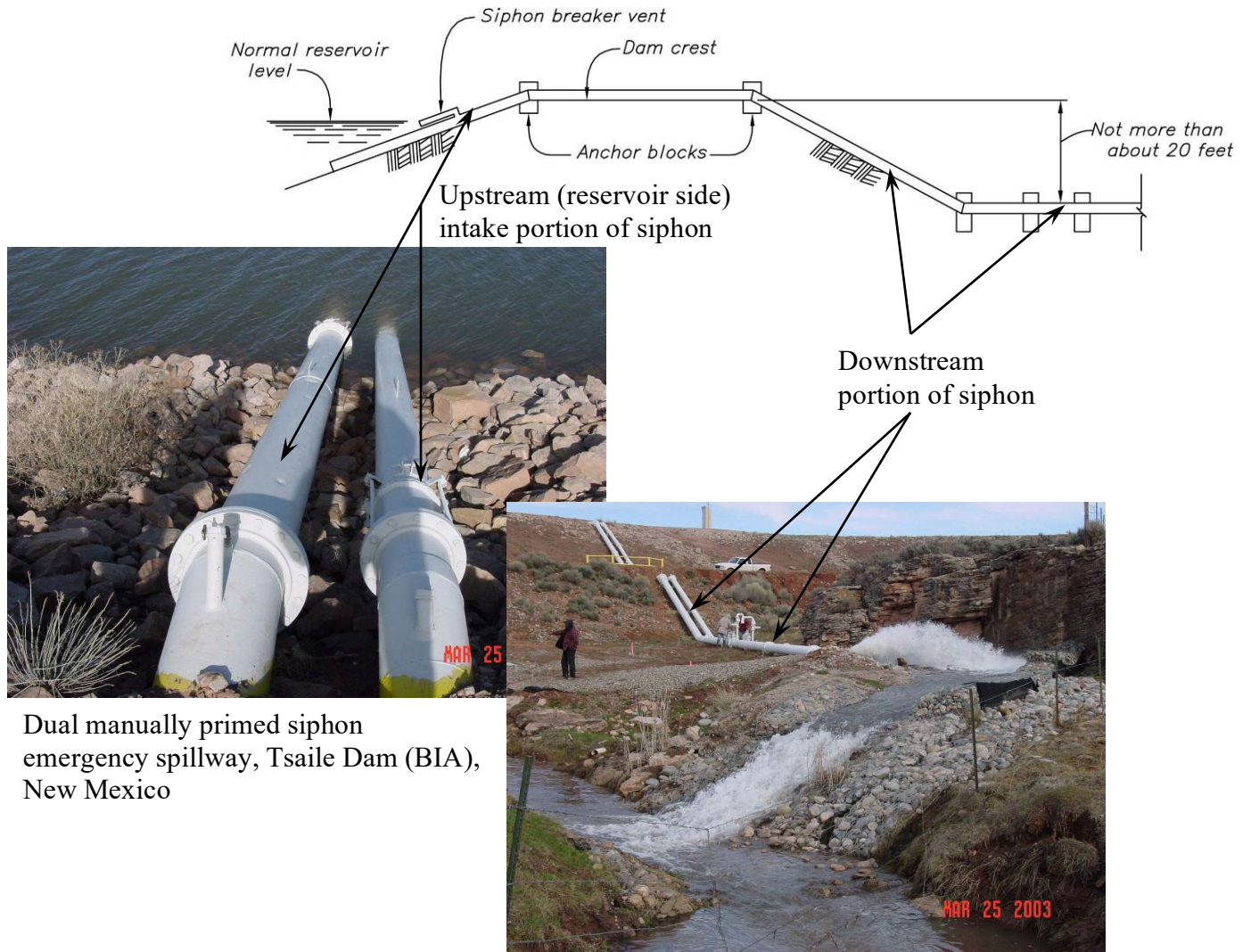


Reinforced concrete control structure (gated) integral with concrete dam. High pressure gate positions vary from fully lowered (closed) to fully raised. (opened).

Orifice service spillway integral with concrete dam, Morrow Point Dam, Colorado

Figure 3.5.2.2-6. Gated (orifice) spillway.

**Design Standards No. 14: Appurtenant Structures for Dams  
(Spillways and Outlet Works)**



Dual manually primed siphon emergency spillway, Tsale Dam (BIA), New Mexico

**Figure 3.5.2.2-7. Siphon spillway.**

**3.5.2.3 Spillway Types Summary**

Table 3.5.2.3-1 summarizes key factors that might help with selecting the spillway(s) type that is most suited for a given modification or new construction.

Chapter 3: General Spillway Design Considerations

Table 3.5.2.3-1. Spillway type summary

Spillway type	Spillway category			Foundation		Physical space <sup>1</sup>	Gated	Ungated	Hydraulic capacity <sup>2</sup>	Conveyance feature (compatibility)		
	Service	Auxiliary	Emergency	Rock	Soil					Chute	Conduit	Tunnel
<b>Controlled:</b>												
Fuseplug		X	X	X	X	Moderate			Modest to large	X		
Fusegate		X	X	X	X	Moderate			Medium to large	X		
Gated drop inlet	X	X		X		Small	X		Medium		X	X
Gated free overfall	X	X		X		Large	X		Modest to very large			
Gated ogee crest	X	X	X	X	X	Large	X		Modest to very large	X	X	X
Gated side-channel and bathtub	X	X		X		Moderate	X		Medium to large	X	X	X
Gated tunnel inlet	X	X		X		Small to moderate	X		Modest to very large			X
Gated various shaped weirs	X	X	X	X	X	Large	X		Small to very large	X		
Gated orifice	X	X	X	X		Moderate	X		Modest to very large <sup>3</sup>	X	X	X
Siphon	X	X	X	X	X	Small	X	X	Small to modest	X	X	
<b>Uncontrolled:</b>												
Chute - baffled apron	X	X	X	X	X	Large		X	Small to modest	X		
Chute - grade control sill	X	X	X	X	X	Large		X	Small to very large	X		
Chute - stepped chute	X	X		X	X	Large		X	Modest to very large	X		
Chute - various shaped weirs	X	X	X	X	X	Large		X	Small to very large	X	X	X
Culvert	X	X	X	X	X	Small		X	Small	X	X	X
Drop inlet - morning glory	X	X		X		Small		X	Modest to medium		X	X

**Design Standards No. 14: Appurtenant Structures for Dams  
(Spillways and Outlet Works)**

**Table 3.5.2.3-1. Spillway type summary**

Spillway type	Spillway category			Foundation		Physical space <sup>1</sup>	Gated	Ungated	Hydraulic capacity <sup>2</sup>	Conveyance feature (compatibility)		
	Service	Auxiliary	Emergency	Rock	Soil					Chute	Conduit	Tunnel
Drop inlet - other	X	X		X		Small		X	Small to modest		X	X
Bathtub	X	X		X		Moderate		X	Modest to medium	X	X	X
Free overfall - ogee crest or various shaped weir	X	X		X		Large		X	Modest to very large			
Free overfall - straight drop	X	X		X	X	Moderate		X	Small to modest	X		
Labyrinth weir	X	X		X	X	Moderate		X	Modest to large	X		
Straight or curved ogee crest	X	X	X	X	X	Large		X	Small to very large	X	X	X
Orifice headwall	X	X	X	X	X	Large		X	Small to medium	X	X	X
Side channel	X	X		X		Moderate		X	Modest to medium	X	X	X
Tunnel inlet	X	X		X		Small to moderate	X		Modest to large			X
Overtopping protection		X	X	X	X	Large		X	Medium to very large	X		

<sup>1</sup> **Physical space (requirement)** – Refers to the amount of surface area needed to construct spillway with space being relative to other spillways crest length and/or discharge capacity (i.e., a straight or curved ogee spillway with the same crest length needs more space than the morning glory spillway). See figure 3.5.2.3-1, which illustrates discharge capacity versus surface area (footprint) required to accommodate the spillway.

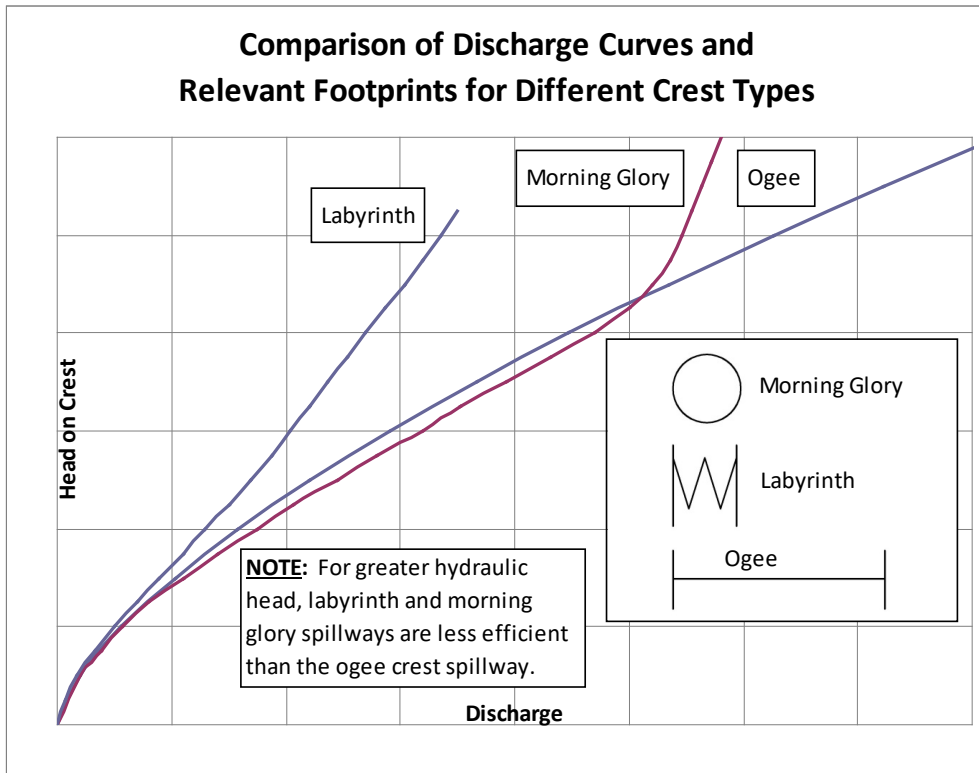
<sup>2</sup> **Hydraulic capacity** – Refers to the potential discharge capacity relative to other spillway types (i.e., an ogee crest has more hydraulic capacity potential than an orifice headwall spillway). Based on Reclamation’s inventory of spillways: small is ≤ 1,000 cubic feet per second (ft<sup>3</sup>/s); modest is > 1,000 ft<sup>3</sup>/s to ≤ 25,000 ft<sup>3</sup>/s; medium is > 25,000 ft<sup>3</sup>/s to ≤ 50,000 ft<sup>3</sup>/s; large is > 50,000 ft<sup>3</sup>/s to ≤ 100,000 ft<sup>3</sup>/s; and very large is > 100,000 ft<sup>3</sup>/s.

<sup>3</sup> **Orifice spillway types** – Large hydraulic capacity is associated with top-seal radial gate orifice, while moderate to small capacity is associated with headwall orifice.

Please note that this table summarizes common or typical applications of the spillway types. There have been (and could be) site-specific conditions that would result in an atypical application of a spillway type (see figure 3.5.2-1 for further details about atypical spillways).

**3.5.2.4 Considerations for Selecting Spillway Type and Size**

The general considerations for selecting the type and size of a new spillway and/or modifying an existing spillway include: project requirements (frequency and duration of operation, along with flood control requirements); dam type (concrete, embankment, composite); site conditions (topography, geology, and climate); hydrologic and seismic loading requirements; and diversion during construction requirements. As an example of evaluating these general considerations, the existing topography may indicate that there is limited space available for the spillway control structure. In this case, minimizing the footprint of the control structure is an important factor and is illustrated by figure 3.5.2.4-1, which compares discharge capacities to space requirements for three types of spillway control structures, each with a 200-foot crest length. Essential considerations for selecting the type and size of a new spillway and/or modifying an existing spillway are summarized in table 3.5.2.4-1.



**Figure 3.5.2.4-1. Comparison (200-foot crest length) – discharge capacities of uncontrolled spillways versus space (footprint) requirements.**

**Design Standards No. 14: Appurtenant Structures for Dams  
(Spillways and Outlet Works)**

**Table 3.5.2.4-1. Considerations for selecting spillway type and size**

Functional considerations	Safety considerations
1. Adequate discharge capacity to safely accommodate floods up to and including the IDF (see Chapter 2, “Hydrologic Considerations,” in this design standard for procedures for selecting the IDF).	1. High operating reliability.
2. Compatible with type of dam and/or dike.	2. Structurally capable to safely accommodate normal operations and earthquake loadings i.e., credible static and seismic PFMs’ risk estimate contributions to the total risks are acceptable (see Appendix B, “Potential Failure Modes (PFMs) for Spillways,” in this chapter).
3. Satisfies project requirements such as operational release requirements associated with the RCA, conditions after operation, discharge capacities of downstream dams, and safe channel capacity.	3. Hydraulically capable to safely release flows up to and including the IDF, i.e., credible hydrologic PFMs’ risk estimate contributions to the total risks are acceptable (see Appendix B, “Potential Failure Modes (PFMs) for Spillways,” in this chapter).
4. Effectively uses site topography and geology.	4. Hydrologic uncertainties are adequately addressed (i.e., robustness considerations are included – see Chapter 2, “Hydrologic Considerations,” in this design standard for preparing a robustness study).
5. Cost-effective structure.	

**3.5.2.5 Procedure for Selecting Spillway Type and Size**

A general procedure is used to select the type and size of a new spillway and/or modification of an existing spillway. This procedure is intended to provide guidance and may not be suited to every situation (i.e., in some cases, the selection of the spillway type and size can be done without performing all the steps). This procedure is integral with the IDF selection process for both existing and new dams as discussed in Chapter 2, “Hydrologic Considerations,” in this design standard. Specifically, the process includes: assuming an IDF; identifying and sizing the spillway in combination with reservoir surcharge that would safely accommodate the assumed IDF; estimating and determining if total risks are acceptable for the assumed IDF; and, if not, repeating the previous steps until the total risks are acceptable. The previously noted activity of **identifying and sizing the spillway in combination with reservoir surcharge** is outlined in table 3.5.2.5-1.

**Table 3.5.2.5-1. Procedure for selecting spillway type and size**

Step 1 <b>(Discharge-Storage Balance)</b>	Determine several combinations of spillway releases and reservoir flood surcharge storage required to safely accommodate the IDF.
Step 2 <b>(Control Structures)</b>	Identify preliminary spillway control structures that will meet the release requirements and any downstream release restrictions in combination with reservoir flood surcharge storage requirements to safely accommodate the IDF. This step may involve hydraulic analysis and design (flood routings), along with some preliminary structural and foundation analysis and design.
Step 3 <b>(Conveyance Feature and Terminal Structure)</b>	Combine suitable spillway conveyance features and terminal structures with each of the preliminary spillway control structures. This step may involve additional hydraulic analysis and design (water surface profiles), along with some preliminary structural and foundation analysis and design.
Step 4 <b>(Preliminary Layout)</b>	Lay out and evaluate the preliminary spillway alternatives to verify that size and type will work for site conditions and meet project requirements.
Step 5 <b>(Viable Spillways)</b>	Identify the preliminary spillways that will meet the release requirements in combination with surcharge storage requirements to safely accommodate the IDF.

The spillway type and size resulting from this procedure must be further evaluated to determine if total risks are acceptable. Once it has been determined that total risks are acceptable, evaluation of nonrisk factors (such as cost) is done to refine the spillway type and size. Final selection of the spillway type and size will be based on both risk and nonrisk factors. For more details concerning evaluating both risk and nonrisk factors, refer to Table 3.3.2.1, “Procedure for spillway design using quantitative risk analysis,” in this chapter.

### 3.5.3 Examples

Appendix A, “Examples: Spillway Location, Type, and Size,” in this chapter provides additional details for locating, typing, and sizing spillways. These examples include:

- **Example 1 – Existing Embankment Dam and Spillway.** Presents an overview of modifying the existing service spillway and locating, typing, and sizing a new auxiliary spillway.
- **Example 2 – New Embankment Dam and Spillway.** Presents an overview of locating, typing, and sizing a new service spillway associated with a new embankment dam.
- **Example 3 – New Concrete Dam and Spillway.** Presents an overview of locating, typing, and sizing a new service spillway associated with a new concrete dam.

## **3.6 General Hydraulic Considerations**

This section provides general hydraulic considerations for determining the type, location, and size of a modified or new spillway. Detailed hydraulic analysis and design can be found in Chapter 5, “Hydraulic Considerations for Spillways and Outlet Works,” in this design standard. As previously noted, unless otherwise specified, this chapter is applicable to the evaluation, analysis, and design of reinforced concrete, high velocity, and high flow spillways.

### **3.6.1 Discharge Capacity**

Once discharge capacity has been determined, it is usually presented in the form of drawings (discharge curves) and/or tables with discharges (cubic feet per second [ft<sup>3</sup>/s]) related to RWS elevations (feet [ft]). Estimating discharge capacity is based on either analytical methods or physical models. Analytical methods will typically be used for all levels of design (appraisal, feasibility, and final design levels), while physical models are typically limited to final design levels. Furthermore, physical models are usually employed for atypical designs involving unusual topography, geometry, and/or discharges or velocities that exceed experience levels.

Key in the estimation of discharge capacity is determining the hydraulic control(s) for the full range of spillway operation (i.e., full range of RWSs that would invoke spillway releases). Hydraulic controls include those discussed in the following sections.

#### **3.6.1.1 Crest Control (Uncontrolled or Free Flow)**

Crest control occurs when there is a free (water) surface and subcritical flow conditions<sup>14</sup> exist upstream of the control structure (such as an ogee crest structure), then pass through a critical state (i.e., when the Froude number<sup>15</sup> is equal to unity or when the specific energy<sup>16</sup> is at a minimum for a given discharge) at the control structure to a supercritical flow condition<sup>17</sup> downstream of the control structure. The governing equation for crest control is the weir equation (see figure 3.6.1.1-1 and table 3.6.1.5-1<sup>18</sup> for more details):

---

<sup>14</sup> Subcritical flow conditions occur when the Froude number is less than unity with low velocity flow described as tranquil and streaming [16].

<sup>15</sup> Froude number is defined as the ratio of inertial forces to gravity forces or average flow velocity ( $V$ ) divided by the square root of the product of gravity ( $g$ ) and hydraulic depth ( $D$ ), which is typically the wetted area ( $A$ ) divided by the top width ( $T$ ) of the water surface [16].

<sup>16</sup> Specific energy is defined as energy per pound of water measured from the channel bottom or the sum of pressure head ( $y$ ) and velocity head ( $V^2/2g$ ) [16].

<sup>17</sup> Supercritical flow conditions occur when the Froude number is greater than unity with high velocity flow described as rapid, shooting, and torrential [16].

<sup>18</sup> Table 3.6.1.5-1 appears later, in Section 3.6.1.5, “Discharge Capacity Design Procedures,” in this chapter.



$$Q = CLH^{\frac{3}{2}} \text{ (weir equation)}$$

- Where:
- $Q$  is the total discharge ( $\text{ft}^3/\text{s}$ ).
  - $H$  is the total hydraulic head above the spillway control structure crest (i.e., RWS elevation ( $z_{RWS}$ ) minus spillway control structure crest elevation ( $z_{CRT}$ ) (ft).
  - $C$  is the coefficient of discharge (initial suggested values include: 2.62 for broad-crested weir and dam overtopping, 3.3 for sharp-crested weir, and 3.7 for ogee crest). The coefficient of discharge is variable, depending on factors such as head ( $H$ ), crest shape (ogee, sharp-crested weir, broad-crested weir, etc.), control structure entrance (inlet structure, piers, etc.), approach channel depth ( $P$ ) and geometry, and downstream conditions (suppression, submergence).
  - $L$  is the effected crest length. See following text for estimating effective crest length (ft).

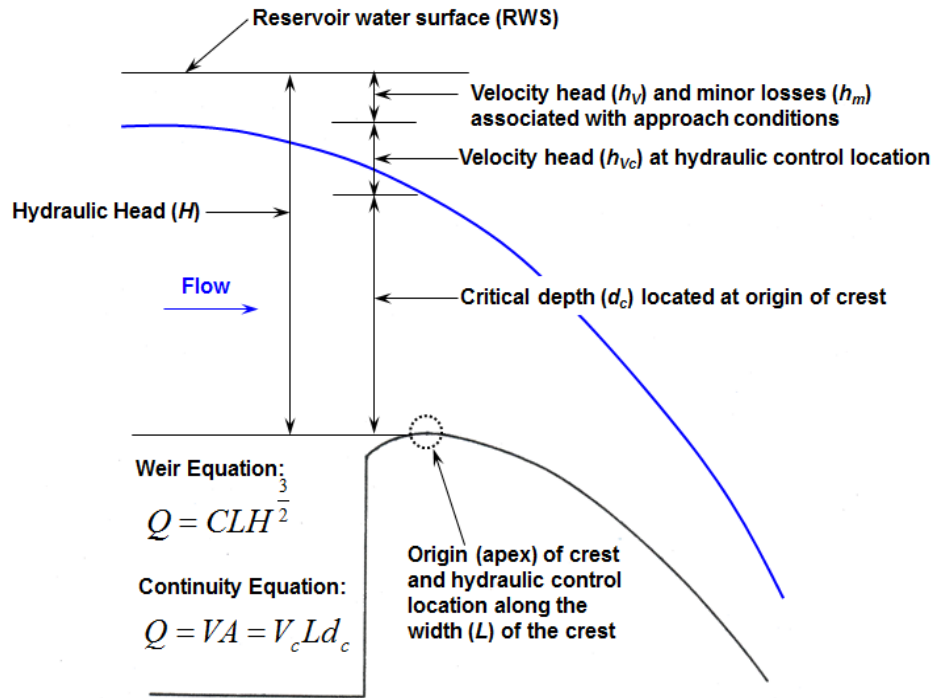


Figure 3.6.1.1-1.

## Design Standards No. 14: Appurtenant Structures for Dams (Spillways and Outlet Works)

For control structures with piers (typically used to support bridges over wide spillways or needed to partition spillway bays to accommodate gates, stoplogs, or bulkheads) and abutments that cause side contractions of flow, the effective crest length ( $L$ ) is less than the actual crest length ( $L'$ ). The effective crest length ( $L$ ) can be determined by the following equation:

$$L = L' - 2(Nk_p + k_a)H_o \text{ (effective crest length)}$$

Where:

- $L$  is the effective crest length (ft).
- $L'$  is the actual crest length (ft).
- $N$  is the number of piers.
- $H_o$  is the hydraulic design head (ft).
- $k_p$  is pier contraction coefficient (for design head,  $H_o$ , average values include: 0.2 for square-nosed piers with rounded corners; 0.1 for rounded-nosed piers; and 0.0 for pointed-nosed piers). For more details, refer to Chapter 5, “Hydraulic Considerations for Spillways and Outlet Works,” in this design standard.
- $k_a$  is abutment (end wall) contraction coefficient (for design head,  $H_o$ , average values include: 0.2 for square abutments with walls 90 degrees to flow direction; 0.1 for rounded abutments ( $0.5H_o \leq r \leq 0.15H_o$ ) with walls 90 degrees to flow direction; and 0.0 for rounded abutments ( $r > 0.5H_o$ ) and walls  $\leq 45$  degrees to flow direction). For more details, refer to Chapter 5, “Hydraulic Considerations for Spillways and Outlet Works,” in this design standard.

### 3.6.1.2 Orifice Control (Controlled Flow)

A constriction of the wetted area (such as a partially opened gate) between the upstream reservoir and downstream conveyance features (such as a chute or a conduit that is free flowing, not pressurized) creates a pressure and velocity change. The governing equation is derived from the Bernoulli<sup>19</sup> and continuity<sup>20</sup> equations (see figure 3.6.1.2-1 and table 3.6.1.5-2<sup>21</sup> for more details).

<sup>19</sup> Bernoulli or energy equation is based on the total energy or head ( $H$ ) being equal to the sum of the head above a datum ( $z_1 - El_{datum}$ ), the flow depth ( $d$ ) and the velocity head ( $V^2/2g$ ). With this in mind, and applying the principle of conservation of energy (continuity), the Bernoulli equation is defined as total head at point 1 ( $H_1 = z_1 + d_1 + V_1^2/2g$ ) equal to the total head at a downstream point 2, plus the loss of head ( $h_L$ ) between point 1 and point 2 ( $H_2 = z_2 + d_2 + V_2^2/2g + h_L$ ) [15].

<sup>20</sup> Continuity equation is based on the total discharge ( $Q$ ) being constant throughout, and discharge is the product of average velocity ( $V$ ) and wetted area ( $A$ ). Given this, the continuity equation is defined as the product of average velocity ( $V_1$ ) and wetted area ( $A_1$ ) at point 1 equal to the product of average velocity ( $V_2$ ) and wetted area ( $A_2$ ) at point 2 [16].

<sup>21</sup> Table 3.6.1.5-2 appears later, in Section 3.6.1.5, “Discharge Capacity Design Procedures,” in this chapter.

$$Q = CA\sqrt{2gH_a} \text{ (orifice equation)}$$

- Where:
- $Q$  is the total discharge (ft<sup>3</sup>/s).
  - $H_a$  is the hydraulic head above the orifice opening centerline elevation (i.e., RWS elevation ( $z_{RWS}$ ) minus orifice opening centerline elevation ( $z_{ORF}$ )) (ft).
  - $C$  is the coefficient of discharge (initial suggested value includes: 0.6 for vertical wall or wheel-mounted gate and 0.65 for radial gate, which is further detailed in *Design of Small Dams* [3]).
  - $A$  is area of orifice opening (i.e., product of the opening width ( $L$ ) and the minimum dimension ( $d$ ) between the top of the flow surface and the bottom of the opening) (ft<sup>2</sup>).
  - $g$  is the acceleration due to gravity (ft/s<sup>2</sup>).

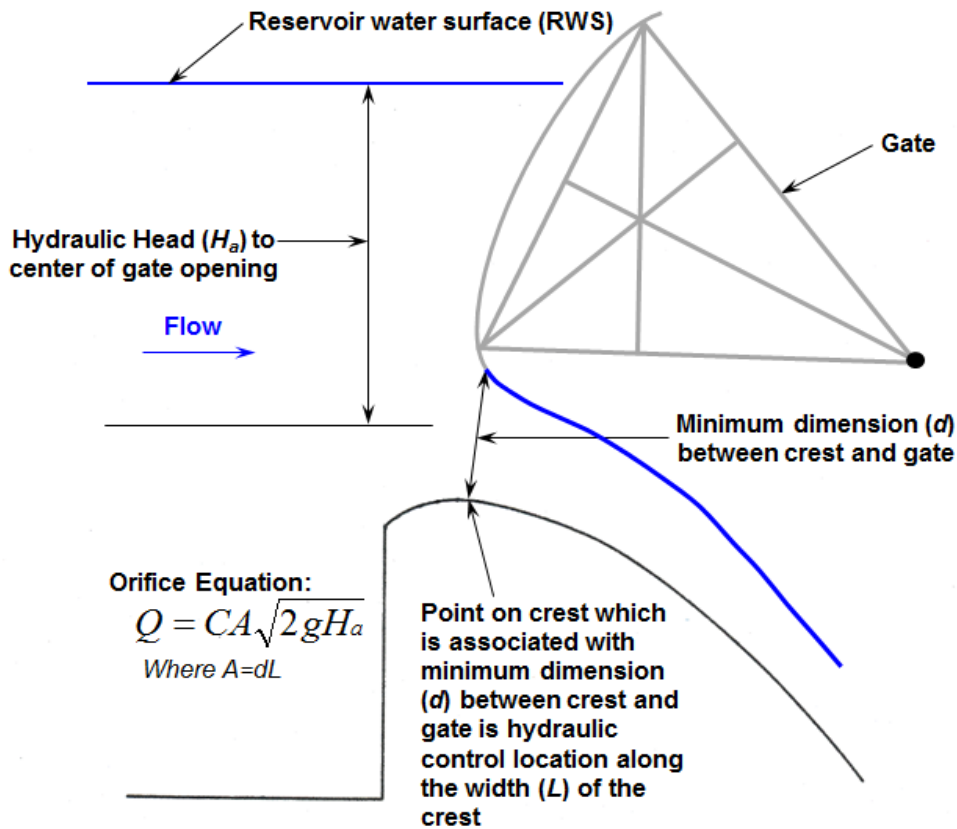


Figure 3.6.1.2-1. Orifice control.

**Design Standards No. 14: Appurtenant Structures for Dams  
(Spillways and Outlet Works)**

**3.6.1.3 Pipe Control (Pressurized Flow)**

Pipe control (pressurized flow) exists when rather than a free (water) surface, the water is confined in a closed system (such as a conduit or tunnel) between the upstream reservoir and downstream river channel, creating pressure and velocity change. The governing equation is derived from the Bernoulli and the continuity equations (see figure 3.6.1.3-1 and table 3.6.1.5-3<sup>22</sup> for more details).

$$Q_2 = Q_1 \sqrt{\frac{H_2}{H_1}} \Rightarrow Q_2 = K_p \sqrt{H_2} \text{ (form of Bernoulli equation)}$$

Where:

- $Q_1$  is the assumed total discharge (ft<sup>3</sup>/s).
- $Q_2$  is the calculated total discharge (ft<sup>3</sup>/s).
- $H_1$  is associated with  $Q_1$  and is the estimated total head equal to the difference between the RWS and the downstream reference elevation.  $H_1$  is further defined as the sum of the system head losses ( $h_{L1}$ ) and the exit velocity head ( $h_{v1}$ ) (ft).
- $H_2$  is associated with  $Q_2$  and is the estimated total head equal to the difference between the RWS and the downstream reference elevation.  $H_2$  is further defined as the sum of the system head losses ( $h_{L2}$ ) and the exit velocity head ( $h_{v2}$ ) (ft).
- $K_p$  is  $Q_1/(H_1)^{1/2}$

<sup>22</sup> Table 3.6.1.5-3 appears later, in section 3.6.1.5 of this chapter.

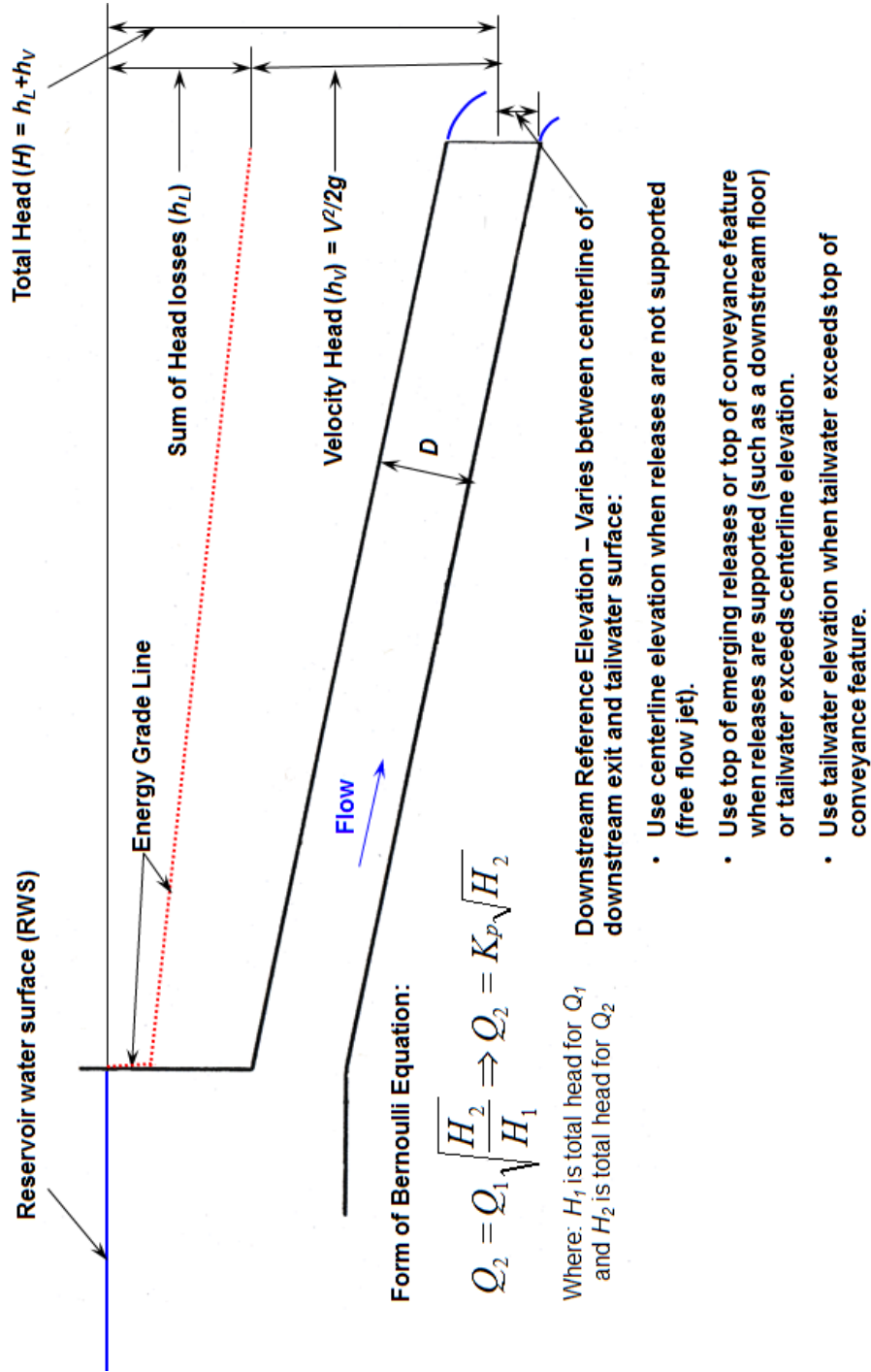


Figure 3.6.1.3-1. Pipe control.

**Design Standards No. 14: Appurtenant Structures for Dams  
(Spillways and Outlet Works)**

**3.6.1.4 Multiple Hydraulic Controls**

It is common for a spillway to have multiple hydraulic controls that occur for a portion of the full range of RWSs that invoke spillway releases. A number of examples include:

- The most common example is a gated spillway where the hydraulic control will either be crest control (gates raised above the water surface at the control structure) or orifice control (gates are below the water surface at the control structure).
- Another example is a morning glory spillway that would typically be designed for crest control for most of the range of RWSs that invoke releases up to the design maximum RWS.<sup>23</sup> If the design maximum RWS is exceeded (such as due to changes in the hydrologic loading; i.e., larger floods), the hydraulic control would initially shift from crest control to orifice control; and depending on the extent of increased RWS, the hydraulic control would shift from orifice control to pipe control.
- Culvert spillways could be subject to multiple hydraulic controls. The type of control will be dependent on slope, size, shape, length, and roughness of the culvert, along with inlet and outlet geometry. Generally speaking, if the ratio of the inlet hydraulic head ( $H$ ) over the diameter or height of the culvert ( $D$ ) is less than 1.5, and depending on the slope of the culvert, any one of the hydraulic controls could exist. For  $H/D > 1.5$ , pipe control would typically exist [3].

**3.6.1.5 Discharge Capacity Design Procedures**

When using analytical methods, the general steps for estimating the discharge capacity of a spillway when the hydraulic control is crest control are summarized in table 3.6.1.5-1.

Similar steps apply for estimating the discharge capacity of a spillway when the hydraulic control is orifice or pipe control. These steps are summarized in tables 3.6.1.5-2 and 3.6.1.5-3, respectively.

As previously noted, more than one hydraulic control may come into play during portions of the full range of RWSs that invoke spillway releases. In this case, a composite discharge capacity curve and/or table is developed, which combines discharge estimates from tables 3.6.1.5-1, 3.6.1.5-2, and 3.6.1.5-3. A discharge curve illustrating multiple hydraulic controls is presented by figure 3.6.1.5-1.

<sup>23</sup> For some morning glory spillways, the design includes a hydraulic control shift from crest to orifice near the maximum design RWS as long as the wetted area at the end of downstream conduit or tunnel does not exceed about 75 percent of the total cross-sectional area of the conduit or tunnel to ensure free flow conditions. This approach can result in a more economic control structure [3].

### Chapter 3: General Spillway Design Considerations

**Table 3.6.1.5-1. Procedure for estimating discharge capacity of a spillway for crest control conditions**

Step 1 <b>(Initial Assumptions)</b>	Assume a constant coefficient of discharge ( $C$ ), crest length ( $L$ ), and crest elevation. Typical assumed (initial) $C$ for a sharp crested weir is 3.3, ogee crest is 3.70, and for a broad crested weir such as a grade control sill or dam crest (overtopping), it is 2.62.
Step 2 <b>(Initial Discharge Curve)</b>	Compute an initial discharge capacity (curve and/or table) where: $Q = CLH^{\frac{3}{2}}$ (weir equation)  Where $H$ is the hydraulic head above the spillway control structure crest (i.e., RWS elevation ( $z_{RWS}$ ) – spillway control structure crest elevation ( $z_{CRT}$ )).
Step 3 <b>(Initial Flood Routings)</b>	Route floods (hydrographs) to determine the maximum RWS ( $z_{RWS}$ ) (see Section 3.6.2, “Flood Routing,” in this chapter for more details).
Step 4 <b>(Initial Design Head)</b>	Compute the initial design head ( $H_D$ ), where: $H_D = (z_{RWS} - z_{CRT}) \dots or \dots$  $H_D = 0.75(z_{RWS} - z_{CRT})$ for ogee crest only.  The reason for using 75% of the total maximum head as the design head is to develop a more efficient crest shape for small, more frequent spillway releases. For larger, remote releases, lower pressure may result (i.e., undernappe pulls away from the crest flow surface).
Step 5 <b>(Refine Coefficient of Discharge)</b>	Compute refined, variable coefficient of discharge ( $C$ ) using “datum” or nappe shape method found in <i>Design of Small Dams</i> [3], procedures for estimating discharge coefficients for irregular overflow shapes found in <i>Engineering Monograph No. 9</i> [17], or other references for sharp and broad-crested weirs [16,18,19], finite volume analysis (such as FLOW3D), or physical models. Also, additional details can be found in Chapter 5, “Hydraulic Considerations for Spillways and Outlet Works,” in this design standard.
Step 6 <b>(Revise Discharge Curve)</b>	Compute revised discharge capacity (curve and/or table).
Step 7 <b>(Revise Flood Routings)</b>	Reroute floods to determine the maximum RWS ( $z_{RWS}$ ) (see Section 3.6.2, “Flood Routing,” in this chapter for more details concerning flood routing).
Step 8 <b>(Finalize Discharge Curve and Flood Routings)</b>	If RWS (step 3) is 10% more or less than RWS (step 7), repeat steps 4 through 7. If RWS (step 3) is within 10% of the RWS (step 7), discharge capacity estimates are typically satisfactory.

**Design Standards No. 14: Appurtenant Structures for Dams  
(Spillways and Outlet Works)**

**Table 3.6.1.5-2. Procedure for estimating discharge capacity of a spillway for orifice control conditions**

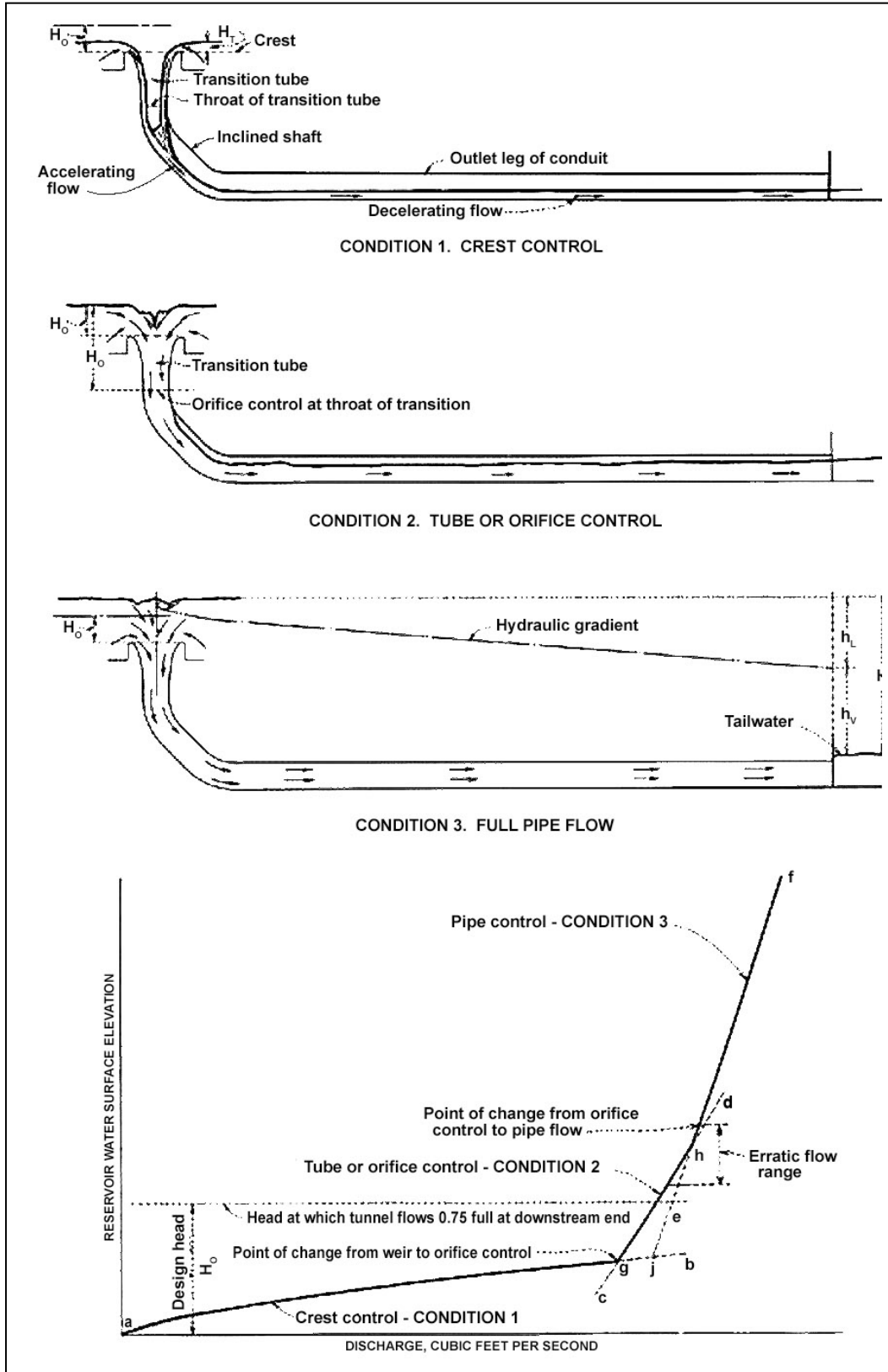
Step 1 <b>(Initial Assumptions)</b>	Assume a constant coefficient of discharge ( $C$ ), area of orifice opening ( $A$ ), and centerline elevation of orifice opening. A typical assumed (initial) $C$ for an orifice is 0.60 (refined $C$ from step 5 will typically be between 0.60 and 0.98, depending on the application, such as radial or wheel-mounted gate on ogee crest, head-wall over various shaped weirs, or a top-seal radial gate on chute control structure) [3].
Step 2 <b>(Initial Design Head)</b>	Compute an initial discharge capacity (curve and/or table) where:  $Q = CA\sqrt{2gH_a}$ (orifice equation)  Where $H_a$ is the hydraulic head above the orifice opening centerline elevation (i.e., RWS elevation ( $z_{RWS}$ ) – orifice opening centerline elevation ( $z_{ORF}$ )).
Step 3 <b>(Initial Flood Routings)</b>	Route floods (hydrographs) to determine the maximum RWS ( $z_{RWS}$ ) (see Section 3.6.2, “Flood Routing,” in this chapter for more details concerning flood routing).
Step 4 <b>(Initial Design Head)</b>	Compute the initial design head ( $H_D$ ), where:  $H_D = (z_{RWS} - z_{ORF})$
Step 5 <b>(Refine Coefficient of Discharge)</b>	Compute refined, variable coefficient of discharge ( $C$ ) using analytical methods found in <i>Design of Small Dams</i> [3] or other references [18, 20], finite volume analysis (such as FLOW3D), or physical models. Also, additional details can be found in Chapter 5, Hydraulic Considerations for Spillways and Outlet Works,” in this design standard.
Step 6 <b>(Revise Discharge Curve)</b>	Compute revised discharge capacity (curve and/or table).
Step 7 <b>(Revise Flood Routings)</b>	Reroute floods to determine the maximum RWS ( $z_{RWS}$ ) (see Section 3.6.2, “Flood Routing,” in this chapter for more details concerning flood routing).
Step 8 <b>(Finalize Discharge Curve and Flood Routings)</b>	If RWS (step 3) is 10% more or less than RWS (step 7), repeat steps 4 through 7. If RWS (step 3) is within 10% of the RWS (step 7), discharge capacity estimates are typically satisfactory.



**Table 3.6.1.5-3. Procedure for estimating discharge capacity of a spillway for pipe control conditions**

<p>Step 1 <b>(Initial Assumptions)</b></p>	<p>Assume pressure flow conditions and estimate head losses (<math>h_L</math>) between the reservoir and downstream river channel for an assumed discharge (<math>Q_1</math>). Additional details about typical head losses can be found in <i>Design of Small Dams</i> [3] and Chapter 5, “Hydraulic Considerations for Spillways and Outlet Works,” in this design standard.</p>
<p>Step 2 <b>(Initial Discharge Curve)</b></p>	<p>Compute total head (<math>H_1</math>) for assumed discharge (<math>Q_1</math>) and controls (gates/valves) are fully opened, where:</p> $H_1 = h_{v1} + \sum h_{L1}$ <p>Compute an initial discharge capacity (curve and/or table) where:</p> $Q_2 = Q_1 \sqrt{\frac{H_2}{H_1}} \text{ (form of Bernoulli equation)}$ <p>Where <math>H_2</math> is the total head between assumed RWS elevations (<math>z_{RWS}</math>) and downstream reference elevations (<math>z_{DS}</math>).</p> <p>Notes: General guidance for downstream reference elevation (<math>E_{DS}</math>) includes:</p> <ul style="list-style-type: none"> <li>• For unsupported flow (free-flow conditions), use centerline elevation of downstream exit.</li> <li>• For supported flow where tailwater is at or below centerline elevation of downstream exit, use crown (top) elevation of downstream exit.</li> <li>• For supported flow where tailwater is between centerline and top of downstream exit, use crown (top) elevation of downstream exit.</li> <li>• Where tailwater exceeds downstream crown (top) elevation of exit, use tailwater surface.</li> </ul> <p><math>z_{DS}</math> could vary with discharge, so some iteration may be needed to estimate the discharge (<math>Q_2</math>) for a given total head (<math>H_2</math>) (i.e., tailwater surface for 500 ft<sup>3</sup>/s versus 1,000 ft<sup>3</sup>/s could be very different). A key factor is estimating the discharge capacity of pressure flow conditions is the headlosses (<math>h_L</math>)</p>
<p>Step 3 <b>(Initial Flood Routings)</b></p>	<p>Route floods (hydrographs) to determine the maximum RWS (see Section 3.6.2, “Flood Routing,” in this chapter for more details concerning flood routing).</p>
<p>Step 4 <b>(Refine Head Losses)</b></p>	<p>Compute discharge (<math>Q_2</math>) using reasonable range of head losses to determine sensitivity of assumptions, which is based on analytical methods [3], or refine discharge estimate using finite volume analysis (such as FLOW3D) or physical models. Also, additional details can be found in Chapter 5, “Hydraulic Considerations for Spillways and Outlet Works,” in this design standard.</p>
<p>Step 5 <b>(Revised Discharge Curve)</b></p>	<p>Compute revised discharge capacity (curve and/or table).</p>
<p>Step 6 <b>(Revised Flood Routings)</b></p>	<p>Reroute floods to determine the maximum RWS (see Section 3.6.2, “Flood Routing,” in this chapter for more details concerning flood routing).</p>

**Design Standards No. 14: Appurtenant Structures for Dams  
(Spillways and Outlet Works)**



**Figure 3.6.1.5-1. Discharge curve – Multiple hydraulic controls [2].**

### 3.6.1.6 Existing Spillways

For existing spillways that are part of Reclamation’s inventory, discharge capacities have been determined and are typically well defined. The primary source for current (official) spillway discharge capacity information is the SOP for a given dam. The discharge capacities found in the SOP represent existing operating conditions and will typically provide adequate information unless operational and/or physical changes are being considered, such as raising the normal or flood-induced maximum RWSs, or modifying or replacing features of the existing spillway. In these cases, the existing discharge capacity should be reevaluated and (if needed) reestimated. Another source for existing spillway discharge capacities is physical (hydraulic) model study reports, which are available for many Reclamation facilities. Also, actual flow measurements from river gages, flow meters, or other measuring devices can be used to verify existing discharge curves or to develop discharge curves. General analytical procedures for evaluating and estimating the discharge capacity have been previously noted. Also, details on reevaluating and reestimating the discharge capacity are further addressed in Chapter 5, “Hydraulic Considerations for Spillways and Outlet Works,” in this design standard.

For existing spillways that are not part of Reclamation’s inventory, discharge capacity information may not always be available. If this is the case, estimates will be developed using either analytical methods or physical models. As previously noted, the hydraulic control(s) for the existing spillway is determined so that the discharge capacities can be estimated. General procedures for evaluating and estimating the discharge capacity have been previously noted. Details on evaluating and estimating the discharge capacity are further addressed in Chapter 5, “Hydraulic Considerations for Spillways and Outlet Works,” in this design standard.

Finally, it is stressed that when evaluating existing spillway discharge capacity, attention should be given to the possibility of a hydraulic control shift if hydraulic heads greater than the maximum design head could occur.

### 3.6.1.7 New Spillways

For new spillways, discharge capacity estimates will be developed using either analytical methods or physical models. As previously noted, the hydraulic control(s) for the new spillway is first determined. Then, discharge capacities are estimated. General procedures for evaluating and estimating the discharge capacity are previously noted. Details on evaluating and estimating the discharge capacity are further addressed in Chapter 5, “Hydraulic Considerations for Spillways and Outlet Works,” in this design standard.

## **3.6.2 Flood Routing**

Reservoir flood routings are typically based on one-dimensional level pool conditions (sometimes referred to as static flood routings) where the change in reservoir storage is the difference between inflow and outflow during a given time interval. Key considerations for preparing a flood routing are discussed in the following sections.

### **3.6.2.1 Current Data**

For an existing dam, the best source for current data is usually the SOP. However, data may need to be collected, created, and/or extended if current data are not available or sufficient. For a new dam, data will be collected and/or developed. These data include:

- **Reservoir storage (acre-feet) versus reservoir elevation (feet)** portrayed as a curve or in tabular form. If reservoir storage data and/or existing topography are not sufficient, an acceptable method of extending (extrapolating) reservoir storage is by assuming a linear (straight-line) extension of the reservoir surface area curve to higher elevations. The incremental reservoir storage can be estimated by using the prismoidal equation<sup>24</sup> for a given depth bounded by two RWSs and the reservoir surface areas associated with these RWSs. For existing reservoirs, sediment accumulation may affect the available reservoir storage for the flood routings.
- **Reservoir operations**, which could influence when and how hydraulic structure releases are made.
- **Discharge capacity for each appurtenant structure** (including dam crest overtopping conditions), which will be involved in evacuation first filling operations (see Section 3.6.1, “Discharge Capacity,” in this chapter for more details), including dam/dike crests where overtopping is possible.

---

<sup>24</sup> Prismoidal equation -  $\Delta V = (\Delta H/6)(A_1 + A_2 + 4A_M)$ , where:  $\Delta V$  is incremental storage (acre-feet);  $\Delta H$  is depth between two RWS elevations (feet);  $A_1$  and  $A_2$  are the reservoir surface areas which bound the incremental depth (acres); and  $A_M$  is the reservoir surface area associated with the midpoint RWS within the incremental depth (acres). **Note:** The average end area method for estimating volume,  $\Delta V = (\Delta H/2)(A_1 + A_2)$ , should only be used when a prismoid varies in only one direction (like a wedge). If the prismoid varies in two or three directions (such as a pyramid), the average end area method will either underestimate or overestimate the correct volume and should not be used (an example of this is a truncated pyramid shape or frustum, that defines splitter walls in a segmented fuseplug spillway control structure – the walls slope in two directions).

### 3.6.2.2 Starting RWS

The starting RWS elevation is perhaps the most sensitive variable that can be adjusted in a flood routing. General guidelines include the following:

- **For reservoirs without flood control** (refer to the SOP for any specific requirements for an existing dam). - If not noted in the SOP for an existing dam, or if dealing with a new dam, the maximum starting RWS will usually be based on the maximum normal conditions, typically the top of active conservation. Please note that although the maximum normal RWS is typically assumed for design purposes, a range of starting RWS will need to be evaluated when dealing with quantitative risk analysis.
- **For reservoirs with flood control** (again refer to the SOP for any specific requirements for an existing dam). - If not noted in the SOP for an existing dam or if dealing with a new dam, the maximum flood control reservation RWS (RWS typically less than the maximum normal conditions which provides additional flood storage space in the reservoir) will be used as a minimum and the maximum normal conditions (the top of active conservation and/or top of joint use) will be used as a maximum. As previously noted, a range of starting RWSs will need to be evaluated for quantitative risk analysis.

### 3.6.2.3 Starting Time

The starting time for routing a hydrograph can change the resulting maximum RWS and the appurtenant structures discharge. General guidelines are summarized in the following bullets:

- **For reservoirs without flood control and hydrographs without antecedent flood conditions** (i.e., inflow is greater than base flow conditions). - The starting RWS is maintained until inflow exceeds the discharge capacity of the appurtenant structures (typically referred to as “outflow equals inflow”).
- **For reservoirs without flood control and hydrographs with antecedent flood conditions.** - The starting time is usually set at the beginning of the flood event (typically referred to as “time equals zero”).
- **For reservoirs with flood control and hydrographs with or without antecedent flood conditions.** - Outflow is restricted to conform with flood damage reduction requirements up to a specified RWS or a range of RWSs (i.e., rule curves), above which there are typically no discharge restrictions.

**Design Standards No. 14: Appurtenant Structures for Dams  
(Spillways and Outlet Works)**

**3.6.2.4 Time Increments**

To ensure that the maximum RWS elevation and/or maximum appurtenant structures discharge are determined, use 1 hour (or smaller) time increments before and after the maximum RWS is reached (note: this may require multiple routings to identify the timeframe when the maximum RWS occurs, then refine time increments during this timeframe, possibly in the range of 3 to 6 hours before and after the maximum RWS occurs). Time increments as small as 15 minutes may be needed for short duration hydrographs such as a thunderstorm event. The intent is to determine when outflow equals inflow at the maximum RWS, and when outflow exceeds inflow as the reservoir is drawn down.

**3.6.2.5 Complete Routings**

All flood routings should be run until the RWS elevation recedes to the starting RWS or has reached a steady state condition (i.e., does not continue to recede due to outflow equals inflow). This can provide durations for spillway operation and/or dam overtopping, which is used for assessment purposes (such as evaluating adverse hydraulic potential and/or identifying flow surface tolerances). It should be highlighted for hydrographs with multiple peaks, and ensure the routings extend past the last peak.

**3.6.2.6 Robustness (Freeboard) Study**

As discussed in Chapter 2, “Hydrologic Considerations,” in this design standard, uncertainties are evaluated and addressed by a robustness study. These uncertainties may be related to the method of estimating floods, reservoir and dam operations, gated spillway or outlet works misoperations, reduction of spillway or outlet works discharge capacity due to debris and other mechanisms, and future events associated with upstream and downstream developments. To account for these uncertainties, plausible “what-if” scenarios are evaluated by simulating the what-if conditions in the flood routings. These scenarios could create elevated maximum RWSs above the design maximum RWS, which will be used to establish freeboard requirements for either an existing or a new dam. Refer to Chapter 2, “Hydrologic Considerations,” in this design standard for the robustness (freeboard) study details and examples.

**3.6.3 Reservoir Evacuation and First Filling**

Important considerations for storage and multipurpose dams include the ability to evacuate (lower or drain) the reservoir in a timely manner and control first filling rates of a reservoir. For the most part, the key hydraulic structure used to lower the reservoir in a timely manner or control the rise of the reservoir is the outlet works. However, all hydraulic structures, including the outlet works, gated spillways, and power penstocks, could be employed to control the reservoir [22]. Due to the possibility of using a gated spillway, some discussion of reservoir evacuation and first filling is included in this chapter; however, for a more detailed discussion, refer to Chapter 4, “General Outlet Works Design

Considerations,” in this design standard and ACER Technical Memorandum No. 3, *Criteria and Guidelines for Evacuating Storage Reservoirs and Sizing Low-Level Outlet Works* [22]. Please note that a reservoir evacuation study is typically associated with an emergency situation. Generally speaking, an emergency situation could initiate rapid lowering of the reservoir to limit or prevent damage or failure of an appurtenant structure or even the dam itself.<sup>25</sup> In some cases, care must be exercised with the rate of lowering the reservoir due to potential damage or failure of an appurtenant structure (adverse hydraulics), dam embankment (slope failure), or reservoir rim (landslide).

Reservoir evacuation and first filling studies use similar steps as previously noted for flood routing. The following sections summarize key considerations for preparing reservoir evacuation and/or first filling studies.

### 3.6.3.1 Current Data

For an existing dam, the best source for current data is usually the SOP. However, data may need to be collected, created, and/or extended if current data are not available. For a new dam, data will be collected and/or developed. These data include:

- **Reservoir storage (acre-feet) versus reservoir elevation (feet)** portrayed as a curve or in tabular form.
- **Reservoir operations**, which could influence when and how hydraulic structure releases are made.
- **Discharge capacity for each appurtenant structure**, which will be involved in routing the hydrograph (see Section 3.6.1, “Discharge Capacity,” in this chapter for more details).

### 3.6.3.2 Starting RWS

For reservoir evacuation studies, as with flood routings, the starting RWS elevation is perhaps the most sensitive variable. One of the following three RWS elevations should be selected to determine reservoir evacuation requirements:

- **Top of joint use capacity.** – If a reservoir has a flood control requirement, a RWS associated with the top of joint use capacity may have been established and would be considered the maximum normal condition.

---

<sup>25</sup> As an example, in 1967 a potential internal erosion failure of Reclamation’s Fontenelle Dam (embankment) was averted by the rapid lowering (evacuation) of the reservoir.

**Design Standards No. 14: Appurtenant Structures for Dams  
(Spillways and Outlet Works)**

- **Top of active conservation capacity.** – If a reservoir does not have a flood control requirement (joint use storage or exclusive flood control), the RWS associated with the top of active conservation capacity would be considered the maximum normal condition.
- **Other RWS elevations.** – Some RWSs other than the top of joint use capacity or the top of active conservation capacity can be considered if current reservoir operations (for an existing dam) or planned reservoir operations (for a new dam) indicate that another RWS is more appropriate. Several examples include the following:
  - An existing reservoir has never filled over an extended period of time. In this case, the historical maximum RWS or higher may be an appropriate starting RWS. Since seepage, which might lead to internal erosion, may not be observed until first filling occurs (i.e., exceeding historical maximum RWS), there may be an elevated risk of failure potential as the reservoir reaches and exceeds the historical maximum RWS. It is at this time that reservoir evacuation capabilities will be critical.
  - For an existing or new dam that is intended to store most of a flood event with limited or no releases during the flood event, the RWS associated with part or all of the exclusive flood control or flood surcharge may be an appropriate starting RWS.

For first filling studies, the starting RWS will vary depending on the site-specific conditions. Some of the considerations will include:

- **Existing dams.** – First filling conditions will exist for RWSs that exceed the maximum historical RWS. Filling rates will be unique for a given dam and may vary from lower to upper reservoir elevation ranges. A normal or common rate might be 1 foot per day, with ranges of less than 1 foot to 3 feet per day for embankment dams. A normal or common rate of 10 feet per day is not excessive for concrete dams on competent rock foundations. Also, intermediate “holds” on (stoppage of) reservoir filling may be incorporated into the first filling requirements. These “holds” provide time windows to monitor dam conditions and, if needed, revise filling rates. Refer to Chapter 4, “General Outlet Works Design Considerations,” in this design standard for more details.
- **New and modified dams.** – First filling conditions will be established prior to completing construction. As noted for existing dams, filling rates will be unique for a given dam and may vary from lower to upper reservoir elevation ranges. A normal or common rate might be 1 foot per day, with ranges of less than 1 foot to 3 feet per day for embankment



dams. A normal or common rate of 10 feet per day is not excessive for concrete dams on competent rock foundations. Also, intermediate “holds” on (stoppage of) reservoir filling may be incorporated into the first filling requirements. These “holds” provide time windows to monitor dam conditions and, if needed, revise filling rates. Refer to Chapter 4, “General Outlet Works Design Considerations,” in this design standard more details.

### 3.6.3.3 Hydrology

Reservoir inflows for the period of evacuation or first filling are based on streamflow records for the reservoir (existing) or for a given dam site (new).

- **Reservoir evacuation.** – The inflow will be the largest consecutive mean monthly streamflows for the reservoir evacuation period.
- **First filling.** – The inflow will be the combination of base flow (mean monthly streamflows for the anticipated filling period) and a frequency flood. The frequency flood will be selected so that total risks during first filling are at acceptable levels. The process for selecting the frequency flood for first filling is very similar to the process for selecting construction diversion floods. For more information, refer to Chapter 2, “Hydrologic Considerations,” in this design standard. If there are no risk considerations, the minimum frequency flood can be based on five times the length of the filling period with a minimum return period of 5 years.

For some dams such as off-stream facilities, inflow is partially or totally provided by artificial means, such as from canals, pipelines and/or pump storage. Artificial inflow should be controlled or eliminated during reservoir evacuation and first filling activities.

## 3.6.4 Other Hydraulics

The previous sections are focused on the control structure of a spillway. To further define, evaluate, and design spillways in terms of the conveyance feature and terminal structure, additional hydraulic considerations come into play.

### 3.6.4.1 Conveyance Feature

Conveyance features located immediately upstream and downstream of a control structure include approach channels, inlet structures, chutes, conduits, and/or tunnels. These conveyance features pass flow from the reservoir to the control structure, as well as pass flow from the control structure to the terminal structure. The conveyance feature (such as an approach channel and/or the inlet structure) located immediately upstream of the control structure generally has a different level of concern in terms of significant loading conditions that could lead to damage or failure of this feature resulting in an uncontrolled release of the

## **Design Standards No. 14: Appurtenant Structures for Dams (Spillways and Outlet Works)**

reservoir. However, it should be noted that (hydraulic) head losses associated with the approach channel and/or the inlet structure should be accounted for in the computation of the discharge capacity of a spillway.

It is also important that the approach channel configuration not be vulnerable to stability issues (such as slope failure during saturated conditions) so that head losses through the approach channel will not increase during flood operations. The conveyance feature (such as a chute, conduit, or tunnel) located immediately downstream of the control structure is more likely to be subject to significant loading conditions (such as large flows and high velocities) that could potentially lead to damage or failure of this feature, erosion of the foundation, and uncontrolled release of the reservoir. Therefore, the focus of the following text is on the downstream conveyance feature. There are a number of hydraulic considerations that should be evaluated as described in the following sections, which may apply to conveyance features. These hydraulic considerations include:

- **Cavitation potential**, see Section 3.6.4.1.1 in this chapter.
- **Freeboard for conveyance features**, see Section 3.6.4.1.2 in this chapter.
- **Converging and diverging chute walls**, see Section 3.6.4.1.3 in this chapter.
- **Vertical curvature, horizontal curvature, and superelevation**, see Section 3.6.4.1.4 in this chapter.
- **Stagnation pressure**, see Section 3.6.4.1.5 in this chapter.

### **3.6.4.1.1 Cavitation Potential**

Damage and/or failure of conveyance features can and has resulted from cavitation<sup>26</sup> (see figures 3.6.4.1.1-1 and 3.6.4.1.1-2). Some case studies of damage occurring due to cavitation include Glen Canyon Dam service spillways, Hoover Dam service spillways, and Yellowtail Dam service spillway. Because of Reclamation's past experiences, considerable research and development have been undertaken to the point that most hydraulic analyses and designs of spillways will include evaluation of cavitation potential and subsequent mitigation, if needed. Evaluation of cavitation potential is based on estimating the cavitation index ( $\sigma$ ), which is a function of pressure and velocity [7, 23].

---

<sup>26</sup> Cavitation is defined as the formation of bubbles or voids in low pressure zones within a liquid (spillway releases) due to flow surface irregularities and/or changes in flow surface geometry. The bubbles or voids pass into downstream higher pressure zones, rapidly collapse and issue high pressure shock waves. If the collapsing bubbles or voids are near a flow surface, high frequency impacts occur which result in fatigue and erosion of flow surface materials [23].

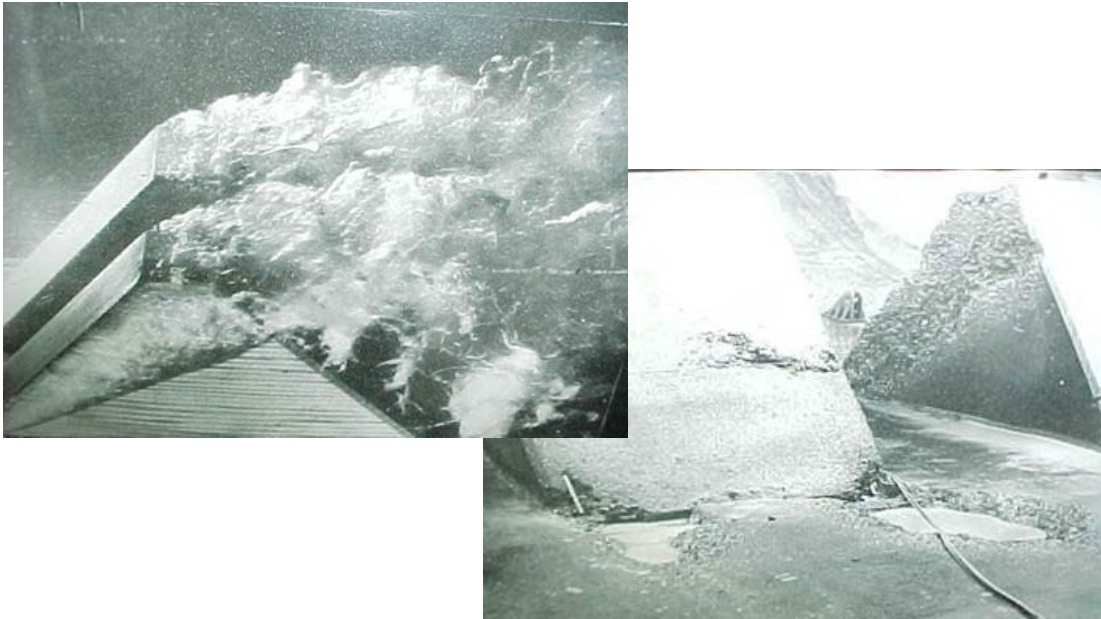
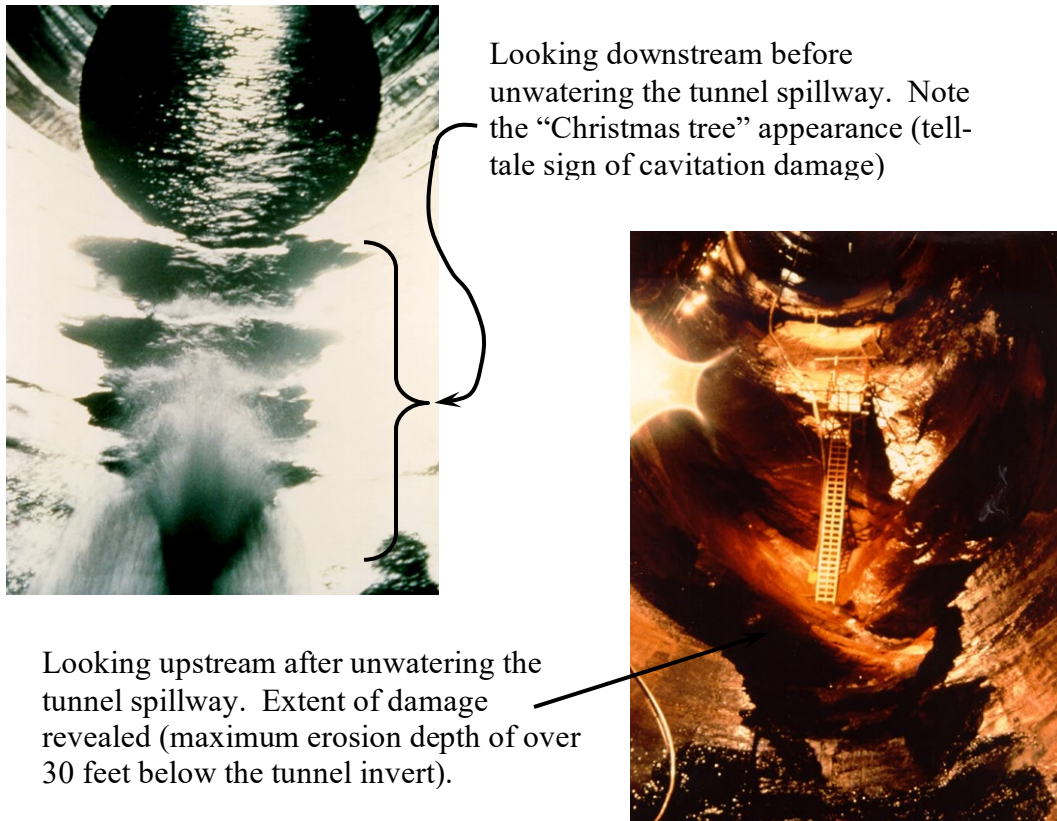


Figure 3.6.4.1.1-1. Cavitation simulation: (left) cavitation created in Reclamation’s low ambient pressure chamber: (right) cavitation damage noted after the test.



Looking downstream before unwatering the tunnel spillway. Note the “Christmas tree” appearance (tell-tale sign of cavitation damage)

Looking upstream after unwatering the tunnel spillway. Extent of damage revealed (maximum erosion depth of over 30 feet below the tunnel invert).

Figure 3.6.4.1.1-2. 1983 Spillway operations resulted in significant cavitation damage – Glen Canyon Dam, Arizona.

**Design Standards No. 14: Appurtenant Structures for Dams  
(Spillways and Outlet Works)**

$$\sigma = \frac{p - p_v}{\frac{\rho V^2}{2}} \quad (\text{cavitation index equation})$$

Where:  $\sigma$  is the cavitation index.  
 $p$  is the pressure at the flow surface (atmospheric pressure plus hydrostatic pressure (lb/ft<sup>2</sup>).  
 $p_v$  is the vapor pressure of water, which is temperature dependent (typical value is 25.65 lb/ft<sup>2</sup> at 50 °F) (lb/ft<sup>2</sup>).  
 $\rho$  is the density of water, which is temperature dependent (typical value is 62.4 lb/ft<sup>3</sup> at 50 °F) (lb/ft<sup>3</sup>)  
 $V$  is the average flow velocity (ft/s)

General relationships between the cavitation indices and flow surface tolerances or roughnesses ( $T_s$ )<sup>27</sup> are summarized in Section 3.8.5.3, “Tolerances,” in this chapter. As part of the standard step water surface profile analyses, cavitation indices profiles are estimated along the length of the conveyance feature. Details on evaluating and estimating cavitation potential are further addressed in Chapter 5, “Hydraulic Considerations for Spillways and Outlet Works,” in this design standard.

**3.6.4.1.2 Freeboard for Conveyance Features**

In this case, freeboard is defined as the difference (in feet) between the water surface and the top of the walls of the chute or crown of the conduit or tunnel. Standard step water surface profile analyses are made to determine depth of flow and average velocity along the length of the conveyance feature. Details on evaluating and estimating freeboard for conveyance features are further addressed in Chapter 5, “Hydraulic Considerations for Spillways and Outlet Works,” in this design standard. Some specific considerations include:

- **For new spillway channels or chutes.** – Reclamation typically uses an empirical relationship, which is a function of average flow velocity ( $V$ ) and depth of flow ( $d$ ) [3]. This freeboard estimate is typically associated with the design discharge, supercritical flow condition and accounts for flow surface roughness, wave action, air bulking, splash, and spray.

$$FB_C = 2 + 0.025V(d)^{\frac{1}{3}} \quad (\text{chute wall freeboard equation})$$

Where:  $FB_C$  is the minimum freeboard above the water surface (ft).  
 $V$  is the average flow velocity (ft/s).  
 $d$  is the flow depth (ft).

<sup>27</sup> Flow surface roughnesses ( $T_s$ ) are defined by an offset (isolated abrupt surface irregularities where the dimension of the irregularity perpendicular to the flow is large relative to its dimension parallel with the flow) and slope (variations caused by surface irregularities where the dimension parallel with the flow is large relative to the variation perpendicular to the flow) [23].

Please note that this estimate is appropriate for straight channels and chutes. However, if there is horizontal curvature, superelevation of the water surface may occur as the flow is conveyed around the curve. To account for this, additional freeboard may be needed. Refer to Section 3.6.4.1.4, “Vertical Curvature, Horizontal Curvature and Superelevation,” in this chapter. Finally, additional guidance about analytically evaluating air entrainment and air bulking can be found in Engineering Monograph No. 41, *Air-Water Flow in Hydraulic Structures* [24].

- **For existing spillway channels or chutes.** – Releasing more than the original design discharge may result with current (updated) hydrology. In this case, freeboard encroachment up to overtopping the conveyance feature can result, leading to adverse flow conditions and damage or progressive failure of the conveyance feature, control structure, and uncontrolled release of part of the (or the entire) reservoir<sup>28</sup> (see figure 3.6.4.1.2-1). To further evaluate this condition, air entrainment and air bulking potential should be estimated [7].
- **For existing and new spillway conduits or tunnels that are designed to remain in free-flow conditions** (i.e., not pressurized or in an unstable transition such as “slug flow,” due to air bulking, surging, etc.). – The wetted area should generally not exceed 75 percent of the total cross-sectional area of the conduit or tunnel at the downstream end during maximum discharge [3]. To ensure that 75 percent of the total cross-section area is not exceeded, all tailwater conditions (ranging from normal operations to flood conditions) should be fully evaluated. Under this limitation, air will be able to pass up the conduit or tunnel from the downstream end and prevent the formation of subatmospheric pressure. Subatmospheric pressure could lead to unstable flow conditions (such as slug flow) and/or pressurization of the conduit or tunnel. In some cases, air vent piping from the downstream end, which is hung from the conduit or tunnel crown, has been used to convey air upstream. Although this approach has been used successfully, it is not recommended if there are other options because it reduces the total cross-section area of the conduit or tunnel. Also, upstream venting of the conduit or tunnel has been and can be used to help prevent the formation of subatmospheric pressure. However, relying solely on upstream venting and allowing the wetted area to exceed 75 percent of the total downstream area of the conduit or tunnel is not advisable. Finally, care should be taken when evaluating the vertical and horizontal curvatures of the conduit or tunnel profile and alignment to ensure that sealing does not occur along some portion by surging, air bulking, or wave action.

---

<sup>28</sup> A well-documented case study of uncontrolled release of a reservoir due to spillway chute wall overtopping, subsequent erosion of the spillway foundation, and headcutting back to the reservoir was the December 1999 failure of El Guapo Dam in Venezuela [7].

**Design Standards No. 14: Appurtenant Structures for Dams  
(Spillways and Outlet Works)**



2005 spillway operation. Standing wave at downstream end of transition with cross waves downstream of standing wave – Hyrum Dam, Utah.

1999 spillway chute wall overtopping, leading to dam failure – El Guapo Dam, Venezuela (courtesy of Ing. Alejandro Hitcher).



**Figure 3.6.4.1.2-1. Freeboard.**



**3.6.4.1.3 Converging and Diverging Chute Walls**

The best hydraulic performance in a discharge channel (such as a spillway chute) is achieved when the channel walls are parallel to the direction of flow. However, economy and other factors (such as topography, type, and size of conveyance feature and terminal structure) may dictate a channel narrower or wider than either the control structure or terminal structure, which results in converging or diverging channel walls. Wall convergence must be made gradual to avoid cross waves and/or standing waves, creating wave run-up on the walls, and uneven distribution of flow across the channel (see figure 3.6.4.1.2-1). Similarly, the rate of divergence of the sidewalls must be limited, or the flow will not uniformly spread to occupy the entire width of the channel. Based on experimentation, Reclamation has developed a relationship between acceptable convergence and divergence wall angles and the Froude number [3, 7] for unpressurized (free flow) conditions.

$$\tan \alpha \leq \frac{1}{3F} \text{ (chute wall angle – convergence and divergence)}$$

Where:  $\alpha$  is the angle of convergence or divergence with respect to the spillway channel centerline (degrees).  
 $F$  is the Froude number =  $V/(gd)^{1/2}$ .  
 $V$  is the average flow velocity (ft/s) at the beginning of the transition.  
 $d$  is the depth of flow (ft) at the beginning of the transitions.  
 $g$  is the acceleration due to gravity (ft/s<sup>2</sup>).

**3.6.4.1.4 Vertical Curvature, Horizontal Curvature, and Superelevation**

Due to topography and/or geology, changes in direction of the conveyance features may be needed. These changes in direction are addressed through vertical and horizontal curves for unpressurized (free flow) conditions.

- **Vertical curvature.** – With few exceptions, vertical curvature is only used in the conveyance features downstream of the control structures (i.e., applicable to chutes, tunnels, and conduits). Both concave<sup>29</sup> and convex<sup>30</sup> curvatures have and can be used in the design of conveyance features [3].

For concave curvature, generally used for the transition between the ogee crest and the downstream chute conveyance feature or between the chute conveyance feature and a flip bucket terminal structure, simple (circular) curves can be used and an approximate relationship, which provides a minimum curvature, is defined by the following equation:

<sup>29</sup> Concave is defined as inward curvature.

<sup>30</sup> Convex is defined as outward curvature.



**Design Standards No. 14: Appurtenant Structures for Dams  
(Spillways and Outlet Works)**

$$r = \frac{2qV}{p_F} \Rightarrow r = \frac{2dV^2}{p_F} \text{ (minimum concave radius of curvature)}$$

Where:  $r$  is the minimum radius of curvature, which should not be less than  $5d$  (ft).  
 $q$  is the unit discharge (ft<sup>3</sup>/s/ft).  
 $V$  is the average velocity (ft/s).  
 $d$  is the flow depth (ft).  
 $p_F$  is the normal dynamic pressure exerted on the flow surface (an assumed value of  $p_F = 1,000$  lb/ft<sup>2</sup> will normally produce acceptable radius).

For convex curvature, generally used for the upper portion of the conveyance features, vertical (parabolic) curves should be used and should be flatter than the trajectory of a free jet to prevent separation of flow from the flow surface (refer to Section 3.6.4.2.3, "Trajectory of a Free Jet," in this chapter for more details about estimating trajectory of a free jet). The following vertical curve equation can be used to lay out the flow surface. Also, when checking the vertical curve with the free jet trajectory equation found in Section 3.6.4.2.3, "Trajectory of a Free Jet," in this chapter, use  $k = 1.5$ .

$$y = \frac{r_{slp}}{2} x^2 + G_1 x + PC \text{ (vertical or parabolic curve)}$$

Where:  $y$  is the elevation of a point on the curve (ft).  
 $x$  is the distance in stations (sta) between the point of curvature ( $PC$ ) and a point along the curve (one station = 100 ft).  
 $r_{slp}$  is the rate of change of grade (slope) per station  $(G_2 - G_1) / L_{STA}$  (/sta).  
 $G_1$  is the initial grade (%). "--" indicates downward slope.  
 $G_2$  is the final grade (%). "--" indicates downward slope.  
 $L_{STA}$  is the length in stations of the curve (horizontal distance between the beginning of the curve or  $PC$ , and the end of the curve or point of tangency [ $PT$ ]) (sta).  
 $PC$  is the elevation at the beginning of the curve or point of curvature,  $PC$  (ft).

To clarify the vertical curve equation, see figure 3.6.4.1.4-1. Also, the procedure for sizing a vertical curve is:

1. Select upstream and downstream grades ( $G_1$  and  $G_2$ ).
2. Select a length for the vertical curve ( $L_{STA}$ ).
3. Compute the  $PC$  and points along the curve.
4. Compute the water (free) jet trajectory as a check, using  $k = 1.5$ .
5. If vertical curve is flatter than trajectory, curve can be shortened and re-estimated.
6. If trajectory is flatter than the vertical curve, lengthen the curve and re-estimate.

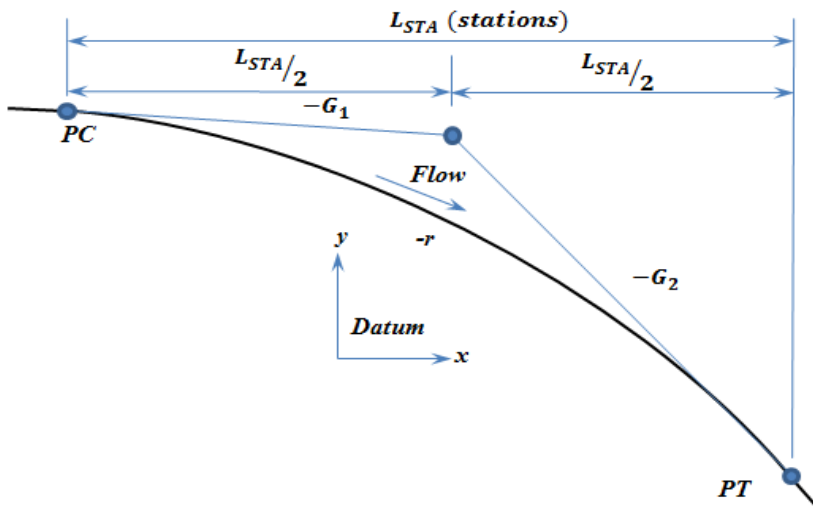


Figure 3.6.4.1.4-1. Parabolic vertical curve illustration.

**Design Standards No. 14: Appurtenant Structures for Dams  
(Spillways and Outlet Works)**

- **Horizontal curvature.** – Based on details concerning horizontal curvature in channels found in the U.S. Army Corps of Engineers’ *Hydraulic Design of Flood Control Channels*, Engineering Manual (EM) 1110-2-1601 [25], the following guidance is provided to the reader. As previously noted, the best hydraulic performance in a discharge channel (such as a spillway chute) is achieved when the channel walls are parallel to the direction of flow. However, in some cases, horizontally curved channels are employed to better adapt to the topography, and/or geology. In this case, the curved spillway chute causes the water surface to rise on the outside wall and lowering on the inside wall, which is due to centrifugal force. This condition is called “superelevation” (see next bullet for more details about superelevation) [7]. Horizontal curvature can be used in the conveyance features that are upstream and downstream of the control structures.

Conveyance features upstream of control structures (such as approach channels and inlet structures) are typically associated with subcritical flows (i.e., Froude number is less than 1.0). For this condition, the horizontal curvature at the centerline of the channel or structure should be at least 3 times the channel or structure width and can be defined by a simple (circular) curve.

Conveyance features downstream of control structures (such as chutes, tunnels, and conduits) are typically associated with supercritical flows (i.e., Froude number is greater than 1.0). For this condition, adverse hydraulics in the form of cross waves and standing waves can result, which could lead to elevated water surfaces and unsymmetrical flow conditions. To minimize adverse hydraulics, spiral transition curves in combination with simple (circular) curves should be used.

For an unbanked flow surface, the spiral transitions upstream and downstream of a simple curve can be estimated by the following equation:

$$L_s = \frac{1.82VT}{\sqrt{gd}} \text{ (upstream and downstream spiral length for unbanked curve)}$$

Where:  $L_s$  is the minimum length of the upstream and downstream spirals for unbanked curves (ft).  
 $V$  is the average velocity (ft/s).  
 $T$  is the conveyance feature width at the water surface (ft).  
 $g$  is the acceleration due to gravity (ft/s<sup>2</sup>).  
 $d$  is the flow depth (ft).

For a banked flow surface, the spiral transitions upstream and downstream of a simple curve can be estimated by the following equation:

$$L_s = 30\Delta y \text{ (upstream and downstream spiral length for banked curve)}$$

Where:  $L_s$  is the minimum length of the upstream and downstream spirals for banked curves (ft).  
 $\Delta y$  is the total rise in water surface on outside wall(ft).  
See following bullet (Superelevation) for more details.

For an unbanked or banked flow surface, the simple curve in combination with the spiral transitions upstream and downstream of the simple curve should not be less than the estimate provided by the following equation:

$$r_{\min} = \frac{4V^2T}{gd} \text{ (minimum radius of simple curve)}$$

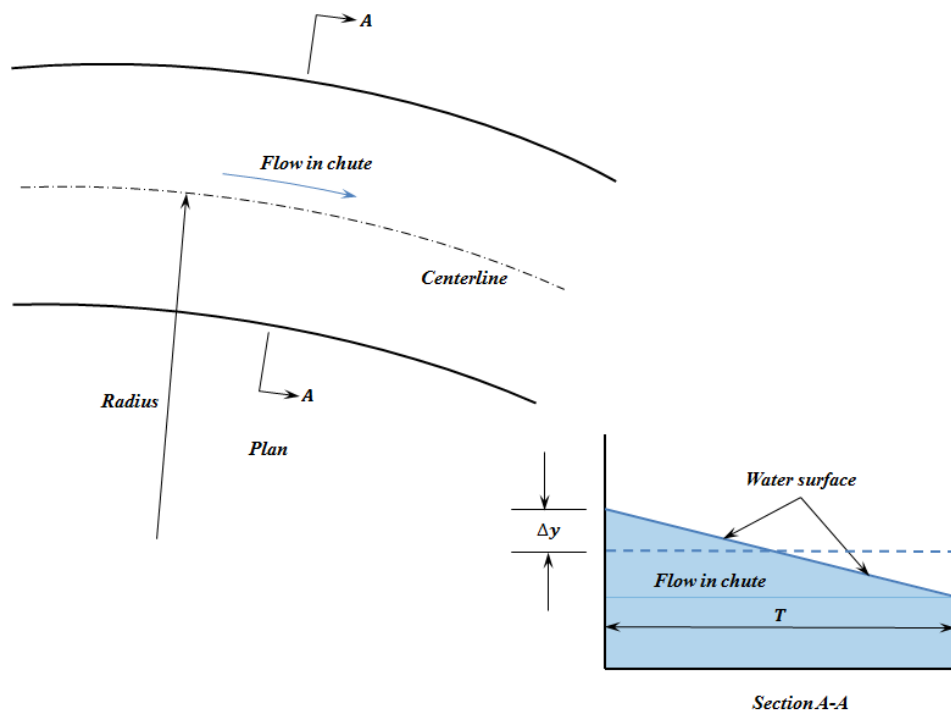
Where:  $r_{\min}$  is the minimum radius of the simple curve around the centerline of the channel or structure (ft).  
 $V$  is the average velocity (ft/s).  
 $T$  is the conveyance feature width at the water surface (ft).  
 $g$  is the acceleration due to gravity (ft/s<sup>2</sup>).  
 $d$  is the flow depth (ft).

- **Superelevation.** – Based on details concerning superelevation in channels found in the U.S. Army Corps of Engineers' *Hydraulic Design of Flood Control Channels*, EM 1110-2-1601 [25], the following equation can be used to approximate the total rise in the water surface for both unbanked and banked flow surfaces along horizontal curvature (see figure 3.6.4.1.4-2) [7, 25]:

$$\Delta y = \frac{C_{SE}V^2T}{gr} \text{ (total rise in water surface)}$$

**Design Standards No. 14: Appurtenant Structures for Dams  
(Spillways and Outlet Works)**

Where:  $\Delta y$  is the total rise in water surface on the outside wall (ft).  
 $C_{SE}$  is a coefficient ranging from 0.5 for all subcritical flow and for chutes with spiral transitions or spiral banks to 1.0 for trapezoidal channels subject to supercritical flow and for rectangular channels with circular curves subject to supercritical flow.  
 $V$  is the average flow velocity (ft/s).  
 $T$  is the channel width at elevation of centerline of water surface (ft).  
 $g$  is acceleration due to gravity (ft/s<sup>2</sup>).  
 $r$  is radius of channel centerline curvature (ft).



**Figure 3.6.4.1.4-2. Superlevation illustration.**

Please note that when dealing with horizontal curvature associated with conveyance features, the total freeboard should include the superlevation estimate ( $\Delta y$ ) and the value estimated in Section 3.6.4.1.2, “Freeboard for Conveyance Features,” in this chapter.

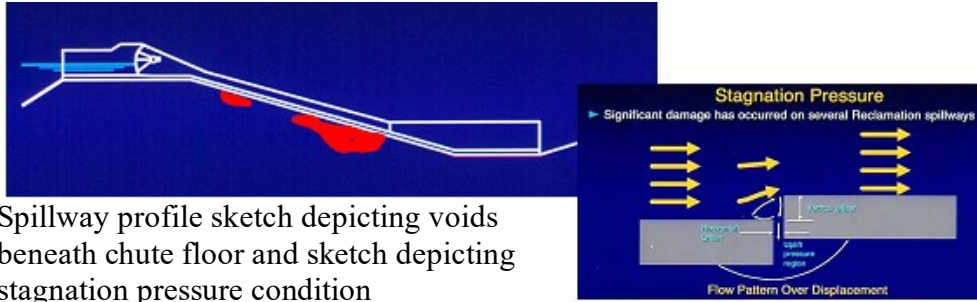
### 3.6.4.1.5 Stagnation Pressure

Damage and/or failure of conveyance features have and can result from stagnation pressure,<sup>31</sup> sometimes referred to as “hydraulic jacking” (see figure 3.6.4.1.5-1). Some case studies include Big Sandy Dam service spillway and Dickinson Dam service spillway. Because of Reclamation’s past experiences, considerable research and development have been undertaken to the point that most hydraulic analyses, and designs of spillways will include evaluation of stagnation pressure potential and subsequent mitigation, if needed [7, 26]. Assessment of stagnation pressure potential is based on inspection of flow surfaces for existing spillways, evaluation of floor joint details and floor cracking for both existing and new spillways, and estimating uplift pressures (beneath the flow surface) based on average flow velocities, joint opening, and/or crack size. As part of the standard step water surface profile analyses, average velocity profiles are used to estimate uplift profiles along the length of the conveyance feature. Details on evaluating and estimating stagnation pressure potential are further addressed in Chapter 5, “Hydraulic Considerations for Spillways and Outlet Works, in this design standard.”

---

<sup>31</sup> Stagnation pressure refers to two conditions that can result in damage and/or failure of the spillway: (1) High velocity, high pressure flows enter cracks or open joints in the spillway flow surface (such as a chute), which results in uplift pressure that lifts (displaces) portions of the spillway conveyance feature; and (2) High velocity, high pressure flows enter the foundation through cracks or open joints in the spillway flow surface, which results in internal erosion of the foundation and loss of support of portions of the spillway conveyance feature [26].

**Design Standards No. 14: Appurtenant Structures for Dams  
(Spillways and Outlet Works)**



Spillway profile sketch depicting voids beneath chute floor and sketch depicting stagnation pressure condition



Dickinson Dam, North Dakota - 1954 spillway chute stagnation pressure failure, exacerbated by frozen foundation/drainage system



Big Sandy Dam, Wyoming - 1983 spillway chute stagnation pressure failure, exacerbated by excessive seepage and frost damage



Reclamation Dam – Void below spillway chute floor; ground penetrating radar (GPR) identifying voids; and spillway chute foundation and floor replacement to mitigate foundation piping and high potential of stagnation pressure failure

**Figure 3.6.4.1.5-1. Stagnation pressure (hydraulic jacking).**

### 3.6.4.2 Terminal Structure

Terminal structures located immediately downstream of the conveyance feature include stilling basins, energy dissipaters, and flip buckets (see figure 3.6.4.2-1). These structures are intended to dissipate or manage the kinetic energy of the flow, so it can be returned to the river or stream without significant scour or erosion that could damage or fail the dam and appurtenant structures [3]. For sizing of symmetrical, typical terminal structures, procedures found in Engineering Monograph No. 25, *Hydraulic Design of Stilling Basins and Energy Dissipaters* [27], and Research Report No. 24, *Hydraulic Design of Stilling Basins for Pipe or Channel Outlets* [28] are used. These procedures are based on Reclamation's designs of hundreds of terminal structures. For unsymmetrical, atypical terminal structures and/or for releases outside the ranges noted in these references, other design and analysis approaches are used including finite volume analysis, commonly referred to as computational fluid dynamics (CDF) and physical modeling. Details of hydraulically evaluating, analyzing, and designing terminal structures are further addressed in Chapter 5, "Hydraulic Considerations for Spillways and Outlet Works," in this design standard.

There are a number of hydraulic considerations associated with terminal structures that are highlighted in the following sections. These hydraulic considerations include:

- **Freeboard for terminal structures**, see Section 3.6.4.2.1 in this chapter.
- **Minimum radius of curvature**, see Section 3.6.4.2.2 in this chapter.
- **Trajectory of a free jet**, see Section 3.6.4.2.3 in this chapter.

#### 3.6.4.2.1 Freeboard for Terminal Structures

For terminal structures such as stilling basins, the freeboard is defined as the difference (in feet) between the water surface and the top of the walls. The most common terminal structure employed by Reclamation is the hydraulic jump stilling basin. For this terminal structure, the standard step water surface profile analyses are done to determine initial flow depths ( $d_1$ ) and average velocity ( $V_1$ ) before the hydraulic jump (entering the stilling basin). Then, the force-momentum relationship is used to determine the flow depth or conjugate depth ( $d_2$ ) after the hydraulic jump (exiting the stilling basin) [3]. This relationship is expressed by the following equation and applies to all hydraulic jump terminal structures with horizontal floors (for sloping floor or apron hydraulic jump terminal structure, see Chapter 5, "Hydraulic Considerations for Spillways and Outlet Works," in this design standard):

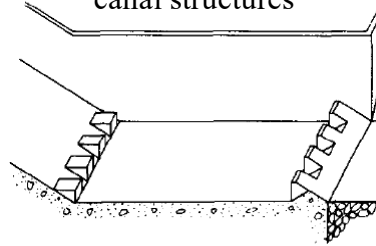


**Design Standards No. 14: Appurtenant Structures for Dams  
(Spillways and Outlet Works)**

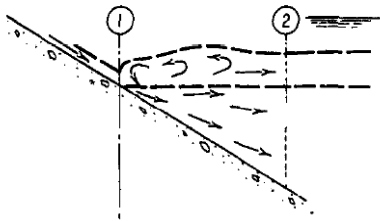
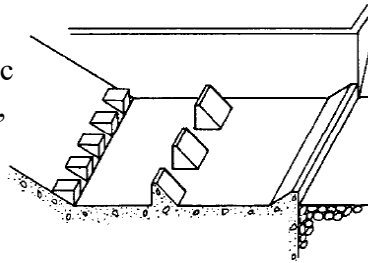


Type I – Hydraulic jump, horizontal apron

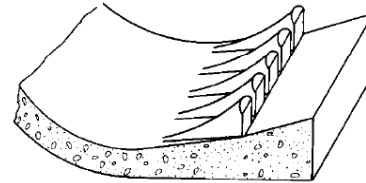
Type II – Hydraulic jump for high dam spillways and large canal structures



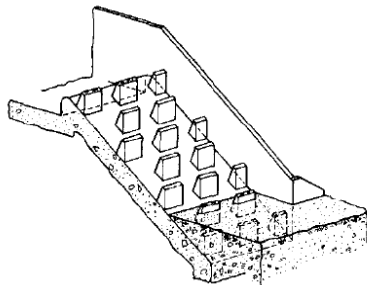
Type III – Short hydraulic jump for canal structures, small outlet works, and small spillways



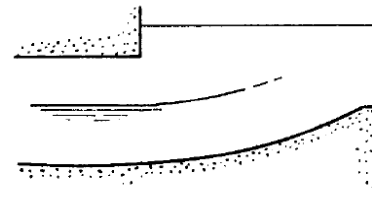
Type V – Hydraulic jump, sloping apron



Type VII – Slotted and solid flip buckets for high, medium, and low dam spillways



Type IX – Baffled apron for canal or spillway drops



Type X – Improved flip bucket for tunnel spillways

**Figure 3.6.4.2-1. Terminal structures.**

$$\frac{d_2}{d_1} = \frac{\sqrt{1+8F^2} - 1}{2}$$

Where:  $d_2$  is the conjugate depth or depth at the downstream end of the hydraulic jump (ft).  
 $d_1$  is the depth of flow entering the stilling basin (ft).  
 $F$  is the Froude number entering the stilling basin =  $V_1/(gd_1)^{1/2}$ .  
 $V_1$  is the average velocity entering the stilling basin (ft/s).

The following empirical expression has proven to provide acceptable freeboard estimates for most situations:

$$FB_T = 0.1(V_1 + d_2) \text{ (terminal structure wall freeboard equation) [3]}$$

Where:  $FB_T$  is the minimum freeboard above the water surface (ft).  
 $V_1$  is the average velocity entering the stilling basin (ft/s).  
 $d_2$  is the conjugate depth or depth at the downstream end of the hydraulic jump (ft).

#### 3.6.4.2.2 Minimum Radius of Curvature

For some terminal structures such as a flip bucket, concave curvature of the flow surface is used to establish a trajectory of the discharge to a point downstream where the kinetic energy can be safely dissipated. As previously discussed in Section 3.6.4.1.4, “Vertical Curvature, Horizontal Curvature, and Superelevation,” in this chapter, an approximate relationship that establishes a minimum radius for concave curvature is defined by the following equations:

$$r = \frac{2qV}{p_F} \Rightarrow r = \frac{2dV^2}{p_F}$$

Where:  $r$  is the minimum radius of curvature, which should not be less than  $5d$  (ft).  
 $q$  is the unit discharge ( $\text{ft}^3/\text{s}/\text{ft}$ ).  
 $V$  is the average velocity (ft/s).  
 $d$  is the flow depth (ft).  
 $p_F$  is the normal dynamic pressure exerted on the flow surface (an assumed value of  $p = 1,000 \text{ lb}/\text{ft}^2$  will normally produce acceptable radius).

#### 3.6.4.2.3 Trajectory of a Free Jet

For some terminal structures such as a flip bucket or overtopping a concrete dam (both overflow and non-overflow sections), it is important to estimate the trajectory of discharge to determine the downstream impingement area (such as a plunge pool) which must be capable of dissipating much of the kinetic energy. It

**Design Standards No. 14: Appurtenant Structures for Dams  
(Spillways and Outlet Works)**

has been determined that the trajectory equation noted in *Design of Small Dams*, 3<sup>rd</sup> Edition, Chapter 9, “Spillways,” equations 19 and 23 overestimate the trajectory (i.e., estimate a flatter path) [3]. In lieu of using these equations, the following equation should be used to estimate the free jet trajectory [29]. Also, for clarification refer to figure 3.6.4.2.3-1:

$$y = x \tan \theta_0 - \frac{x^2}{4kh_v \cos^2 \theta_0}$$

Note, if the brink is horizontal (i.e.,  $\theta_0 = 0$  degrees), the previous equation reduces to:

$$y = -\frac{x^2}{4kh_v} = -\frac{x^2}{2V_b^2}$$

Where:

- $k$  is the trajectory coefficient used to alter the undernappe shape (flatter or steeper than unsupported free jet). When  $k=1.0$ , undernappe follows a free jet trajectory and when  $k>1.0$ , undernappe is flatter than free jet trajectory.
- $h_v = h_{vb}$  is velocity head at brink of jet springing free from flip bucket or dam crest (ft) =  $V_b^2/2g$ .
- $V_b$  is brink velocity (ft/s) for the flip bucket. For concrete dam overtopping,  $V_b = 1.399V_c = 0.808(2gH)^{0.5}$
- $V_c$  is critical velocity (ft/s) =  $Q/(L y_c)$ .
- $d_c$  is the critical depth occurring upstream of brink where jet springs free from dam (ft) =  $0.67H$ .
- $H$  is total head or overtopping depth of dam (ft).
- $L$  is crest length (ft).
- $Q$  is total discharge (ft<sup>3</sup>/s).
- $\theta_0$  is initial angle of the jet from horizontal at the brink of jet springing free from the flip bucket or dam crest (degrees).

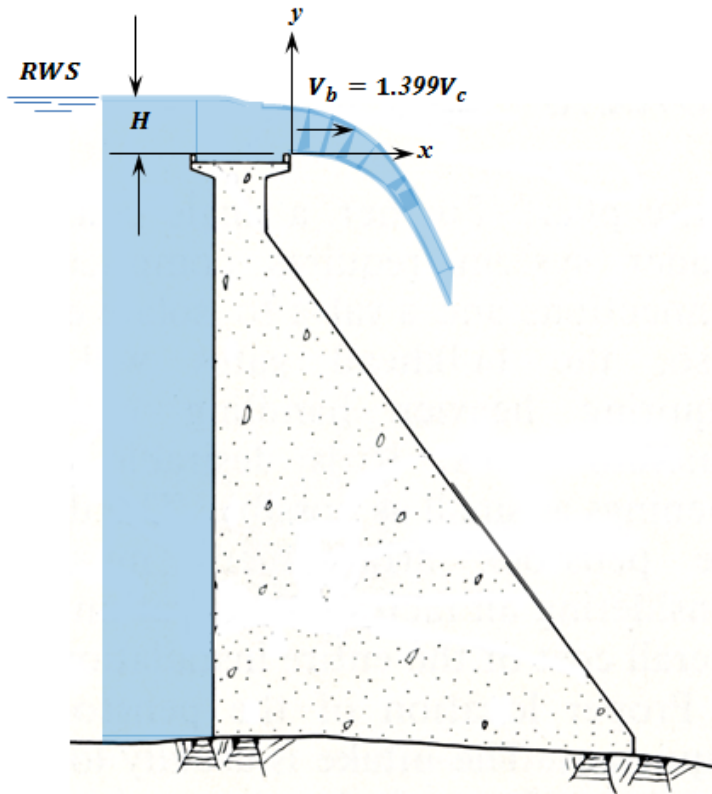


Figure 3.6.4.2.3-1. Trajectory of a free jet illustration.

### 3.6.4.3 Erosion Protection

Erosion protection is a key consideration when evaluating existing spillways and designing new spillways. Primary applications of erosion protection include: armoring upstream spillway approach channels and downstream spillway exit channels, armoring plunge pool terminal structures, and overtopping protection of both concrete and embankment dams. For more information about erosion and overtopping protection, refer to Chapter 9, “Erosion of Rock and Soil,” of the *Dam Safety Risk Analysis Best Practices Training Manual* [7] and *Technical Manual: Overtopping Protection for Dams* [9], respectively. The following text focuses on spillway channel protection.

- **Estimating erosion potential.** – The initial step in determining if erosion protection is needed involves evaluating erosion potential of the soil or rock channel materials.

**Design Standards No. 14: Appurtenant Structures for Dams  
(Spillways and Outlet Works)**

- **For soil channel materials**, erosion potential can be initially assessed using procedures found in Reclamation’s *Computing Degradation and Local Scour – Technical Guideline for Bureau of Reclamation* [30]. The recommended approach uses a number of empirical equations based on experimental and prototype studies. For a more detailed erosion potential evaluation, the SITES method<sup>32</sup> is used, which was developed by the U.S. Department of Agriculture.

For a preliminary assessment of soil erosion due to a plunging water jet (i.e., estimating plunge pool erosion potential associated with a flip bucket terminal structure), a number of empirical relationships follow.

$$Y_S = 1.90H^{0.225}q^{0.54} \cos \alpha_s \text{ (Yildiz and Unzucek equation) [7, 31]}$$

Where:  $Y_S$  is the depth of erosion below tailwater (meters [m]).  
 $H$  is the elevation difference between the reservoir and tailwater surface (m).  
 $q$  is the unit discharge (cubic meters per second per meter [m<sup>3</sup>/s/m]).  
 $\alpha_s$  is water jet impingement angle with the tailwater from vertical (degrees).

$$Y_S = \frac{K_S(q^X H^Y h_s^{0.15})}{g^{0.3} d_s^{0.1}} \text{ (Mason and Arumugan equation) [7, 32]}$$

Where:  $Y_S$  is the depth of erosion below tailwater (m).  
 $H$  is the elevation difference between the reservoir and tailwater surface (m).  
 $q$  is the unit discharge (m<sup>3</sup>/s/m).  
 $h_s$  is the tailwater depth above original ground surface (m).  
 $K_S$  is equal to  $6.42-3.1H^{0.10}$ .  
 $g$  is the acceleration due to gravity (meters per second squared [m/s<sup>2</sup>]).  
 $d_s$  is the median grain size ( $D_{50}$ ) (m).  
 $X$  is equal to  $0.6-H/300$ .  
 $Y$  is equal to  $0.15+H/200$ .

<sup>32</sup> SITES method (<http://www.nrcs.usda.gov/technical/Eng/sites.html>) is based on observed behavior of soil and grass-lined spillways.

- **For rock and soil channel materials**, erosion potential can be initially assessed by comparing erodibility index<sup>33</sup> to stream power<sup>34</sup> (see figure 3.6.4.3-1). Rock erosion is governed primarily by the spacing and orientation of the discontinuities, with the properties of the intact rock being less important, except in very soft material. The concept of rock mass index correlated with power, and how it relates to removing rock by flowing water, is expressed as the erodibility index. The erodibility index has been further correlated empirically to the erosive power of flowing water, which is termed “stream power.” This correlation represents an evaluation of original data used to develop the stream power-erodibility index relationship based on logistic regression [33]. The governing equations for the stream power-erodibility index method are noted below.

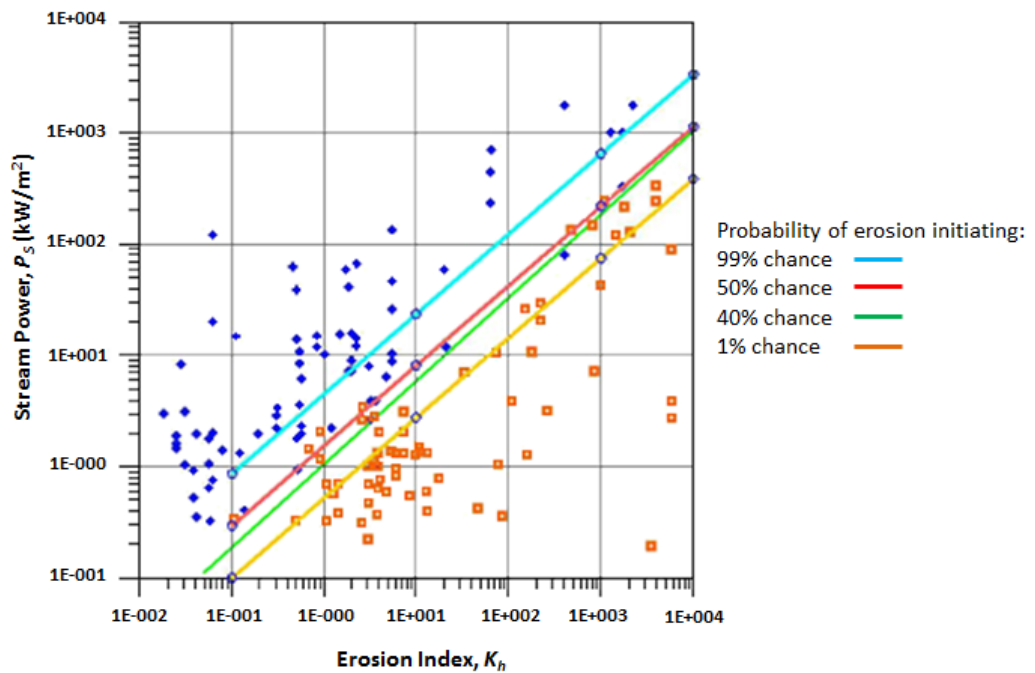


Figure 3.6.4.3-1. Erosion potential – erodibility index versus stream power [33].

<sup>33</sup> Erodibility index is the rock or soil mass properties index which characterizes the potential removal due to flowing water. The erodibility index is a function of mass (intact) strength of the rock or soil, mean block size of the rock or soil, interblock friction resistance, and the orientation of the rock or soil feature relative to the flowing water.

<sup>34</sup> Stream power is the rate of energy (power) dissipation, which is a function of flow depth, flow velocity, and the energy grade line.

**Design Standards No. 14: Appurtenant Structures for Dams  
(Spillways and Outlet Works)**

$$K_h = M_s K_b K_d J_s \text{ (erodibility index equation)}$$

Where:  $K_h$  is the erodibility index.  
 $M_s$  is the mass strength for the rock (i.e., uniaxial compressive strength) – (megapascals [MPa]).  
 $K_b$  is the particle or fragment size that forms the mass (based on joint spacing or rock mass classification parameters) equal to  $RQD/J_n$ .  
 $K_d$  is the interblock strength equal to  $J_r/J_a$ , which is based on Barton's Q-system.<sup>35</sup>  $J_r$  is the joint roughness number and  $J_a$  is the joint alteration number.  
 $J_s$  is a factor that accounts for the relative shape and orientation of the rock blocks.<sup>36</sup>  
 $J_n$  is a modified joint set number.<sup>37</sup>  
 $RQD$  is the rock quality designation which is determined by measuring the core recovery percentage of core chunks that is greater than 100 millimeters in length, ranging from less than 25 percent (very poor) to 90-100 percent (excellent).

$$P_S = \gamma_w V d S \text{ (stream power equation for surface flow), and}$$

$$P_S = \frac{\gamma_w Q Z}{A} \text{ (stream power equation for free fall jet)}$$

Where:  $P_S$  is the rate of energy (power) dissipation (kilowatts per square meter [kW/m<sup>2</sup>]).  
 $\gamma_w$  is unit weight of water – (kilonewton per cubic meter [kN/m<sup>3</sup>]).  
 $V$  is the average velocity of flow (meters per second [m/s]).  
 $d$  is the depth of flow (m).  
 $S$  is the slope of the energy grade line.  
 $Q$  is the total discharge at the location being examined (cubic meters per second [m<sup>3</sup>/s])  
 $Z$  is the head or height which the free jet falls (m).  
 $A$  is the area of the jet as it impacts the rock or soil surface (square meters [m<sup>2</sup>]).

<sup>35</sup> Refer to Chapter 9, "Erosion of Rock and Soils," of the *Dam Safety Risk Analysis Best Practices Training Manual* [7] for suggested values.

<sup>36</sup> Ibid.

<sup>37</sup> Ibid.

Once erodibility indices ( $K_h$ ) and stream power values ( $P$ ) have been estimated, they can be compared to (plotted on) figure 3.6.4.3-1 to determine the likelihood of erosion initiation. It should be noted that likelihood of erosion initiation can be interpolated between the lines noted on figure 3.6.4.3-1.

- **Determining erosion protection requirements.** – Erosion channel protection can include vegetative cover (grass), riprap, grouted riprap, gabions, RCC, soil cement, and precast concrete blocks. For more information about vegetative cover (grass), gabions, RCC, soil cement, and precast concrete blocks, refer to the *Technical Manual: Overtopping Protection for Dams* [9]. By far, the most common spillway channel protection used by Reclamation has been riprap armorment. Design of riprap armorment includes determining the median rock size or  $D_{50}$  (i.e., 50 percent of rock is smaller than  $D_{50}$ ), thickness of riprap layer, gradation of riprap and bedding layer (if needed), and edge treatment [34]. Additional information can be found in Chapter 5, “Hydraulic Considerations for Spillways and Outlet Works,” in this design standard.

### 3.7 General Foundation Considerations

This section provides general foundation considerations for determining the type, location, and size of a modified or new spillway. Detailed foundation analysis and design can be found in Chapter 6, “Structural Considerations for Spillways and Outlet Works,” of Design Standards No. 14.

As previously noted, unless highlighted, this chapter is applicable to the evaluation, analysis, and design of reinforced concrete, high velocity, and high flow spillways.

#### 3.7.1 Elastic Foundation

The following discussion relates to surface spillways, which include inlet structures, control structures, chute conveyance features, and terminal structures. This section does not apply to subsurface spillway features, such as a tunnel conveyance feature. For more information about tunnel foundation considerations, refer to Chapter 3, “Tunnels, Shafts, and Caverns,” in Design Standards No. 3.

Although it is highly recommended that a competent rock foundation be located and prepared for a spillway, a soil foundation can be acceptable if appropriate design and construction methods are employed. Due to the range of foundation types (rock and/or soil), designs for spillways include determining the base pressure for an elastic foundation. General assumptions include:



## Design Standards No. 14: Appurtenant Structures for Dams (Spillways and Outlet Works)

- The foundation is elastic (i.e., settlement at any point is proportional to the pressure at that point).
- Analyses and designs are typically based on a two-dimensional beam on an elastic foundation.
- The foundation modulus<sup>38</sup> is the elastic deformation resulting from unit pressure, or elastic uplift that results from a unit tension.

Reclamation would not consider a foundation suitable for a spillway if the foundation modulus was less than 200 pounds per square inch per inch (lb/in<sup>2</sup>/in) (elastic deformable foundation, typically associated with soft compressible soils). Suitable foundation modulus ranges have been at least 200 lb/in<sup>2</sup>/in to 2,000 lb/in<sup>2</sup>/in or greater (very rigid foundation, typically associated with firm formation or rock). A reasonable range of foundation moduli is used in a typical design. This range can be based on field and laboratory test data, technical references using field data, or assumptions based on experience and/or observations. By using a range of foundation moduli, magnitudes and locations of maximum and minimum foundation stresses (moments and shears) acting on a spillway floor slab can be determined. In general, critical locations of maximum moments and shears for a spillway floor slab include the slab-wall interfaces and the center of the slab.

While most rock foundations for a spillway can be made acceptable with some preparation, more care is needed in evaluating whether a soil foundation for a spillway can be made acceptable (see Chapter 6, “Structural Considerations for Spillways and Outlet Works,” in this design standard). The following guidelines are provided, based on the Unified Soil Classification System (USCS) [35],<sup>39</sup> and should be applied on a case-by-case basis:

- In terms of foundation compressibility, the following bullets list soils in decreasing order of acceptable foundations:
  - Soils are generally acceptable foundation materials for a spillway if they are gravel and gravelly soils (GW, GC, GP, and GM), or sands and sandy soils (SW, SC, SP, and SM).

---

<sup>38</sup> Foundation modulus is also referred to as the modulus (coefficient) of subgrade reaction.

<sup>39</sup> The USCS is a soil classification system used in engineering and geology to describe the texture and grain size of a soil. The classification system can be applied to most unconsolidated material and is represented by a two-letter symbol, where the first letter is the soil type (such as G for gravel and C for clay), and the second letter is the gradation or plasticity (such as P for poorly graded and L for low plasticity). Therefore, SW would be a well graded sand, and CH would be a clay of high plasticity.

- Soils that may be suitable foundation materials for a spillway but may require some additional evaluation, design, and foundation preparation or treatment are fine-grained soils (silts and clays) having low to medium compressibility (ML and CL).
- Soils that are unlikely to be suitable foundation materials for a spillway and would require additional evaluation, design, and foundation preparation or treatment (likely involving excavating the soil and replacing it with engineered fill, or locating a new site with better foundation materials) are fine-grained soils containing organic material and having low to medium compressibility (OL), and any fine-grained soils having high compressibility (MH, CH, OH, and PT).
- In terms of foundation permeability as it relates to internal erosion potential, the following should be considered [36]:
  - Seepage issues may exist for well to poorly graded gravels (GW, GP) and well to poorly graded sands (SW and SP), which are associated with high permeability.
  - Erodibility issues may exist for silty gravel (GM), silty sand (SM), and silts (ML) even at low gradients.

It is important to evaluate these considerations and, if needed, provide designed filters to reduce internal erosion potential. For filter design considerations, refer to Chapter 5, “Protective Filters,” in Design Standard No. 13.

### 3.7.2 Foundation Design

#### 3.7.2.1 Foundation Treatment

With the exception of including the spillway as part of a concrete dam (i.e., the foundation is the dam and there is a high level of control in terms of physical conditions and material properties), foundation treatment evaluation (of rock or soil foundation) is a very important aspect of the spillway design and considerations and is described in the following sections. These considerations include:

- **Shaping**, see Section 3.7.2.1.1 in this chapter.
- **Dental treatment**, see Section 3.7.2.1.2 in this chapter.
- **Grouting**, see Section 3.7.2.1.3 in this chapter.

**Design Standards No. 14: Appurtenant Structures for Dams  
(Spillways and Outlet Works)**

- **Cleanup**, see Section 3.7.2.1.4 in this chapter.
- **Anchors and cutoffs**, see Section 3.7.2.1.5 in this chapter.

**3.7.2.1.1 Shaping**

The foundation should be shaped so that a uniformly varying profile is obtained that is free of sharp offsets or breaks [37].

- **For soil foundations**, all organic or other unsuitable materials, such as stumps, brush, sod, and large roots should be stripped and wasted. Additionally, all pockets of soil significantly more compressible than the average foundation material should be removed and replaced with engineered fill. All irregularities, ruts, and washouts should be removed and replaced with engineered fill.
  - Unreinforced, undrained cut slopes should be flat enough to prevent sloughing. Cut slopes in soil should be determined for site-specific conditions. Many of Reclamation's excavated soil slopes have been in the range 1½:1 to 2:1 (horizontal: vertical) or flatter. It should be highlighted that much flatter cut slopes (in the range of 4:1) may be required when excavating adjacent to an embankment dam. The flatter cut slopes (referred to as transverse bonding slopes) are needed to ensure the backfill adjacent to the spillway can be effectively tied (compacted) into the existing embankment dam cut slopes.
  - Fine-grained (cohesive) soil foundations and engineered fill should be within 2 percent dry and 1 percent wet of the Proctor optimum moisture content and at least 95 percent Proctor density. Granular (cohesionless) soil foundations should be compacted to at least 94 percent compaction using the vibratory hammer method<sup>40</sup> [38].
  - Protection of a soil foundation may include leaving temporary cover of several feet of unexcavated material or placing several feet of fill material to address freezing concerns, as well as placing a 3- to 4-inch lean concrete pad or 2-inch shotcrete layer on the exposed foundation.

---

<sup>40</sup> 94 percent compaction by the vibratory hammer testing replaces 70 to 80 percent density by the relative density testing.

- **For rock foundations**, eliminate abrupt changes/breaks in the excavated profile. Also, faults or shear zones may be encountered during excavation, and the excavation of unsound rock produces depressions or shallow trenches that must be backfilled with concrete (see figure 3.7.2.1.1-1). General treatment guidelines for cavities, faults, shear zones, cracks, or seams [39] include:
  - For openings with widths 2 inches or less, clean to a depth ( $D$ ) of three times the width of the opening and treat by filling with slush grout (for more details, see Section 3.7.2.1.2, “Dental Treatment,” in this chapter).
  - For openings with widths greater than 2 inches and up to 5 feet, clean to a depth of three times the width of the opening or to a depth where the opening is 0.5 inch wide or less, but usually not to a depth exceeding 5 feet, and treat by filling with dental concrete (for more details, see Section 3.7.2.1.2, “Dental Treatment,” in this chapter).
  - Openings with widths greater than 5 feet constitute a special situation requiring the depth of cleaning and treatment to be determined in the field.

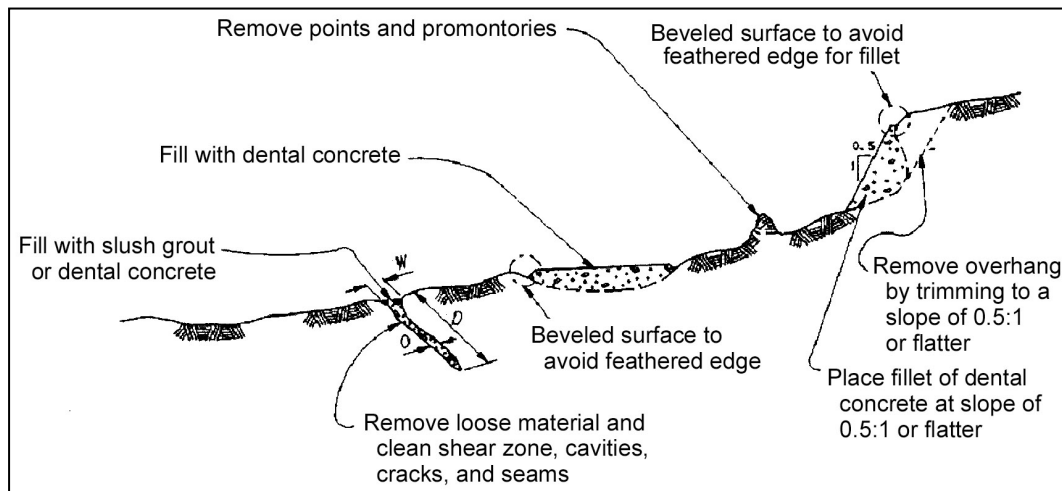


Figure 3.7.2.1.1-1. Cleaning and treatment of rock foundation [39].

If shaping requires blasting, proper procedures are essential to ensure that the permeability and strength of the rock foundation is not adversely affected. Refer to Chapter 6, “Structural Considerations for Spillways and Outlet Works,” in this design standard for blasting background and considerations.

## **Design Standards No. 14: Appurtenant Structures for Dams (Spillways and Outlet Works)**

Unreinforced, undrained cut slopes in rock may be determined on a case-by-case basis using local geologic conditions and/or reinforcement to design stable cut slopes (for reference, typically range is between ¼:1 to ½:1).

Of note, rock foundations susceptible to air or water slaking (deterioration) and/or freezing should be protected until concrete placement for the spillway begins. As with a soil foundation, protection of a rock foundation subject to slaking may include leaving temporary cover of several feet of unexcavated material or placing several feet of fill material to address freezing concerns, as well as placing a 3- to 4-inch lean concrete pad or 2-inch shotcrete layer on the exposed foundation.

### **3.7.2.1.2 Dental Treatment**

Exploratory drilling or final excavation associated with rock foundations may uncover faults, shear zones, seams, and shattered or inferior rock extending to depths that are not practical to remove [38]. These conditions require special treatment in the form of removing some of the material to depths as noted in Section 3.7.2.1.1, “Shaping,” in this chapter, and backfilling the excavation with cement grout or lean concrete. Two types of dental treatment are used:

- **Slush grout or joint mortar** is a neat cement grout (for cracks less than ½ inch) or a sand-cement slurry (for cracks greater than ½ inch) that is placed into foundation cracks. Cracks or joints are filled with grout rather than spreading grout on the surface (see figure 3.7.2.1.2-1). Slush grout should be used to fill narrow surface cracks, not to cover areas of the foundation. To ensure adequate penetration of the crack, the maximum particle size in the slush grout mixture should be not greater than one-third the crack width. The consistency of the slush grout mix may vary from a very thin mix to mortar as required to penetrate the crack. The water-cement ratio should be kept as low as possible to prevent shrinkage. Preferably, the grout should be mixed with a mechanical or centrifugal mixer, and the grout should be used within 30 minutes after mixing. The type of cement required will depend on the concentration of sulfates in the foundation materials and ground water. Low-alkali cement is required for alkali-sensitive aggregates. Sand and water quantities should be equal to that required for structural concrete. All cracks should be wetted before placing slush grout. Slush grout may be applied by brooming over surfaces containing closely spaced cracks or by troweling, pouring, rodding, or funneling into individual cracks [38].

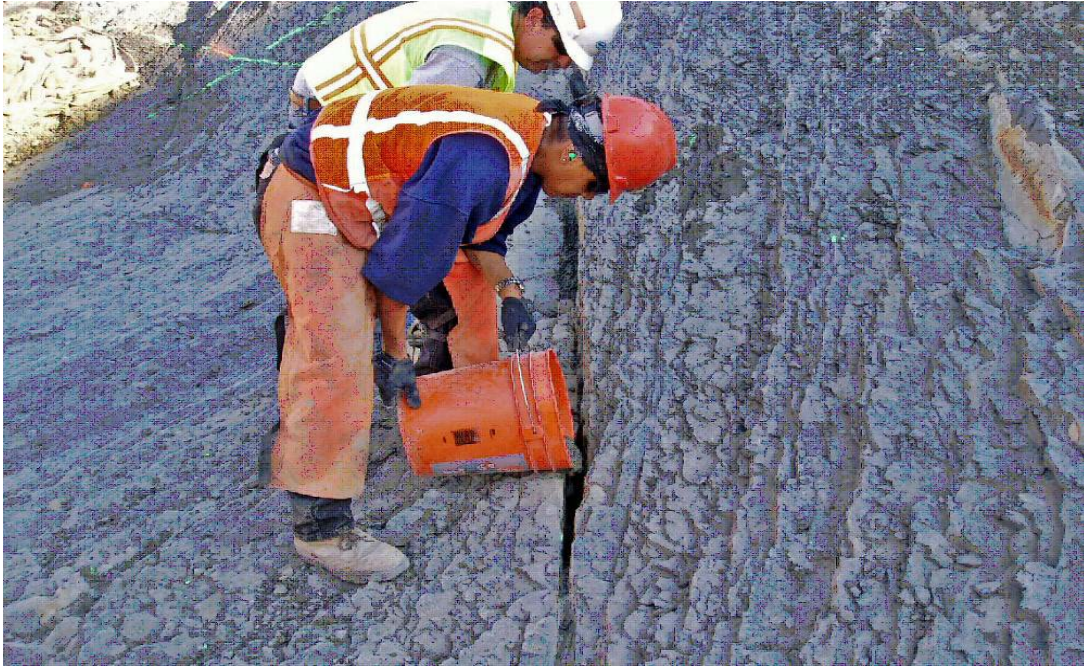
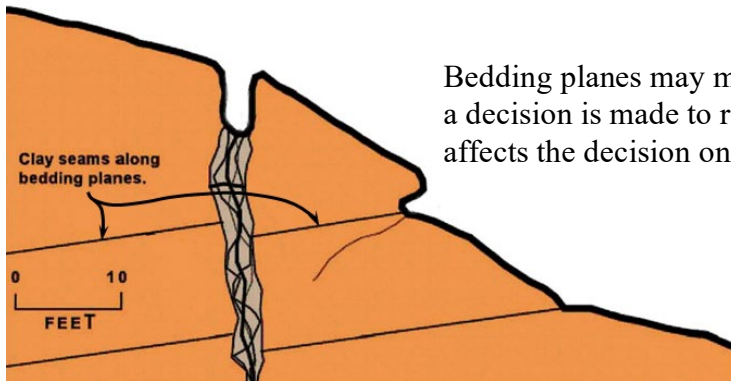


Figure 3.7.2.1.2-1. Slush grouting.

- **Dental, leveling, shaping, or backfill concrete and concrete fillets** are used to fill or shape depressions, grooves, extensive areas of vertical or near vertical surfaces, and sawteeth (deep grooves) created by bedding planes, joints, and other irregularities such as previously cleaned out solution features, shear zones, large joints, or buried channels (see figure 3.7.2.1.2-2). Formed dental concrete can be used to fillet steep slopes and fill overhangs. Placing a concrete mat over a zone of closely spaced irregularities may be appropriate in local areas. Dental concrete shaping can be used instead of removal by blasting when excessive amounts of excavation would otherwise be required. Dental concrete slabs should have minimum thicknesses of 6 inches depending on the quality of the foundation. Thin areas of dental concrete over rock projections on a jagged rock surface are likely to crack and should be avoided by using a sufficient thickness or limiting slab widths with joints. Feathering at the edges of concrete slabs shall not be permitted. To eliminate feathering, the edges of slabs shall be sloped no flatter than 45 degrees (see figure 3.7.2.1.2-3). When fillets of dental concrete are placed against vertical or near vertical surfaces, feathering on the edges shall not be permitted. Instead, a beveled surface with a minimum thickness of 6 inches will be required at the edges of the fillet (see figure 3.7.2.1.2-3). Concrete mix proportions should provide a minimum 28-day strength of 3,000 lb/in<sup>2</sup>. The maximum size aggregate should be less than one-third of the minimum thickness of slabs or one-fifth of the narrowest dimension between the side of a form and the rock surfaces.

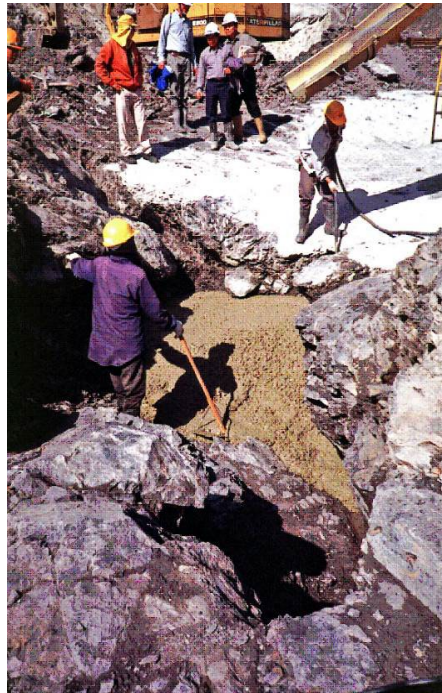
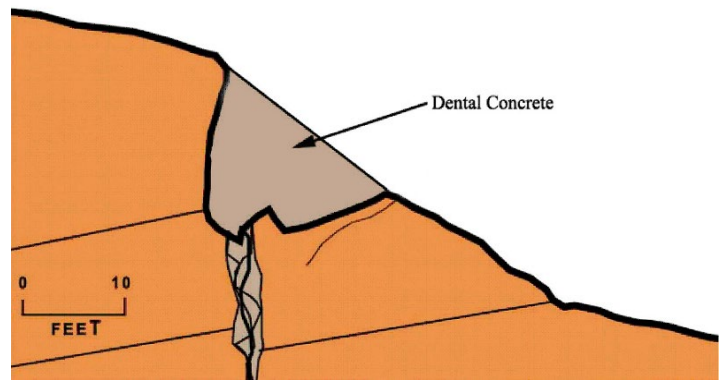


**Design Standards No. 14: Appurtenant Structures for Dams  
(Spillways and Outlet Works)**



Bedding planes may modify cleanup plans. Here, a decision is made to remove the rock mass. This affects the decision on the subsequent treatment.

Block is removed between fracture zone, bedding plane, and joints. Treatment to further shape the surface required dental concrete.



Treating foundation with dental concrete

**Figure 3.7.2.1.2-2. Dental concrete.**

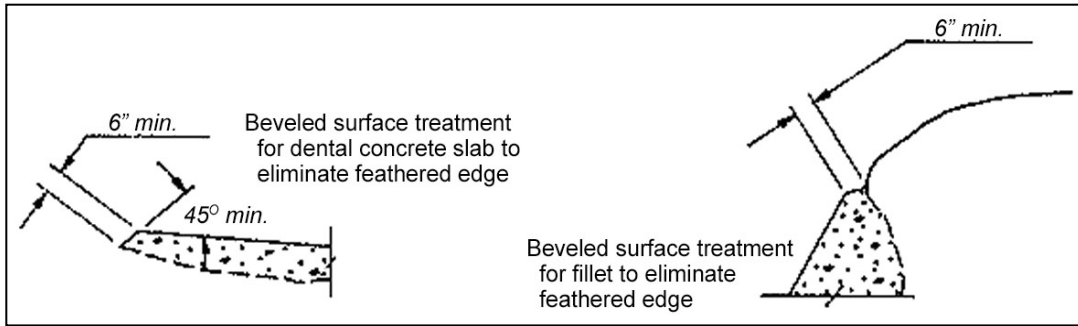


Figure 3.7.2.1.2-3. Beveled surfaces to eliminate feathered edges [39].

The cement type will depend on the concentration of sulfates in the foundation materials and ground water. Low-alkali cement is required for alkali-reactive aggregates. Aggregate and water quality should be equal to that required in structural concrete. The rock surface should be thoroughly cleaned and moistened before placing concrete to obtain a good bond between the concrete and rock foundation. When overhangs are filled with dental concrete, the concrete must be well bonded to the upper surface of the overhang. The overhang should be shaped to allow air to escape during concrete placement to prevent air pockets between the concrete and the upper surface of the overhang. The concrete must be formed and placed so that the top of the concrete is higher than the upper surface of the overhang, so that the pressure creates a tight contact. Grout pipes should be installed in the dental concrete to fill air voids. If grouting through dental concrete is done, pressures should be closely controlled to prevent jacking the concrete or fracturing the overlying spillway features. Dental concrete should have a roughened, broomed finish and be treated as a construction joint (CJ) for satisfactory bond with the overlying spillway features. Dental concrete should be cured by water or an approved curing compound for 7 days or be covered by the spillway features. Placement of concrete features may not be permitted for a minimum of 72 hours to allow time to develop sufficient strength and limit cracking potential before loading the dental concrete [38].

### 3.7.2.1.3 Grouting

The principal objectives of grouting a rock foundation are to establish an effective seepage barrier and to consolidate the foundation [36]. With the exception of rock tunnel conveyance features, grouting is typically limited to the control



**Design Standards No. 14: Appurtenant Structures for Dams  
(Spillways and Outlet Works)**

structure foundation. This section is only applicable to cement (not chemical) grout. Two types of grouting associated with spillway surface features (control structures) are discussed below:

- **Consolidation or blanket grouting** is the low-pressure injection of cement grout into the foundation to fill voids, fracture zones, and cracks at and below the surface of the excavated foundation. The purpose of this grouting is to provide a firm foundation to support loads from the structure. It is done in rock foundations when rock jointing and/or fractures are such that significant foundation deformation could occur as a result of loads from the structure. The grout is intended to provide uniformity in the foundation. This is accomplished by drilling and grouting relatively shallow holes (for concrete dams, referred to as “B holes”). The extent of the area grouted and the depth of the holes should be dependent on local conditions; however, in general, the horizontal spacing of the grout holes is around 10- to 30-foot centers (spacing), and the depth of grout holes tends to be in the range of 10 to 20 feet.

Site-specific conditions must be considered when establishing the grouting pressure; however, as a starting point, an approximate pressure is 1 lb/in<sup>2</sup> per foot of depth plus any water pressure. If the spillway is located on or near the dam abutment, grouting of the spillway control structure foundation may be a continuation of the grouting program for a dam [37].

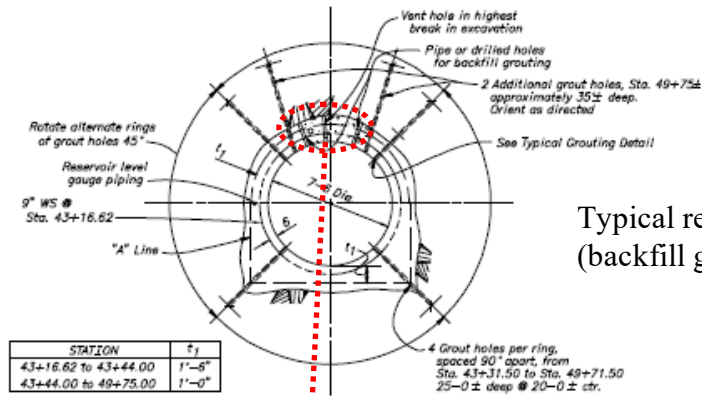
- **Curtain grouting** is high-pressure injection of cement at depth into the foundation to control seepage. The intent of this grouting is to provide an impervious foundation barrier from abutment to abutment. The grout holes (for concrete dams, referred to as “A holes” when drilled from a foundation gallery or “C holes” when drilled from the excavated or prepared surface) are typically located near the upstream limits of the spillway control structure and are usually a single line of holes drilled on 10-foot centers (although multiple lines of grouting may be needed, and wider or closer spacing may be required due to site-specific conditions). The intent is to have spacing such that grout travel overlaps from adjacent holes. To minimize the potential for damaging the foundation, curtain grouting is normally undertaken after consolidation grouting and typically after some of the control structure has been placed. This operation is accomplished from a gallery located in the control structure; however, when no gallery exists, the operation takes place from curtain holes located in or on the control structure (such as an upstream foundation cutoff). Although the depth of grout holes will be determined by site-specific conditions, general practice suggests hole depths of 30 to 40 percent of the maximum design hydrostatic head for a hard, dense foundation, and hole depths as much as 70 percent of the maximum

design hydrostatic head for a poor foundation. Site-specific conditions must be considered when establishing the grouting pressure; however, as a starting point, an approximate pressure is 1 lb/in<sup>2</sup> per foot of depth plus any water pressure. As with consolidation grouting, if the spillway is located on or near the dam abutment, grouting of the spillway control structure foundation may be a continuation of the grouting program for a dam [37].

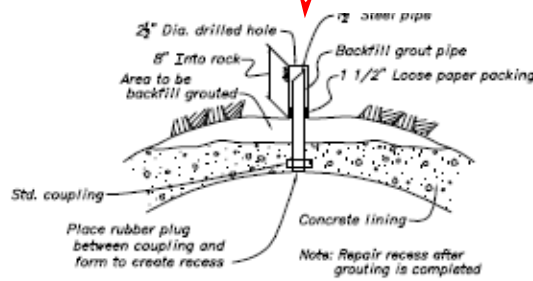
Two grouting applications, mostly associated with excavated tunnels in rock, are discussed in the following paragraphs.

- **Backfill grouting** is used to fill any voids between a structural feature, such as the outside limit of a reinforced concrete tunnel placement, and the excavated limits of the surrounding rock foundation. Application of backfill grouting focuses on areas where gravity tends to create voids, such as near the crown (top) of a tunnel liner. Backfill grouting should not occur until the concrete feature (such as a tunnel liner) has achieved its design (compressive) strength (such as 4,500 lb/in<sup>2</sup> at 28 days). Low pressures are used, which are in the range of 15 to 30 lb/in<sup>2</sup> plus any water pressure (see figure 3.7.2.1.3-1 for more details).
- **Ring or pressure grouting** is similar to consolidation grouting where the intent is to inject low-pressure cement into the surrounding tunnel foundation to fill voids, fracture zones, and cracks within at least 20 to 25 feet of the excavation limits of the tunnel. The ring grout line (i.e., multiple grout holes around the perimeter of the tunnel at a given location or station along the tunnel) along the tunnel is typically spaced at 20-foot centers. Location and number of grout holes in a ring grout line are site specific, but they tend to be spaced between 45 and 90 degrees around the perimeter of the tunnel. It is common for a ring grout line to be offset (rotated) 45 degrees from the previous and subsequent ring grout line. Also, drilling grout holes and pressure grouting will not be initiated until backfill grouting has been completed within approximately 100 feet upstream and downstream from the ring grout line location (see figure 3.7.2.1.3-2 for more details). It should be noted that, depending on foundation conditions, ring grouting may be replaced with backfill (crown) grouting combined with weep (drainage) holes (see Section 3.7.3.1, “Drainage,” for more details) for tunnel sections downstream from the dam foundation grouting.

**Design Standards No. 14: Appurtenant Structures for Dams  
(Spillways and Outlet Works)**

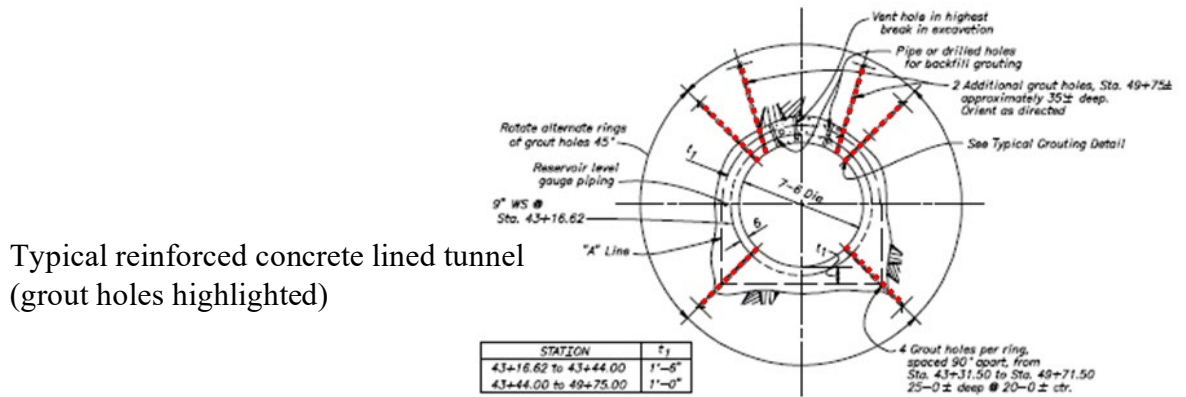


Typical reinforced concrete lined tunnel  
(backfill grout location circled)

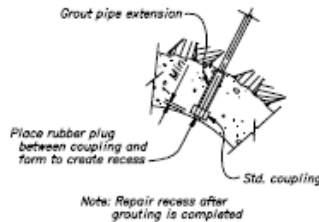


Backfill grout detail

**Figure 3.7.2.1.3-1. Backfill grouting.**



Typical reinforced concrete lined tunnel  
(grout holes highlighted)



Ring grout detail

**Figure 3.7.2.1.3-2. Ring or pressure grouting.**

### 3.7.2.1.4 Cleanup

Foundation cleanup can be labor intensive and costly, but it must not be neglected. Proper cleanup of a foundation before concrete placement increases the likelihood that the contact area will meet design intent in terms of the compressive and shear strength, along with permeability. Poor foundation cleanup can result in reduced bonding and compressive and shear strengths, leading to weak zones and providing a permeable path for seepage [38]. To ensure proper cleanup of a foundation, both cleaning and water removal need to be fully addressed.

- Cleaning rock foundations includes barring and prying loose any drummy<sup>41</sup> rock, using an air/water jet to remove as much loose material as possible, and removing (by hand) loose material that an air/water jet misses. Cleaning soil foundations should include removing loose or disturbed materials missed by machine excavation that will not be suitable foundation even after compaction (if needed) [38].
- Water in small quantities can be removed from a rock foundation by vacuuming (with a shop-vac or air-power venturi pipe) or other approved methods. Large water quantities from seeps can be isolated, and gravel sumps can be constructed, pumped, and subsequently grouted. Another approach for both rock and soil foundations is using well points, which can temporarily stop the seeps and/or lower the ground water several feet below the foundation contact, allowing placement of the concrete [38]. It should be noted that, in some cases, it may be necessary to install well points before beginning excavation. Finally, the rock foundation should be washed or wetted before placing concrete to achieve a saturated surface dry (SSD)<sup>42</sup> condition.

### 3.7.2.1.5 Anchors and Cutoffs

Anchors and cutoffs are important design considerations that should not be overlooked. These features are used to further stabilize the spillway and foundation.

- **Anchors.** – These features could include anchor bars, rock bolts, and post-tensioned anchors and are usually associated with a rock foundation (there are some limited applications using soil anchors or soil nails, but this is the exception, not the rule, for stabilizing the spillway and soil foundation).

---

<sup>41</sup> Drummy rock is associated with a foundation that has delaminated or separated layers or blocks.

<sup>42</sup> SSD condition is achieved when the foundation surface pores are saturated and free surface water and puddles have been removed from the surface of the foundation. This is the optimal time to place new concrete on the foundation surface.

## Design Standards No. 14: Appurtenant Structures for Dams (Spillways and Outlet Works)

- **Anchor bars.** – The most common anchor with the least tensile capacity is the anchor bar, which is primarily used to stabilize the spillway control structure, conveyance feature, and terminal structure floors and, in some cases, walls (most Reclamation spillways with rock foundations include anchor bars as a design detail). Anchor bars are a passive anchoring system that is designed to provide adequate factors of safety for stability. The anchor bars are typically spaced in a 5- to 10-foot grid pattern, which is governed by the floor or wall dimensions between joints. Anchor bar sizes typically range from No. 8 to No. 11 reinforcing bars. Anchor bars are placed in drilled foundation holes and cement grouted in place with a portion of the anchor bar equal to embedment length extending out of the foundation (standard hook length as noted by standard drawing 40-D-6263 and/or the current American Concrete Institute [ACI] code if floor or wall thickness is not sufficient to contain embedment length without bending). This embedment length will be encased in the reinforced concrete floor or wall (see figure 3.7.2.1.5-1 for more details).
- **Rock bolts.** – The grouted rock bolt is a less frequently used anchor with more tensile capacity than the anchor bar. Rock bolts are extensively used to stabilize spillway tunnel excavated surfaces (such as Reclamation’s Blue Mesa Dam service spillway). On occasion, grouted rock bolts are also used to stabilize steep rock excavation in spillway chutes and terminal structures (such as Reclamation’s Stewart Mountain Dam auxiliary spillway and stabilizing the spillway flip bucket rock foundations at Reclamation’s Theodore Roosevelt Dam). Rock bolts provide active compressive forces within the rock mass, but are generally treated as passive anchors within the concrete. Spacing and size of rock bolts are based on site-specific analysis/design results (see figure 3.7.2.1.5-2 for more details).
- **Post-tensioned anchors.** – The least used anchor with the greatest tensile capacity (compared to the anchor bar and rock bolt) is the post-tensioned anchor. Reclamation’s experience with post-tensioned anchors associated with spillways includes the stabilization of the National Park Service’s Elwha and Glines Canyon Dams, which have since been removed. Some nonspillway applications have addressed concrete dam stability issues (such as Reclamation’s Stewart Mountain Dam and Minidoka Dam). These anchors generally provide active resistance to loads. This is accomplished by anchoring through concrete into the rock foundation. Tensioning provides compression across the foundation (concrete-rock) contact. Design procedures are based on the Post-Tensioning Institute’s *Recommendation for Prestressed Rock and Soil Anchors* [40] (see figure 3.7.2.1.5-3 for more details).

### Chapter 3: General Spillway Design Considerations

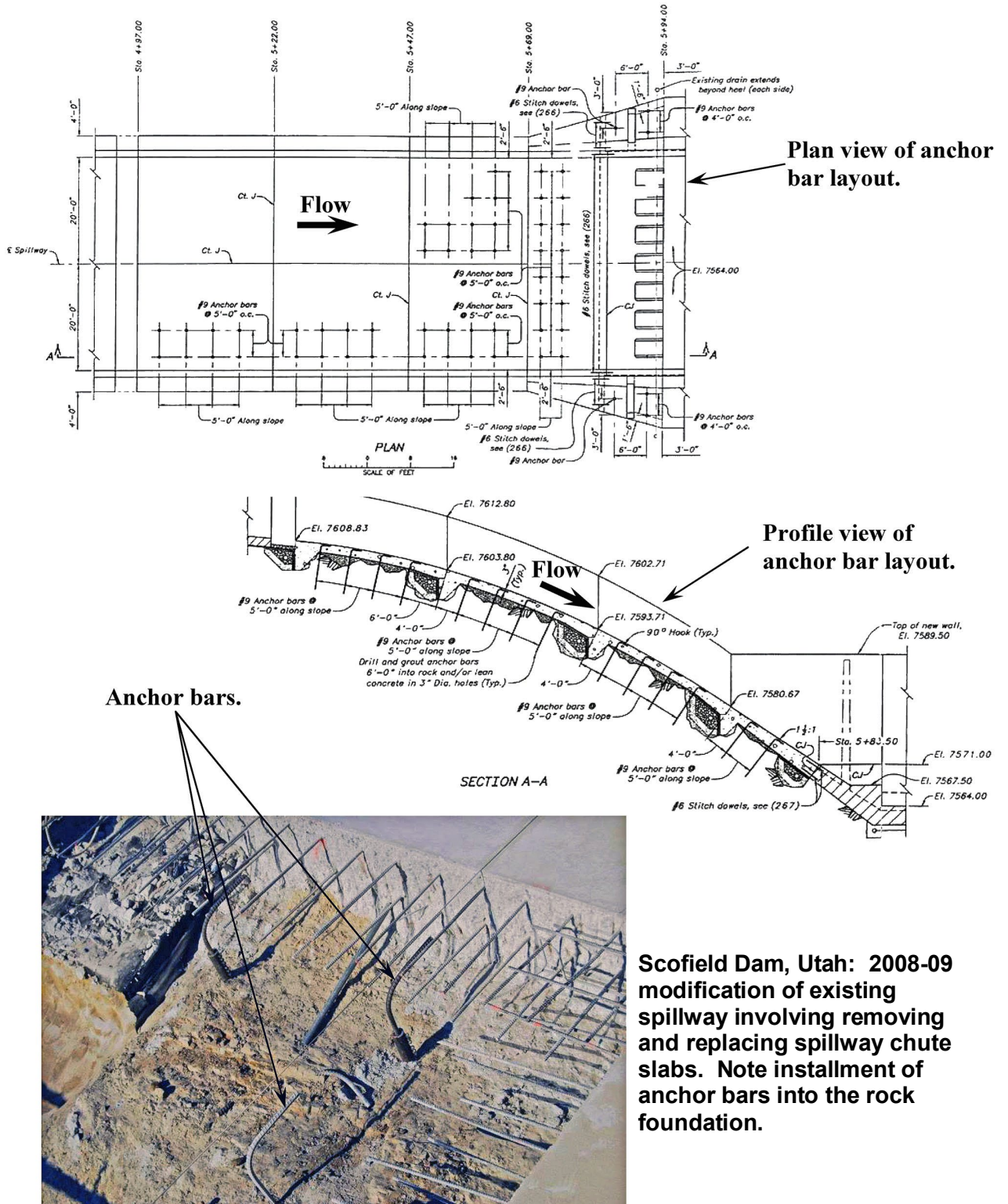
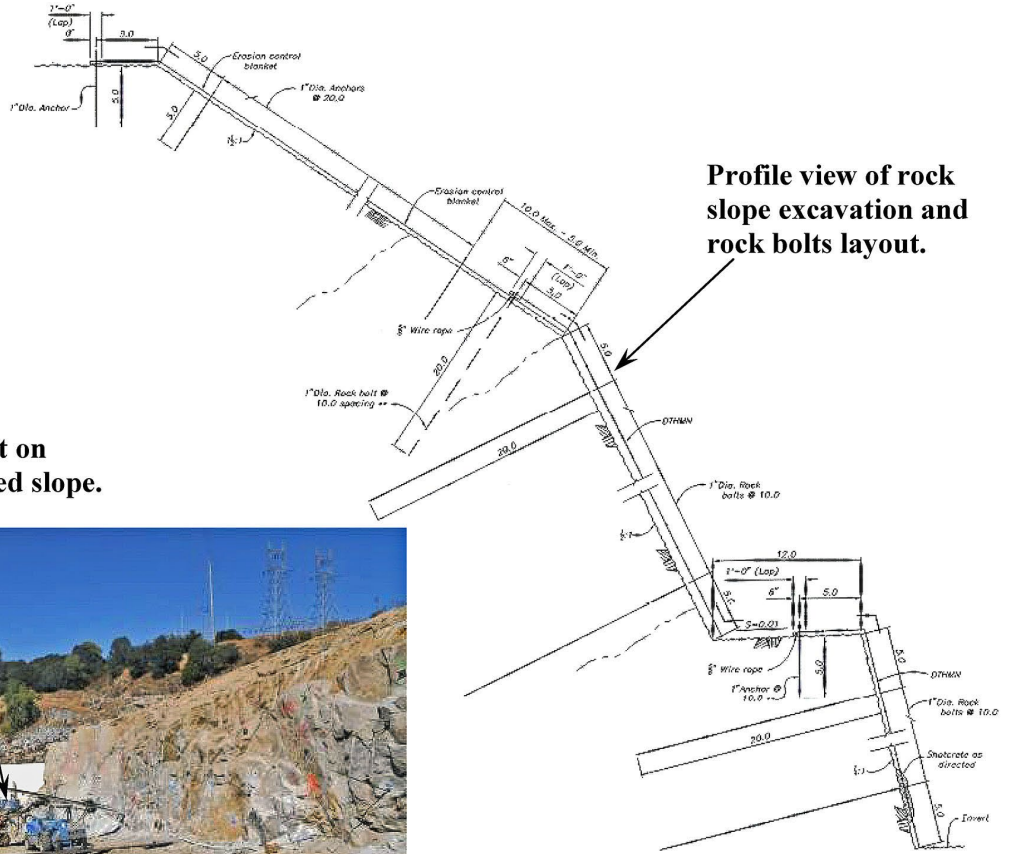


Figure 3.7.2.1.5-1. Anchor bars.



**Design Standards No. 14: Appurtenant Structures for Dams  
(Spillways and Outlet Works)**



**Drilling rock bolt on spillway excavated slope.**



**Folsom Dam, CA – 2009-17 Constructing new Joint Federal Project auxiliary spillway.**

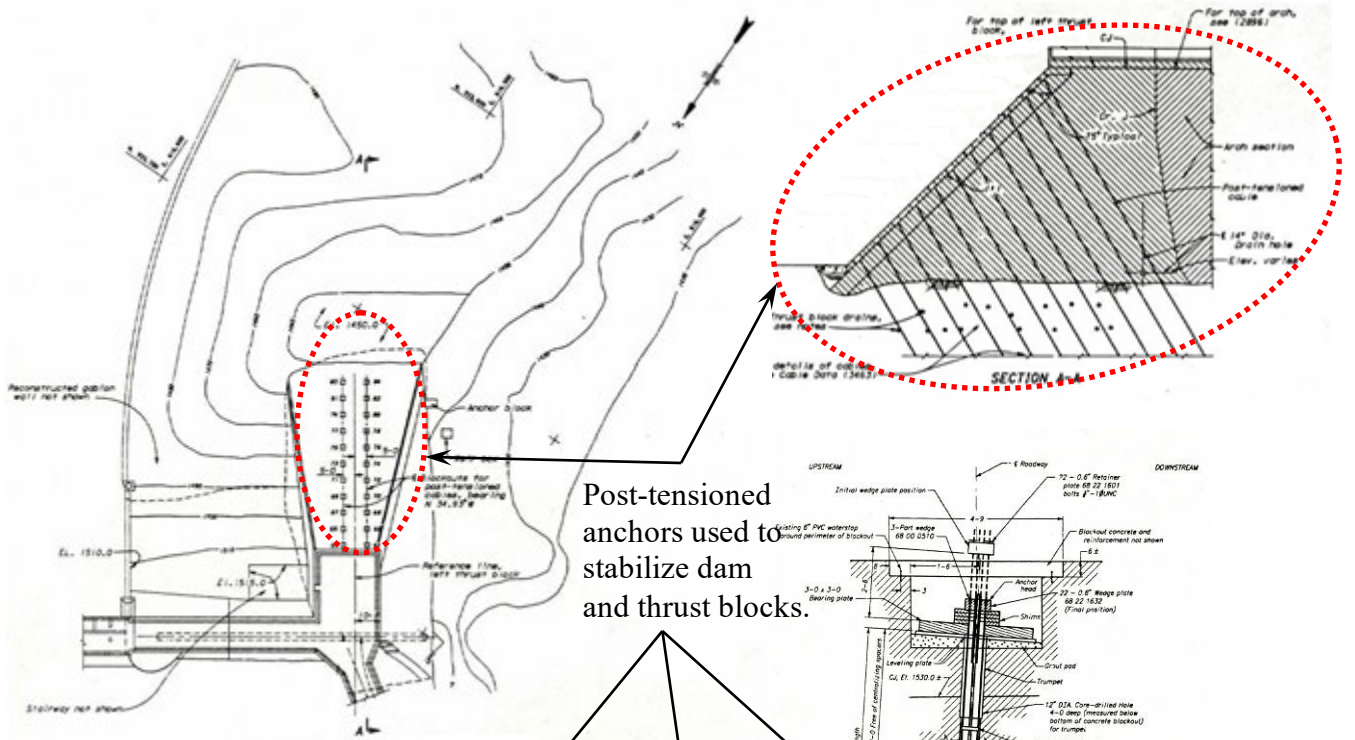
**Rock bolts securing wire mesh on spillway excavated slope.**

**Shotcrete being placed over rock bolts and wire mesh.**

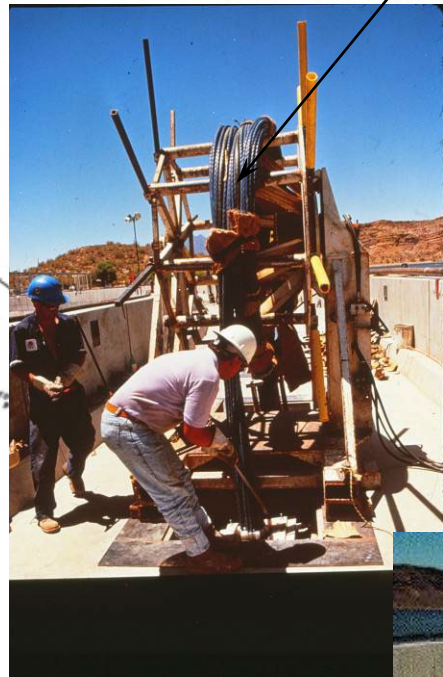
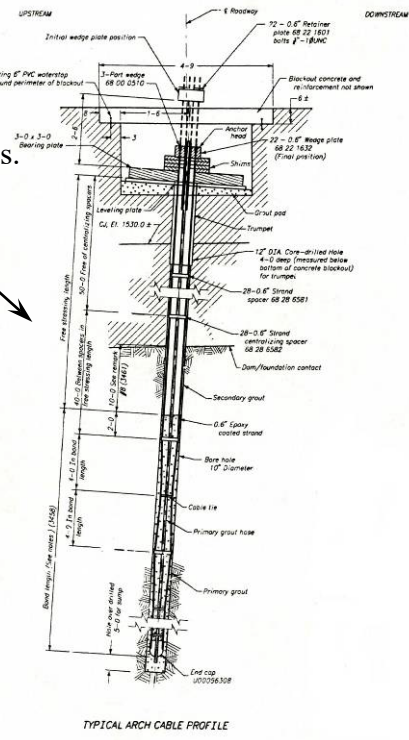


**Figure 3.7.2.1.5-2. Rock bolts.**

### Chapter 3: General Spillway Design Considerations



Post-tensioned anchors used to stabilize dam and thrust blocks.



Stewart Mountain Dam Modifications, AZ – 1992  
Stabilizing dam and modified existing river outlet works.

Figure 3.7.2.1.5-3. Post-tensioned anchors.



## Design Standards No. 14: Appurtenant Structures for Dams (Spillways and Outlet Works)

- **Cutoffs.** – These features could include reinforced concrete keys, secant piles, soil cement, or RCC diaphragm walls, and they are associated with both rock and soil foundations (see figure 3.7.2.1.5-4 for more details). The following paragraphs are taken from the *Design of Small Dams* [3] and summarize general guidance associated with cutoffs.
- One or more cutoffs are generally provided at the upstream end of a spillway for various purposes. They can be used to form a watertight curtain against seepage under the structure, or they can increase the path of percolation under the structure and thus reduce uplift forces. Cutoffs can also be used to intercept permeable strata in the foundation to minimize seepage and help prevent a buildup of uplift pressure under the spillway or adjacent areas. When the cutoff trench for the dam extends to the spillway, it is generally joined to the upstream spillway cutoff to provide a continuous barrier across the abutment area. In jointed rock the cutoff may act as a grout cap for a grout curtain, which is often extended across the spillway foundation.
- A cutoff is usually provided at the downstream end of a spillway structure as a safeguard against erosion and undermining of the end of the structure. Cutoffs (or foundation keys) at intermediate points along the contact between the spillway features (primarily conveyance features and terminal structures) and the foundation serves to lengthen the path of percolation under the spillway features. Wherever possible, cutoffs in rock foundations are placed in vertical trenches. In earth foundations where the cutoffs must be formed in a trench with sloping sides, care must be taken to compact the trench backfill properly with impervious material to obtain a reasonably watertight barrier. Structure underdrains with granular backfill may be located just upstream of intermediate and downstream cutoffs (see Section 3.7.3, “Drainage and Insulation,” in this chapter for more details).

### 3.7.2.2 Foundation Acceptance

During the design, it is very important to clearly define what is, and is not, an acceptable (adequate) foundation, which will help establish the foundation inspection and approval process aimed at ensuring that design intent is being met during construction, as described in the following sections. These sections include:

- **Foundation inspection and acceptance procedures**, see section 3.7.2.2.1 in this chapter.
- **Critical foundation areas**, see Section 3.7.2.2.2 in this chapter.
- **Documentation**, see Section 3.7.2.2.1 in this chapter.

Chapter 3: General Spillway Design Considerations

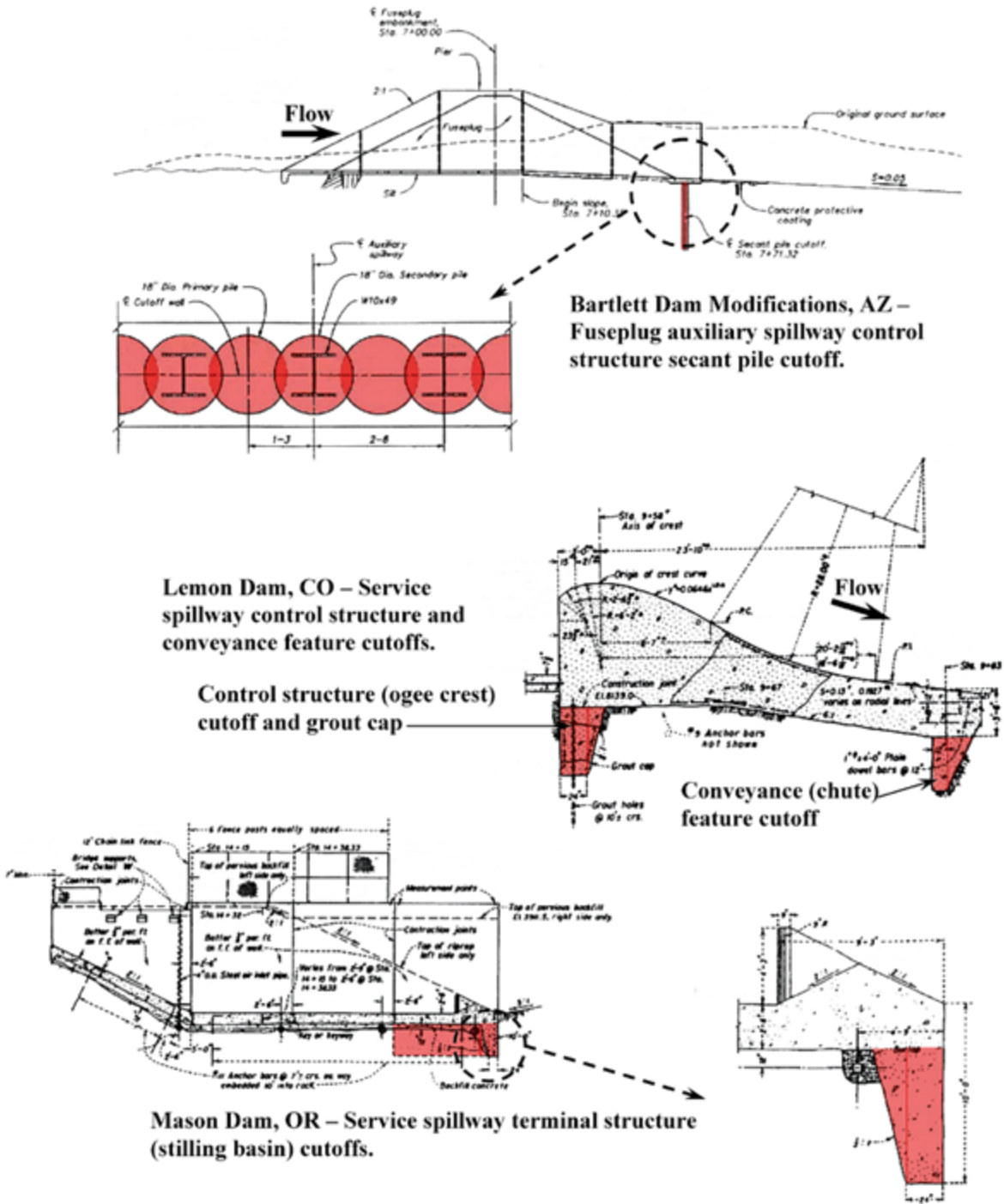


Figure 3.7.2.1.5-4. Cutoffs.

**Design Standards No. 14: Appurtenant Structures for Dams  
(Spillways and Outlet Works)**

**3.7.2.2.1 Foundation Inspection and Acceptance Procedures**

As part of the design for a modified or new spillway, foundation inspection and acceptance procedures should be developed. This first requires a definition of what is an acceptable foundation, versus an unacceptable foundation, for the spillway features. Once this has been clarified, the following should be included in the development of the inspection and acceptance procedures:

- Consider treatment measures where an inadequate foundation is identified.
- Apply protective measures to ensure the integrity of an adequate foundation once it has been prepared and prior to placing the spillway features on the foundation.
- Develop procedures to be used when inspection and approval is made onsite by the designer of record, geologist, and field personnel.
- Develop procedures to be used when inspection is made by field personnel and approval is made via telephone by the designer of record.
- Identify appropriate field testing to be conducted prior to or during the foundation inspection and approval.
- Prepare a foundation inspection checklist, which should be completed during all foundation inspections and approvals.
- Provide adequate documentation of foundation conditions, including geologic mapping and photographs of the foundation area being inspected. Sufficient detail should be provided so that future problems, should they develop, can be understood based on the documentation.

For more details, refer to Chapter 6, “Structural Considerations for Spillways and Outlet Works,” in this design standard.

**3.7.2.2.2 Critical Foundation Areas**

Identify critical and noncritical foundation areas and how they will be inspected and approved. There are several considerations used to identify critical and noncritical foundation areas, including:

- Critical foundation areas are typically associated with significant loading and settlement/deformation potential, significant seepage potential, and/or tied to PFMs. Typical spillway features associated with critical foundation areas include control structures, conveyance features, and terminal structures. Noncritical foundation areas would be the remainder of the spillway foundation areas not identified as critical.
- Critical foundation areas may also include areas that have not had an initial inspection or areas that previously have been inspected and approved but are now exhibiting differing foundation conditions than at the time of previous approval. Noncritical foundation areas are typically areas exhibiting similar conditions to those that have already been inspected and approved.

For critical areas, an onsite foundation inspection and approval should be planned for, involving the designer of record and geologist. For noncritical areas, an onsite inspection and approval process will typically be carried out by the field personnel, who must be aware of, and able to identify, dissimilar, irregular, or unusual conditions that would require additional follow-up and evaluation (such as the same level of onsite inspection and approval required for critical foundation areas). For more details, refer to Chapter 6, “Structural Considerations for Spillways and Outlet Works,” in this design standard.

### **3.7.2.2.3 Documentation**

A decision memorandum (DM) will be prepared for each foundation inspection. A draft DM should be prepared by the designer of record before the foundation inspection and approval when the designer of record is directly involved (onsite). A draft DM should be prepared by field personnel before the foundation inspection and approval when the designer of record is not directly involved (telephone approval). This draft DM should be provided to the designer of record prior to the telephone approval. With few exceptions, the DM for both cases should be finalized and signed within 7 working days following the foundation inspection. However, it is recognized that there will be circumstances when the DM cannot be finalized within this time period. When this occurs, the designer of record will coordinate with other involved parties to identify a timely and mutually agreed to completion date. See Chapter 6, “Structural Considerations for Spillways and Outlet Works,” in this design standard for more details on the contents of a DM and an example of a DM.

## **3.7.3 Drainage and Insulation**

Both drainage and insulation are important considerations that should be fully evaluated during designs of modified and new spillways. Inadequate or inappropriate drainage and insulation designs can lead to significant damage and/or failure of spillway features.

**Design Standards No. 14: Appurtenant Structures for Dams  
(Spillways and Outlet Works)**

**3.7.3.1 Drainage**

Drains beneath and/or adjacent to appurtenant structures should be provided to control excessive water pressure, which might lead to instability, including failure of the spillway feature or its foundation. Even a minor amount of groundwater can result in structural damage if it is not drained freely and is allowed to build up pressure or if it can cause frost-heave during freezing temperatures. Historically, it has been Reclamation's practice to design appurtenant structures to withstand part or all of the anticipated water pressure (i.e., assuming drains are not functioning or are only partially effective). It has been (and is considered prudent) engineering practice to provide drainage to critical appurtenant structures (i.e., an appurtenant structure is considered critical if increased risk to the dam and/or downstream consequences could result from an inability to operate and/or failure). As cited in detail in the *Frost Action in Soil Foundations and Control of Surface Structure Heaving Report* [41] and the *Drainage for Dams and Associated Structures* [42], the following considerations should be included:

Locations of drainage features should be limited to the control structure and downstream spillway features (i.e., drainage associated with the control structure, conveyance feature, and terminal structure) and isolated from the reservoir. If drainage is needed for spillway features upstream of the control structure (such as an inlet structure), the drainage features should not extend to the drainage features associated with the control structure and other downstream spillway features. For more information concerning these drainage features, see figures 3.7.3.1-1, 3.7.3.1-2, and 3.7.3.1-3. Also, refer to Section 3.8.6.1.2-1, "Contraction Joints (CrJ)," and Section 3.8.6.1.3-1, "Control Joints (CtJ)," in this chapter

- Minimize disturbance of the foundation, particularly for rock foundations. For more information concerning these drainage features, see figure 3.7.3.1-1. Also, refer to Sections 3.8.6.1.2, "Contraction Joints," and 3.8.6.1.3, "Control Joints," in this chapter.

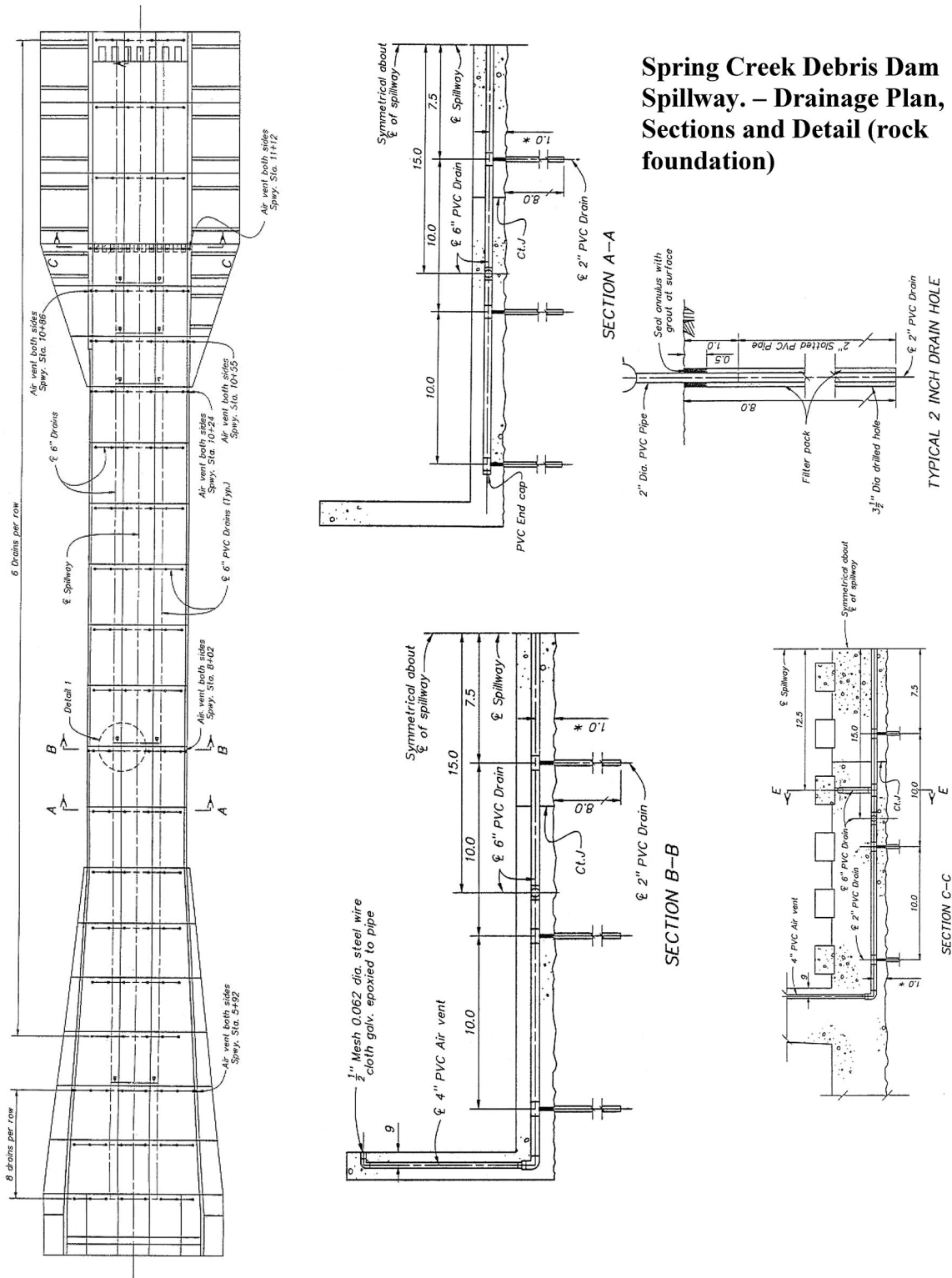
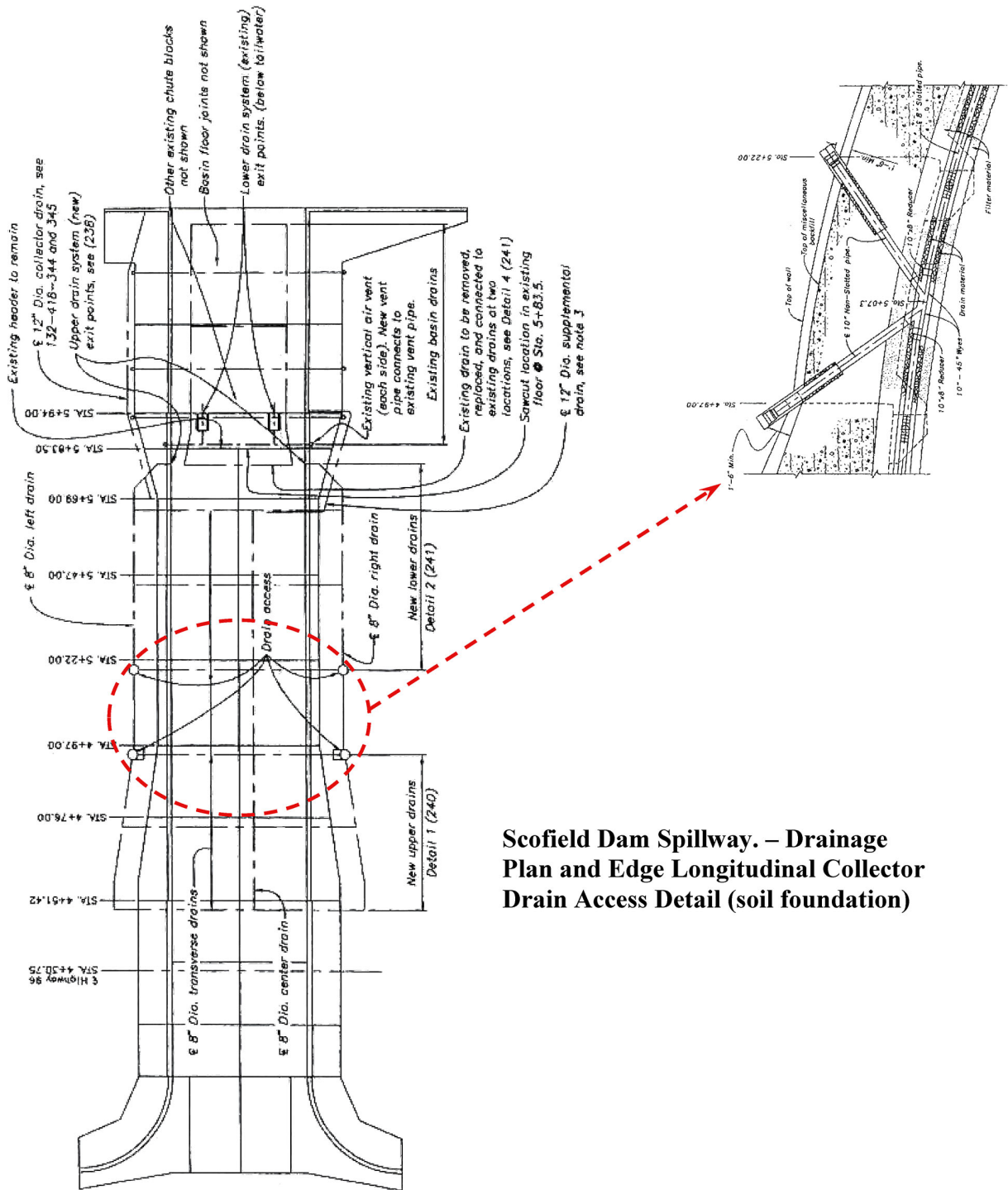


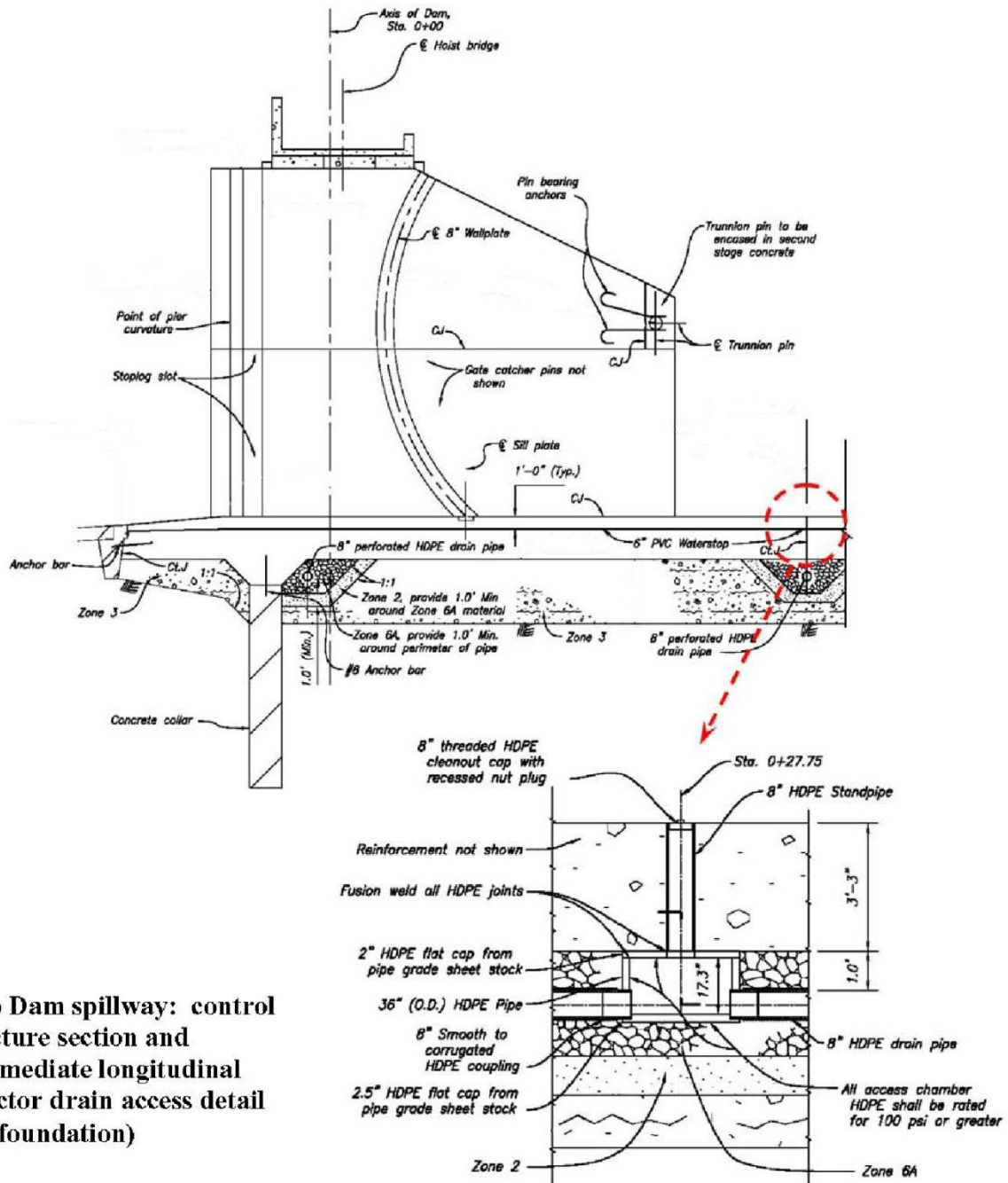
Figure 3.7.3.1-1. Drainage.

**Design Standards No. 14: Appurtenant Structures for Dams  
(Spillways and Outlet Works)**



**Scofield Dam Spillway. – Drainage Plan and Edge Longitudinal Collector Drain Access Detail (soil foundation)**

**Figure 3.7.3.1-2. Drainage access – outside longitudinal collectors.**



Echo Dam spillway: control structure section and intermediate longitudinal collector drain access detail (soil foundation)

Figure 3.7.3.1-3. Drainage access – inside longitudinal collectors.



## Design Standards No. 14: Appurtenant Structures for Dams (Spillways and Outlet Works)

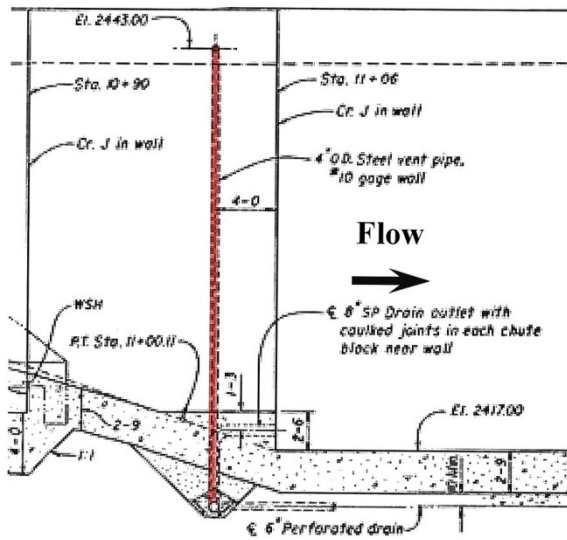
- Drain access and cleanout capabilities should be included in drainage features. For more information concerning drain access and cleanout features, see figures 3.7.3.1-2 and 3.7.3.1-3.
- For spillway surface features, drainage systems are typically laid out in a grid pattern with spacing of the grid in both the longitudinal (upstream-downstream) and transverse (lateral or cross-canyon) direction, and they are influenced by expected flow and loss of drainage efficiency over time. Typically, transverse drain spacing is the same as the floor slab joint spacing. Longitudinal collector drains can be located at the outside edges when the spillway feature (such as a chute) is less than 30 feet wide. When the spillway feature is 30 feet wide or greater, intermediate longitudinal collector drains spaced between the edge longitudinal collector drains should be considered [42]. Also, when a spillway is located on or near a concrete dam abutment, the dam foundation drains may be continued across the spillway control structure foundation.
- For spillway tunnel conveyance features, drainage (weep) holes are often provided in nonpressurized (free flow) tunnels to relieve external pressure caused by seepage along the outside of the tunnel lining. Drainage holes should be located above the anticipated maximum water surface. The drainage holes are commonly spaced at about 20-foot centers in the upstream-downstream direction, at intermediate locations between the ring grout holes (for more details, refer to Section 3.7.2.1.3, “Grouting,” in this chapter). At successive drainage locations along the tunnel, one vertical hole is drilled near the crown (top), alternating with two drilled horizontal or near horizontal holes (one on each side) [36]. Drainage holes are located using embedded pipe inserts through the concrete liner and are drilled after the concrete has set. To avoid cutting the reinforcing bars, drilling drainage holes directly through the concrete should be prohibited. Also, drainage holes should not be drilled until backfill and ring grouting has been completed at least 150 feet from the drainage holes.
- Filter requirements can influence type, size, and location of the drainage system. Detailed guidance can be found in Chapter 5, “Protective Filters,” in Design Standards No. 13.
- Where freezing temperatures are possible, drains should be constructed such that they will not freeze and plug with ice.

- As a general rule, pervious backfill or other free-draining materials are placed adjacent to retaining walls and conduits when free drainage must be maintained. Free-draining material in cold weather climates will help limit frost penetration and ice lenses, which could lead to frost heave.
- Consideration should be given to mitigating contamination potential from adjacent concrete placement during construction. Historically, this has been accomplished with insulation material, burlap, geotextiles, geomembranes, and/or steel wool (within weep holes) as a barrier between drains (including pervious material placed around a drain pipe) and fresh concrete.
- Particularly for appurtenant structures (such as spillways and outlet works) associated with high velocity, high volume releases, care must be taken so that the drainage system is not subjected to adverse hydraulics, which can damage or fail the appurtenant structure. Two conditions that should be evaluated include: (1) excessive back pressure, which could introduce hydrostatic (uplift) pressure beneath a spillway conveyance feature and/or terminal structure; and (2) stagnation pressure that could be introduced through cracks and/or open joints along a conveyance feature and/or terminal structure, leading to pressurizing the drainage system [42]. In other words, there should generally be no direct path (such as drains, open joints or cracks) through the floor slabs and walls that are subject to high velocity, high volume flow conditions.
- Air demand must be considered, which could be associated with providing a “vacuum break” to allow air to eliminate lowered pressures induced by high velocity flow across drain outlets (see figure 3.7.3.1-4). Inlets or intakes which provide the air should be located above the maximum tailwater level.

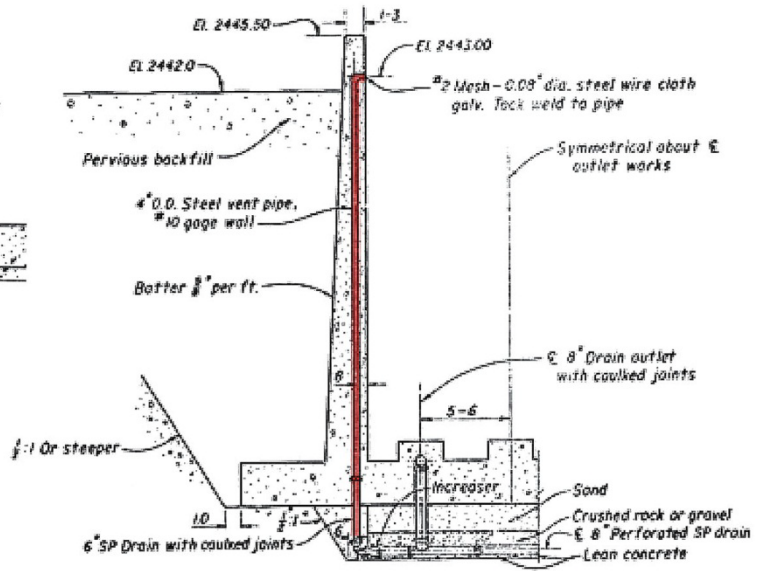
#### 3.7.3.2 Insulation

Considerable damage and/or failure can result from freezing foundations and adjacent materials. Unheated appurtenant structure surfaces in contact with frost-susceptible backfill or foundation exposed to water are subject to frost penetration, ice lenses, and subsequent loading (frost heave) that can be significant. To address this concern, insulation requirements are employed to protect drainage systems associated with concrete slabs and walls. Also, consideration should be given to the compressibility of the insulating materials and their long-term durability. Typical insulation materials include rigid polystyrene insulating materials (see figure 3.7.3.2-1). For further details, refer to *Frost Action in Soil Foundations and Control of Surface Structure Heaving* [41] and *Drainage for Dams and Associated Structures* [42].

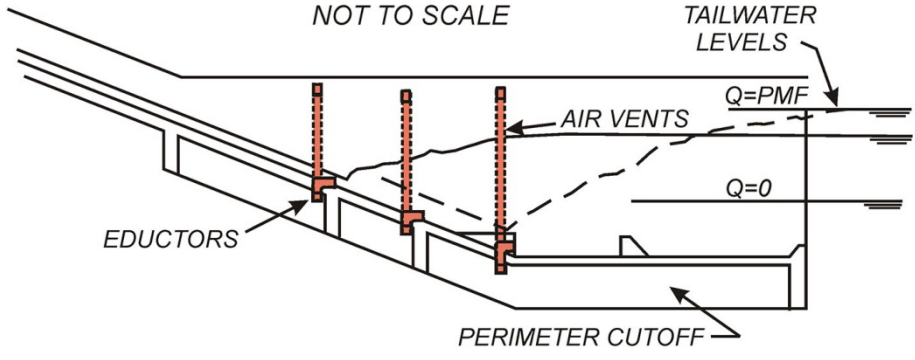
**Design Standards No. 14: Appurtenant Structures for Dams  
(Spillways and Outlet Works)**



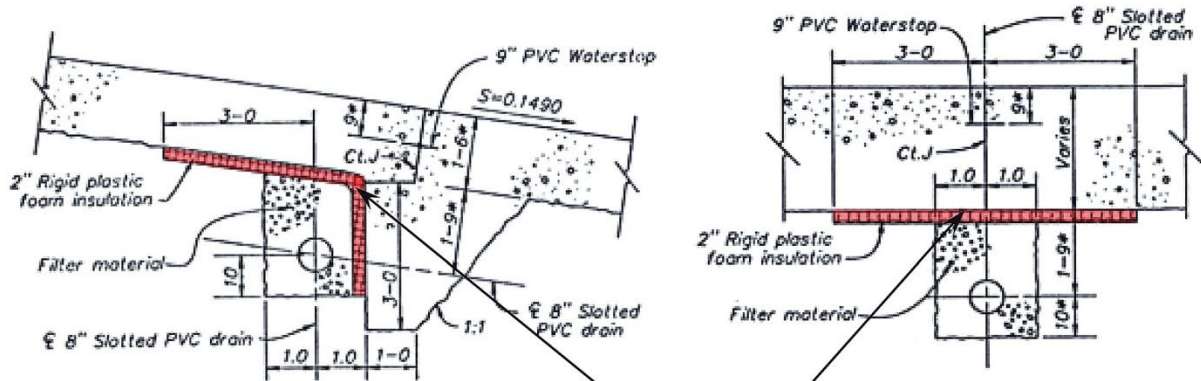
**Keechelus Dam, WA – Service spillway chute and stilling basin sections showing the (vacuum-break) vent pipes for the underdrain system.**



**Spillway chute and stilling basin section showing the (air demand) eductors or aspirators which may be needed when high velocity flow moves across drain outlets. For more information see *Drainage for Dams and Associated Structures* [40].**



**Figure 3.7.3.1-4. Air supply/demand.**



**Insulation**



**Reinforcement**

**Control joint (Ct. J.)**

**Waterstop**



**McDonald Dam (BIA), MT – 1995 New service spillway – Note ridge polystyrene insulating materials (stockpiled in upper photograph; installed on either side of waterstopped control joint, below reinforcement and above underdrains in right photographs).**

**Figure 3.7.3.2-1. Insulation.**

## **3.8 General Structural Considerations**

This section provides general structural considerations for determining the type, location, and size of a modified or new spillway. Detailed structural analysis and design can be found in Chapter 6, “Structural Considerations for Spillways and Outlet Works,” in this design standard.

As previously noted, unless specified otherwise, this chapter is applicable to the evaluation, analysis, and design of reinforced concrete for high velocity and high flow spillways. Also, it should be noted that although national building codes are applicable and establish minimum structural design requirements, quantitative risk analysis methodology must be considered for design of hydraulic structures. As a result, design requirements for spillways will generally equal or exceed national building code requirements. It should also be stressed that quantitative risk analysis methodology should never be used to reduce established codes, standards, and/or criteria. In addition, serviceability requirements, such as the need to limit cracking of structural concrete for hydraulic structures, are a key consideration for modification designs for existing spillways and designs for new spillways.

### **3.8.1 Loading Conditions**

The following discussion summarizes typical loading conditions for designing a new spillway or modifying an existing spillway.

The more typical loading conditions follow and will address most spillway designs. However, there could be unique loading conditions associated with a given site and/or operations of a spillway which should be included with these more typical loading conditions:

- **Reservoir and tailwater loads.** – The normal reservoir load is associated with the maximum normal RWS (either the top of active conservation or the top of joint use storage, whichever is higher). The maximum reservoir load is associated with the maximum flood-induced RWS. The tailwater load may be associated with either the minimum or maximum downstream water surface expected to occur with a given RWS. For usual, unusual, and extreme loading combinations associated with stability evaluation, see Section 3.8.3, “Stability Design,” in this chapter. For structural design methods, see Section 3.8.4, “Reinforced Concrete Design,” in this chapter.
- **Temperature loads.** – Temperature-induced loads result from variations of concrete temperatures with the “stress free” temperature, which is typically associated with the initial set (hardening) of the concrete. To

estimate temperature loads, the initial set is assumed to occur at the maximum heat of hydration temperature (occurring in the range of 2 to 6 days after concrete placement). The stress free temperature is the sum of the placement temperature and the maximum heat of hydration temperature. As an example, for a concrete placement temperature of 60 degrees Fahrenheit (°F) and a maximum heat of hydration temperature of 30 °F, the stress free temperature would be 90 °F. Without artificial cooling, the concrete could require several weeks to multiple months before reaching a stable annual heating and cooling cycle. Concrete temperatures greater than the stress free temperature will result in expansion of the concrete, while temperatures less than the stress free temperature will result in contraction of the concrete. Particularly near the concrete surface, concrete temperature can vary greatly due to air temperatures and radiant heat. As an example, at some locations, it is common for temperatures to range from considerably below 0 °F to over 130 °F. See figure 3.8.1-1 for illustrating concrete temperatures with time. This potentially large variation from the stress free temperature can lead to tensile stress cracking due to contraction (typically hair-line surface cracks some distance away from joints) and compression cracking due to expansion (typically spalling and/or delamination near joints). It should also be noted that adjacent concrete placements may not have the same set temperature.

It should be highlighted that the current industry practice of grinding cement much finer than in the past tends to increase the potential for higher concrete temperatures, along with increased and/or more rapid strength gain during the curing process. Because of this practice it is very important to fully evaluate and develop concrete mix designs that will meet design intent, along with actions needed to accommodate high temperatures during the curing process and associated cracking potential. Finally, it should be noted that current (new) concrete materials are not necessarily compatible with older (existing) concrete, and care must be taken when designing modifications to existing concrete structures.

Unless a site-specific temperature study is undertaken, temperature loads are handled by requiring that temperature reinforcement be provided. For hydraulic structures, minimum temperature reinforcement should be based on the requirements of ACI 350-06 [47] and a minimum of No. 6 bars at 1-foot spacing, each way, each face [37]. For other (above ground) structures, the requirements of Section 7.12 of ACI 318-11 [48] may be appropriate. An area equivalent to No. 9 bars at 1-foot spacing, each way, each face should be considered a maximum for temperature reinforcement unless supported by more detailed structural analysis. Also, details are incorporated into floor slab joint design to address large near-surface temperature variations (for more details, see Section 3.8.6, “Joints,



**Concrete Temperature History (Example)**  
Evaluation of Joint Spacing and Cracking Potential for Concrete Slabs and Walls

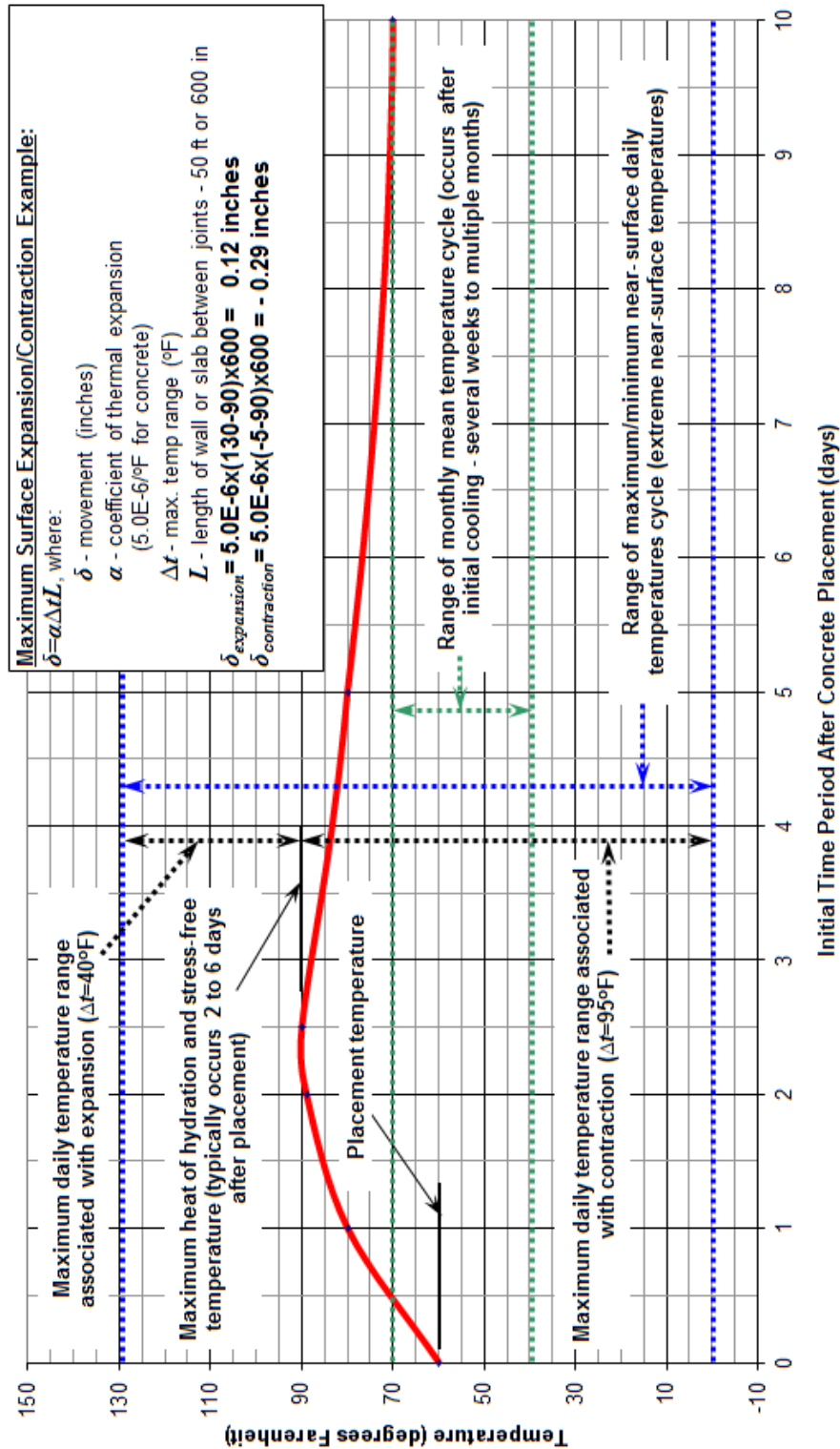


Figure 3.8.1-1. Concrete temperature history.

Waterstops, and Tolerances,” in this chapter). For additional discussion of temperature reinforcement, see Chapter 6, “Structural Considerations for Spillways and Outlet Works,” found in this design standard.

- **Uplift loads.** –The normal uplift load (in the foundation) and/or external hydrostatic pressure is associated with the phreatic line<sup>43</sup> which varies between the maximum normal RWS (either the top of active conservation or the top of joint use storage, whichever is higher) and the associated minimum tailwater surface expected to occur with the RWS. The maximum uplift load and/or external hydrostatic pressure is associated with the phreatic line which varies between the maximum flood-induced RWS and the minimum tailwater surface [37]. An exception to assuming minimum tailwater conditions during a flood event would be a hydraulic jump stilling basin that has the critical location at the upstream end of the stilling basin. This location is associated with minimum flow depth ( $d_1$ ) before the hydraulic jump and the uplift equal to the full tailwater depth (equal to or greater than  $d_2$ ) after the hydraulic jump. Flow-net analysis may be needed to estimate uplift loads. For usual, unusual, and extreme loading combinations associated with stability evaluation, see Section 3.8.3, “Stability Design,” in this chapter. For structural design methods, see Section 3.8.4, “Reinforced Concrete Design,” in this chapter.
- **Dead loads.** - The dead load is equal to the weight of the spillway concrete and any mechanical features. If no site-specific data are available, the unit weight of concrete ( $\gamma_c$ ) can be assumed to equal 150 lb/ft<sup>3</sup>. Also, when applicable, the dead load will include earthfill (soil) and water loads. If no site-specific data are available, the unit weight of 120 lb/ft<sup>3</sup> for pervious backfill and 130 lb/ft<sup>3</sup> for embankment material (dry soil), and 135 lb/ft<sup>3</sup> (saturated soil) can be used as default values.
- **Ice loads.** – The ice load (in the reservoir or tailwater) is based on site-specific data. If site-specific data are not available, procedures found in the *Report of the Task Committee on Design Criteria for Retaining Walls* [44] can be used to estimate ice loads. A default acceptable estimate of ice load is 10,000 pounds per linear foot (lb/lf) of contact between the ice and structure for an assumed depth of 2 feet or more when basic data are not available [37]. Of note, defensive design

---

<sup>43</sup> Phreatic line is the free surface of water seeping at atmospheric pressure through soil or rock.



## Design Standards No. 14: Appurtenant Structures for Dams (Spillways and Outlet Works)

measures (such as free-draining fill<sup>44</sup> next to the walls and other drainage features) are used to mitigate ice loads associated with frost heave downstream of the spillway control structure (along conveyance features such as chutes), so ice loads are limited to spillway features exposed to the reservoir or tailwater. It should be noted that ice loads are typically not considered for spillway gates. If ice is a concern, other measures, such as bubbler systems or heating the gate wall plates, are pursued. For more information about mitigating frost heave, refer to *Frost Action in Soil Foundations and Control of Surface Structure Heaving* [41] and *Drainage for Dams and Associated Structures* [42]. For usual loading combinations associated with stability evaluation, see Section 3.8.3, “Stability Design,” in this chapter. For structural design methods, see Section 3.8.4, “Reinforced Concrete Design,” in this chapter.

- **Wind loads.** – If no site-specific or regional wind data (using American Society of Civil Engineers [ASCE] 7 [43]) are available, a uniform horizontal load of 30 pounds per square foot per foot (lb/ft<sup>2</sup>/ft) (corresponding to an 86 mile-per-hour sustained wind) [37] on the exposed area of the spillway feature can be used. For usual loading combinations associated with stability evaluation, see Section 3.8.3, “Stability Design,” in this chapter. In this combination, the wind load may apply if there are high-profile (exposed) spillway features. Wind loads may also apply for unusual loading combinations associated with stability evaluation, see Section 3.8.3, “Stability Design,” in this chapter. For this combination, the wind load may apply during construction and prior to backfilling spillway features. For structural design methods, see Section 3.8.4, “Reinforced Concrete Design,” in this chapter.
- **Silt loads.** – Silt loads will typically not apply to most spillways. However, for some situations where there could be a submerged control structure, silt loads could come into play. If no site-specific data are available, an equivalent fluid horizontal pressure of 85 lb/ft<sup>2</sup>/ft and a vertical pressure of 120 lb/ft<sup>2</sup>/ft can be used [37]. Note that the pressure magnitude varies with depth, and the values include the effects of water within the silt.
- **Earthfill loads.** – For lateral loads, both active and at-rest conditions may apply, or depending on direction of movement, passive conditions may apply. In general, for relatively thin walls, such as those associated with an inlet structure or chute where adjacent fill has not been compacted,

---

<sup>44</sup> Free-draining fill will typically be pervious backfill, which is similar to embankment zones of sands and gravels. Pervious backfill is selected materials, reasonably well graded to 3-inch minus when adjacent to structures and 5- to 6-inch maximum size (except with occasional fragments larger than 5 to 6 inches) when not adjacent to structures. Also, pervious backfill shall not contain more than 5 percent fines (material passing the standard No. 200 sieve).

there may be sufficient deflection that the active soil wedge will form. However, for more rigid walls or features, such as those associated with a control structure, conduit, and terminal structure, and/or where adjacent fill has been compacted, at-rest lateral loading should be considered. As a general guideline, minimum movement of the wall at the top of fill is related to various design pressures and summarized by the following bullets [44]:

- **Active pressure.** – For loose (uncompacted) fill, minimum movement is  $0.002H$ ; for dense (compacted) fill, minimum movement is  $0.0005H$  (where  $H$  is depth of fill adjacent to the wall).
- **Passive pressure.** - More movement than cited for active conditions. For loose (uncompacted) fill, minimum movement is  $0.006H$ ; for dense (compacted) fill, minimum movement is  $0.002H$ .
- **At-rest pressure.** – Less movement than the above movement cited for active conditions.

Note that once walls are deflected, they will remain deflected unless the walls can overcome passive pressure.

Consult with involved geotechnical engineers to develop assumed values if site data are not available. If this is not possible, and there are no site-specific data, equivalent lateral pressures of  $40 \text{ lb/ft}^2/\text{ft}$  for pervious backfill and  $43 \text{ lb/ft}^2/\text{ft}$  for embankment materials (dry soil), and  $85 \text{ lb/ft}^2/\text{ft}$  (saturated soil) can be used (if active pressure conditions apply) [37]. Additionally, unit weights of  $120 \text{ lb/ft}^3$  for pervious backfill and  $130 \text{ lb/ft}^3$  for embankment materials (dry soil), and  $135 \text{ lb/ft}^3$  (saturated soil) can be used as default values. Note that the pressure magnitude varies with depth. Where site-specific data are available, the total lateral soil pressure (based on Mohr-Coulomb considerations) can be estimated. For usual, unusual, and extreme loading combinations associated with stability evaluation, see Section 3.8.3, “Stability Design,” in this chapter. For seismic loading considerations and structural design methods, see Sections 3.8.2, “Seismic (Earthquake) Loads,” and Section 3.8.4, “Reinforced Concrete Design,” in this chapter.

- **Construction loads.** – A construction load is temporary and should be treated as a surcharge load. These loads may be caused by construction equipment moving adjacent to a spillway wall, adjacent to or over a conduit, or the storage of construction materials on fill adjacent to a wall. If no site-specific data are available, an approximate equivalent horizontal and vertical uniform surcharge load of  $133 \text{ lb/ft}^2/\text{ft}$  and  $400 \text{ lb/ft}^2/\text{ft}$ , respectively, can be used. Although this approximate construction load can be used for preliminary or planning-level designs, construction loads

## Design Standards No. 14: Appurtenant Structures for Dams (Spillways and Outlet Works)

for final designs should be based on anticipated equipment moving or placed adjacent to the spillway structure. For unusual loading combinations associated with stability evaluation, see Section 3.8.3, “Stability Design,” in this chapter. For structural design methods, see Section 3.8.4, “Reinforced Concrete Design,” in this chapter.

- **Earthquake loads.** – Refer to Sections 3.8.3, “Seismic (Earthquake) Loads,” in this chapter, for selecting the seismic design load(s). Both pseudo-static and dynamic analysis methods may be employed to estimate the response of the structure to the earthquake loads. For extreme loading combinations associated with stability evaluation, see Section 3.8.3, “Stability Design,” in this chapter. For structural design methods, see Section 3.8.4, “Reinforced Concrete Design,” in this chapter.

### 3.8.2 Seismic (Earthquake) Loads

As a guideline, the initial design earthquake loading conditions for spillways include:

- **For noncritical<sup>45</sup> features and/or components**, the design basis earthquake (DBE) is assumed as the initial loading condition. The DBE is defined as a seismic event that has a 90-percent probability of nonexceedance in a 50-year timeframe, or a return period of about 500 years.
- **For critical<sup>46</sup> features and/or components**, the 10,000-year earthquake is generally assumed as the initial loading condition. This return period is based on Reclamation’s public protection guidelines of an annualized failure probability of less than 1E-4 [46]. The final seismic loading generally will not exceed the 50,000-year earthquake and will be dependent on downstream consequences typically evaluated in a risk analysis.

These initial assumed seismic loading conditions may or may not be adequate in terms of reducing or maintaining total risks at acceptable levels. Using the process outlined in Table 3.3.2-1, “Procedure for spillway design using quantitative risk analysis methodology,” in this chapter, more remote seismic return periods may be needed.

---

<sup>45</sup> A noncritical feature is one that could become damaged or fail without leading to damage and/or failure of the dam and without inhibiting spillway releases to protect the dam [45]

<sup>46</sup> A critical feature is one in which damage or failure could lead to damage and/or failure of the dam and/or other appurtenant features. Failure may result in uncontrolled releases of the reservoir and/or generate unacceptable downstream hazards. Additionally, failure could also result in an inoperable structure that is unable to make releases to protect the dam against failure [45].

To determine the appropriate seismic loads for a spillway, identification and evaluation of seismic-induced credible PFMs are undertaken (for more details, see Appendix B, “Potential Failure Modes (PFMs) for Spillways,” in this chapter). If there are seismic-induced credible PFMs, the design load is determined through the process outlined in table 3.3.2-1. This process begins with assuming initial design loading conditions.

Analytical tools used to estimate the response of the structure to the earthquake loads involve pseudo-static and dynamic methods. These include:

- **Pseudo-static methods.** – These methods are typically used during appraisal and feasibility design. On occasion, these methods may be used during final design when dealing with common, simple structures without complex soil-structure interactions and that are subject to small to moderate seismic loading. These pseudo-static methods include:
  - **Westergaard method.** – The Westergaard method estimates hydrodynamic loading. For more details about applying the Westergaard method, see Chapter 6, “Structural Design Considerations for Spillways and Outlet Works,” in this design standard.
  - **Mononobe-Okabe method.** – The Mononobe-Okabe (M-O) method estimates dynamic lateral soil loading. The M-O method computes the net static and dynamic force acting on a flexible (yielding) structure. For positive horizontal accelerations (soil accelerates toward the wall), the net dynamic active force ( $P_{AE}$ ) is greater than the net static active force ( $P_a$ ), and the net dynamic passive force ( $P_{PE}$ ) is less than the net static passive force ( $P_p$ ). Thus, compared with static conditions, the seismic earth pressures increase from the driving side soil mass and decrease from the resisting side soil mass. A limitation of the M-O method in higher seismic regions is that the soil angle of internal friction ( $\phi$ )<sup>47</sup> must be greater than the seismic inertial angle ( $\psi$ )<sup>48</sup>, which is a function of the horizontal acceleration. The M-O equations yield negative radicals (complex numbers) under such large seismic accelerations. A summary of the fundamental M-O assumptions is presented below:

<sup>47</sup> Soil angle of internal friction for a given soil is the angle determined from a Mohr’s Circle of the shear stress and normal effective stresses at which shear failure occurs.

<sup>48</sup> Seismic inertial angle is a function of the horizontal and vertical acceleration coefficients typically expressed as the arc-tangent of the horizontal acceleration coefficient over one minus the vertical acceleration coefficient.

**Design Standards No. 14: Appurtenant Structures for Dams  
(Spillways and Outlet Works)**

- The wall yields sufficiently when subjected to active pressures.
- The backfill is cohesionless.
- The soil is assumed to satisfy the Mohr-Coulomb failure criterion.
- When the minimum active pressure is attained, a soil wedge behind the wall is at the point of incipient failure, and the maximum shear strength is mobilized along the potential slip plane.
- Failure in the backfill occurs along a slip plane surface that is inclined at some angle with respect to the horizontal backfill passing through the toe of the wall.
- The soil wedge behaves as a rigid body, and accelerations are constant throughout the mass.
- Equivalent static horizontal and vertical forces are applied at the center of gravity of the wedge and represent the earthquake forces.
- Liquefaction is not a consideration for the backfill.
- The backfill is completely above or completely below the water table, unless the ground surface is horizontal, in which case the backfill can be partially saturated.
- The ground surface is planar, not irregular or broken.
- Any surcharge is uniform and covers the entire soil surface.
- The soil angle of internal friction must be greater than the seismic inertial angle ( $\phi \geq \psi$ ).

For more details about applying the M-O method, see Chapter 23, “Seismic Failure of Spillway/Retaining Walls,” of the *Dam Safety Risk Analysis Best Practices Training Manual* [6] and Chapter 6, “Structural Design Considerations for Spillways and Outlet Works,” in this design standard.

- **Woods method.** – The Woods method estimates dynamic lateral soil loading (only applicable for nonyielding wall conditions). Woods method is based on linear elastic theory and on idealized representations of the wall-soil structural system. Elastic methods were originally developed and applied for the design of basement walls that would be expected to experience very small displacements

under seismic loading and, as such, can be considered as rigid, nonyielding walls. The fundamental assumption for the elastic methods is that the relative soil-structure displacement generates soil stresses in the elastic range of the material. Elastic methods are usually based on elastic wave solutions and are thought to represent upper-bound dynamic earth pressures and, as a result, produce seismic loads greater than those of the M-O method. Wood's method predicts a total dynamic thrust acting at a height equal to approximately  $0.58H$  above the base of the wall. A summary of the fundamental Woods assumptions is presented below:

- The wall is a rigid, non-yielding wall.
- Soil stresses are in the elastic range.
- Computed dynamic thrust loads must be added to static lateral earth loads.
- Computed dynamic thrust loads are a function of the soil Poisson's ratio.
- Computed dynamic thrust loads are a function of the ratio of the effective horizontal length of the backfill to the height of the backfill.
- Not limited for large seismic accelerations.
- The earthquake shaking frequency is much less than the fundamental frequency of the backfill.

For more details about applying Woods method, see Chapter 23, "Seismic Failure of Spillway/Retaining Walls," of the *Dam Safety Risk Analysis Best Practices Training Manual* [6] and Chapter 6, "Structural Design Considerations for Spillways and Outlet Works," in this design standard.

- **Self-weight inertia (added mass).** – Any pseudo-static analysis will include the inertia forces associated with earthquake-induced acceleration of the spillway structure or feature, such as a wall. For more details, see Chapter 6, "Structural Design Considerations for Spillways and Outlet Works," in this design standard.

**Dynamic methods.** – Linear and nonlinear two-dimensional and three-dimensional Finite Element Model (FEM) methods are typically employed for some feasibility designs and for some final design level efforts (not all high-level designs will require FEM methods). Also, these methods are

## Design Standards No. 14: Appurtenant Structures for Dams (Spillways and Outlet Works)

used for very large seismic loadings and complex soil-structure interactions. For more details about applying linear and nonlinear two-dimensional and three-dimensional FEM methods, see Chapter 23, “Seismic Failure of Spillway/Retaining Walls,” of the *Dam Safety Risk Analysis Best Practices Training Manual* [6] and Chapter 6, “Structural Design Considerations for Spillways and Outlet Works,” in this design standard.

### 3.8.3 Stability Design

A number of foundation and structural stability conditions must be evaluated during the analysis and/or design of a spillway. These conditions are grouped by loading combinations and are discussed in the following sections.

#### 3.8.3.1 Loading Combinations

Loading combinations for spillway stability design typically are grouped into three categories, including:

- **Usual (normal or service) loading combination.** – Loading conditions include the maximum normal RWS, with appropriate dead loads, uplift, silt, ice, and tailwater. Foundation and structural stability should be evaluated for this loading combination, which is further discussed in Section 3.8.3.2, “Stability Conditions,” in this chapter.
- **Unusual loading combination.** – Loading conditions include the flood-induced maximum design RWS, with appropriate dead loads, uplift, silt, and tailwater. (Note: In some cases, these loading conditions have been evaluated as an extreme loading combination primarily when the maximum design flood event is associated with an extremely remote event, such as the PMF). A variation of the loading combination is to assume that the drainage system is inoperable and evaluate this with full uplift. Foundation and structural stability should be evaluated for this loading combination, which is further discussed in Section 3.8.3.2, “Stability Conditions,” in this chapter.
- **Extreme loading combination.** – Loading conditions include maximum normal RWS, with appropriate dead loads, uplift, silt, ice<sup>49</sup>, and tailwater, plus earthquake loadings. Foundation and structural stability should be evaluated for this loading combination, which is further discussed in Section 3.8.3.2, “Stability Conditions,” in this chapter.

---

<sup>49</sup> Ice loads would be included if present for a significant part of the winter. Ice loads would not be included if limited to days to several weeks.

### 3.8.3.2 Stability Conditions

As previously noted, stability conditions are evaluated and the methods used are summarized by the following bullets.

- Overturning displacement (failure)** occurs when a structural feature (such as a wall) rotates about an axis point (such as the end base point of the wall) or the sum of the overturning (destabilizing) moments about the end base point of the wall exceed the sum of the resisting (stabilizing) moments about the end base point of a wall [44]. Spillway features typically evaluated for overturning displacement include: inlet structures with cantilever, gravity, and/or counterforted walls; control structures including towers (drop inlets), along with any control structure with cantilever, gravity, and/or counterforted walls; conveyance features, specifically chutes with cantilever, gravity, and/or counterforted walls; and terminal structures with cantilever, gravity, and/or counterforted walls. Of note, if the resultant of all forces acting on the feature falls within the middle third of the base of the feature, adequate safety against overturning exists. The governing equation is:

$$SF_{OVERTURNING} = \frac{\sum M_{RESISTING}}{\sum M_{OVERTURNING}}$$

Where:  $SF_{OVERTURNING}$  is the safety factor (see Table 3.8.3.2-1, “Minimum safety factors,” which appears later in this document).

$\sum M_{RESISTING}$  is sum of (total) resisting moments about designated tipping point (such as the toe of a retaining wall, and can include the effects of anchor bars, and/or rock bolts (ft-lb).

$\sum M_{OVERTURNING}$  is sum of (total) overturning moments about designated tipping point (such as the toe of a retaining wall) (ft-lb).

- Sliding displacement (failure)** occurs when a structural feature (such as gated control structure) slides along the contact with the foundation, and the adjacent foundation slides along joints and/or zones of weakness within the foundation. Sliding occurs when the sum of the driving forces exceeds the sum of the resisting forces (shear strength of the foundation contact and/or foundation) [44]. Spillway features typically evaluated for sliding displacement include: inlet structures; control structures; conveyance features, specifically chutes; and terminal structures. The governing equation is:



**Design Standards No. 14: Appurtenant Structures for Dams  
(Spillways and Outlet Works)**

$$SF_{SLIDING} = \frac{CA + (\sum N + \sum U) \tan \phi}{\sum V}$$

Where:  $SF_{SLIDING}$  is the safety factor (see Table 3.8.3-1, “Minimum safety factors”).

$C$  is cohesion at the interface between the structure and foundation (lb/ft<sup>2</sup>).

$A$  is the contact area of the interface between the structure and foundation (ft<sup>2</sup>)

$\sum N$  is sum of the normal forces acting on the interface between the structure and foundation (lb).

$\sum U$  is sum of the uplift forces acting on the interface between the structure and foundation (designated as negative values) (lb).

$\tan \phi$  is coefficient of internal friction associated with the interface between the structure and foundation

$\sum V$  is sum of the shear forces acting on the interface between the structure and foundation (lb).

- **Bearing capacity displacement (failure)** occurs when the bearing pressure of the spillway feature (such as a drop inlet control structure) exceeds the ultimate bearing capacity (shear strength) associated with its foundation (rock or soil). If site-specific data are not available, consultation with involved geotechnical engineers and/or geologists may be warranted. Also, an initial assumption can be made that the allowable bearing pressure is one-half (for soil foundation) to one-quarter (for rock foundation) of the ultimate bearing capacity [44]. Spillway features typically evaluated for bearing capacity displacement include: inlet structures; control structures; conveyance features, specifically chutes; and terminal structures. The governing equation is:

$$SF_{BEARING} = \frac{P_{ULTIMATE}}{P_{CALCULATED}}$$

Where:  $SF_{BEARING}$  is the computed safety factor that must be greater than the required minimum safety factor (see Table 3.8.3.2-1, “Minimum safety factors”).

$P_{ALLOWABLE}$  is the maximum allowable pressure permitted for a given foundation (this will be a percentage of the ultimate bearing capacity of the foundation -  $P_{ULTIMATE}$ ) (lb/ft<sup>2</sup>).

$P_{CALCULATED}$  is the calculated pressure acting on a given foundation (lb/ft<sup>2</sup>).

$P_{ULTIMATE}$  is the maximum pressure that a foundation can sustain without exceeding the shear strength of the foundation (lb/ft<sup>2</sup>).

- **Floatation displacement (failure)** occurs when the vertical load (weight) of the spillway feature (such as a stilling basin which has been isolated from the tailwater by stoplogs and unwatered or when a stilling basin sweepout occurs (i.e., the hydraulic jump is pushed downstream of the stilling basin) is exceeded by buoyant forces (such as the uplift due to tailwater around the spillway feature). Spillway features typically evaluated for floatation displacement include: isolated and unwatered control structures; isolated and unwatered conveyance features, specifically conduits; isolated and unwatered terminal structures; and during operation with the minimum depth of flow ( $d_1$ ) entering the stilling basin (upstream of the hydraulic jump) and the conjugate depth of flow ( $d_2$ ) exiting the stilling basin (downstream of the hydraulic jump). Of note, safety factors for floatation are typically calculated assuming that drains are not functioning and anchor bars are not considered. The governing equation is:

$$SF_{FLOATATION} = \frac{\sum L}{\sum U}$$

Where:  $SF_{FLOATATION}$  is the computed safety factor that must be greater than the required minimum safety factor (see Table 3.8.3.2-1, “Minimum safety factors”).

$\sum L$  is the sum of (total) vertical forces acting on the interface between the structure and foundation (lb).

$\sum U$  is the sum of the uplift forces acting on the interface between the structure and foundation (lb).

**Design Standards No. 14: Appurtenant Structures for Dams  
(Spillways and Outlet Works)**

**Table 3.8.3.2-1. Minimum safety factors**

<b>Stability conditions</b>	<b>Load combinations</b>	<b>Minimum safety factors</b>
Overturning <sup>1</sup>	Usual (normal)	1.5*
	Unusual	1.15*
	Extreme	1.15*
Sliding	Usual (normal)	1.5*
	Unusual	1.15*
	Extreme	1.15*
Bearing capacity	Usual (normal) – soil	2.0*
	Usual (normal) – rock	4.0*
	Unusual - soil	1.5*
	Unusual - rock	3.0*
	Extreme – soil	1.5*
	Extreme - rock	3.0*
Floatation	Usual (normal)	1.2**
	Unusual	1.1**
	Extreme	1.1**

<sup>1</sup> Low overturning safety factors are likely to be an indicator that other types of instability can occur, such as bearing capacity or sliding due to shearing at the base of the structure. This is because of rotating a structure about a point that will result in high stress concentrations in the structure and/or foundation.

\* Reference: Design Criteria for Concrete Retaining Walls [44]

\*\* Reference: Chapter 2, “Structural Design, Data and Criteria,” in Design Standards No. 9.

Minimum safety factors have been established and are associated with loading combinations (see Section 3.8.3.1, “Loading Combination,” in this chapter). Note that higher safety factors for both new and existing spillways may be required to meet Reclamation’s quantitative risk analysis guidelines. The safety factors are summarized in table 3.8.3.2-1.

Again, it is stressed that these are minimum (default) safety factors, which may need to be increased to achieve acceptable risk levels associated with Table 3.3.2.1-1, “Procedures for spillway design using quantitative risk analysis methodology.”

### **3.8.4 Reinforced Concrete Design**

Reclamation has been designing concrete structures for over 100 years, and many changes and advancements have occurred. One of the more significant design changes has been the shift from the Alternate Design (Working Stress Design) Method<sup>50</sup> to Strength Design Method.<sup>51</sup> Current Reclamation reinforced concrete

<sup>50</sup> For the Alternate Design Method, a structural element is designed so that stresses from service loads do not exceed allowable values. Stresses computed by this method will be within the

design methodology employs the ACI building codes as a minimum, with application of these building codes documented in the *Reinforced Concrete Design and Analysis Guidelines* [49]. For most hydraulic structures such as spillways, ACI 350-06 (*ACI Code Requirements for Environmental Engineering*) [48] is used to establish minimum reinforced concrete design levels. For significant- and high-hazard storage and multipurpose dams and their appurtenant structures (such as spillways), a risk-based evaluation, analysis, and/or design will typically be needed, resulting in designs equal to or exceeding the applicable ACI building codes. Applying risk methodology to evaluation, analysis, and/or design associated with modifying an existing spillway or constructing a new spillway is outlined in Table 3.3.2-1, “Procedure for spillway design using quantitative risk analysis methodology” in this chapter and further discussed in various chapters of Reclamation’s *Dam Safety Risk Analysis Best Practices Training Manual* [6].

A brief overview of reinforced concrete design is discussed in the following paragraphs.

### 3.8.4.1 Strength Design

This design approach is based on the fundamental concept that structures and structural members shall be designed to have design strengths at all sections at least equal to the required strengths calculated for the factored loads and forces in such combinations as stipulated in ASCE 7, *Minimum Design Loads for Buildings and Other Structures* [43] and ACI 318, *Building Code Requirement for Structural Concrete and Commentary* [49]. This basic requirement for strength design can be expressed as:

$$\text{Design Strength} \geq \text{Required Strength}$$

The design strength provided by a member in terms of flexure, axial load, shear, and torsion is taken as the nominal strength determined in accordance with the requirements and assumptions of ACI 318, *Building Code Requirement for Structural Concrete and Commentary* multiplied by the appropriate strength reduction factors ( $\phi$ ) presented in the same code [49]. This is expressed as:

$$\text{Design Strength} = \phi (\text{Nominal Strength})$$

---

elastic range, and straight-line variation between stress and strain is used. As of 2002, this method has been eliminated from the ACI building codes.

<sup>51</sup> For the Strength Design Method, the service loads are increased by load factors to obtain the ultimate design load. The structural element is then designed to provide the desired ultimate design strength. The method takes into account the nonlinear stress-strain behavior of concrete.

## Design Standards No. 14: Appurtenant Structures for Dams (Spillways and Outlet Works)

The required strength ( $U$ ) is expressed in terms of combinations of factored loads, or related internal moments and forces. Factored loads are applicable loads specified in general building codes, such as ASCE 7 [43], multiplied by appropriate load factors ( $LF$ ). This is expressed as:

$$\text{Required Strength } (U) = LF (\text{Load})$$

In strength design, the margin of safety is provided by the combined effects of multiplying the computed service loads by the appropriate load factor and multiplying nominal (expected) strength by a strength reduction factor.

### 3.8.4.2 Loads

The loads that are generally considered for the purpose of designing spillway structures may include, but are not limited to:

- Permanent loads:
  - $D$  = dead loads from structural and mechanical components
  - $F$  = vertical load from weight of soil or water
  - $H$  = static lateral earth pressure (including surcharge) and lateral water pressure loads
- Transient loads:
  - $E$  = Earthquake loads
  - $S$  = Snow/Ice loads
  - $L$  = Live loads
  - $T$  = Temperature loads
  - $W$  = Wind loads

For more information about loads, refer to Section 3.8.1, “Loading Conditions,” in this chapter.

### 3.8.4.3 Load Combinations

The load combinations associated with load factors for strength design are provided in chapter 2 of ASCE 7 [43]. Load factors are assigned by structural code based on the degree of accuracy to which the load effect can be calculated and the variation that might be expected in the load during the lifetime of the structure. Load factors also account for the variability in the structural analysis used to compute moments and shears.

#### 3.8.4.4 Load Factors

Typical load combinations used for the design of spillways are presented below; however, the designer must refer to chapter 2 of ASCE 7 [43] to determine all appropriate load combinations and load factors:

$$U = 1.4 (D+F)$$

$$U = 1.2 (D+F+T) + 1.6 (L+H) + 0.5S$$

$$U = 1.2D + 1.6S + (L \text{ or } 0.8W)$$

$$U = 1.2D + 1.6W + L + 0.5S$$

$$U = 1.2D + 1.0E + L + 0.2S$$

$$U = 0.9D + 1.6W + 1.6H$$

$$U = 0.9D + 1.0E + 1.6H$$

Seismic load factors need special consideration for Reclamation designs. Specifically, earthquake loads are determined based on risk-based studies and, as such, seismic load factors should be determined relative to the level of seismic design established on a project-by-project basis.

#### 3.8.4.5 Strength Reduction Factors ( $\phi$ )

These factors for reinforced concrete strength design are provided in section 9.3 of ACI 318 [49]. The purpose of strength reduction factors is to allow for the probability of under-strength members, due to variations in material strengths and dimensions, to allow for inaccuracies in design equations, to reflect the degree of ductility, to reflect the required reliability of the member under load effects being considered, and to reflect the importance of the member in the structure. Strength reduction factors provided in ACI 318, section 9.3 [49] include:

$$\phi_{tens} = 0.9 \text{ for tension controlled sections}$$

$$\phi_{comp} = 0.65 \text{ for compression controlled sections}$$

$$\phi_{spiral} = 0.75 \text{ for compression controlled sections with adequate spiral reinforcement}$$

$$\phi_{shear} = 0.75 \text{ for shear}$$

$$\phi_{torsion} = 0.75 \text{ for torsion}$$

**Design Standards No. 14: Appurtenant Structures for Dams  
(Spillways and Outlet Works)**

**3.8.4.6 Serviceability Considerations for Hydraulic Structures**

Hydraulic structures, such as spillways, have unique serviceability requirements that need to be considered as part of their design. Specifically, spillway structures are expected to be durable structures with a design life in excess of 50 years. Their ability to perform as designed under unusual flood conditions is paramount to the overall safety of the dam. In addition, they are often subjected to harsh environments including extreme temperature variations and severe wet and dry cycles. As such, an environmental durability coefficient in accordance with ACI 350 [48] is used for concrete strength design. The environmental durability factor is also known as a hydraulic factor ( $H_f$ ) in accordance with ASCE design criteria for hydraulic structures [50]. Specifically, all load factors listed in Section 3.8.4.4, “Load Factors,” in this chapter are multiplied by an  $H_f$  value of 1.3 to limit the extent and width of concrete cracks and to provide additional durability throughout the design life of the structure. In equation form, the modified load factor for design of reinforced concrete hydraulic structures is as follows:

$$U_h = 1.3U$$

Where:  $U_h$  is the modified hydraulic load factor  
 $U$  is the applicable load factor

**3.8.4.7 New Concrete and Reinforcement Properties**

In the absence of laboratory testing data and site-specific design data, the following concrete material properties can be used for reinforced concrete design of a new spillway or for modifications to an existing spillway:

- Compressive strength at 28 days ( $f_c'$ ) = 4,500 lb/in<sup>2</sup> ( $f_c'$  is based on ACI 318 [49] or 350 [48] exposure category F1, F2, and F3, where concrete is exposed to moisture and cycles of freezing and thawing).
- Tensile strength ( $f_t$ ) = 0.04 to 0.06  $f_c'$ .
- Shear strength:
  - Cohesion ( $c$ ) = 0.1  $f_c'$ .
  - Coefficient of internal friction ( $\tan\phi$ ) = 1.0.
- Sustained (static) modulus of elasticity ( $E_s$ ) = 4.1E6 lb/in<sup>2</sup>.
- Coefficient of thermal expansion ( $\alpha$ ) = 5.0E-6 °F.

- Poisson's ratio ( $\mu$ ) = 0.20.
- Unit weight ( $\gamma_c$ ) = 150 lb/ft<sup>3</sup>.

Also, all reinforcing bars will have a yield strength ( $f_y$ ) of 60,000 lb/in<sup>2</sup>. Furthermore, with few exceptions, using corrosion protection<sup>52</sup>, such as epoxy-coated reinforcing bars, is not standard practice.

### 3.8.4.8 Existing Concrete and Reinforcement Properties

A consideration that should not be overlooked when dealing with modifying existing structures is determining the material properties and design methods used for an existing spillway. Ideally, there are existing technical references that document the original material properties and design methods, or field testing will be done to determine the existing material properties. However, in some cases where technical information is not available, engineering judgment must be employed, which can be supported by a good understanding of the evolution of concrete and reinforcement during the last century. An approach used by Reclamation is based on the existing spillway's time of construction, using information found in Chapter 6, "Structural Considerations for Spillways and Outlet Works," in this design standard, and other references [52] to identify likely concrete material properties and reinforcing bar yield strength and sizes for that period. As an example, reinforcement embedment and splice lengths in older concrete structures may not be adequate to develop the full strength of the reinforcing bars, thus limiting the effectiveness of the reinforcement in critical (high stress) areas of the structure. Note that reasonable ranges of concrete material properties and reinforcing bar data should be used in a parametric (sensitivity) evaluation, to reflect potential concrete strength gain (or loss) over time and potential variation in reinforcing steel properties. The results of this parametric evaluation would be incorporated into the overall modification design of the spillway.

### 3.8.5 Reinforcement

The sizing and layout of reinforcement is an important design activity, and the level of effort will be influenced by the approach used to portray reinforcement. One of two reinforced structural specifications drawing formats will apply [51]:

- **Typical sections and window drawings.** – Applicable to simple structures (such as a grade control sill or a small chute or retaining wall) and may be included as part of the outline drawings. This type of reinforcement detailing must be sufficient to bid, inspect, and construct

---

<sup>52</sup> Adequate corrosion protection can typically be achieved by encasing the reinforcing bars in concrete. Additional corrosion protection such as cathodic protection or epoxy-coated reinforcing bars seldom has been considered given any additional benefits versus cost.



## **Design Standards No. 14: Appurtenant Structures for Dams (Spillways and Outlet Works)**

the structure without further information. Typical placement patterns of reinforcement are shown in “windows” with reinforcing bar size and spacing indicated (not all reinforcing bars are shown).

- **Detailed concrete reinforcement design drawings.** – Applicable to most features (such as control structures, chutes, conduits, tunnel lining, and terminal structures) that are not considered simple structures. These are typically separate drawings from the outline drawings. These drawings show reinforcing bars in at least two views (plan, profile, section, and/or details) and define true length, shape, size, number, and location, along with sufficient detail for the contractor to determine the placement patterns of reinforcement. This also allows construction management staff to determine if the reinforcement placement patterns meet the design intent.

Guidelines concerning reinforcement layout can be found in *ACI Detailing Manual-2004* (SP-66) [53]. Also, the reader is directed to Technical Memorandum TSC-8100-Standards-2011-1 (Standard Drawing 40-D-6263 - Revision 8 – “Background and Development”) [54]. In addition to these references, other general design considerations are further discussed in the Working Document – GUI-8130-1, *Detailed Reinforcement Drawing Guidelines* [55], found in Chapter 6, “Structural Considerations for Spillways and Outlet Works,” in this design standard.

### **3.8.6 Joints, Waterstops, and Tolerances**

Design considerations involve identifying and locating joints and waterstops, along with specifying surface tolerances for reinforced concrete spillways, which are summarized in the following sections.

#### **3.8.6.1 Joints**

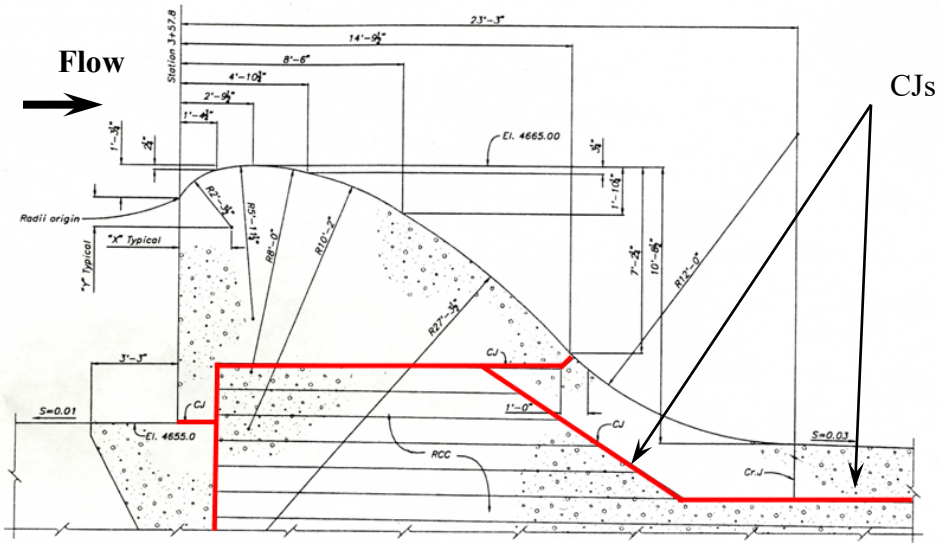
Identifying and locating joints for modified and new reinforced concrete spillways are important design considerations. Particularly for flow surfaces, proper detailing can mitigate the development of adverse hydraulic conditions such as stagnation pressure and/or cavitation potential. The majority of joints associated with a spillway include construction joints (CJ), contraction joints (CrJ), and control joints (CtJ). Additionally, on a limited basis, expansion joints (EJ) are used on some spillway features such as bridges and parapet walls. With some exceptions, these joints are oriented perpendicular and parallel to the spillway centerline (floor or slab joints) and vertical (wall joints). Further details concerning these joints are provided in the following sections. These sections include:

- **Construction joints**, see Section 3.8.6.1.1 in this chapter.
- **Contraction joints**, see Section 3.8.6.1.2 in this chapter.
- **Control joints**, see Section 3.8.6.1.3 in this chapter.
- **Surface delamination near CrJs and CtJs**, see Section 3.8.6.1.4 in this chapter.
- **Expansion joints**, see Section 3.8.6.1.5 in this chapter.
- **General guidelines for selecting joints**, see Section 3.8.6.1.6 in this chapter.

### **3.8.6.1.1 Construction Joints**

The CJs are chemically bonded surfaces or planes produced by placing fresh concrete against surfaces of clean hardened concrete. Reinforcement is continuous across CJs, and waterstops and keys are seldom used (see figure 3.8.6.1.1-1). The expectation is that CJs will be as strong as the concrete matrix (i.e., not create a plane of weakness). To ensure bonding, the joint surface of the existing concrete to be covered with fresh concrete should be clean, roughened, and SSD. For definition of SSD, refer to Section 3.7.2.1.4, “Cleanup,” in this chapter. This would include removing all laitance, loose or defective concrete, coatings, sand, curing compound, and other foreign materials. Sandblast, steel shotblast, high-pressure water jet, or other methods approved by Reclamation may be used to create acceptable surfaces. The location and spacing of the CJs are governed by the anticipated concrete placement capacity, concrete forming requirements, and requirements for second-stage concrete construction (such as installation of metal work in a blockout that is later filled with concrete). The CJs are also intended to reduce initial shrinkage stresses and cracks. The CJ locations are usually planned (located) as part of the design; however, they may also be added by the contractor to facilitate construction but must be approved by the designer of record. These joints are sometimes identified as optional construction joints (OCJs) when a CJ is not required but may be added by the contractor to facilitate construction. Some CJs may be required because of inadvertent and/or unanticipated delays (due to weather, equipment breakdown, etc.) in concrete placement. The CJ orientation is typically horizontal (separating one concrete placement from the next concrete placement, such as placing a spillway conduit arch section on the previously placed conduit base section). An exception is using CJs normal to the flow surface in tunnels. Vertical and/or diagonal orientation of a CJ can be satisfactorily achieved with appropriate levels

**Design Standards No. 14: Appurtenant Structures for Dams  
(Spillways and Outlet Works)**



Glendo Dam, Wyoming: section through new auxiliary spillway, which employs CJs at the interface between the RCC and the structural concrete



Glendo Dam, Wyoming: construction of new auxiliary spillway

**Figure 3.8.6.1.1-1. CJ orientation (horizontal, vertical, and diagonal).**

of care and oversight during construction. An example of horizontal, vertical, and diagonal CJs is associated with a reinforced concrete ogee crest control structure being placed on a RCC cutoff (see figure 3.8.6.1.1-1).

### **3.8.6.1.2 Contraction Joints**

The CrJs are unbonded surfaces separating adjacent concrete placements. Sealing and/or curing compounds or other bond breakers are placed against the existing concrete on the initially cast portion of concrete to prevent bonding with the concrete placed against it. Separation of adjacent concrete placements and/or structures is used to relieve tensile stresses and cracking induced by shrinkage. For longitudinal floor joints, CrJs are vertical and extend from the foundation to the top of the concrete placement. Transverse floor CrJs are normal (90 degrees) to the centerline of the spillway and normal to the slope of the flow surface. Transverse wall CrJs are normal (90 degrees) to the centerline of the spillway and vertical. For details of flow surface CrJs, see figures 3.8.6.1.2-1, 3.8.6.1.2-2, and 3.8.6.1.2-3.

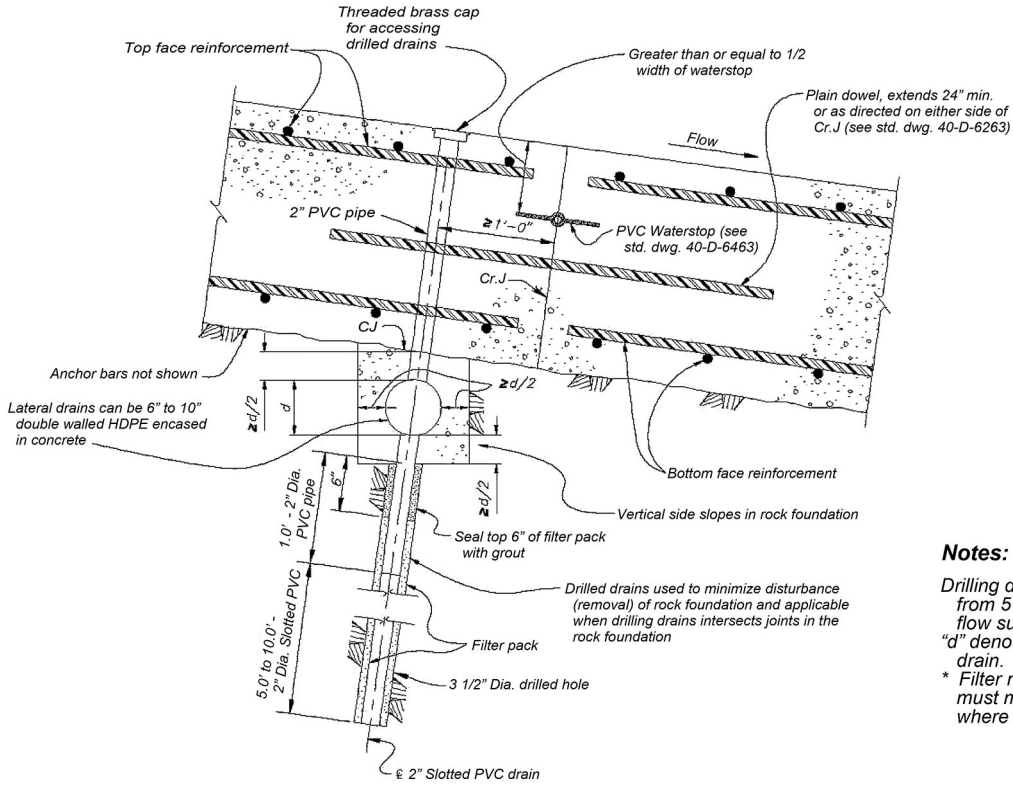
Reinforcement is not continuous across CrJs to prevent any moment transfer (floor CrJs are an exception, where plain reinforcing dowels may extend across the CrJs). With few exceptions, waterstops (see Section 3.8.6.2, “Waterstops,” in this chapter for more information, and refer to standard drawing 40-D-6463) are used for flow surface CrJs, and formed concrete keys across the CrJs may be employed (refer to standard drawing 40-D-5249)<sup>53</sup>.

The location and spacing of CrJs should be governed by the physical features of the spillway, temperature study results, concrete placement methods, and the potential concrete placing capacity. Also, foundation conditions (such as a transition from rock foundation to soil foundation) may be a factor in location of floor CrJs. Typical CrJ spacing ranges from 15 to 40 feet. It is highlighted that large spacing (typically greater than 20 feet) could be more susceptible to shrinkage cracking. When evaluating large spacing of joints, considerations should be given to undertaking concrete mix designs and temperature studies to evaluate cracking potential and joint spacing.

---

<sup>53</sup> Standard drawings are not included with this design standard due to the frequency of change. Typically standard drawings are reviewed and updated whenever the ACI building code is updated, which occurs more frequently than updating design standards. Reclamation staff can access standard drawings through the INTRANET. Non-Reclamation staff can request standard drawings.

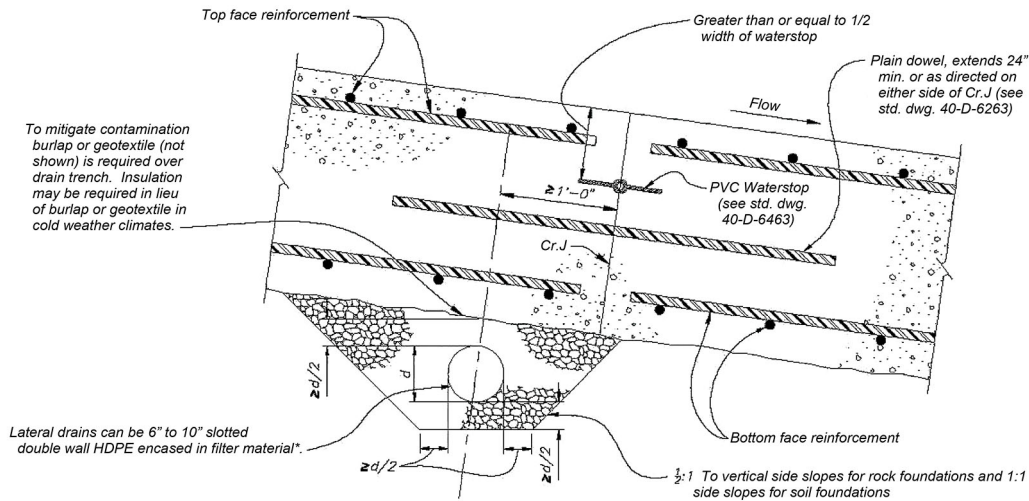
**Design Standards No. 14: Appurtenant Structures for Dams  
(Spillways and Outlet Works)**



**Notes:**

- Drilling drain spacing range from 5 to 10 feet between flow surface walls.
- "d" denotes diameter of HDPE drain.
- \* Filter material around drains must meet filter requirements where needed.

**CASE 1A: ROCK FOUNDATION WITHOUT FOUNDATION KEY – FLAT TO GRADUAL SLOPE – APPLICABLE FEATURE IS TERMINAL STRUCTURE (STILLING BASIN)**



**CASE 1B: ROCK OR SOIL FOUNDATION WITHOUT FOUNDATION KEY – FLAT TO GRADUAL SLOPE – APPLICABLE FEATURE IS TERMINAL STRUCTURE (STILLING BASIN)**

**Figure 3.8.6.1.2-1. Transverse CrJs without foundation keys for flow surface slabs.**

### Chapter 3: General Spillway Design Considerations

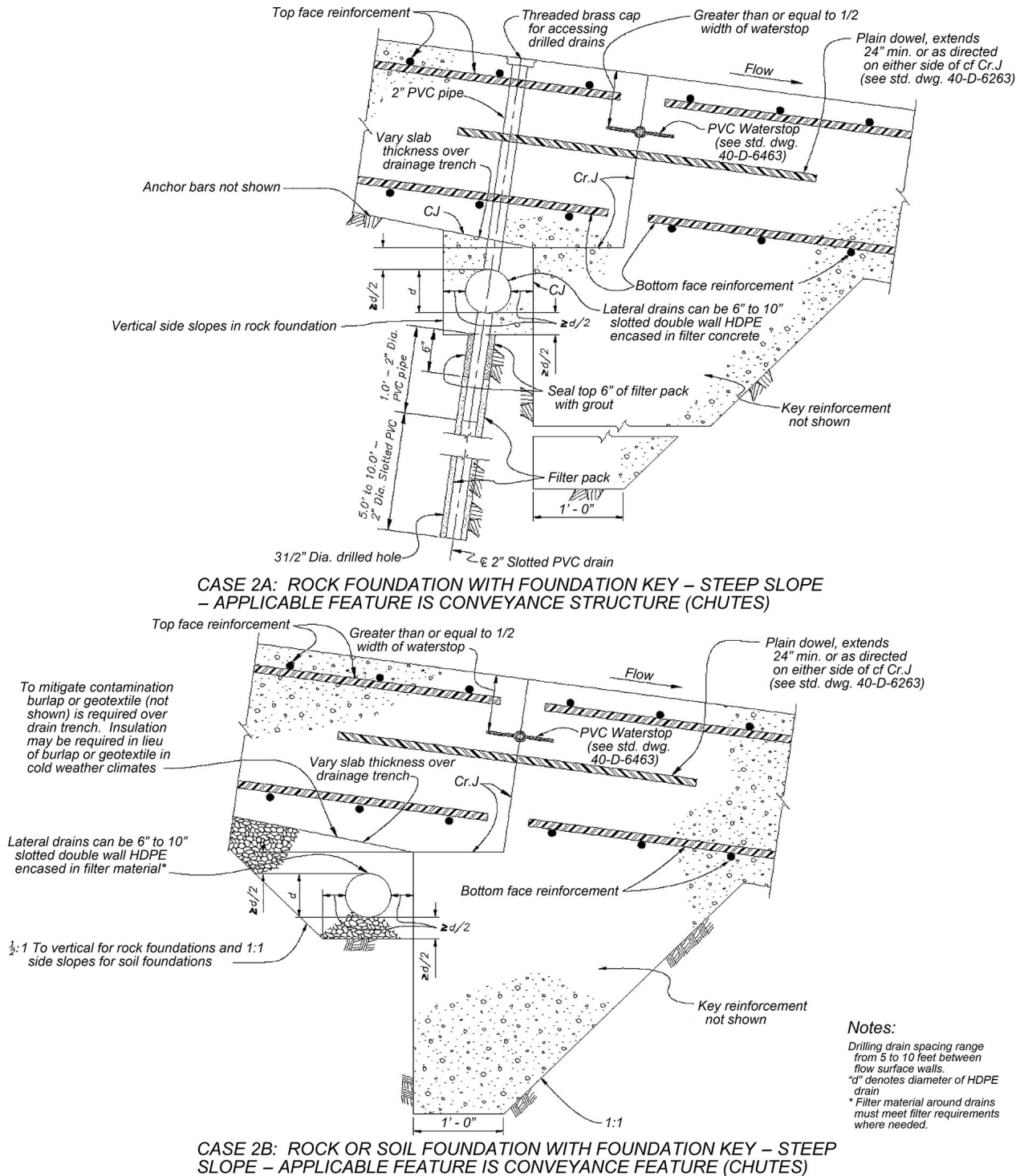
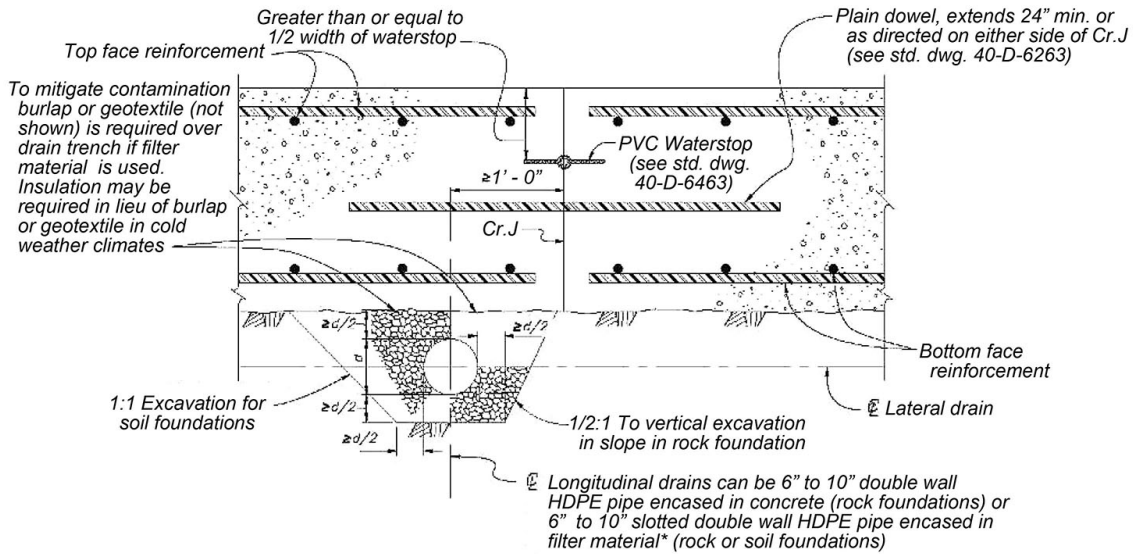


Figure 3.8.6.1.2-2. Transverse CrJs with foundation keys for flow surface slabs.



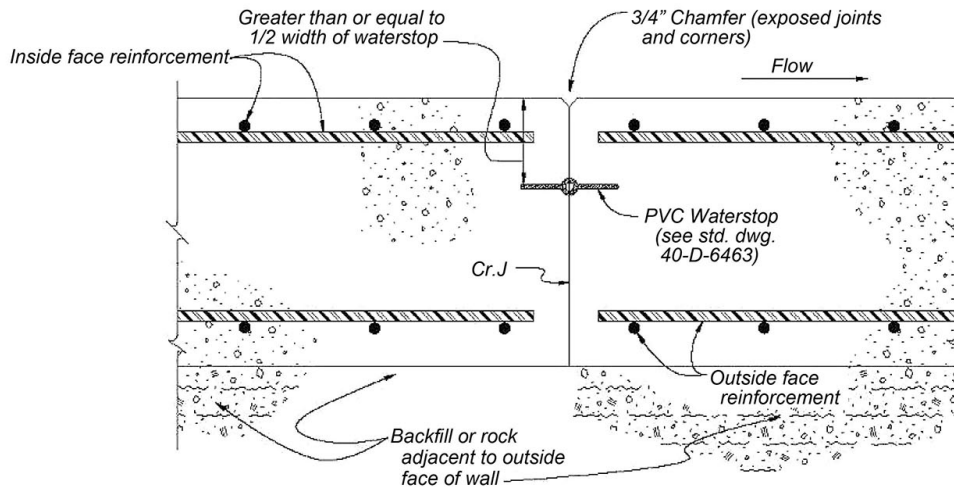
**Design Standards No. 14: Appurtenant Structures for Dams  
(Spillways and Outlet Works)**



**FLOW SURFACE SLAB – LONGITUDINAL CONTRACTION JOINT (Cr.J) ON ROCK OR SOIL FOUNDATION WITHOUT FOUNDATION KEY – APPLICABLE FEATURES ARE CONVEYANCE FEATURES (CHUTES) AND TERMINAL STRUCTURES (STILLING BASIN)**

**Notes:**

Drilling drain spacing range from 5 to 10 feet between flow surface walls.  
 "d" denotes diameter of HDPE drain.  
 \* Filter material around drains must meet filter requirements where needed.



**FLOW SURFACE WALL – LATERAL (TRANSVERSE) CONTRACTION JOINT (Cr.J) THRU WALL – APPLICABLE FEATURES ARE CONVEYANCE FEATURE (INLET STRUCTURE AND CHUTE), CONTROL STRUCTURE, AND TERMINAL STRUCTURE (STILLING BASIN)**

**Figure 3.8.6.1.2-3. Longitudinal CrJs for flow surface slabs and transverse CrJs for flow surface walls.**

### 3.8.6.1.3 Control Joints

The CtJs are unbonded surfaces separating adjacent concrete placements. Sealing and/or curing compound or other bond breakers are placed against the concrete on the initially cast portion of concrete to prevent bond with the concrete placed against it. Separation of adjacent concrete placements and/or structures is used to relieve tensile stresses and cracking induced by shrinkage. For longitudinal floor joints, CtJs are vertical and extend from the foundation to the top of the concrete placement. Transverse floor, conduit, and tunnel CtJs are normal (90 degrees) to the centerline of the spillway and normal to the slope of the flow surface. For details of flow surface CtJs, see figures 3.8.6.1.3-1, 3.8.6.1.3-2, and 3.8.6.1.3-3.

Reinforcement is continuous across CtJs to allow moment transfer and can facilitate the bridging of the concrete feature over localized differential movement (settlement) of the foundation. With few exceptions, waterstops (see Section 3.8.6.2, “Waterstops,” in this chapter for more information, and refer to standard drawing 40-D-6463) are used for flow surface joints, and formed concrete keys across the CtJs may be employed (refer to standard drawing 40-D-5249).

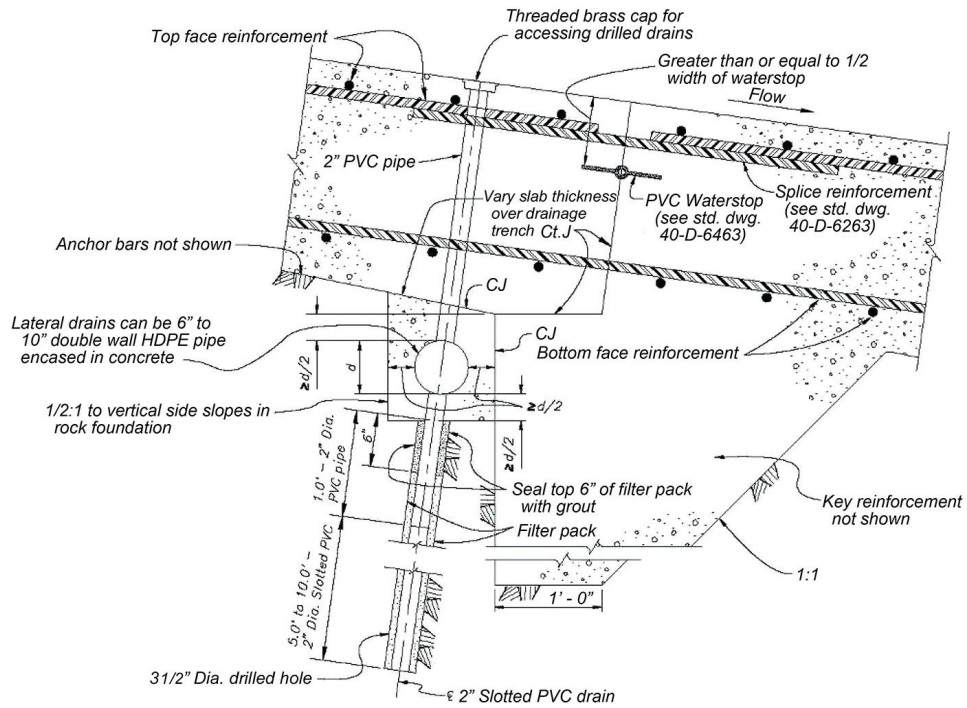
The location and spacing of CtJs should be governed by the physical features of the spillway, temperature study results, concrete placement methods, and the potential concrete placing capacity. Also, foundation conditions (such as a transition from rock foundation to soil foundation) may be a factor in location of floor CtJs. Typical CtJ spacing ranges from 15 to 40 feet. It is highlighted that large spacing (typically greater than 20 feet) could be more susceptible to shrinkage cracking. When evaluating large spacing of joints, considerations should be given to undertaking concrete mix designs and temperature studies to evaluate cracking potential and joint spacing.

For closely spaced reinforcement, a different splice detail for the top face has been used to reduce the chance of delamination at the joint (see Section 3.8.6.1.4, “Surface Delaminations Near CrJs and CtJs,” in this chapter). Instead of locating the splice in the same plane as the reinforcement pattern (and potentially introducing a plane of weakness), the reinforcing bars are stopped on each side of the joint, and a single splice bar is placed below the reinforcement that splices to each bar on either side of the CtJ. This detail can be seen in figures 3.8.6.1.3-1, 3.8.6.1.3-2, and 3.8.6.1.3-3.

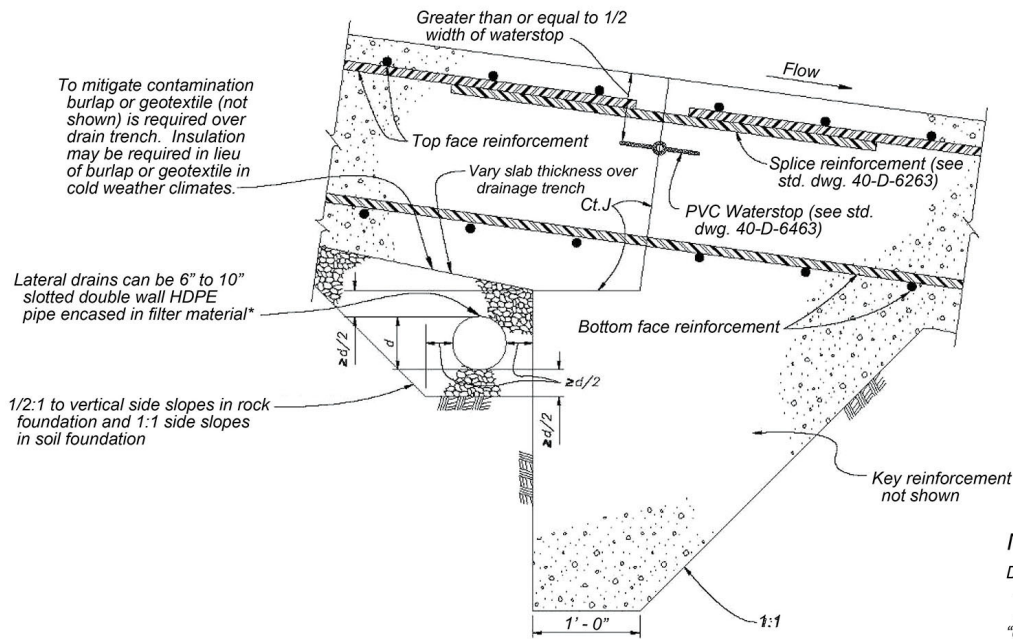




### Chapter 3: General Spillway Design Considerations



CASE 2A: LATERAL (TRANSVERSE) CONTROL JOINT (Ct.J) ON ROCK FOUNDATION WITH FOUNDATION KEY – STEEP SLOPE – APPLICABLE FEATURE IS CONVEYANCE FEATURE (CHUTE)



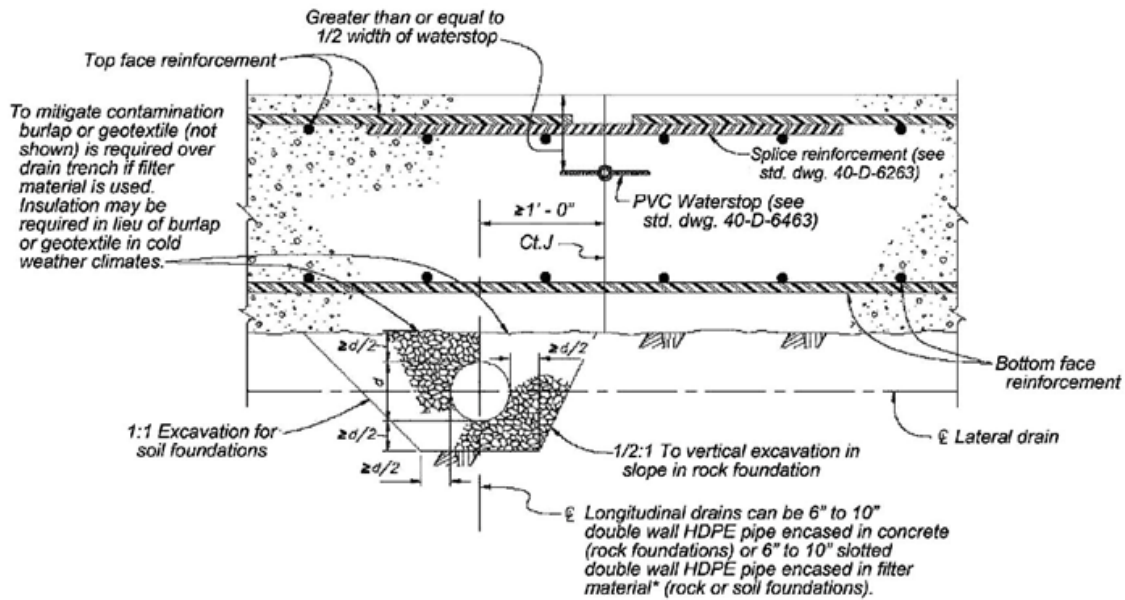
CASE 2B: ROCK OR SOIL FOUNDATION WITH FOUNDATION KEY – STEEP SLOPE – APPLICABLE FEATURE IS CONVEYANCE FEATURE (CHUTE)

**Notes:**

- Drilling drain spacing range from 5 to 10 feet between flow surface walls.
- "d" denotes diameter of HDPE drain
- \* Filter material around drains must meet filter requirements where needed.

Figure 3.8.6.1.3-2. Transverse CtJs with foundation keys for flow surface slabs.

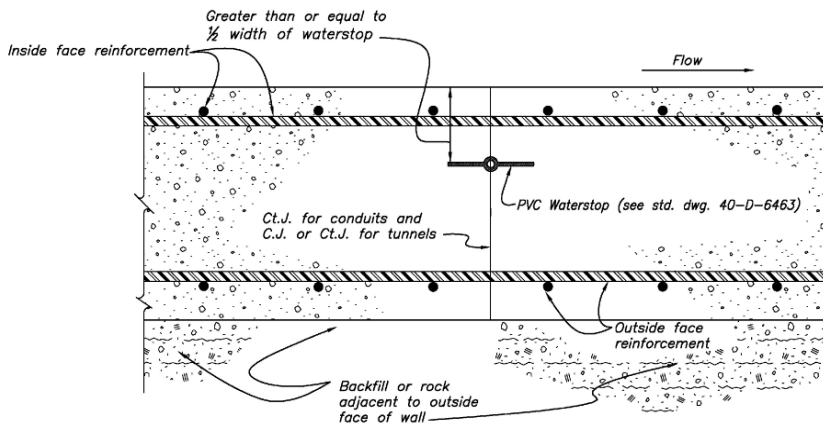
**Design Standards No. 14: Appurtenant Structures for Dams  
(Spillways and Outlet Works)**



**FLOW SURFACE SLAB – LONGITUDINAL CONTROL JOINT (Ct.J) ON ROCK OR SOIL FOUNDATION WITHOUT FOUNDATION KEY – APPLICABLE FEATURES ARE CONVEYANCE FEATURES (CHUTE) AND TERMINAL STRUCTURES (STILLING BASIN)**

**Notes:**

- Drilling drain spacing range from 5 to 10 feet between flow surface walls.
- "d" denotes diameter of HDPE drain
- \* Filter material around drains must meet filter requirements where needed.



**FLOW SURFACE CONDUIT OR TUNNEL – LATERAL (TRANSVERSE) CONTROL JOINT (Ct.J) THRU CONDUIT AND CONSTRUCTION JOINT (C.J.) OR Ct.J. THRU TUNNEL – APPLICABLE FEATURE IS CONVEYANCE FEATURE**

**Figure 3.8.6.1.3-3. Longitudinal CtJs for flow surface slabs and transverse CtJs and CJs for flow surface conduits and tunnels.**

**3.8.6.1.4 Surface Delamination Near CrJs and CtJs**

Delamination and/or spalling has been observed near exposed slab CrJs and CtJs and is associated with surface spillway features such as inlet structures, control structures, and chutes. It has been postulated that a leading contributor was expansion of concrete due to solar radiation (see figure 3.8.6.1.4-1). Additionally, corrosion of exposed reinforcing bars at open CtJs may occur where splicing of the reinforcing bars may create a plane of weakness. As a possible fix, a surface blackout may be considered to reduce the effects of temperature-induced (thermal) expansion. However, care needs to be applied when considering the use of these blockouts, including the following considerations:

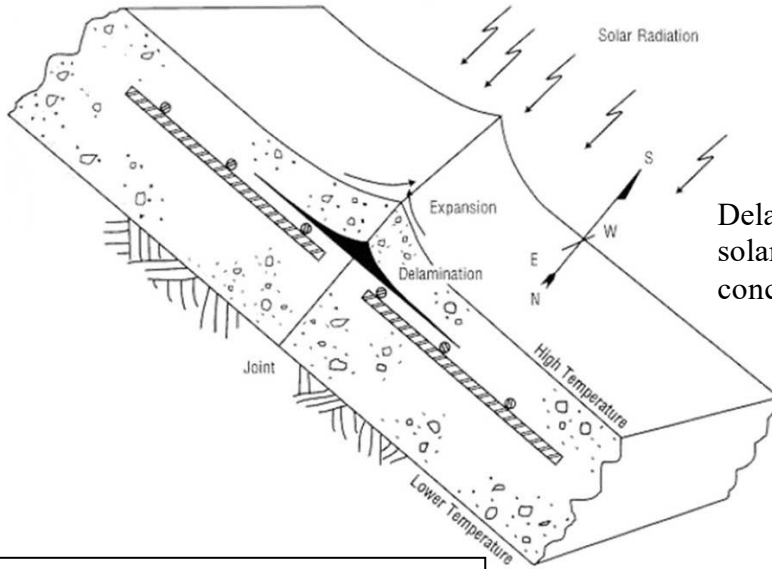
- A temperature study should be used to identify significant surface expansion potential of the concrete.
- Adverse hydraulics such as cavitation could be exacerbated by the blockouts. For this reason, blockouts should only be considered when the average flow velocities are less than 50 ft/s (maximum flow velocity evaluated in laboratory testing).
- Filler material (sealant) should adhere to the sides of the blackout to limit potential accumulation of water and other material.
- Inspection and repair (if needed) should be undertaken on a periodic basis and after each significant operation of the spillway (this effort could be significant in terms of time and cost to inspect and repair).

**3.8.6.1.5 Expansion Joints**

A fourth type of concrete joint used by Reclamation is the EJ, but it is seldom applicable to a reinforced concrete spillway. Exceptions are EJs associated with spillway bridges, hoist decks, and parapet walls. However, a brief discussion is provided, for completeness. The EJs are separated, unbonded surfaces used to prevent stress or load transfer from one feature or structure to another adjacent feature or structure (see figure 3.8.6.1.5-1). Materials such as corkboard, mastic, sponge rubber, or other compressible-type fillers are used to fill the gap between the joint surfaces. The size of the gap and thickness of the compressible material will depend on the magnitude of the anticipated movement (deformation). Orientation of EJs is vertical. Also, the orientation of EJs tends to be either perpendicular or parallel to the centerline of the spillway. An example is a bridge crossing a spillway at a diagonal angle to the spillway centerline. However, in this case, the EJs at both bridge abutments would be parallel to the centerline of the spillway and diagonal to the orientation of the bridge. The location and spacing of EJs should be governed by the physical features of the spillway, temperature study results, concrete placement methods, and the potential concrete placing capacity.

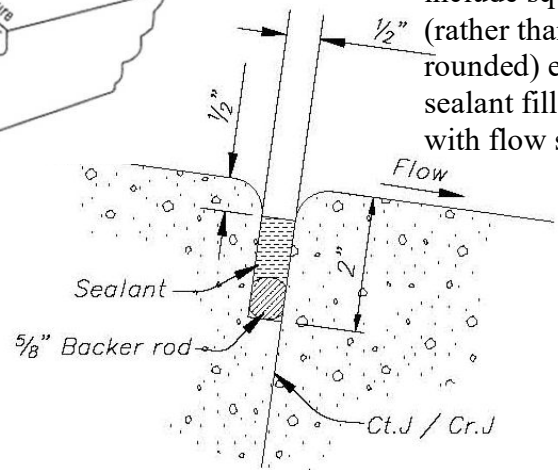


**Design Standards No. 14: Appurtenant Structures for Dams  
(Spillways and Outlet Works)**



Delamination near slab surface due to solar radiation induced expansion of concrete

Alternative configuration would include square (rather than rounded) edges and sealant filled flush with flow surface.

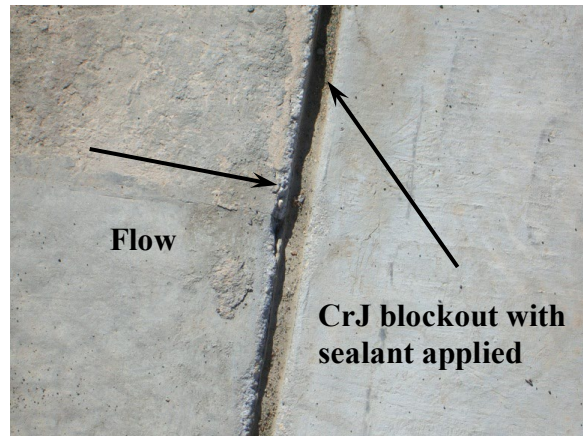


**JOINT BLOCKOUT DETAIL**

Blockout detail to mitigate delamination near joints on slab surface due to solar radiation induced expansion of concrete.

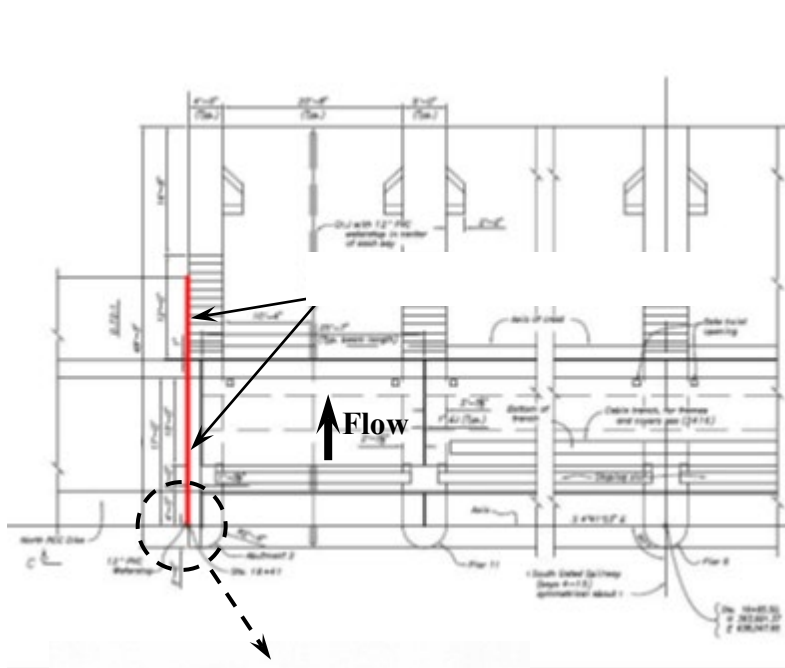
Limitations/considerations include:

- A temperature study should be used to identify significant surface expansion potential of the concrete.
- Adverse hydraulics, such as cavitation, could be exacerbated by the blockouts. For this reason, blockouts should only be considered when the average flow velocities are less than 50 ft/s (maximum flow velocity evaluated in laboratory testing).
- Filler material (sealant) should adhere to the sides of the blockout to limit potential accumulation of water and other material.
- Inspection and repair (if needed) should be undertaken on a periodic basis and after each significant operation of the spillway (this effort could be significant in terms of time and cost to inspect and repair).

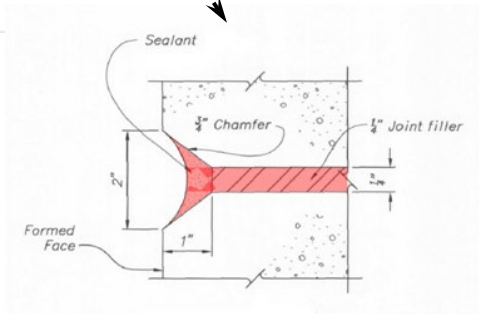


CrJ breakout detail between existing inlet structure flow surface (floor) and new crest structure flow surface (floor), Echo Dam, UT.

**Figure 3.8.6.1.4-1. Surface delamination near joints.**



Minidoka Dam, Idaho - Partial plan of spillway, which employs an expansion joint (EJ) at the interface between the spillway and North RCC Dike. This is an atypical application given that the EJ is exposed to (impounds) the reservoir.



Stewart Mountain Dam, Arizona – A more typical application of an expansion joint (EJ) is employing it in a parapet wall.

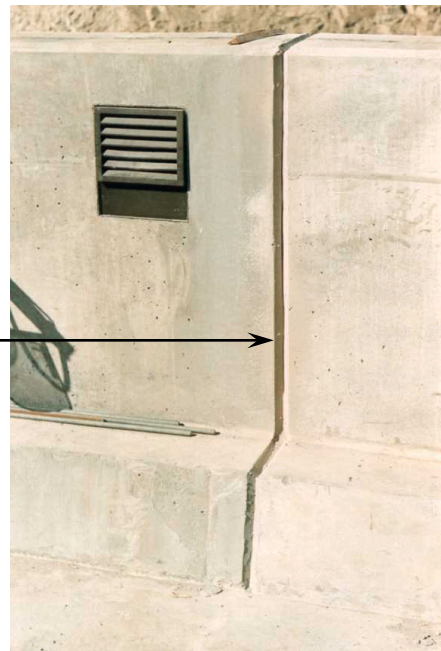


Figure 3.8.6.1.5-1. Expansion joints (EJs).

**Design Standards No. 14: Appurtenant Structures for Dams  
(Spillways and Outlet Works)**

**3.8.6.1.6 General Guidance for Selecting Joints**

Table 3.8.6.1.6-1 summarizes the general guidance for identifying and locating joints.

**Table 3.8.6.1.6-1. Concrete joints associated with spillway features**

Feature	Concrete joints			Comment
	CJ	CrJ	CtJ	
<b>Inlet structure:</b>				
Walls	X	X		CJs horizontal, diagonal; CrJs vertical and include waterstops (exposed to water)
Floors (rock foundation)	X	X	X	CJs horizontal, vertical, diagonal; CrJs normal to flow surface, with plain dowels and waterstops (exposed to water); CtJs normal to flow surface and with waterstops (exposed to water)
Floors (soil foundation)	X		X	CJs horizontal, vertical, diagonal; CtJs normal to flow surface and with waterstops (exposed to water)
<b>Control structure:</b>				
Walls	X	X		CJs horizontal, diagonal; CrJs vertical and include waterstops (exposed to water)
Floors (rock foundation)	X	X	X	CJs horizontal, vertical, diagonal; CrJs normal to flow surface, with plane dowels and waterstops (exposed to water); CtJs normal to flow surface and with waterstops (exposed to water)
Floors (soil foundation)	X		X	CJs horizontal, vertical, diagonal; CtJs normal to flow surface and with waterstops (exposed to water)
Piers	X			CJs horizontal, diagonal
Tower (such as morning glory)	X			CJs horizontal, diagonal
Grade control sill	X		X	CJs horizontal; CtJs normal to flow surface and with waterstops (exposed to water)
Cutoffs (foundation)	X		X	CJs horizontal, vertical, diagonal; CtJs normal to flow surface and with waterstops (exposed to water)

### Chapter 3: General Spillway Design Considerations

**Table 3.8.6.1.6-1. Concrete joints associated with spillway features**

Feature	Concrete joints			Comment
	CJ	CrJ	CtJ	
<b>Chute:</b>				
Walls	X	X		CJs horizontal, diagonal; CrJs vertical and include waterstops (exposed to water)
Retention walls	X		X	CJs horizontal, diagonal; CtJs vertical and with waterstops (exposed to water)
Floors (rock foundation)	X	X	X	CJs horizontal, vertical, diagonal; CrJs normal to flow surface, with plain dowels and waterstops (exposed to water); CtJs normal to flow surface and with waterstops (exposed to water)
Floors (soil foundation)	X		X	CJs horizontal, vertical, diagonal; CtJs normal to flow surface and with waterstops (exposed to water)
Cutoffs (foundation)	X		X	CJs horizontal, vertical, diagonal; CtJs normal to flow surface and with waterstops (exposed to water)
<b>Conduit:</b>	X		X	CJs horizontal, diagonal; CtJs normal to flow surface and with waterstops (exposed to water)
<b>Tunnel:</b>	X		X	CJs horizontal, diagonal, and normal to flow surface, with or without waterstops. CtJs limited to tunnel interface with other features near portals and control structures (such as gate chambers). Normal to flow surface and with waterstops (exposed to water)
<b>Terminal Structure:</b>				
Walls	X	X		CJs horizontal, diagonal; CrJs vertical and include waterstops (exposed to water)
Floors (rock foundation)	X	X	X	CJs horizontal, vertical, diagonal; CrJs normal to flow surface, with plain dowels and waterstops (exposed to water); CtJs normal to flow surface and with waterstops (exposed to water)
Floors (soil foundation)	X		X	CJs horizontal, vertical, diagonal; CtJs normal to flow surface and with waterstops (exposed to water)



**Design Standards No. 14: Appurtenant Structures for Dams  
(Spillways and Outlet Works)**

**Table 3.8.6.1.6-1. Concrete joints associated with spillway features**

Feature	Concrete joints			Comment
	CJ	CrJ	CtJ	
Cutoffs (foundation)	X		X	CJs horizontal, vertical, diagonal; CtJs normal to flow surface and with waterstops (exposed to water)
Chute blocks, dentates, sills	X			CJs horizontal, diagonal

As can be seen from table 3.8.6.1.6-1, both CrJs and CtJs have been, and can be, used for floor joints associated with a rock foundation. Some additional considerations (based on observations and experience) are summarized below, which relate to determining whether floor CrJs or CtJs should be used:

- Slabs with CrJs and CtJs are highly constrained (from movement) due to anchor bars and concrete-foundation cohesion. However, slabs with CtJs are more constrained given the continuous reinforcement that extends across the joint.
- Although differential settlement potential associated with a rock foundation would be expected to be very small (compared to a soil foundation), consideration should be given to this possibility. A CtJ (with continuous reinforcement across the joint) tends to provide more capability to bridge localized foundation settlement than a CrJ (with or without plain dowels or formed concrete keys extending across the joint).
- Where there is the potential for large daily fluctuations in temperatures near the concrete surface (example: some southerly facing spillway floor slabs can experience temperature changes of 70 °F or more), a CrJ may be a better choice than a CtJ. Also, as previously discussed in Section 3.8.6.1.4, “Surface Delamination Near CrJs and CtJs,” in this chapter expansion material may be considered if temperatures are expected to generate high compressive loads on the top surface of the concrete.

**3.8.6.2 Waterstops**

With very few exceptions, waterstops should be included with any flow surface CrJs and CtJs in slabs (floors), walls, and conduits/tunnels. This feature is an important defensive measure that helps mitigate adverse hydraulic conditions such as stagnation pressure potential (i.e., hydraulic jacking). Waterstops are seldom included with CJs or EJs. However, waterstops should be included for the rare case of an EJ being used in an impoundment structure (i.e., structure retains the reservoir, such as Minidoka Dam Modification, see figure 3.8.6.1.5-1).

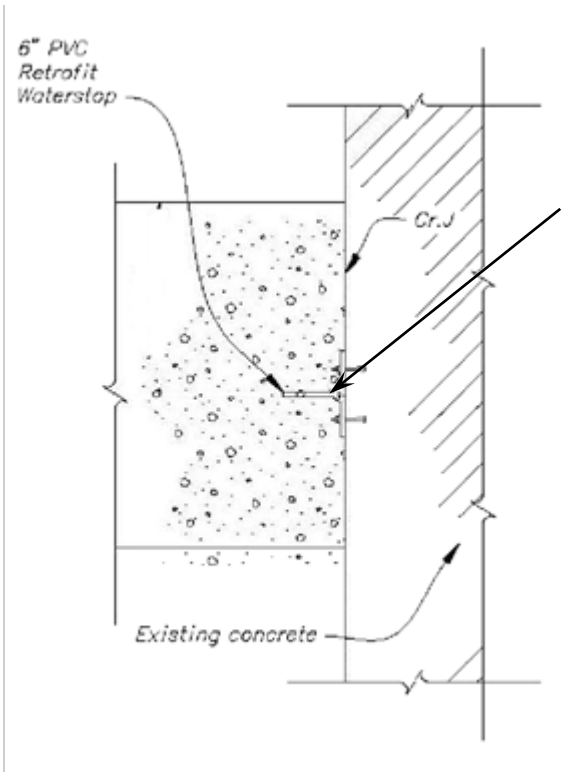
### Chapter 3: General Spillway Design Considerations

For new concrete (i.e., new concrete on either side of the joints), polyvinyl chloride (PVC) ribbed with center bulb waterstops are included with flow surface CrJs and CtJs (refer to standard drawing 40-D-6463). General guidance for locating and sizing PVC waterstops include:

- The overall width of the waterstop should not be greater than the thickness of the concrete slab, wall or conduit/tunnel lining (i.e., if the slab is 1 foot thick, the waterstop width should be less than 12 inches, which would result in selecting one of the standard widths of either 6 or 9 inches).
- The size (overall width) of the waterstop is also based on the hydraulic head (hydrostatic and/or stagnation pressure). The design head for different waterstop sizes is specified by the manufacturer.
- The dimension from the concrete face or surface to the embedded waterstop must not be less than half the width of the waterstop (i.e., if the waterstop has a 9-inch width, the embedment dimension must be greater than or equal to 4.5 inches).
- The width of the waterstop must be at least six times the maximum sized aggregate (MSA) used in the concrete mix design (i.e., If the MSA is 1½ inches, the waterstop must be at least 9 inches).

For the interface between existing-and new concrete, “retrofit” (PVC) and/or “strip” (hydrophilic) waterstops are included with CrJs and CtJs (and some CJs) (i.e., for joints associated with most flow surfaces and where moisture could be an issue). Potential considerations associated with hydrophilic waterstops include: (1) installation temperature must be met; (2) ensure that there is sufficient concrete cover to mitigate the potential for waterstop expansion cracking the surrounding concrete; and (3) many wet-dry cycles over time could reduce expansion potential of the waterstop. Location and size of these retrofit and/or strip waterstops are specified by the designer of record (see figure 3.8.6.2-1, which illustrates applications of retrofit and strip waterstops).

**Design Standards No. 14: Appurtenant Structures for Dams  
(Spillways and Outlet Works)**



Section illustrating retrofit waterstop application between existing and new features

Echo Dam, Utah: retrofit waterstop being installed at interface (contraction joint) between existing spillway inlet structure and new spillway crest structure.



Strip waterstop in shear key breakout between existing wall and new wall (construction joint), yet to be placed

**Figure 3.8.6.2-1. Retrofit and strip waterstops.**

### 3.8.6.3 Tolerances

Tolerances are the allowable concrete surface deviations of the constructed dimensions from the design dimensions [56, 57]. There are two types of tolerances, including structural deviations and surface tolerances or roughnesses. Structural deviations are associated with the line,<sup>54</sup> grade,<sup>55</sup> length, width, and plumb<sup>56</sup> requirements for a given structure (for additional information about structural deviations, refer to Reclamation’s standard guide specifications). The surface tolerances or roughnesses ( $T_s$ ) define the limits of allowable surface irregularity such as bulges, depressions, and offsets (see figure 3.8.6.3-1). Furthermore, it should be pointed out that the surface tolerances or roughnesses are different than surface finishes<sup>57</sup> and must be specified separately (for additional information about finishes, refer to Reclamation’s standard guide specifications). The surface roughnesses that apply to spillways are evaluated by identifying and measuring abrupt and gradual irregularities (see figure 3.8.6.3-2 and table 3.8.6.3-1). The following sections include:

- **Abrupt irregularity**, see Section 3.8.6.3.1 in this chapter.
- **Gradual irregularity**, see Section 3.8.6.3.2 in this chapter.
- **Surface roughness and cavitation potential**, see Section 3.8.6.3.3 in this chapter.
- **Surface roughness and other factors**, see Section 3.8.6.3.4 in this chapter.
- **Design procedure for selecting surface tolerances**, see Section 3.8.6.3.5 in this chapter.

---

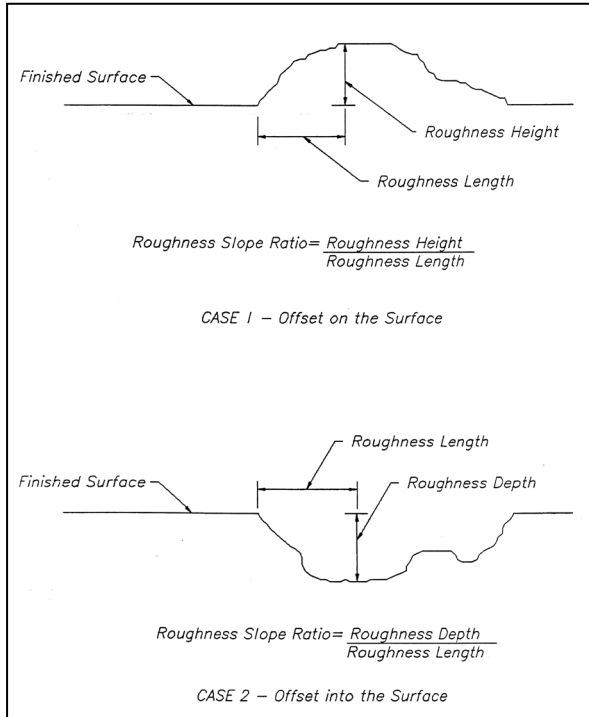
<sup>54</sup> Line deviation is the allowable structural variation in the horizontal placement (i.e., design alignment or station) of a structure.

<sup>55</sup> Grade deviation is the allowable structural variation from the grade elevation (i.e., design elevation of slab, floor, etc.) of a structure.

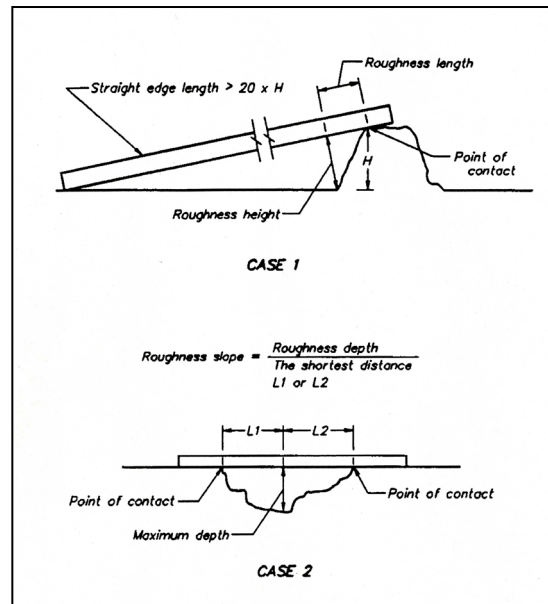
<sup>56</sup> Plumb deviation is the allowable structure variation from vertical and/or inclined surfaces (i.e., design vertical and/or battered surfaces such as walls, counterforts, etc.).

<sup>57</sup> Finishes result from surface texturing using specified methods to control surface blemishes. These finish methods could include steel trowling, sack rubbing, brooming, etc. Finishes are designated as either “F” for formed surfaces or “U” for unformed surfaces. For additional information, refer to Reclamation’s specifications guide paragraphs.

**Design Standards No. 14: Appurtenant Structures for Dams  
(Spillways and Outlet Works)**



**Figure 3.8.6.3-1. Surface roughnesses.**



**Figure 3.8.6.3-2. Measuring surface roughnesses.**

Table 3.8.6.3-1. Surface tolerances ( $T_s$ )

Concrete surface	Maximum allowable surface irregularity tolerances	
	Abrupt	Gradual
T1	1 inch	1/4 inch/inch
T2	1/2 inch	1/8 inch/inch
T3	1/4 inch	1/16 inch/inch
T4	1/8 inch	1/32 inch/inch
T5	1/32 inch	1/120 inch/inch

**3.8.6.3.1 Abrupt Irregularity**

As a general rule, abrupt irregularity refers to isolated surface roughnesses in which the dimension of the irregularity perpendicular to the surface is greater than its dimension parallel to the surface. Although this definition still applies, it has been broadened to include all isolated surface deviations that exceed the gradual irregularity definition that follows in Section 3.8.6.3.2, “Gradual Irregularity,” in this chapter. Normally, these surface roughnesses are most critical on high velocity flow surfaces. A smooth flow surface that contains abrupt irregularities is more susceptible surface to cavitation damage. The abrupt irregularity guideline is the most restrictive guideline (compared to the gradual irregularity guideline) and should be evaluated first. The abrupt irregularity must be measured to determine if it exceeds the abrupt irregularity flow surface tolerance; if so, appropriate concrete repair in accordance with the *Guide to Concrete Repair Manual* [57] may be warranted. Related to repair, it should be noted that contractors tend to prefer grinding concrete surfaces rather than removing and replacing them due to cost. However, grinding can result in a greater potential for eventual aggregate pop-out, which will create abrupt irregularities.

**3.8.6.3.2 Gradual Irregularity**

This is commonly referred to when describing isolated undulations in the concrete surface. The dimension of the roughness normal to the concrete surface is small relative to its dimension parallel to the concrete surface. Gradual irregularities are generally less critical than abrupt irregularities. Therefore, the maximum allowable depth (dimension perpendicular to the surface) of a gradual irregularity may be greater than the allowable abrupt surface tolerance. However, the maximum allowable gradual irregularity is limited by the controlling structural deviation (i.e., line or grade). As with the abrupt irregularity, the gradual irregularity must be measured to determine if it exceeds the gradual irregularity flow surface tolerance; if so, appropriate concrete repair in accordance with the *Guide to Concrete Repair Manual* [57] may be warranted.

**Design Standards No. 14: Appurtenant Structures for Dams  
(Spillways and Outlet Works)**

**3.8.6.3.3 Surface Roughness and Cavitation Potential**

As previously discussed in Section 3.6.3.1, “Conveyance Features,” in this chapter, surface tolerances or roughnesses ( $T_S$ ) have been correlated to cavitation index of flow ( $\sigma$ ). The following bullets summarize typical flow surface roughnesses applicable to cavitation index of flow values:

- If  $\sigma \geq 0.5$ , cavitation potential is diminished, but it is important that an appropriate flow surface roughnesses be achieved to minimize potential. This is done by specifying a  $T3$  flow surface roughness (abrupt offset  $\leq 1/4$  inch and gradual offset of 1 to 16 or flatter).
- If  $0.5 > \sigma > 0.2$ , provide a specified surface roughnesses, which is either a  $T3$  flow surface roughness (abrupt offset  $\leq 1/4$  inch and gradual offset of 1 to 16 or flatter) or  $T4$  flow surface roughness (abrupt offset  $\leq 1/8$  inch and gradual offset of 1 to 32 or flatter).
- If  $\sigma \leq 0.2$ , provide air entrainment (i.e., constructing an aeration ramp or slot) for existing spillways or redesign (realign) for new spillways. For more details, refer to Engineering Monograph No. 42, *Cavitation in Chutes and Spillways* [23].

**3.8.6.3.4 Surface Roughness and Other Factors**

In addition to considering the cavitation indices, other factors must be included in the final selection of the flow surface roughnesses or tolerances:

- Hydraulic head losses (excessive flow surface irregularities) could be detrimental, such as power loss due to high friction losses in a pressurized conveyance feature (i.e., tunnel and/or conduit).
- Construction concerns (can a specified flow surface roughness or tolerances be reasonably attained by the contractor?).
- Operation and maintenance concerns (potential of increased surface roughening over time). While surface damage caused by freeze-thaw cycles can be minimized by using air-entrained concrete, it may not be fully eliminated. Also, in conveyance features, such as tunnels and chutes, exposed to groundwater, surface deposits can accumulate through cracks due to seepage. It can be very difficult and expensive to maintain surface tolerances or roughnesses if they are too strict.
- Aesthetic concerns (public perception of visible portions of the structure).

**3.8.6.3.5 Design Procedure for Selecting Surface Tolerances**

The following design approach (see table 3.8.6.3.5-1) summarizes the steps in selecting flow surface tolerances or roughnesses.

For additional guidance about selecting surface roughnesses associated with nonflow surfaces, refer to Reclamation’s guide specifications.

**Table 3.8.6.3.5-1. Procedure for selecting surface tolerances (*T*s)**

<p>Step 1 <b>(Initial Spillway Layout)</b></p>	<p>Lay out the preliminary design configuration of the spillway, considering the alignment and profile. Hydraulically size the spillway to pass the maximum design flows (typically includes flood routings, along with water surface profile and cavitation indices profile analyses).</p>
<p>Step 2 <b>(Hydraulics – Cavitation Potential)</b></p>	<p>Evaluate the cavitation indices profile results, which should include a suite of cavitation indices profiles associated with a range of flows (up to the maximum design flow) anticipated to be passed by the spillway. Note that the critical cavitation indices condition (smallest cavitation indices) may be associated with flows less than the maximum design flows).</p>
<p>Step 3 <b>(Flow Surface Roughness)</b></p>	<p>Based on the correlation between cavitation indices and flow surface roughnesses, identify the flow surface tolerances. This should be based on the minimum value of the cavitation indices profiles.</p>
<p>Step 4 <b>(If Cavitation Indices &lt; 0.2, Repeat Steps 1-3)</b></p>	<p>If there are any cavitation indices less than 0.2, repeat Steps 1 through 3 to evaluate what effects might result on the cavitation indices by changing the geometry (alignment and/or profile) of the spillway and/or consider other types of spillways. Engineering Monograph No. 42, <i>Cavitation in Chutes and Spillways</i> [23], should be used to revise the preliminary design configuration and/or type of the spillway.</p>
<p>Step 5 <b>(If Cavitation Indices &lt; 0.2, Aeration Ramps/Slots)</b></p>	<p>If the cavitation indices cannot be reasonably increased (greater than 0.2) by changing the geometry or type of spillway, consideration should be given to including an aeration ramp or slot. Engineering Monograph No. 42, <i>Cavitation in Chutes and Spillways</i> [23] should be used for evaluating and designing an aeration ramp or slot.</p>
<p>Step 6 <b>(Nonhydraulic Factors)</b></p>	<p>Evaluate other factors that could influence the selection of the surface tolerances for the spillway. As an example, these factors could drive a <i>T3</i> flow surface tolerances (based on cavitation indices) to a <i>T4</i> flow surface tolerance (based on operation and maintenance concerns – can the surface roughness or tolerance be maintained over time at reasonable expenses?) or a <i>T5</i> (based on aesthetic concerns). Also, <i>T1</i> and <i>T2</i> nonflow surfaces (based primarily on hidden or buried surface conditions) might come into play.</p>

### 3.9 General Electrical/Mechanical Considerations

This section provides general electrical/mechanical considerations for determining the type, location, and size of a modified or new spillway. Detailed electrical/mechanical analysis and design can be found in Chapter 7, “Electrical/Mechanical Considerations for Spillways and Outlet Works,” in this design standard.



## Design Standards No. 14: Appurtenant Structures for Dams (Spillways and Outlet Works)

As previously noted, unless specified otherwise, this chapter is applicable to the evaluation, analysis, and design of reinforced concrete, high velocity, and high flow spillways.

### 3.9.1 Mechanical Features

Existing and new spillways may include mechanical features such as gates, bulkheads, stoplogs, and flashboards. These mechanical features are critical for safe and reliable operation and to facilitate maintenance of the spillway.

#### 3.9.1.1 Gates

Gates, unlike valves,<sup>58</sup> are movable, watertight devices that control the flow without obstructing any portion of the waterway when they are in a fully open position. Gated spillways provide control of the portion of the reservoir above the spillway crest, which can increase reservoir storage and help to regulate releases so that downstream adverse impacts (flooding) are minimized. This potential benefit can be offset by a lack of reliable operation (i.e., due to malfunctioning operating systems, binding of gates, debris blockage, etc.). The decision to include gates should be fully evaluated in the design of the spillway to ensure reliable operation.

The most common types of spillway gates used by Reclamation are radial gates,<sup>59</sup> both bottom- and top-seal radial gates (see figure 3.9.1.1-1), wheel-mounted gates<sup>60</sup> (see figure 3.9.1.1-2), and drum gates<sup>61</sup> (see figure 3.9.1.1-3). Three other types of gates have been used and include ring gates,<sup>62</sup> crest gates (bascule,<sup>63</sup> see figure 3.9.1.1-4; and Obermeyer,<sup>64</sup> see figure 3.9.1.1-5), and cylinder gates.<sup>65</sup> The selection of a particular spillway gate type depends on the geometry of the control (crest) structure, the housing of operating equipment, potential ice problems, and economics of the gate installation (compared to no gates). Additionally, possible settlement of the control structure and wall deflections are extremely important considerations affecting gate reliability [12]. Finally, the required discharge may

---

<sup>58</sup> Typically, valves are movable, watertight devices used to control the flow that permanently obstructs a portion of the waterway (the exception is a ball valve). As distinguished from gates, valves are constructed so that the closing member remains in the water passageway for all operating positions.

<sup>59</sup> Examples of radial gated spillways include: Buffalo Bill Dam and Theodore Roosevelt Dam (top-seal), Choke Canyon Dam, and Stewart Mountain Dam (bottom-seal).

<sup>60</sup> An example of a wheel-mounted gated spillway includes Morrow Point Dam.

<sup>61</sup> Some examples of drum gated spillways include: Grand Coulee Dam, Shasta Dam, and Hoover Dam.

<sup>62</sup> Some examples of ring gated spillways include: Owyhee Dam and Hungry Horse Dam.

<sup>63</sup> An example of a bascule crest gated spillway includes Dickinson Dam.

<sup>64</sup> An example of an Obermeyer crest gated spillway includes Friant Dam.

<sup>65</sup> An example of cylinder gates is the atypical spillway (combined ogee crest and gate towers with cylinder gates) at Elephant Butte Dam.



Figure 3.9.1.1-1. Radial gates.

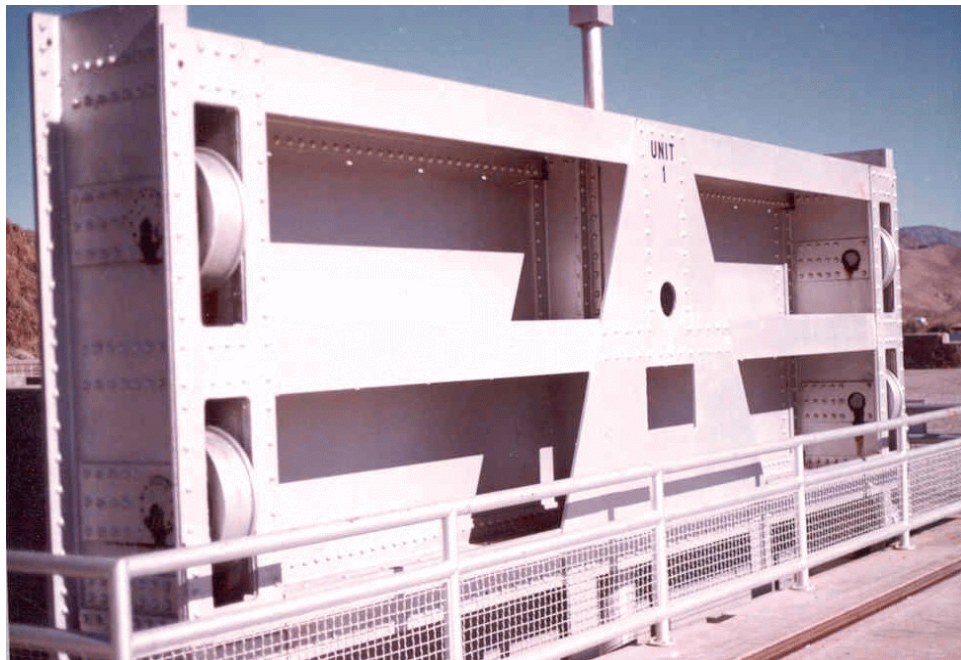


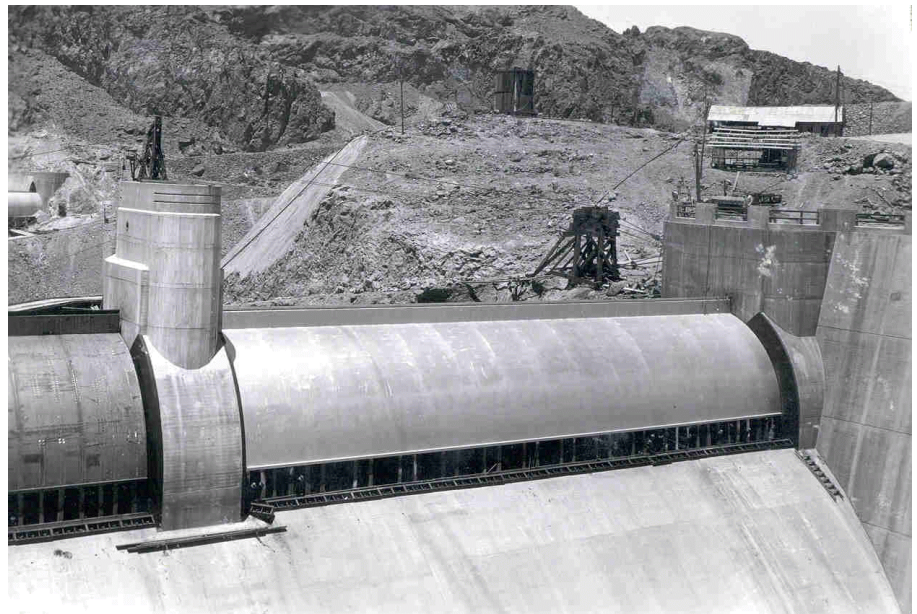
Figure 3.9.1.1-2. Wheel-mounted gates.

**Design Standards No. 14: Appurtenant Structures for Dams  
(Spillways and Outlet Works)**



Grand Coulee Dam,  
Washington: drum  
gated service spillway

Hoover Dam, Nevada-  
Arizona: drum gated  
service spillways



**Figure 3.9.1.1-3. Drum gates.**





Figure 3.9.1.1-4. Crest gate – bascule type.



Figure 3.9.1.1-5. Crest gate – Obermeyer type.

## **Design Standards No. 14: Appurtenant Structures for Dams (Spillways and Outlet Works)**

be associated with a nonstandard gate size. In this case, a larger standard gate size may be specified, which could result in larger discharge capacity than required.

Currently, radial gates (sometimes referred to as tainter gates by others) have been used almost exclusively by Reclamation for modified and new spillway designs. The first radial gates were installed at Jackson Lake Dam in 1916. Since then, there have been over 70 radial gate installations at Reclamation's inventory of spillways and outlet works. Within Reclamation's inventory, radial gate maximum sizes are in the range of 40 feet wide by 50 feet high<sup>66</sup>. Radial gates are exclusively used for regulating<sup>67</sup> releases and have had a very good performance history [58, 59]. Note: Radial gates, as well as other gates (wheel-mounted gates and some crest gates), require a hoist deck for gate operating systems. All gates require operating equipment that must be maintained, such as wire ropes or chains associated with radial gates. Operating equipment for these gates may require an access bridge (hoist deck) or structure to accommodate the operating equipment.

### **3.9.1.2 Bulkheads**

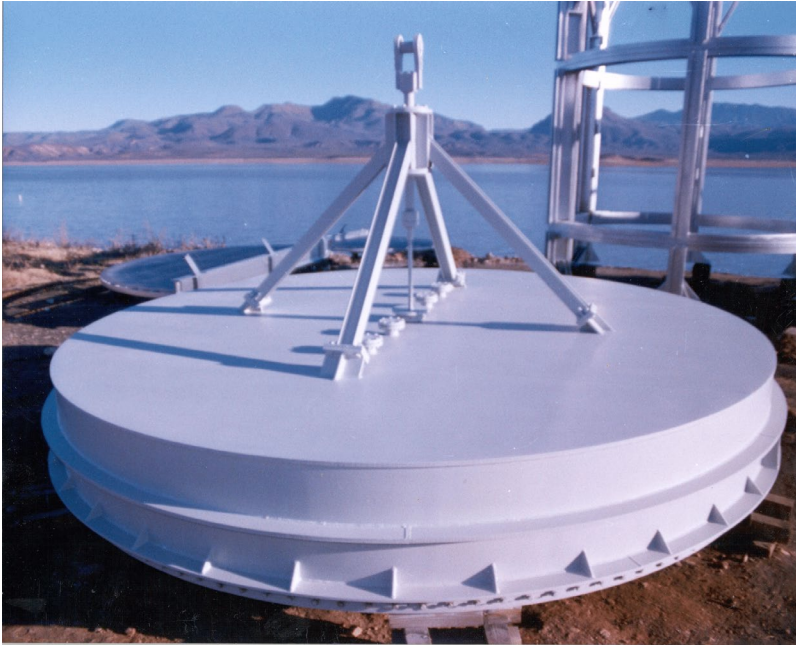
Bulkheads or bulkhead gates are mechanical features used to isolate the downstream spillway (including regulating gates) from the reservoir or from tailwater, which is done to facilitate maintenance operations and inspection of normally inundated portions of the spillway [60]. The bulkhead is a flat, structurally reinforced gate leaf with rubber seals, which comes in various shapes and sizes to fit a particular control structure. The bulkhead normally fits into vertical gate slots for horizontal flow entry type control structures, such as a gated ogee crest control structure, or it is atop vertical entry type control structures, such as a drop inlet control structure (figure 3.9.1.2-1). Bulkheads or bulkhead gates are used in lieu of stoplogs when the control structure entrance is submerged (such as for a top-seal radial gate or wheel-mounted gate installation). Installation is usually done by gantry or mobile crane, barge-mounted crane, and some very large bulkheads are designed to be floated into place. Note: For almost all bulkhead installations, balanced head conditions<sup>68</sup> must be maintained. Bulkheads are not intended for emergency closure. For submerged control structures, the bulkheads must be equipped with a filling line and, in some instances, with an air vent. The largest bulkhead in Reclamation's inventory is 55- by 55 feet. The largest circular bulkhead is 20-foot-diameter. The amount of leakage associated with a bulkhead is usually determined by the condition of the slots or the seals. Of note, for deeply submerged control structures, divers may be required to facilitate the installation and removal of bulkheads, which means that

---

<sup>66</sup> Examples of the installation of larger radial gates include: Haipu Dam in Brazil (65.6- by 70-foot gates) and Guri Dam in Venezuela (50- by 68.3-foot gates) [12].

<sup>67</sup> The term "regulating" is associated with a gate that can be operated under unbalanced hydraulic head conditions (i.e., when releases are occurring).

<sup>68</sup> The term "balanced head conditions" refers to equal pressure on the upstream and downstream sides of the bulkhead during installation and removal.



Metal circular bulkhead for drop inlet spillways

Parker Dam, Arizona: metal bulkhead for fixed-wheel mounted gate spillway



Figure 3.9.1.2-1. Bulkhead.



## **Design Standards No. 14: Appurtenant Structures for Dams (Spillways and Outlet Works)**

a balanced head condition must be maintained during installation and removal. Design considerations include recognizing that the span or width of a bulkhead is limited by deflection, crane capacity, and site delivery limitations. Bulkheads or bulkhead gates, or at least gate slots, should be part of a spillway design where it may not be possible to lower the reservoir below the spillway crest elevation on an as-needed basis.

In some cases, consideration should be given to including bulkhead slots and bulkheads for the terminal structure (such as a hydraulic jump stilling basin) where periodic unwatering of the terminal structure may be required. Such an application would typically only be feasible and/or cost effective for a relatively narrow terminal structure in the range of 30 feet or less. As a reminder, if there will be a need to unwater the terminal structure, design considerations will include ensuring floatation stability of the unwatered terminal structure subject to normal tailwater conditions (see Section 3.8.3, “Stability Design,” in this chapter for more details).

### **3.9.1.3 Stoplogs**

Stoplogs have a similar purpose as bulkheads. A stoplog is a mechanical feature used to isolate the downstream spillway (including regulating gates) from the reservoir in order to facilitate maintenance operations and inspect normally inundated portions of the spillway [60]. Also, stoplogs have been used to temporarily raise a reservoir. Stoplogs consist of individual beams, girders, or multiple beams and plates welded together to make one stoplog. Stoplogs are set one upon the other to form a watertight barrier supported by gate slots for a horizontal flow entry type control structure [12] (see figure 3.9.1.3-1). Stoplogs are typically used in lieu of a bulkhead when the entrance to the control structure is not submerged (such as a radial gate or drum gate control structure) or at the downstream end of a terminal structure (such as a hydraulic jump stilling basin). As previously noted for bulkheads, installing stoplogs at the downstream end of a terminal structure would typically only be feasible and/or cost effective for a relatively narrow terminal structure in the range of 30 feet or less. Similar to bulkheads, stoplog installation usually takes place by gantry or mobile crane and barge-mounted crane. Note: For all stoplog installations, balanced head conditions must be maintained. Stoplogs are not intended for emergency closure. Stoplogs, or at least slots, should be part of a spillway design where it may not be possible to lower the reservoir below the spillway crest elevation. Within Reclamation’s inventory, stoplog maximum sizes are in the range of 59 feet wide, and maximum stacked heights are about 258 feet high, with more typical stacked heights in the range of 50 feet or less.

As previously noted in Section 3.9.1.2, “Bulkheads,” in this chapter, in some cases, consideration should be given to including stoplog slots and stoplogs for the terminal structure (such as a hydraulic jump stilling basin) where periodic unwatering of the terminal structure may be required. Again, as a reminder, if there will be a need to unwater the terminal structure, design considerations will

### Chapter 3: General Spillway Design Considerations



Theodore Roosevelt Dam, Arizona: metal stoplogs for top-seal radial gated spillways



Folsom Dam, California: installation of metal stoplogs



Figure 3.9.1.3-1. Stoplogs.



## **Design Standards No. 14: Appurtenant Structures for Dams (Spillways and Outlet Works)**

include ensuring (floatation) stability of the unwatered terminal structure subject to normal tailwater conditions (see Section 3.8.3, “Stability Design,” in this chapter for more details).

### **3.9.1.4 Flashboards**

Flashboards are temporary barriers consisting of either timber, concrete, or steel and are anchored to the crest of a spillway to increase the reservoir storage. Flashboards can be removed, lowered, or carried away at the time of flooding. In some cases, flashboards or their supports have a tripping device or are designed to deliberately fail. Structural members of timber, concrete, or steel may be placed in channels or on the crest of a spillway to raise the reservoir water level but must be quickly removed in the event of a flood. Flashboards may provide a simple, economical type of movable crest device. An advantage of using flashboards is that an unobstructed crest exists when the flashboards and their supports are removed [12]. However, there are numerous disadvantages, which greatly limit their application, including:

- Flashboards could create a hazard if they are not removed in time to pass floods, especially when the reservoir is small and the stream or river is prone to flash flooding.
- Flashboards typically require attendance of an operator or crew to remove them unless they are designed to fail or trip at some point when the reservoir is elevated.
- If the flashboards fail when the reservoir is elevated, sudden releases could result.
- Flashboards are typically installed and removed under balanced hydrostatic head conditions unless they are designed to fail or trip due to some amount of hydrostatic head. There are some exceptions such as the automated flashboards at Shasta Dam that can be installed and removed under unbalanced head.

Reclamation has limited flashboard applications to extend the top of the gates or temporarily raise the spillway crest. Two examples include:

- Permanent, mechanically operated, 2-foot-high metal flashboards have been installed at Shasta Dam to extend the top of the three drum gates [60] (see figure 3.9.1.4-1).
- Temporary 21-inch-high timber flashboards have been installed and removed annually on both spillway crests at Lahontan Dam, which could increase storage [62] (see figure 3.9.1.4-2).

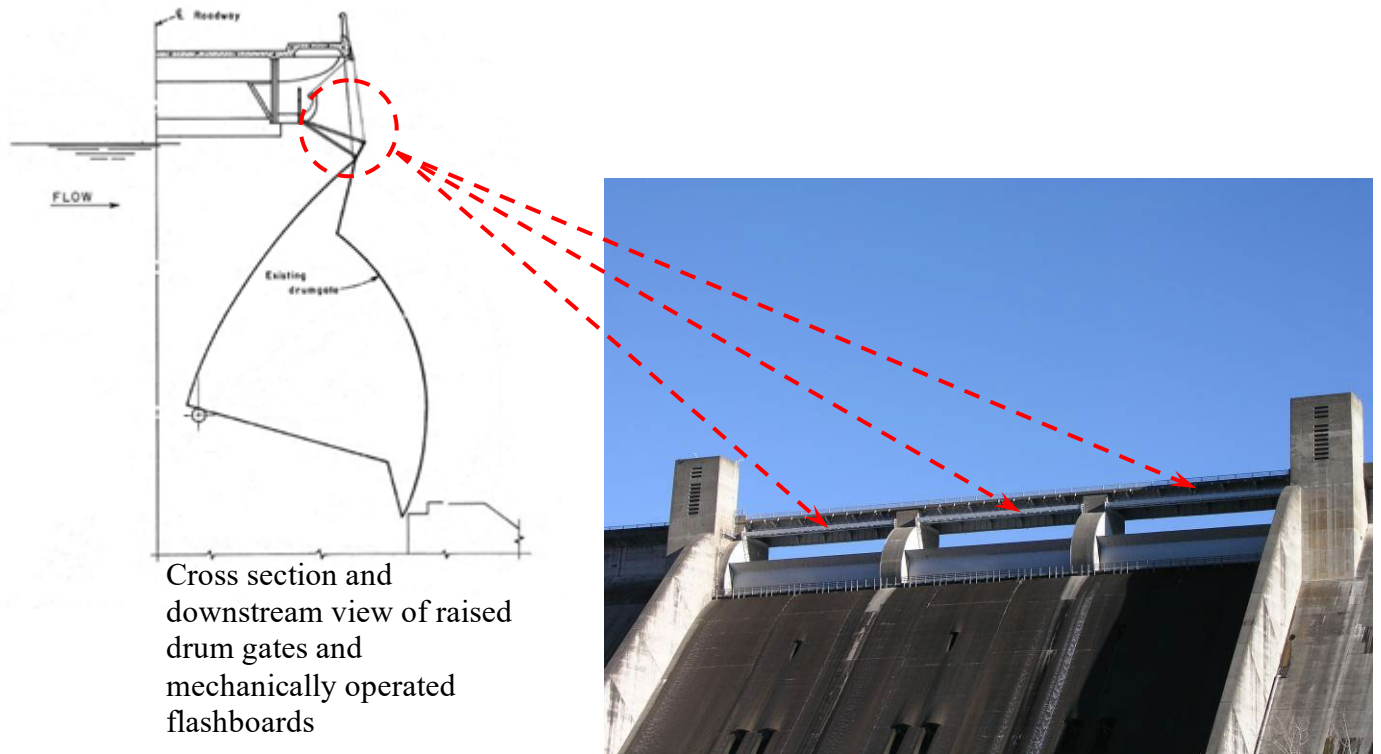


Figure 3.9.1.4-1. Flashboards – Shasta Dam spillway.



Figure 3.9.1.4-2. Flashboards – Lahontan Dam spillways.

### **3.9.2 Operating Systems**

Operating systems for gates are either manual or automatic. Details of the operating system will vary with the type of gate and type of hoisting equipment. Spillway gates can be operated by gear screw lifts, stems, hydraulic hoists, electrically powered mechanical hoists with wire ropes or chains connected to the gates, or by hydraulically using floats and wire ropes. Additional considerations include:

- Geared screw lifts are used on many small- or medium-sized gates.
- Hydraulic hoists are used for large, high-head gates because of their hoisting capacities, simple design, ease of control, and operating reliability. Hydraulic operating systems with float-operated gates (e.g., drum and some crest and radial gates) are used at many spillways because a reliable power supply and/or local operators were not available.
- Electrical operating systems can be used with geared screw lifts or hydraulic hoists. Present practice favors electrically operated mechanical hoists because of cost and reliability factors.

It is very important to have a backup or auxiliary power system (such as an engine generator) to operate spillway gates under unexpected or emergency conditions. Periodic inspection, maintenance, and testing requirements should be part of the design [12]. Also, manual operators have been included on some gates as an additional backup. Unassisted operation of these manual controls can take a long time to open a gate and can easily exhaust operating personnel. A portable power tool can provide assistance.

## **3.10 Instrumentation and Monitoring**

Reclamation's design approach for instrumentation and monitoring of dams does not focus on minimum instrumentation requirements. Instead instrumentation and monitoring needs are determined for each dam and its appurtenant structures on a case-by-case basis. For the most part, instrumentation and monitoring needs are based on monitoring and detecting key parameters (such as cracking or movement of spillway walls and/or floors) that would indicate initiation or progression of PFMs. This effort can include both data collection via instrumentation and periodic visual inspection which is based on a site-specific Ongoing Visual Inspection Checklist (OVIC). Common instrumentation for spillways includes structural measurement points, crack meters, and seepage measurement weirs.

There are a few exceptions<sup>69</sup> where instrumentation and monitoring may be based on the category of “general health monitoring,” which is not associated with any specific PFM. Such instrumentation and monitoring almost always is “high-value, low-cost”. Determining what does and does not represent appropriate “general health monitoring” is a continuing challenge with respect to defining dam safety monitoring programs.

For Reclamation storage and multipurpose dams, the instrumentation and monitoring program is defined in the Schedule for Periodic Monitoring (L-23), which summarizes the routine dam safety monitoring program, as well as presenting required monitoring in the event of unusually high reservoir levels and in the event of significant seismic shaking.

Consideration should be given to additional enhanced monitoring of spillways during operation. Visual observation of flow conditions in the conveyance features (upstream and downstream of the control structure, such as approach channels and chutes), control structures, terminal structures, and exit channels should be made along with photographic documentation. The visual observations and photographic documentation can be used to detect changes in flow conditions from past or predicted operations that may indicate changes in the spillway that may be associated with a PFM. Since spillway operations can be very infrequent (in some cases separated by many years), photographic documentation can be extremely helpful in detecting changes in flow patterns for similar discharges.

For evaluating and/or developing a instrumentation and monitoring program for an existing or new spillway, some coordination and consideration of the instrumentation and monitoring program for the existing or new dam must be included in the design. In this case, the reader is directed to *Design Standards No. 2, Concrete Dams*, and *Design Standard No. 13, Embankment Dams*.

### 3.11 Technical References

Technical references by Reclamation associated with analyzing and designing spillways include:

- *Reclamation Manual*, “Design Activities” [1].
- *Design of Small Dams*, Third Edition [3].
- *Reclamation Manual*, “Design Data Collection Guidelines” [6].

---

<sup>69</sup> Most common examples are structural measurement points placed on or embedded in spillway walls which are initially surveyed, then measurement points are put on standby status until a future event occurs (such as an earthquake) that may damage the structure, prompting another survey to determine any changes from the initial survey.

**Design Standards No. 14: Appurtenant Structures for Dams  
(Spillways and Outlet Works)**

- *Dam Safety Risk Analysis Best Practices Training Manual* [7].
- “Estimate Worksheet – Guide for Designers” [8].
- *Design of Spillways and Outlet Works for Dams – A Design Manual, Part II, Volume 1* [12].
- *Design of Small Canal Structures* [13].
- “Siphons, Conduit Abandonment, Slip Lining and Annulus Grouting Best Practices” (Draft) [14].
- Engineering Manual (EM) No. 9, *Discharge Coefficient for Irregular Overfall Spillways* [17].
- Assistant Commissioner – Engineering and Research Center (ACER) Technical Manual (TM) No. 3, *Criteria and Guidelines for Evacuating Storage Reservoirs and Sizing Low-Level Outlet Works* [22].
- EM No. 42, *Cavitation in Chutes and Spillways* [23].
- EM No. 41, *Air-Water Flow in Hydraulic Structures* [24].
- Dam Safety Office (DSO)-07-07, *Uplift and Crack Flow Resulting from High Velocity Discharge Over Offset Joints* [26].
- EM No. 25, *Hydraulic Design of Stilling Basins and Energy Dissipators* [27].
- Research Report No. 24, *Hydraulic Design of Stilling Basin for Pipe or Channel Outlet* [28].
- *Computing Degradation and Local Scour* [30].
- *Engineering Geology Field Manual, Volume 1* [35].
- *Guideline for Performing Foundation Investigation for Miscellaneous Structures* [36].
- *Design of Spillways and Outlet Works for Dams – A Design Manual, Part II, Volume 2* [37].
- *Engineering Geology Field Manual, Volume 2* [38].

### Chapter 3: General Spillway Design Considerations

- REC-ERC-82-17, *Frost Action in Soil Foundations and Control of Surface Structure Heaving* [41].
- *Drainage for Dams and Associated Structures Manual* [42].
- *Design Criteria for Concrete Retaining Walls* [44].
- *Interim Dam Safety Public Protection Guidelines* [46].
- “Reinforced Concrete Design and Analysis Guidelines” (Draft) [47].
- Position Paper, “Detailed Concrete Reinforcement Design Drawings” [52].
- TM No. TSC-8100-Standards-2011-1, Standard Drawing 40-D-6263 – Revision 8 – “Background and Development” [54].
- Standard 8130-1, *Working Document – Detailed Reinforcement Drawing Guidelines* [55].
- *Concrete Surface Tolerances, Finishes, and Curing Reference Material* [56].
- *Guide to Concrete Repair* [57].
- “Working Document - Gates and Valves ” [58].
- *Guidelines for Safety Evaluation of Mechanical Equipment* [59].
- ACER TM No. 4, *Criteria for Bulkheading Outlet Works Intakes for Storage Dams* [60].
- EM No. 27, *Moments and Reactions for Rectangular Plates* [63].
- EM No. 14, *Beggs Deformeter Stress Analysis of Single Barrel Conduits* [64].
- Memorandum, “Analysis of Additional Conduit Shapes” [65].

## 3.12 References

- [1] *Reclamation Manual, Directives and Standards, “Design Activities,”* Bureau of Reclamation, January 2008.

**Design Standards No. 14: Appurtenant Structures for Dams  
(Spillways and Outlet Works)**

- [2] *National Engineering Handbook*, Chapter 50, “Earth Spillway Design,” Natural Resources Conservation Service, August 1997.
- [3] *Design of Small Dams*, third edition, Bureau of Reclamation, 1987.
- [4] *Final Design Process*, Bureau of Reclamation, April 2008.
- [5] *Safety of Dams Project Management Guidelines*, Bureau of Reclamation, 2003.
- [6] *Reclamation Manual, Directives and Standards*, “ Design Data Collection Guidelines,” Bureau of Reclamation, September 2007.
- [7] *Dam Safety Risk Analysis Best Practices Training Manual*, Version 2.2, Bureau of Reclamation, April 2011.
- [8] “Estimate Worksheet – Guide for Designers,” Bureau of Reclamation, April 2010.
- [9] “Technical Manual: Overtopping Protection for Dams” (Draft), Federal Emergency Management Agency, due 2013..
- [10] HL-2012-02, *Performance of Type III Stilling Basins – Stepped Spillway Studies (Do Stepped Spillways Affect Traditional Design Parameters?)*, Bureau of Reclamation, May 2012.
- [11] HL-2009-07, *Cavitation Potential of the Folsom Auxiliary Stepped Spillway*, Bureau of Reclamation, December 2009.
- [12] *Design of Spillways and Outlet Works for Dams – A Design Manual*, Part II, Volume I, Chapters 1 through 5, Bureau of Reclamation, February 1988.
- [13] *Design of Small Canal Structures*, Bureau of Reclamation, 1974.
- [14] “Siphons, Conduit Abandonment, Slip Lining and Annulus Grouting Best Practices” (Draft), Bureau of Reclamation, September 2009.
- [15] *Hydraulics and Design of Fusegates*, Hasan T. Kocahan, Hydroplus, Inc, July 2005.
- [16] *Open-Channel Hydraulics*, Ven Te Chow, Ph.D., McGraw-Hill Civil Engineering Series, 1959.
- [17] EM No. 9, *Discharge Coefficient for Irregular Overfall Spillways*, Bureau of Reclamation, March 1952.



### Chapter 3: General Spillway Design Considerations

- [18] EM 1110-2-1603, *Hydraulic Design of Spillways*, U.S. Army Corps of Engineers, January 1990.
- [19] *Discharge Measurement Structures*, Publication 20, M.G. Bos, International Institute for Land Reclamation Improvement, 1989.
- [20] *Handbook of Hydraulics*, Sixth Edition, Ernest F. Brater and Horace Williams King, 1976.
- [21] Paper: “The Prismoidal Correction Revisited,” R.E. Deakin and M.N. Hunter, 22<sup>nd</sup> Victorian Regional Surveying Conference, February 2009.
- [22] ACER TM No. 3, *Criteria and Guidelines for Evacuating Storage Reservoirs and Sizing Low-Level Outlet Works*, 1990.
- [23] EM No. 42, *Cavitation in Chutes and Spillways*, Bureau of Reclamation, April 1990.
- [24] EM No. 41, *Air-Water Flow in Hydraulic Structures*, Bureau of Reclamation, December 1980.
- [25] EM-1110-2-1601, *Hydraulic Design of Flood Control Channels*, U.S. Army Corps of Engineers, June 1994.
- [26] DSO-07-07, *Uplift and Crack Flow Resulting from High Velocity Discharge Over Offset Joints*, Bureau of Reclamation, December 2007.
- [27] EM No. 25, *Hydraulic Design of Stilling Basins and Energy Dissipators*, Bureau of Reclamation, March 1984.
- [28] Research Report No. 24, *Hydraulic Design of Stilling Basin for Pipe or Channel Outlets*, Bureau of Reclamation, 1978.
- [29] Technical Notes: “Computing the Trajectory of Free Jets,” Tony L. Wahl et. al., *ASCE Journal of Hydraulic Engineering*, February 2008.
- [30] *Computing Degradation and Local Scour*, Technical Guideline for Bureau of Reclamation, January 1984.
- [31] *Prediction of Scour Depth from Free Falling Flip Bucket Jets*, Yildiz, D., and E. Uzucek, International Water, Power, and Dam Construction, November 1994.

**Design Standards No. 14: Appurtenant Structures for Dams  
(Spillways and Outlet Works)**

- [32] *Free Jet Scour Below Dams and Flip Buckets*, Mason, P.J., and K. Arumugam, *ASCE Journal of Hydraulic Engineering*, Vol. 111, No. 2, 1985.
- [33] *Earth and Rock Surface Spillway Erosion Risk Assessment*, Wibowo, J.L., D.E. Yule, and E. Villanueva Proceedings, 40<sup>th</sup> U.S. Symposium on Rock Mechanics, Anchorage Alaska, 2005.
- [34] *Design of Riprap Revetment*, Hydraulic Engineering Circular No. 11, Publication No. FHWA-IP-89-016, Federal Highway Administration, March 1989.
- [35] *Engineering Geology Field Manual*, Second Edition, Volume 1, Bureau of Reclamation, 1998.
- [36] *Guideline for Performing Foundation Investigation for Miscellaneous Structures*, Bureau of Reclamation, December 2004.
- [37] *Design of Spillways and Outlet Works for Dams – A Design Manual*, Part II, Volume II, Chapters 6 and 7, Bureau of Reclamation, February 1988.
- [38] *Design Standards No. 13, Embankment Dams*, Chapter 3, “Foundation Surface Treatment,” Draft Phase 1 (Initial Draft Review), Bureau of Reclamation, March 2013.
- [39] *Engineering Geology Field Manual*, Second Edition, Volume 2, Bureau of Reclamation, 2001.
- [40] *Recommendations for Prestressed Rock and Soil Anchors*, Fourth Edition, Post Tensioning Institute, 2004.
- [41] REC-ERC-82-17, *Frost Action in Soil Foundations and Control of Surface Structure Heaving*, Bureau of Reclamation, June 1982.
- [42] *Drainage for Dams and Associated Structures Manual*, Bureau of Reclamation, 2004.
- [43] *Minimum Design Loads for Buildings and Other Structures*, ASCE Standard, ASCE/SEI 7-05, 2010.
- [44] *Design Criteria for Concrete Retaining Walls*, Report of the Task Committee on Design Criteria for Retaining Walls, Bureau of Reclamation, August 1971.

### Chapter 3: General Spillway Design Considerations

- [45] *Guidelines for Earthquake Design and Evaluation of Structures Appurtenant to Dams*, United States Committee On Large Dams, May 1995.
- [46] *Interim Dam Safety Public Protection Guidelines*, Bureau of Reclamation, August 2011.
- [47] “Reinforced Concrete Design and Analysis Guidelines” (Draft), Bureau of Reclamation, April 2009.
- [48] *ACI Code Requirements for Environmental Engineering Concrete Structures and Commentary*, ACI 350-06, ACI Committee 350, American Concrete Institute, 2006.
- [49] *Building Code Requirements for Structural Concrete and Commentary*, ACI 318-11, ACI Committee 318, American Concrete Institute, November 2011.
- [50] EM-1110-2-2104, *Strength Design for Reinforced Concrete Hydraulic Structures*, adapted from U.S. Army Corps of Engineers, 1993.
- [51] *Evaluation of Reinforcing Bars in Old Reinforced Concrete Structures*, Engineering Data Report Number 48, CRSI, 2001.
- [52] “Position Paper: Detailed Concrete Reinforcement Design Drawings,” Technical Service Center (TSC), Civil Engineering Services, March 2000.
- [53] *ACI Detailing Manual-2004*, SP-66(04), ACI Committee 315, American Concrete Institute, 2004.
- [54] Standard Drawing 40-D-6263 - Revision , “Background and Development,” Technical Memorandum No. TSC-8100-Standards-2011-1, Bureau of Reclamation, Technical Service Center, August 2011.
- [55] *Working Document: Detailed Reinforcement Drawing Guidelines*, Standard 8130-1, Technical Service Center, March 2001.
- [56] *Concrete Surface Tolerances, Finishes, and Curing Reference Material*, Bureau of Reclamation, January 1990.
- [57] *Guide to Concrete Repair*, Bureau of Reclamation, Technical Service Center, April 1997.

**Design Standards No. 14: Appurtenant Structures for Dams  
(Spillways and Outlet Works)**

- [58] Working Document: “Gates and Valves,” Bureau of Reclamation, Not dated.
- [59] *Guidelines for Safety Evaluation of Mechanical Equipment*, Bureau of Reclamation, 1992.
- [60] ACER TM No. 4, *Criteria for Bulkheading Outlet Works Intakes for Storage Dams*, 1982.
- [61] *Comprehensive Facility Review – Shasta Dam – Central Valley Project – Shasta/Trinity – California* , Mid-Pacific Region, Bureau of Reclamation, August 2008.
- [62] *Comprehensive Facility Review – Lahontan Dam – Newlands Project – Nevada*, Mid-Pacific Region, Bureau of Reclamation, January 2011.
- [63] EM No. 27, *Moments and Reactions for Rectangular Plates*, Bureau of Reclamation, 1976.
- [64] EM No. 14, *Beggs Deformeter Stress Analysis of Single Barrel Conduits*, Bureau of Reclamation, 1968.
- [65] Memorandum , To: Head, Structural Behavior and Analysis Section,  
From: C.L. Mantei, Subject: Analysis of Additional Conduit Shapes,  
Bureau of Reclamation, 1971.

## **Appendix A**

### **Examples: Spillway Location, Type, and Size**

Example No. 1. – Dam T Modifications (Existing Embankment Dam):  
Modify Existing Service Spillway and Construct New Auxiliary Spillway

Example No. 2. – Dam R (New Embankment Dam): Construct New  
Service Spillway

Example No. 3. – Dam Q (New Concrete Dam): Construct New Service  
Spillway



# Example No. 1 – Dam T Modifications (Existing Embankment Dam): Modify Existing Service Spillway and Construct New Auxiliary Spillway

## Background

Dam T is located approximately 4 miles upstream from the nearest town in Montana. The dam was completed in 1962 and provides a total storage capacity of 1,575,000 acre-feet at the design maximum reservoir water surface (RWS) elevation 5250.0. The reservoir provides flood control, recreation, irrigation water, hydroelectric power, pollution abatement, wildlife conservation, and municipal and industrial water. The existing major features are summarized below:

- **The zoned embankment dam** has a structural height of 250 feet, a crest width of 35 feet, a crest length of 2,200 feet, and a crest elevation of 5256 feet.
- **One embankment dike** has a total crest length of 1,750 feet and maximum height of 25 feet, with a crest width of 25 feet at elevation 5256, and extends across a low area on the south reservoir rim.
- **The reinforced concrete service spillway** is located on the left abutment of the dam and consists of an unlined approach channel, an uncontrolled ogee crest structure, a chute, and stilling basin. The spillway is designed to release up to 10,500 cubic feet per second (ft<sup>3</sup>/s) at the design maximum RWS elevation 5250. Based on hydraulic analysis it was determined that adverse hydraulic conditions (overtopping of chute walls and sweepout of the stilling basin) would occur for RWSs that exceed 5252 feet (about 12,500 ft<sup>3</sup>/s). Of note, with a RWS equal to the dam/dike crest of 5256 feet, adverse hydraulic conditions would be significant. The spillway has operated on an annual basis with a maximum historical release of 3,500 ft<sup>3</sup>/s.
- **The outlet works**, located through the south (right) reservoir rim, consists of a 25-foot-diameter concrete-lined conduit and tunnel with a penstock bifurcation near the powerplant. The outlet works has a design discharge capacity of 2,500 ft<sup>3</sup>/s at the design maximum RWS elevation 5250. Due to high tailwater conditions and potential flooding of the control house, the outlet works is closed and not available to help pass flood events.

## Design Standards No. 14: Appurtenant Structures for Dams (Spillways and Outlet Works)

- A **powerplant** is located near the termination of the outlet works approximately 4,000 feet south of the dam. Approximately 1,500 ft<sup>3</sup>/s can be released through the powerplant. Due to high tailwater conditions and potential flooding of the powerplant, the powerplant is closed and not available to help pass flood events.

It was determined that total baseline risks primarily due to flood-induced overtopping of the dam and/or dikes were unacceptably high, and there was increasing justification to reduce total risks. Flood routings identified that frequency flood return periods greater than 7,500 years, about 30 percent of the peak inflow of the current critical Probable Maximum Flood (PMF), would overtop the dam and dike, which in turn could lead to failure of the dam and/or dikes and uncontrolled release of the reservoir.

Using the process for selecting the Inflow Design Flood (IDF), detailed in Chapter 2, “Hydrologic Considerations” in this design standard, a frequency flood equal to a return period of 100,000 years was selected as the IDF (approximately 50 percent of the peak inflow of the current critical PMF). This resulted in the modified total risks being reduced to acceptable levels, which is in an area of the f-N Chart associated with decreasing justification to take action to reduce risks. It should be noted that preliminary flood routings were done assuming a range of dam/dike raises and various amounts of increased discharge capacity to assess total risk reduction.

With the selection of the IDF, the spillway location, type, and size are determined which are discussed in the following sections. For more information, the reader is directed to the data table which is part of the *Checklist – Spillway Design Considerations* found in this chapter.

### Hydraulic Structure Location

Based on preliminary flood routings, it was determined that a combination of increasing the discharge capacity and increasing the flood surcharge storage by raising the dam and dike crests would likely be needed to safely pass the IDF. Site-specific conditions and considerations influenced the location of the hydraulic structure(s) needed to increase the discharge capacity. These conditions and considerations include:

- A landslide is located just to the left of the existing service spillway adjacent to the lower portion of the chute and the terminal structure (stilling basin). This would create significant and costly engineering and geologic challenges associated with increasing the size of the existing service spillway.



### Chapter 3: General Spillway Design Considerations

- As previously noted, RWS elevations exceeding 5252 feet will result in adverse hydraulics that could lead to potential failure modes (PFMs) associated with erosion of the dam (adjacent to the right side of the spillway) and/or erosion of the landslide and fill material (adjacent to the left side of the spillway). Both PFMs could result from erosional headcutting upstream to the existing reservoir, resulting in uncontrolled releases. With the likelihood of raising the existing dam and subsequent increases in the maximum RWS, modifications to the existing spillway will be needed to maintain maximum discharges at or near the design discharge of 10,500 ft<sup>3</sup>/s, to avoid adverse hydraulic conditions.
- Both dam abutments and downstream dam toe would pose costly and significant engineering and geologic challenges associated with overtopping protection modifications.
- Tunneling or cut-and-cover excavation for a subsurface (underground) conveyance feature (tunnel or conduit) through or near the dam right abutment or through the reservoir rim was determined to be technically feasible, but very expensive. This is due to the very large size of the conveyance feature needed to adequately augment the modified service spillway discharge in passing the IDF.
- Construction risks can be minimized if the existing service spillway is available to pass floods during the construction of a new hydraulic structure. Once the new hydraulic structure is completed and available to pass floods, the existing service spillway can be modified.
- The reservoir rim near the existing dike provides a suitable location for a new hydraulic structure. Geologic investigations indicate that sound rock foundation is located less than 10 feet below overburden. Also, a relatively short reach (ravine) exists between the reservoir rim and the downstream river. Finally, there is limited overburden (above the rock foundation) along the ravine, and geologic/engineering testing and analysis has indicated limited erosion potential, such that erosion armorment may not be needed along the ravine.

Given the previously noted site-specific conditions and considerations, a new hydraulic structure (auxiliary spillway) will be located through the reservoir rim near the existing dike. For more information, the reader is directed to the data table which is part of the *Checklist – Spillway Design Considerations* found in this chapter.

#### Hydraulic Structure Type and Size

It should be noted that the existing service spillway will be modified with a headwall placed above the ogee crest which will form an orifice opening that has

**Design Standards No. 14: Appurtenant Structures for Dams  
(Spillways and Outlet Works)**

been sized to limit maximum discharge to no more than the original design discharge capacity. The modified service spillway discharge capacity will be augmented by the new auxiliary spillway discharge capacity.

A number of auxiliary spillway types were eliminated including:

- **Overtopping protection of the dam and dike.** – Based on previous site-specific conditions and considerations, the dam and dike abutments and downstream toes would pose significant and costly engineering/geologic challenges associated with overtopping protection modifications.
- **Drop inlet control structures, including morning glory control structures.** – These control structures are associated with tunnel and/or conduit conveyance features. With this in mind and based on previously noted site-specific conditions and considerations, tunneling or cut-and-cover excavation for an underground conveyance feature (tunnel or conduit) through or near the dam right abutment or through the reservoir rim was determined to be technically feasible, but very expensive. This is due to the very large size of the conveyance feature needed to adequately augment the modified service spillway discharge capacity, when passing the IDF.
- **Gated control structure.** – Appraisal-level costing of gated control structures suggests significant expense that would greatly exceed other types of control structures.

Types of spillways that were further evaluated included:

- **Ogee crest control structure.** – After evaluating multiple spillway crest elevations, the auxiliary spillway crest was set at elevation 5236, which is two feet above the service spillway crest elevation of 5234 feet. The crest elevation was set by selecting the highest excavated elevation that would provide a suitable foundation, and still provide acceptable hydraulic conditions and meet reservoir operation requirements. Different auxiliary spillway crest widths ranging from 50 feet to 400 feet were evaluated.
- **Fuseplug control structure.** – One, two, and three section fuseplug embankments were evaluated. Pilot channel elevations were established to accommodate flood return periods which if exceeded would result in operation of a fuseplug section. The configuration of the fuseplug control structure is based on an iterative process of evaluating combinations of number of fuseplug sections, widths of sections, and height of sections (pilot channel elevation). A three section fuseplug spillway was selected to further evaluate which includes the following:

### Chapter 3: General Spillway Design Considerations

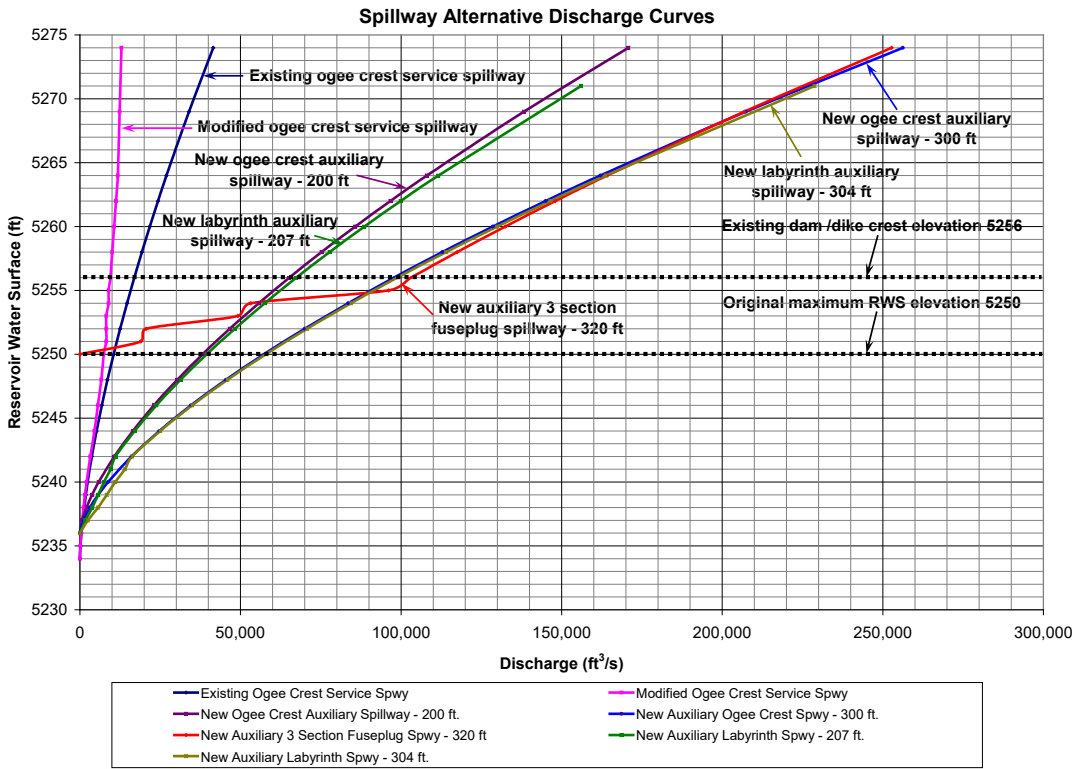
- Section 1. – Pilot channel elevation 5250, 5,000 year flood return period, with crest length equal to or less than 100 feet.
- Section 2. – Pilot channel elevation 5252, 10,000 year flood return period, with crest length equal to or less than 120 feet.
- Section 3. – Pilot channel elevation 5254, 20,000 year flood return period, with crest length equal to or less than 100 feet.
- **Labyrinth weir control structure.** – As with the ogee crest control structure, multiple spillway crest elevations were evaluated resulting in setting the auxiliary spillway crest at elevation 5236, which is two feet above the service spillway crest elevation of 5234 feet. Of note, to take advantage of the hydraulics (i.e., large discharge capacity associated with small hydraulic head), higher crest elevations were evaluated. However, due to limitations with a suitable foundation, higher weir walls would be required which significantly increased the cost and design/construction complexities. Different auxiliary spillway widths ranging from 55 feet to 300 feet were evaluated. It should be noted that the labyrinth spillway width is less than the labyrinth spillway crest length.

Discharge curves were developed for these three types of spillway control structures and are illustrated by the following figure (only a few of the discharge curves of the many sizes of these spillway alternatives are portrayed).

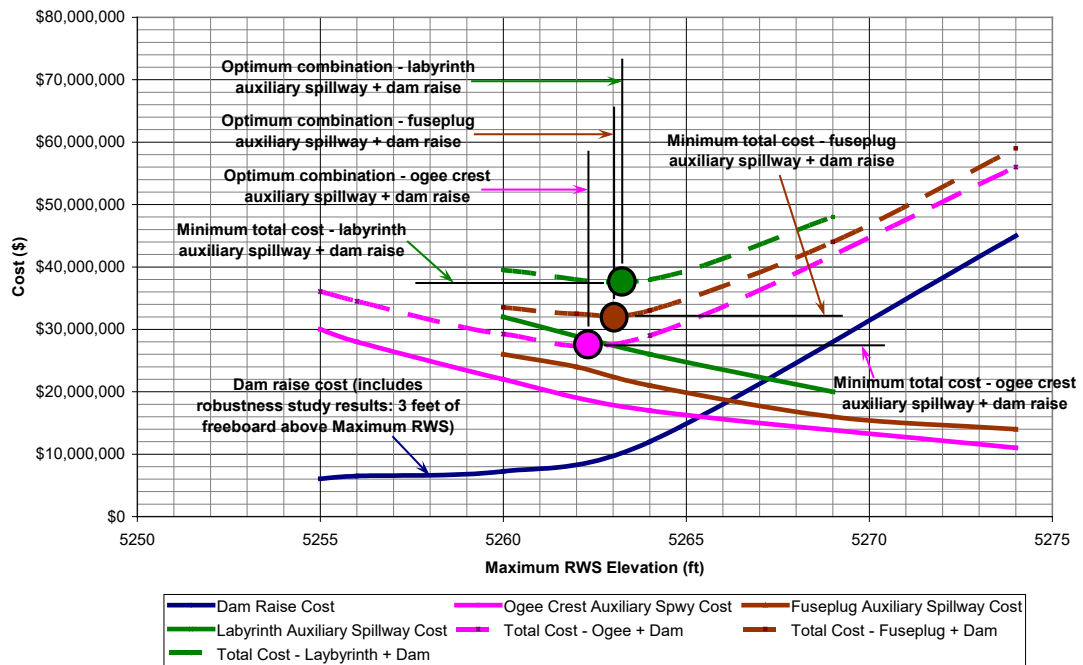
With the discharge curves for size ranges of each spillway control structure and the IDF, flood routings were prepared to determine the maximum RWSs. Additionally, appraisal-level cost estimates were prepared for the auxiliary spillway types/sizes and dam/dike rises. With this information, the second figure was prepared which was used to identify lowest total costs (dam raise plus auxiliary spillway).

From this figure the optimum combination of dam raise and auxiliary spillway type was identified and included (excludes service spillway modification costs which apply to all auxiliary spillway control structures):

# Design Standards No. 14: Appurtenant Structures for Dams (Spillways and Outlet Works)



### Comparative Costs - New Auxiliary Spillway + Dam Raise



- **Auxiliary spillway ogee crest control structure.** – 250-foot crest length with a 9 foot dam/dike raise (includes 3 feet of freeboard above the maximum RWS which was based on a robustness study): Cost was \$28,000,000. There would be a uniform increase in discharge as the hydraulic head (RWS) increases. Also, this type of spillway control structure has considerable reserve discharge capacity.
- **Auxiliary spillway fuseplug control structure.** – Three section embankment (100-foot embankment length with pilot channel elevation 5250; 120-foot embankment length with pilot channel elevation 5252; and 100-foot embankment length with pilot channel elevation 5254) with a 10 foot dam/dike raise (includes 3 feet of freeboard above the maximum RWS which was based on a robustness study): Cost was \$32,000,000. Although the spillway would not operate until very remote flood events occur, there would be very large discharge increases that could increase the possibility of adverse downstream impacts due to rapid rise of river levels.
- **Auxiliary spillway labyrinth weir control structure.** – 235-foot crest length with a 10 foot dam/dike raise (includes 3 feet of freeboard above the maximum RWS): Cost was \$38,000,000. Initially, there would be a fairly large discharge capacity associated with small amount of hydraulic head (above the spillway crest elevation). However, with larger hydraulic heads, this type of spillway control structure has limited reserve discharge capacity.

The auxiliary spillway reinforced concrete ogee crest control structure was ultimately selected. Also, other features included an excavated rock approach channel and a short reinforced concrete conveyance feature (apron) that provided a transition from the ogee crest control structure to the downstream ravine. For more information, the reader is directed to the type and size table, along with the analysis and design table which are part of the *Checklist – Spillway Design Considerations* found in this chapter.



# Example No. 2 – Dam R (New Embankment Dam): Construct New Service Spillway

## Background

Based on planning studies, including exploration and materials testing, a preferred dam site has been selected on a river in Oregon. This dam site is in a rather wide valley with considerable overburden on the valley floor, but limited or no overburden on the valley side slopes. The topography and appraisal-level cost estimates were key factors in determining that Dam R will be an embankment (earthfill) dam. The design requirements include:

- **Total storage capacity** associated with maximum normal RWS (top of active conservation) will be at least 500,000 acre-feet which is associated with RWS elevation 6500. There will be no joint use capacity or exclusive flood storage. The reservoir will provide recreation, irrigation water, sedimentation retention, and municipal and industrial water.
- **The zoned earthfill dam** has a height of at least 300 feet, a crest width of 40 feet, and a crest length of at least 2,500 feet (at the top of active conservation, elevation 6500). The final structural height and crest length will include flood surcharge and freeboard above elevation 6500.
- **Appurtenant structures** are anticipated to include a service spillway and a river (low-level) outlet works. The appurtenant structures will be required to safely accommodate flood events, provide low-level discharge capacity to meet emergency evacuation requirements, and meet normal reservoir operation requirements
- **Existing downstream conditions** include extensive infrastructure (bridges, roads, railroads, water and sanitation services, power grid, etc.), residential, and commercial development, which have limited the safe downstream channel capacity to 20,000 ft<sup>3</sup>/s associated with a complex levee system.

Using the process for selecting the Inflow Design Flood (IDF), detailed in Chapter 2, “Hydrologic Considerations,” in this design standard), a frequency flood equal to or greater than a return period of 25,000 years would result in acceptable total risks<sup>1</sup>. However, the size (peak and volume) of the 25,000 year frequency flood is larger than the current critical PMF size. Since Reclamation’s

---

<sup>1</sup> Acceptable total risks are typically below Reclamation guidelines; however, total risks below guidelines do not ensure that they are always acceptable. Other risk and non-risk factors (uncertainty, confidence, ALARP, cost, physical constraints, etc.) will have a bearing on identifying acceptable total risks. The reader is directed to Chapter 2, “Hydrologic Considerations,” in this design standard, for more details.

## **Design Standards No. 14: Appurtenant Structures for Dams (Spillways and Outlet Works)**

policy is that the PMF is considered the maximum hydrologic loading that can reasonably occur at a given site, the IDF is equated to the current critical PMF. The current critical PMF is a general storm event with a peak inflow of 52,000 ft<sup>3</sup>/s and a 12-day volume of 760,000 acre-feet. This resulted in the baseline total risks being at acceptable levels (i.e., in an area of the f-N chart associated with decreasing justification to take action to reduce risks).

It should be noted that preliminary flood routings were done assuming a range of dam heights to accommodate a range of flood surcharge and various amounts of combined discharge capacity (assuming the use of both the river outlet works and spillway) to assess total risk reduction. Based on preliminary flood routings, it was determined that either the entire flood would be temporarily stored or a combination of discharge capacity and temporarily storing some of the flood would be needed to safely pass the IDF. This consideration is based on not exceeding the downstream safe channel capacity of 20,000 ft<sup>3</sup>/s, which is associated with a complex downstream level system that protects a number of communities. This consideration is somewhat unique, and is being coordinated with the U.S. Army Corps of Engineers. If a cost effective dam and spillway combination can be identified there would be considerable flood damage reduction benefits.

With the selection of the IDF, the spillway location, type, and size are determined which are discussed in the following sections. For more information, the reader is directed to the data table which is part of the *Checklist – Spillway Design Considerations* found in this chapter.

### **Hydraulic Structure Location**

Site-specific conditions and considerations influencing the location of the hydraulic structure(s) include:

- Both dam abutments provide suitable locations for new hydraulic structures. Rock is exposed along the left abutment and there is less than 5 feet of overburden on the right abutment. The left abutment topography is associated with a shallow saddle (depression) that is separated from the dam abutment by a rock knob. Geologic investigations have not located any significant cracks, fractures, and/or shears in the rock and moderately weathered rock (which is considered a suitable foundation) exists several feet below the rock surface. Also, rock jointing is favorable in terms of excavating stable near-vertical slopes on the left abutment, but flatter excavated slopes in the range of ½:1 on the right abutment.



### Chapter 3: General Spillway Design Considerations

- Seismotectonic investigations have determined that there are no active or inactive faults in or near the dam site. The seismic hazard for this dam site is dominated by background or random seismicity. The mean peak horizontal acceleration (PHA) is 0.15 g for the 10,000 year and 0.25 g for the 50,000 year earthquakes.
- The reservoir rim does not provide any suitable locations for a new hydraulic structure. The topography is such that the reservoir rim is very wide and continues to slope upward far above the anticipated RWS. Additionally, drainage areas along the reservoir rim do not feed back into the drainage area associated with the new dam. Finally, there is some residential and commercial development along these drainage areas.
- Hydraulic structures should not be located on or through a new embankment dam unless there are very unusual circumstances, such as no viable location on the dam abutments or reservoir rim. Given this consideration, the hydraulic structures would be located adjacent to or away from the dam abutments.
- Tunneling or cut-and-cover excavation for an underground conveyance feature (tunnel or conduit) through or near the dam abutments or through the reservoir rim was determined to be technically feasible. However, given the much longer distance between portals associated with the right abutment between the river and the reservoir rim, tunneling or cut-and-cover excavation appears more applicable to the left abutment.
- Construction risks can be minimized if a gap (unconstructed portion of the embankment dam) is maintained to pass normal and flood flows during construction. This gap would be maintained until the river outlet works is completed and can be used to pass normal and flood flows during later construction periods when the embankment dam gap is closed. The duration of constructing the river outlet works could be reduced if the spillway is not combined with the outlet works (i.e., is a separate hydraulic structure). A separate spillway would provide construction schedule flexibility in terms of not being affected by the dam or outlet works construction (i.e., not on the critical path).

Given the previously noted site-specific conditions and considerations (and if storing the entire IDF is not pursued), spillway (separate from the outlet works) will be located on or through the left abutment of the dam. Also, depending on the frequency of spillway operation which will be influenced by the combination of reservoir flood storage and spillway discharge, the spillway could be categorized as a service, auxiliary, or emergency hydraulic structure.

## **Design Standards No. 14: Appurtenant Structures for Dams (Spillways and Outlet Works)**

The river outlet works will also be located on or through the lower portion of the left dam abutment. The tunnel or cut-and-cover conduit conveyance feature was evaluated considering cost and constructability considerations. Of note, if the cut-and-cover approach is pursued, the river outlet works conduit will be located in an excavated rock notch or trench, and encased in concrete to isolate it from the dam-foundation contact (at least adjacent to the embankment core or zone 1 material). For more information, the reader is directed to the data table which is part of the *Checklist – Spillway Design Considerations* found in this chapter.

### **Hydraulic Structure Type and Size**

A number of spillway types were eliminated including:

- **Overtopping protection of the dam.** – Based on previously noted site-specific conditions and considerations, the left dam abutment is a viable location for a spillway. Also, overtopping protection of the dam would pose significant and costly engineering/geologic challenges.
- **Fuseplug and fusegate control structures.** – These control structures are associated with large, rapidly increasing discharge capacities. Given the limited safe downstream channel capacity and the significant commercial and residential build-up, a spillway with smaller, more gradual increasing discharge capacity would be more appropriate for this dam site.
- **Gated control structure.** – Appraisal-level costing of gated control structures appear to be fairly expensive given the anticipated smaller discharge capacity for this dam site. Also, the owner (local government) did not want to deal with operation and maintenance (mechanical and electrical) considerations.
- **Side-channel and bathtub control structures.** – These control structures are associated with fairly large discharge capacities. Given the limited safe downstream channel capacity and the significant infrastructure, commercial, and residential build-up, a spillway with smaller discharge capacity would be more appropriate for this dam site.
- **Labyrinth weir control structure.** – Although appraisal-level costing of labyrinth weir control structures appear to be comparable with ogee and/or chute control structures with similar discharge capacities, the added design and construction complexity did not appear to warrant pursuing this control structure type.

### Chapter 3: General Spillway Design Considerations

- **Tunnel inlet control structures.** – These control structures are associated with fairly large increasing discharge capacities. Given the limited safe downstream channel capacity and the significant infrastructure, commercial, and residential build-up, a spillway with smaller discharge capacity would be more appropriate for this dam site.
- **Free overfall control structures.** – This spillway type is not applicable given the dam type and topography.
- **Culverts.** – This spillway type is not suitable given the topography which defines a significant hydraulic head change or drop from the upstream RWS to the downstream tailwater surface.
- **Siphons.** – This spillway type is not suitable given the topography which defines a significant hydraulic head change or drop from the upstream RWS to the downstream tailwater surface. Also, the owner (local government) did not want to deal with operation and maintenance (mechanical and electrical) considerations.

Types of spillways that were further evaluated included:

- **Ogee crest control structure.** – This spillway type is very efficient in terms of large unit discharge capacity and sizable discharge capacity reserve. Also, it is suitable for the topography and geology (all surface features). Maximum discharge should not exceed 17,000 ft<sup>3</sup>/s so that the combined discharge (spillway plus outlet works) does not exceed the safe downstream channel capacity of 20,000 ft<sup>3</sup>/s. As previously noted, the downstream maximum discharge limitation is due to not adversely impacting (failing) the downstream levee system.
- **Chute (open channel or trough) control structure.** – Although not as efficient as the ogee crest control structure, this spillway type is suitable for the topography and geology (all surface features). Similar to the ogee crest control structure, maximum discharge should not exceed 17,000 ft<sup>3</sup>/s so that the combined discharge (spillway plus outlet works) does not exceed the safe downstream channel capacity of 20,000 ft<sup>3</sup>/s.
- **Drop inlet (morning glory) control structure.** – This spillway type has very limited discharge capacity reserve, but is suitable for the topography and geology. Notable differences from the ogee crest and chute spillways, are the drop inlet will have subsurface features (tunnel or conduit) and require a small (surface) footprint. Similar to both the ogee crest and chute control structures, maximum discharge should not exceed 17,000 ft<sup>3</sup>/s so that the combined discharge (spillway plus outlet works) does not exceed the safe downstream channel capacity of 20,000 ft<sup>3</sup>/s.

**Design Standards No. 14: Appurtenant Structures for Dams  
(Spillways and Outlet Works)**

- **No spillway (store IDF).** – Although it is atypical for a storage or multipurpose dam to not include a spillway, there are Reclamation facilities without these hydraulic structures.<sup>2</sup> If there is significant cost savings and sufficient outlet works discharge capacity can be provided to evacuate the flood surcharge in a timely manner, consideration can be given to excluding a spillway for a storage dam. It should be highlighted that constructing a storage or multipurpose dam without a spillway would require a comprehensive quantitative risk analysis and robustness study to evaluate the uncertainties associated with this decision. For more information, the reader is directed to Chapter 2, “Hydrologic Considerations,” in this design standard.

Discharge curves for the three types of spillway control structures and the river outlet works were developed for a range of spillway crest elevations, with the minimum spillway crest elevation being set at the top of active conservation (6500 feet). Flood routings of the IDF were then performed to determine maximum RWSs and spillway crest lengths given that:

- The starting RWS was equal to the top of active conservation elevation 6500.
- The outflow equals inflow, up to discharge capacity.
- In combination with the spillway, the river outlet works was used throughout the flood routings with a discharge capacity of 3,000 ft<sup>3</sup>/s.
- For the no spillway alternative, the river outlet works was used throughout the flood routings.

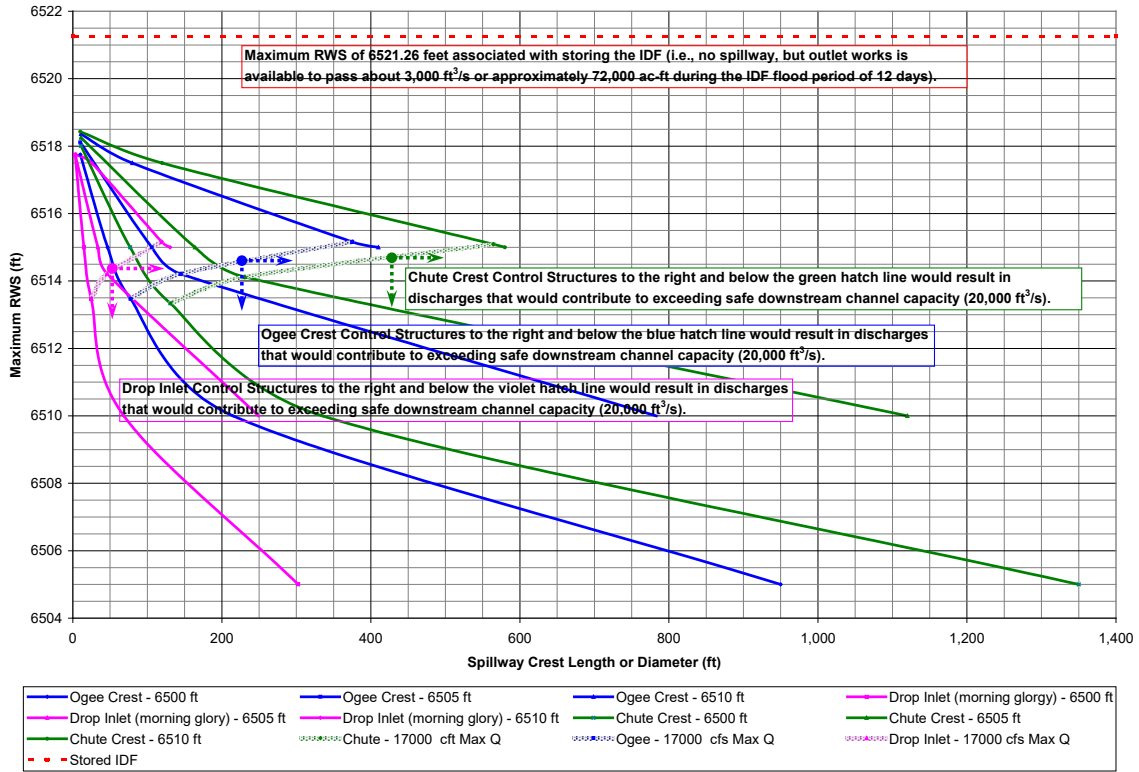
Flood routing results are portrayed in the following figure which compares spillway crest length (for the ogee and chute control structures) and diameter (for the drop inlet) to maximum RWS. The hatched lines for each spillway type that separates spillway crest lengths or diameters and maximum RWSs that would result in exceeding the safe downstream channel capacity (to the right and below the hatched lines). Also, a dashed horizontal line denotes the maximum RWS associated with no spillway, but with a river outlet works. Of note, it was also determined that significant costs (much greater than spillway costs) were associated with the river outlet works having greater discharge capacity than 3,000 ft<sup>3</sup>/s. Therefore, the river outlet works discharge capacity was limited to 3,000 ft<sup>3</sup>/s, which was sufficient to also meet emergency evacuation and construction diversion needs.

---

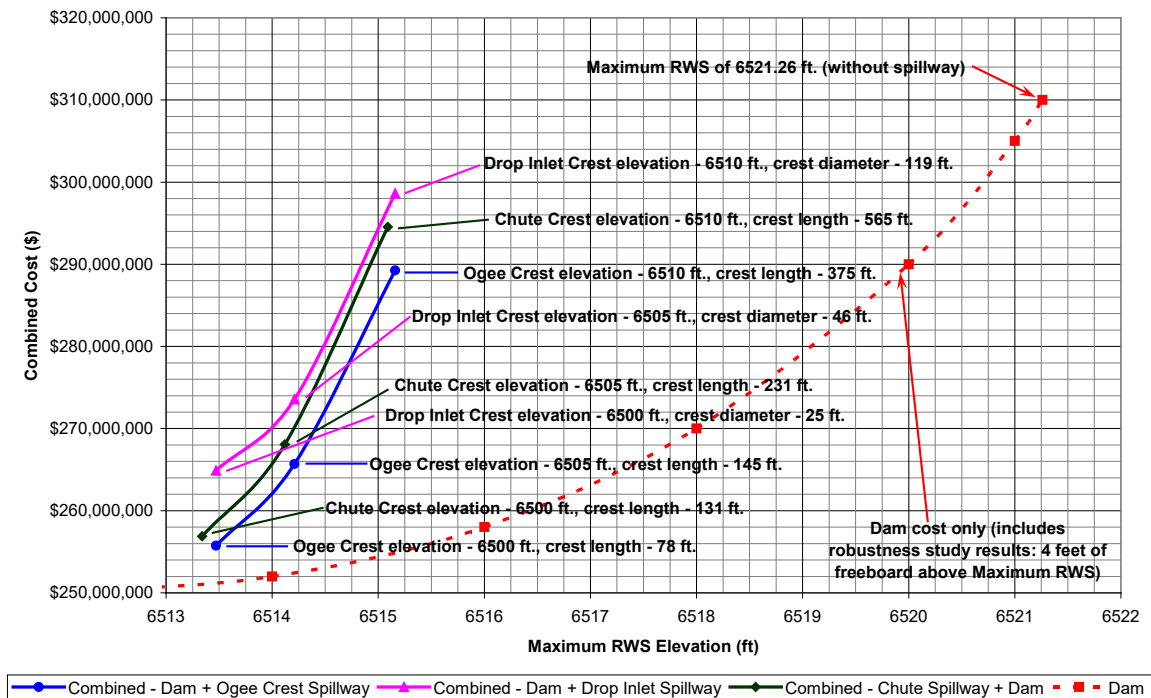
<sup>2</sup> Examples of Reclamation storage or multipurpose dams without spillways include Soldiers Creek Dam (on-stream reservoir) and Ridges Basin Dam (off-stream reservoir).

# Chapter 3: General Spillway Design Considerations

Spillway Alternatives - Crest Length (Ogee or Chute) or Crest Diameter (Drop Inlet) vs. Max. RWS



Comparative Costs - Spillway + Embankment Dam



**Design Standards No. 14: Appurtenant Structures for Dams  
(Spillways and Outlet Works)**

Additionally, appraisal-level cost estimates were prepared for the spillway types and sizes, along with developing cost estimates for dam heights. With this information, the second figure was prepared which was used to identify total appraisal-level costs (dam plus spillway).

From this figure, a combination of dam and spillway type/size cost was identified (excludes the river outlet works costs which apply to all alternatives). Some key observations include:

- **Dam without spillway.** – To temporarily store the entire IDF (excluding the portion of the flood that was passed by the river outlet works), the maximum RWS would reach 6521.26 feet. The dam crest would be set at 6525.25 feet (4 feet of freeboard above the maximum RWS, based on a robustness study). Cost for the dam only is estimated to be \$310,000,000.
- **Dam with spillway.** – Depending on the spillway crest elevation (ranged from 6500 to 6510 feet), the maximum RWS would range from about 6513.5 to 6515.5 feet which would result in a dam crest elevation range of 6517.5 to 6519.5 feet. The combined cost range would be between \$255,700,000 and about \$264,900,000. Based on cost considerations, a spillway will be part of the project.
- **Spillway category.** – The spillways with crest elevations equal to the top of active conservation (6500 feet) would be less costly than spillways with crest elevations set at 6505 or 6510 feet (5 to 10 feet above the top of active conservation). Although setting the spillway crest at 6500 feet would result in more frequent spills, the higher spillway crest elevations would still be subject to fairly frequent operation (i.e., 25-year flood would exceed RWS 6505 feet and less than 100-year flood would exceed RWS 6510 feet). Given the cost and frequency of operation, the spillway crest elevation is set at 6500 feet and the hydraulic structure is categorized as a service spillway.
- **Spillway type and size.** – The three spillways, each with a crest elevation of 6500 feet, include:
  - Ogee crest. – Crest length of 78 feet, maximum discharge of 17,000 ft<sup>3</sup>/s, maximum RWS of 6513.5 feet, dam crest elevation of 6517.5 feet, and estimated spillway cost of \$5,850,000.
  - Drop inlet. – Crest diameter of 25 feet, maximum discharge of 17,000 ft<sup>3</sup>/s, maximum RWS of 6513.5 feet, dam crest elevation of 6517.5 feet, and estimated spillway cost of \$15,000,000.

### Chapter 3: General Spillway Design Considerations

- Chute. – Crest length of 131 feet, maximum discharge of 17,000 ft<sup>3</sup>/s, maximum RWS of 6513.3 feet, dam crest elevation of 6517.3 feet, and estimated spillway cost of \$7,860,000.

The service spillway reinforced concrete ogee crest control structure was ultimately selected. Considerations included least cost and fairly straightforward design and construction. Other features associated with the control structure included an excavated rock approach channel, a reinforced concrete conveyance feature (chute), a terminal structure (hydraulic-jump stilling basin), and a riprapped-lined exit channel that provided a transition from the terminal structure to the downstream river. For more information, the reader is directed to the type and size table, along with the analysis and design table which are part of the *Checklist – Spillway Design Considerations* found in this chapter.





## Example No. 3 – Dam Q (New Concrete Dam): Construct New Service Spillway

### Background

Based on planning studies, including exploration and materials testing, a preferred dam site has been selected on a river in Arizona. This dam site is in a steep walled, fairly narrow canyon with limited overburden on the canyon floor and no overburden on the canyon walls. Based on the site topography, geology, materials testing, and appraisal-level cost estimates, it was determined that Dam Q will be a concrete (curved gravity roller compacted concrete, RCC) dam. The design requirements include:

- **Total storage capacity** associated with the maximum normal RWS (top of active conservation, elevation 1900) will be at least 898,100 acre-feet. There will be no joint use capacity or exclusive flood storage. The reservoir will provide recreation, irrigation water, sedimentation retention, and municipal and industrial water.
- **Maximum RWS** is limited to, at, or below elevation 1925 due to significant infrastructure (roads, bridges, railroads) at and above elevation 1930 along the reservoir rim.
- **The RCC curved gravity dam** has a height of at least 550 feet, a crest width of 40 feet, and a crest length of at least 1,500 feet (based on the top of active conservation, elevation 1900). The final structural height and crest length will include flood surcharge and freeboard.
- **Appurtenant structures** are anticipated to include a service spillway, a river (low-level) outlet works, and powerplant. The river outlet works and the power penstocks will be a combined feature and provide low-level discharge capacity to meet emergency evacuation requirements, provide flow for power generation, and meet normal reservoir operation requirements. Given the small discharge capacity, neither the river outlet works nor powerplant will be used to accommodate flood events.
- **Existing downstream conditions** include another Reclamation dam located less than 5 miles downstream. Also, there is very limited infrastructure, residential, and commercial development along this river reach. However, there are large numbers of recreationalists on and near the downstream reservoir during much of the year. The safe downstream channel capacity will be governed by not exceeding the peak inflow of the Inflow Design Flood (IDF) (i.e., the outflow hydrograph from this dam site is equal to or smaller than the inflow hydrograph).

## **Design Standards No. 14: Appurtenant Structures for Dams (Spillways and Outlet Works)**

Using the process for selecting the Inflow Design Flood (IDF), detailed in Chapter 2, “Hydrologic Considerations,” in this design standard), a frequency flood equal to or greater than a return period of 100,000 years would result in acceptable total risks. The size (peak and volume) of the 100,000 year frequency flood approximates the current critical PMF size. Since Reclamation’s policy is that the PMF is considered the maximum hydrologic loading that can reasonably occur at a given site, the IDF is equated to the current critical PMF. The current critical PMF is a rain-on-snow storm event with a peak inflow of 160,700 ft<sup>3</sup>/s and a 15-day volume of 778,130 acre-feet. This resulted in the baseline total risks being at acceptable levels (i.e., in an area of the f-N chart associated with decreasing justifications to take action to reduce risks).

It should be noted that preliminary flood routings were done assuming a range of dam heights to accommodate a range of flood surcharge and various amounts of discharge capacity to assess total risk reduction. It was determined that it would not be feasible to temporarily store the entire IDF due to the cost and technical challenges associated with an extremely high dam (over 660 feet, which would exceed the maximum RWS limitation of 1925 feet). Therefore, a combination of discharge capacity and temporarily storing some of the flood would be needed to safely accommodate the IDF, which would reduce the height of the dam (550 feet, which is associated with a crest elevation of 1925 feet).

With the selection of the IDF, the spillway location, type, and size are determined which are discussed in the following sections. For more information, the reader is directed to the data table which is part of the *Checklist – Spillway Design Considerations* found in this chapter.

### **Hydraulic Structure Location**

Site-specific conditions and considerations influencing the location of the hydraulic structure(s) include:

- Both dam abutments provide suitable locations for subsurface (underground) new hydraulic structures. Rock is exposed along both abutments; however, considerable excavation comparable to tunneling would be required for a surface-type spillway. Geologic investigations have not located any significant cracks, fractures, and/or shears in the rock, and moderately weathered rock (which is suitable for a structural foundation) is near the exposed rock surfaces. Also, rock jointing is favorable in terms of tunneling through either abutment.

### Chapter 3: General Spillway Design Considerations

- Seismotectonic investigations have determined that there are no active or inactive faults in or near the dam site. The seismic hazard for this dam site is dominated by a single fault source approximately 50 miles away. The mean PHA is 0.2 g for the 10,000 year and 0.45 g for the 50,000 year earthquakes.
- One area along the left reservoir rim, approximately one mile from the dam site, does provide a suitable location for a new hydraulic structure. The topography and geology are favorable for either a surface (chute conveyance feature) or subsurface (tunnel conveyance feature) hydraulic structure. Also, any releases from this site would not impact infrastructure, residential or commercial developments and re-enter the river (associated with the dam site) approximately one-half mile downstream of the dam site.
- Hydraulic structures can be located on or through a new concrete dam if there are favorable cost and technical considerations (such as the ability to effectively armor the abutments and foundation to mitigate erosion due to overtopping releases). Of note, from a cost standpoint, it would be very advantageous to locate the powerplant at the base of the dam opposed to locating the powerplant downstream on the canyon walls. If the powerplant is located at the base of the dam, space limitations will exist for a spillway located on or through the concrete dam (i.e., about one-half of the dam crest length or at least 750 feet would be available for a spillway). Similar space limitations exist at the reservoir rim site (i.e., hydraulic structure is limited to about 750 foot wide or less).
- Tunneling excavation for an underground conveyance feature through the dam abutments or through the reservoir rim was determined to be technically feasible. Both dam abutments could accommodate a relatively short tunnel around the dam site (less than 1000 feet). If a tunnel spillway is pursued, it could initially serve as a diversion feature by including a second low level tunnel (below the spillway tunnel portal) that would extend from the reservoir to the lower portion of the spillway tunnel. Once the dam has been constructed, the low-level tunnel can be plugged.
- Construction risks can be minimized if floods passing through the dam site do not increase baseline risks associated with the downstream Reclamation dam (i.e., do not transfer additional risks to the downstream dam during construction). This could occur if flood-induced failure of a diversion system (such as overtopping failure of an embankment cofferdam) resulted in a larger breach hydrograph than the inflow hydrograph leading to the downstream dam not being able to safely

## Design Standards No. 14: Appurtenant Structures for Dams (Spillways and Outlet Works)

accommodate the breach flood. Based on frequency flood routings, it was determined that flood-induced failure of an embankment cofferdam would not transfer risk to the downstream dam if the diversion system was designed to safely accommodate frequency floods with return periods equal to or less than 500 years. This consideration may have a bearing on the location and sizing of the river outlet works, as well as the timing of constructing the river outlet works. As an alternative to diverting river flows through a low-level tunnel or to augment discharge capacity of a low-level tunnel diversion system, an evaluation will be made of constructing the conveyance portion of the river outlet works across the construction site (dam footprint). After flows are diverted to the river outlet works conveyance feature, and perhaps through the low-level diversion tunnel, construction of the dam will begin. Additionally, a separate spillway (not combined with the river outlet works) would provide construction schedule flexibility in terms of not being affected by the dam or river outlet works construction (i.e., not on the critical path).

Given the previously noted site-specific conditions and considerations, a new spillway (separate from the river outlet works) will be located on or through the dam, through the dam abutments, or on or through the left reservoir rim. Also, depending on the frequency of spillway operation which will be influenced by the combination of reservoir flood storage and spillway discharge, the spillway could be categorized as a service, auxiliary or emergency hydraulic structure. For more information, the reader is directed to the data table which is part of the *Checklist – Spillway Design Considerations* found in this chapter.

### Hydraulic Structure Type and Size

A number of spillway types were eliminated including:

- **Overtopping protection of the dam.** – Based on previously noted site-specific conditions and considerations, it would be very advantageous from a cost standpoint to locate the powerplant at the base of the dam opposed to locating the powerplant downstream on the canyon walls. With the powerplant located at the base of the dam, allowing the dam to overtop during flood events could lead to significant damage to the powerplant.
- **Drop inlet.** – This spillway type would typically be associated with very limited discharge reserve, and a much larger (in elevation) dam to accommodate increased flood surcharge.

### Chapter 3: General Spillway Design Considerations

- **Free overfall control structures.** – This spillway type would be applicable for the dam type and topography, but with the location of the powerplant at or near the base of the dam, operating the spillway could lead to damage of the powerplant due to the free (flow) jet passing over or adjacent to the powerplant. It would be expected that additional features to protect the powerplant during spillway operations would be incorporated into the design and construction, which would increase cost.
- **Chute (stepped chute).** – This spillway type would be applicable for the dam type and dam geometry, but the anticipated large unit discharge would minimize the energy dissipation effectiveness of the steps, along with increased cavitation potential due to the anticipated high flow velocities over the steps.
- **Culverts.** – This spillway type is not suitable given the topography which defines a significant hydraulic head change or drop from the upstream RWS to the downstream tailwater surface. Additionally, there is very limited discharge reserve for this spillway type.
- **Siphons.** - This spillway type is not suitable given the topography which defines a significant hydraulic head change or drop from the upstream RWS to the downstream tailwater surface. Also, this spillway type is associated with very limited discharge capacity and discharge reserve.
- **No spillway (store IDF).** – Based on previously noted site-specific conditions and considerations, a significantly higher dam would be required to temporarily store the IDF (over 660 feet without a spillway versus up to 550 feet with a spillway). A much higher dam would result in significantly larger costs and exceed the maximum RWS limitation of 1925 feet.

Types of spillways that were further evaluated include:

- **Ogee crest control structure (at the dam and reservoir rim sites).** – This spillway type is efficient in terms of large unit discharge capacity and sizable discharge capacity reserve. Also, it is suitable for the topography and geology (all surface features) at the reservoir rim site, or part of the tunnel inlet structure through the dam abutment, or on the dam in combination with a chute conveyance feature on the downstream face of the dam (chute would direct flows by and away from the downstream powerplant).

**Design Standards No. 14: Appurtenant Structures for Dams  
(Spillways and Outlet Works)**

- **Gated tunnel inlet control structures.** – It is anticipated that fairly large discharge capacities would be needed, which can be provided by this type of spillway. This spillway type would have a very small (surface) space requirement and could provide effective and efficient diversion capabilities by including a second low-level diversion tunnel connecting the reservoir to the lower portion of the spillway tunnel. Also, a gated tunnel inlet spillway would separate (isolate) dam construction activities from the spillway construction activities.
- **Fuseplug and fusegate control structures (at the reservoir rim site).** – These control structures are associated with large, rapidly increasing discharge capacities. This spillway type is suitable for the topography and geology (all surface features) at the reservoir rim site. Based on previously noted site-specific conditions and considerations, there is limited infrastructure, residential, and commercial development between this dam site and an existing downstream Reclamation dam. Also, it would be expected that limited or no recreational usage would be occurring on or near the downstream Reclamation reservoir during a flood event, so the rapidly increasing releases associated with fuseplug or fusegate spillway would be expected to have limited or no adverse impacts.
- **Gated (ogee or various shaped weirs) control structure (at the dam site).** – This spillway type is very efficient in terms of larger unit discharge capacity and sizable discharge capacity reserve (if gates can be raised above the water surface over the ogee crest). Also, there is more control of flood releases. Although this spillway type would be suitable for the topography and geology (all surface features) at the reservoir rim site or part of the tunnel inlet structure through the dam abutment, appraisal-level cost estimates suggest considerable cost savings if it is located on the dam. Finally, this spillway type is suitable to be located on the dam in combination with a chute conveyance feature on the downstream face of the dam (chute would direct flows by and away from the downstream powerplant).
- **Side-channel and bathtub control structures (at the dam and reservoir rim sites).** – These control structures are associated with fairly large discharge capacities and would be suitable for the topography and geology (all surface features) at reservoir rim site or part of the tunnel inlet structure through the dam abutment. These control structures would not be suitable for locating them on the dam given space and geometry limitations. Although these type of control structures would be more expensive than comparable ogee crest and chute control structures, cost savings may be realized with narrower conveyance features and terminal structures.

- **Labyrinth weir control structure (at the reservoir rim site).** – This control structure is associated with fairly large discharge capacities due to small hydraulic heads (i.e., depth of flow over the spillway crest) across the width of the spillway. It should be noted that the hydraulic efficiency is lost if hydraulic heads get large (would act like a broad crested weir). This spillway type would be suitable for the topography and geology (all surface features) at the reservoir rim site. Also, this control structure would not be suitable for locating them on the dam given space and geometry limitations.

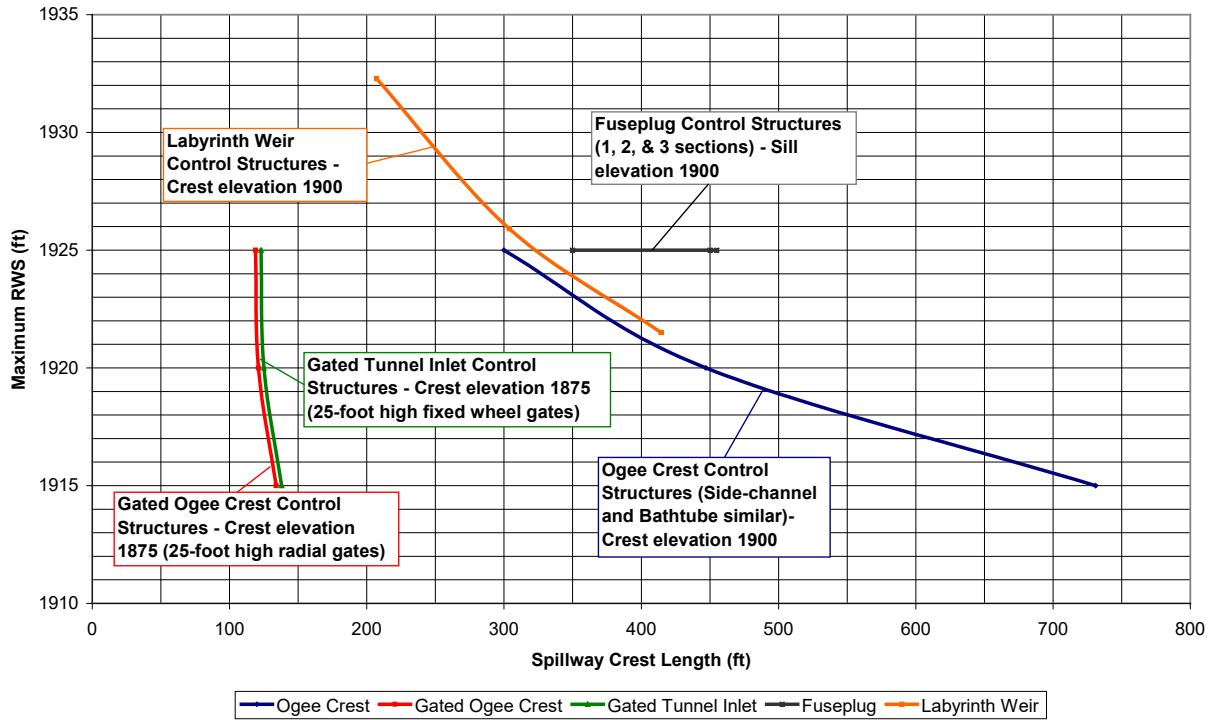
Discharge curves for the six types of spillways were developed for a range of spillway crest elevations, with the minimum crest elevation being set at the top of active conservation (1900 feet). Flood routings of the IDF were then performed to determine maximum RWSs and spillway crest lengths given that:

- The starting RWS was equal to the top of active conservation elevation 1900.
- The outflow equals inflow, up to the discharge capacity of the spillway.

Flood routing results are portrayed in the following figure which compares spillway crest length to maximum RWS for the different spillway types. From these flood routings, it was determined that all but the gated ogee crest and the gated tunnel inlet spillways have crest elevations equal to the top of active conservation, elevation 1900. The gated ogee crest and the gated tunnel inlet control structures are set at elevation 1875 to accommodate 25-foot high (or larger) radial and wheel-mounted gates (top of gates are at or above the top of active conservation). It should be highlighted that all spillways except the fuseplug spillway are categorized as service spillways. Through an iterative process, the fuseplug spillway was sized so that the maximum RWS did not exceed elevation 1925. This resulted in setting the pilot channels above the top of active conservation such that a remote frequency flood event would initiate operation of an embankment section of the fuseplug. Specifically, the 1,000 year flood would initiate operations for a pilot channel elevation of 1905 feet (1 section fuseplug); the 5,000 year and 10,000 year floods would initiate operations for pilot channel elevations of 1910 and 1912 feet, respectively (2 section fuseplug); and the 5,000, 10,000, and 25,000 year floods would initiate operations for pilot channel elevations of 1910, 1912 and 1916 feet, respectively (3 section fuseplug).

## Design Standards No. 14: Appurtenant Structures for Dams (Spillways and Outlet Works)

Spillway Alternatives - Crest Length (Ogee, Side-channel, Bathtub, Chute, Chute, Fuseplug & Labyrinth Weir) vs. Max. RWS



Additionally, appraisal-level cost estimates were prepared for the spillway types and sizes, along with developing cost estimates for dam heights. With this information, the second figure was prepared which was used to identify total appraisal-level costs (dam plus spillway).

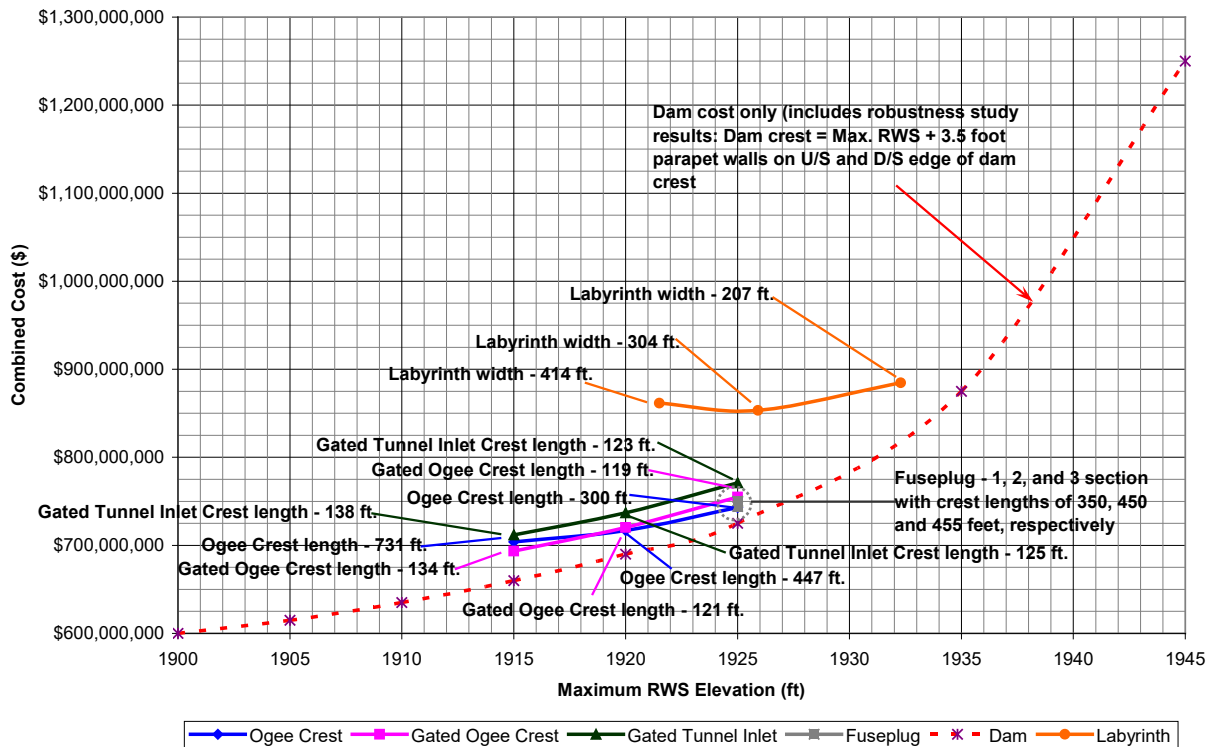
From this figure a combination of dam and spillway type/size appraisal-level cost was identified (excludes the river outlet works and powerplant costs which apply to all alternatives). Some key observations include:

- Maximum RWS.** – For all spillway types except for the fuseplug and labyrinth weir spillways, combined costs (dam plus spillway) are minimized for a maximum RWS of 1915 feet.
- Spillway category.** – The least cost spillway types (ogee crest, gated tunnel inlet, and gated ogee crest) are considered to be service spillways (crest elevations are equal or less than the top of active conservation, elevation 1900).



## Chapter 3: General Spillway Design Considerations

### Comparative Costs - Spillway + Concrete Dam



- **Spillway type and size.** – The six spillways evaluated include (presenting only minimum cost for each spillway type):
  - Ogee crest. – Crest length of 731 feet, maximum discharge of 156,500 ft<sup>3</sup>/s, maximum RWS of 1915 feet, dam crest elevation of 1915 feet plus 3.5 foot parapet wall, and estimated combined cost is \$703,000,000 (\$43,000,000 for the spillway and \$660,000,000 for the dam).
  - Gated ogee crest. – Crest length of 135 feet (three 45 foot wide by 25-foot high radial gates), maximum discharge of 143,200 ft<sup>3</sup>/s, maximum RWS of 1915 feet, dam crest elevation of 1915 feet plus 3.5 foot parapet wall, and estimated combined cost is \$693,500,000 (\$33,500,000 for the spillway and \$660,000,000 for the dam).
  - Gated tunnel inlet. – Crest length of 138 feet (three 46 foot wide by 25-foot high fixed-wheel gates), maximum discharge of 142,500 ft<sup>3</sup>/s, maximum RWS of 1915 feet, dam crest elevation of 1915 feet plus 3.5 foot parapet wall, and estimated combined cost is \$711,750,000 (\$51,750,000 for the spillway and \$660,000,000 for the dam).

**Design Standards No. 14: Appurtenant Structures for Dams  
(Spillways and Outlet Works)**

- Fuseplug. – Three embankment sections (Total crest length of 350 feet with three sections lengths of 100 feet, 120 feet, and 130 feet; Pilot channel elevations of 1910 feet, 1912 feet, and 1916 feet), maximum discharge of 150,500 ft<sup>3</sup>/s, maximum RWS of 1925 feet, dam crest elevation of 1925 feet plus 3.5 foot parapet wall, and estimated combined cost is \$744,250,000 (\$19,250,000 for the spillway and \$725,000,000 for the dam).
- Labyrinth weir. – Crest length of 414 feet, maximum discharge of 150,700 ft<sup>3</sup>/s, maximum RWS of 1921.5 feet, dam crest elevation of 1921.5 feet plus 3.5 foot parapet wall, and estimated combined cost is \$861,600,000 (\$31,100,000 for the spillway and \$830,500,000 for the dam).
- Fusegate. – Given the costs associated with the fuseplug and labyrinth weir spillways, the fusegate spillway was anticipated to not be the least cost spillway type and therefore layouts, flood routings, and cost estimate were not prepared for this spillway type.
- Side-channel and bathtub. – Layouts and flood routings were not prepared for these spillway types; however, crest lengths, maximum discharges and maximum RWSs would be similar to the ogee crest spillway type. Also, the overall costs were assumed to be similar to the ogee crest spillway type (i.e., Costs for the side-channel and bathtub spillway type would be more expensive for the control structure, but less expensive for the conveyance feature and terminal structure than associated with the ogee crest spillway type).

The service spillway will be a reinforced concrete gated tunnel inlet control structure. It will be located through the dam right abutment away from the powerplant which is located on the dam toe near the left abutment. To minimize the control structure footprint, three 46-foot wide by 25-foot high wheel-mounted gates will be located on an curved ogee crest. The tunnel inlet square shape will transition to a 50-foot diameter concrete lined tunnel approximately 50 feet downstream of the entrance portal, then transition to a 40-foot diameter concrete lined tunnel approximately 150 feet downstream of the entrance portal. An aeration slot (to mitigate cavitation potential) will be located approximately 200 feet downstream of the entrance portal. The tunnel conveyance feature will continue approximately 800 feet downstream of the entrance portal to the exit portal and a flip bucket energy dissipator that will direct releases considerably downstream of the dam toe (Note: there is sufficient tailwater depth to dissipate the kinetic energy of the spillway releases without erosion of the downstream river channel). Considerations that resulted in selecting the gated tunnel inlet included:

### Chapter 3: General Spillway Design Considerations

- Cost which is more than the gated ogee crest and straight ogee crest alternatives; however, there are cost reducing considerations associated with diversion through the lower portion of the tunnel, which are not estimated at this time, but are anticipated to offset the cost difference between this alternative and the two less expensive alternatives.
- This spillway type provides considerable discharge capacity.
- Separating the spillway from the dam construction will allow overlapping construction of the dam and spillway, which will reduce the overall construction period.
- The gated control structure will provide significant control associated with reservoir operations.

For more information, the reader is directed to the type and size table, along with the analysis and design table which are part of the *Checklist – Spillway Design Considerations* found in this chapter.



## **Appendix B**

### Potential Failure Modes (PFMs) for Spillways



# Potential Failure Modes (PFMs) for Spillways

Quantitative risk analysis methodology will be part of evaluating, analyzing, and designing existing spillway modifications and new spillways. To facilitate the effort of identifying and evaluating PFMs, a list of typical PFMs associated with spillways and grouped by loading conditions (Static, Hydrologic, and Seismic) is summarized in the following text.

## Static (Normal Operations) PFMs

These static PFMs are not applicable when the spillway is being operated to pass flood events and/or the RWS exceeds the maximum normal RWS (either top of active conservation or top of joint use, whichever is higher in elevation).

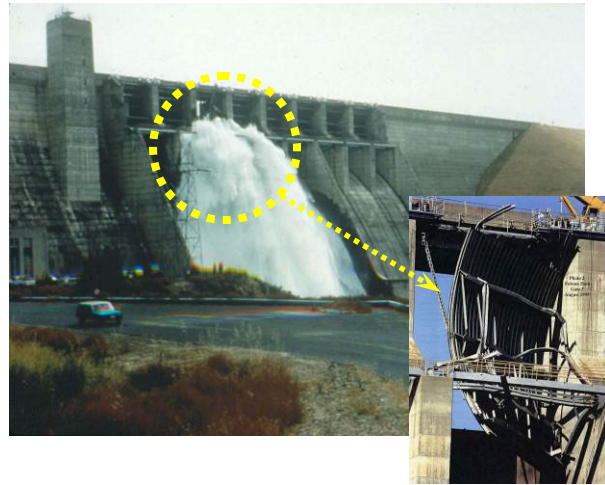
- **Internal erosion.** – The reservoir is at or below the maximum normal RWS. Seepage flows could increase over time through flaws or discontinuities in the fill material adjacent to the spillway control structure and/or conveyance feature (either chute or conduit), through cracks or joint openings in the spillway, in the foundation, or a combination. Seepage velocities could be sufficient to carry soil material, enlarging the discontinuities until a continuous conduit/pipe develops. Internal erosion would continue, eventually leading to a collapse of the conduit/pipe, eroding of the fill material adjacent to the spillway and/or foundation, which would end with uncontrolled release of the reservoir.



**1965 Dam Internal Erosion Incident adjacent to Spillway during Normal Operations – Fontenelle Dam, Wyoming.**

**Design Standards No. 14: Appurtenant Structures for Dams  
(Spillways and Outlet Works)**

- **Gate failure.** – During normal operations of passing non-flood flows and/or testing spillway gates, one or more of the gates fail and are displaced downstream (in the case of radial or wheel-mounted gates) or lower (in the case of drum and crest gates). If the RWS exceeds the spillway crest, an uncontrolled release of a portion of the reservoir results (it should be noted that the level of release may not exceed safe downstream channel capacity and cause downstream consequences). Based on case histories, gate failures are due to mechanical failures (such as the 1997 rapid lowering of Pacific Gas and Electric Company's Cresta Dam drum gate due to failure of the drain line and at least one check valve to function properly) or structural failures (such as the 1995 collapse and partial displacement of a tainter gate at Reclamation's Folsom Dam. This was due to excessive friction at the trunnion leading to failure of steel gate supports, or the 1992 rockfall damaging Reclamation's Horse Mesa radial gates and control structure).



**1995 Spillway Tainter (Radial) Gate Failure during Normal Operations – Folsom Dam.**



**1992 Spillway Gate Damage due to Rockfall – Horse Mesa Dam, Arizona**

- **Reinforced concrete structural failure.** – Reinforced concrete features (walls, slabs, conduits, tunnels, etc.) fail as a result of normal loading in combination with one or more deterioration mechanisms acting on the reinforced concrete and/or foundation over time. The root-causes tend to be the loss of the material and strength properties of the reinforced concrete and/or foundation, along with removal of concrete and/or foundation. Of note, there is no one generic failure or incident event tree associated with reinforced concrete deterioration. Rather, the effects are typically reflected in the likelihood of events occurring for other potential



failure or incident modes, such as the likelihood (probability) of open joints, offsets, surface irregularities, cracks and spalls. Types of deterioration mechanisms that have been experienced include<sup>1</sup>:

○ **Freeze-thaw deterioration and/or frost-heave**

**deterioration.** – Of greatest concern is the accumulation of water in soils adjacent to spillway features (such as walls or floor slabs), which then freeze and result in large stresses on the features which is termed frost-heave. An

example was the frost-heave induced failure of the spillway control structure side walls at

the Turtle Mountain Indian Reservation’s Belcourt Dam. Both spillway control structure walls had succumbed (concrete walls had cracked and reinforcement had yielded) due to frost-heave. The displacement of the walls had created a seepage path along the interface of the walls and the adjacent embankment dam which could lead to internal erosion and uncontrolled release of the reservoir. To mitigate this potential failure mode, the existing spillway control structure was replaced in 2010.

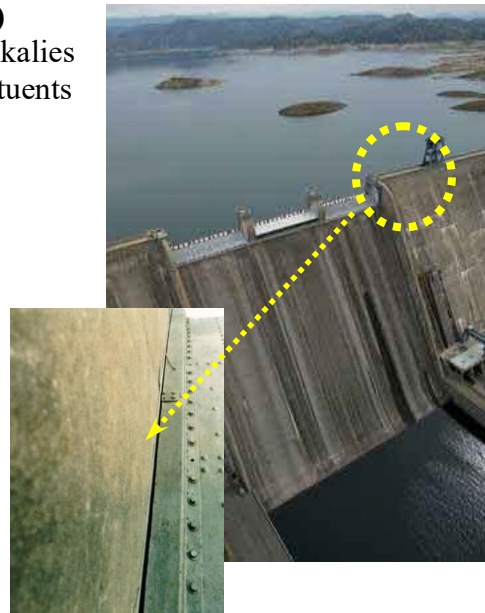


**Spillway Walls Fail (concrete walls crack near base and reinforcement yields) due to Frost-Heave – Belcourt Dam, North Dakota**

<sup>1</sup> Reference: “The Evolution of Durable Concretes – A Time-line for the Bureau of Reclamation,” April 26, 2001.

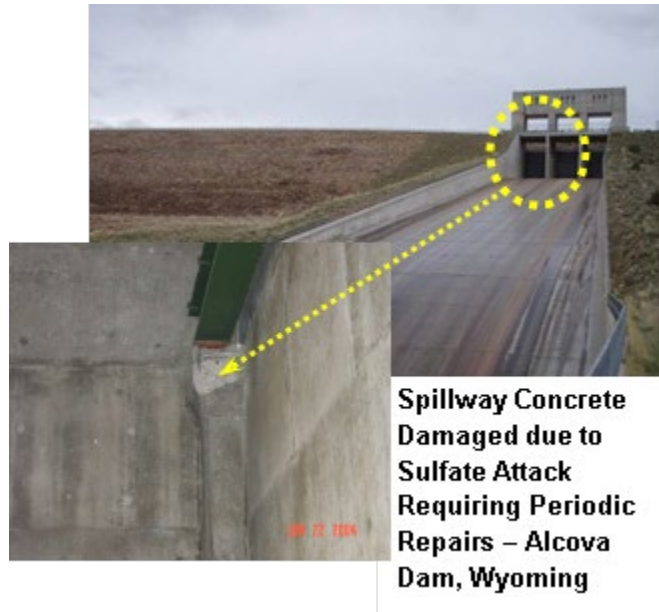
**Design Standards No. 14: Appurtenant Structures for Dams  
(Spillways and Outlet Works)**

○ **Alkali-silica-reaction (ASR) deterioration.** – As a result of alkalis in the cement and mineral constituents of some aggregates (opal and some volcanic rocks), a chemical reaction can occur resulting in large scale, excessive internal and overall expansion (cracking of the cement paste and aggregate). An example was the periodic binding of the drum gates due to the ASR-induced expansion of spillway concrete end blocks at Reclamation’s Friant Dam. These drum gates were eventually replaced by Obermeyer crest gates that accommodated continued expansion of the spillway end blocks.



**Spillway End Blocks Expanding and Binding Drum Gates due to ASR – Friant Dam, California**

○ **Sulfate deterioration.** – As a result of some salts (sodium, magnesium, and calcium) primarily found in soils and ground water in the western United States, a chemical reaction can occur with the cement paste (hydrated lime and hydrated calcium aluminate) which leads to considerable expansion and disruption (cracking) of the cement paste. An example is the periodic repairs of the spillway at one of Reclamation’s dams. The repairs focus on surface cracking and spalling due to sulfate attack. In this case, there could be multiple deterioration mechanisms including sulfate attack, freeze thaw, and thermo-expansion/contraction.

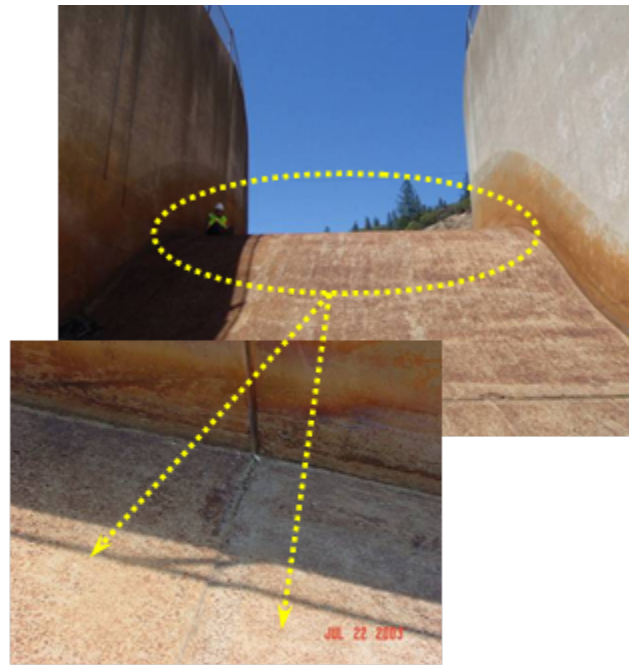


**Spillway Concrete Damaged due to Sulfate Attack Requiring Periodic Repairs – Alcovia Dam, Wyoming**

### Chapter 3: General Spillway Design Considerations

- **Acid deterioration.** – Primarily due to mining operations, very high acid concentrated releases can enter a reservoir and significantly lower the pH of the water.

The water can react with a concrete structure and result in “softening” (dissolving) the concrete paste (sand and cement). An example is the softening and loss of the concrete paste along spillway flow surfaces at Reclamation’s Spring Creek Debris Dam. During releases the concrete flow surface reacted with the water which had a very low pH due to mine effluent that accumulated in the reservoir, Designs were initiated to replace the spillway, but the mine owners elected to install water treatment upstream of the reservoir to treat the mine effluent.



**Spillway Concrete Damaged due to Acid Attack which Removed Concrete Past, Exposing Aggregate on the Floor Flow Surface – Spring Creek Debris Dam, California.**

- **Chloride (corrosion) deterioration.** – As a result of exposing reinforcement to the atmosphere, corrosion can take place that will eventually result in loss of strength properties and potential compromise of the reinforcement. Exposure of the reinforcement can result from other deterioration mechanisms such as freeze thaw, ASR, sulfate attack, and thermo-expansion/contraction. An example was the south spillway headwall at Reclamation’s Guernsey Dam, which likely lost concrete cover over the reinforcement due to freeze thaw deterioration mechanism. Repairs are planned for 2013 and 2014.

**Design Standards No. 14: Appurtenant Structures for Dams  
(Spillways and Outlet Works)**

- **Thermo-expansion/contraction.** – Due to radiate heat, concrete surfaces expand and may result in very large compressive stresses that tend to focus at or near contraction and/or control joints. These compressive stresses can result in cracking/spalling near the joints. An example was the thermo-induced damage (cracking or spalling) of the spillway concrete floor slab transverse control joints at Reclamation’s Deer Creek Dam.



**Spillway Chute Damage due to Thermo-expansion/contraction—Deer Creek Dam, Utah**



A 2007 concrete overlay was placed over the existing spillway floor slab which included surface blockouts at the joints that would accommodate expansion without creating high near-surface stresses leading to cracking/spalling.

- **Loss of foundation (differential settlement).** – Foundation loss can be due to internal erosion and/or settlement that results in diminished support of the overlying spillway, which could lead to structural failure (collapse) of the spillway features. An example is the seepage-induced spillway foundation loss at one of Reclamation’s dams. Emergency modifications were undertaken in 2003 to re-establish the spillway foundation which would mitigate the internal erosion potential and provide support for the spillway.



**Loss of Foundation beneath Spillway Chute due to Internal Erosion – Reclamation dam.**

Additionally, portions of the reinforced concrete conveyance feature (chute) were removed and replaced with defensive design measures such as water stops across flow surface transverse control joints, longitudinal reinforcement extending across the transverse control joints; and filtered underdrains.



## Hydrologic (flood-induced) PFMs

These hydrologic PFMs are applicable when the spillway is being operated to pass flood events and/or the RWS exceeds the maximum normal RWS (either top of active conservation or top of joint use, whichever is higher).

- **Dam overtopping.** – Overtopping of a dam, dike and/or low area (saddle) on the reservoir rim occurs when a flood event overwhelms flood surcharge storage and discharge capacity of the appurtenant structures (such as a spillway). For an embankment dam, dike, or saddle on the reservoir rim, if the depth and duration of overtopping is sufficient,



**1964 Dam Remnant after Flood-induced Overtopping Failure – Lower Two Medicine Dam, Montana.**

erosion will result, which could lead to breach and uncontrolled release of the reservoir. For a concrete dam, if the depth and duration of the overtopping is sufficient to erode abutments and/or foundation leading to the undermining and destabilizing of the dam, breaching (due to downstream displacement) of the dam could occur leading to uncontrolled release of the reservoir. An additional consideration for dam and dike overtopping is the potential concentration of flow along the groins (abutment contacts between the dam/dike and the foundation). An example was the 1964 flood-induced overtopping failure of the Bureau of Indian Affairs' Lower Two Medicine Dam. This failure resulted from insufficient flood surcharge capacity and lacking spillway discharge capacity. The dam and appurtenant structures were reconstructed in 1967.

- **Elevated RWS (non-overtopping of dam) resulting in internal erosion.** – Flood-induced internal erosion of fill material along the spillway features, in the foundation, or combination, which would result from the RWS being substantially elevated above normal operations and/or what may have historically been experienced (i.e., first filling conditions exist). The elevated RWS would typically be above the maximum normal RWS (either top of active conservation or top of joint use storage, whichever is higher). Once the reservoir is above the maximum normal RWS, seepage flows could increase through flaws or discontinuities in the fill material adjacent to the spillway, in the foundation, or a combination. Seepage velocities could be sufficient to carry soil material, enlarging the discontinuities until a continuous

**Design Standards No. 14: Appurtenant Structures for Dams  
(Spillways and Outlet Works)**

conduit/pipe develops. Internal erosion would continue, eventually leading to a collapse of the conduit/pipe, eroding of the fill material adjacent to the spillway and/or foundation, which would end with uncontrolled release of the reservoir.

- **Chute wall overtopping.** – Flood-induced discharge that exceeds the maximum design discharge, which may result in overtopping of chute walls leading to erosion of adjacent fill material, undermining and failing of a portion of the chute. With extended operation, additional erosion could lead to headcutting and undermining of the control structure and an uncontrolled release of the reservoir. An

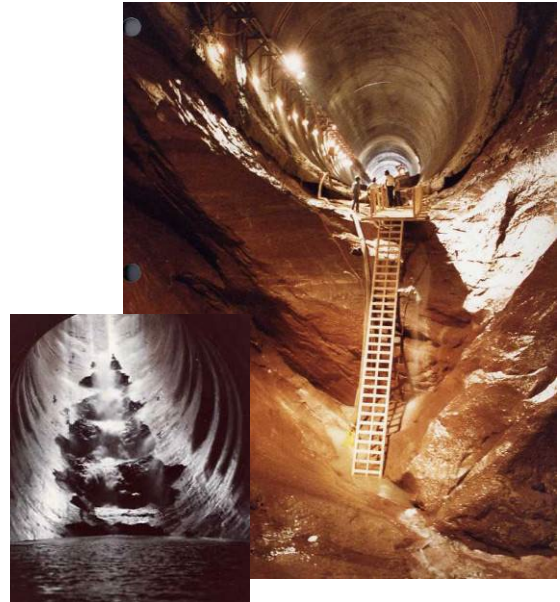


**1999 Dam Failure due to Flood-induced Chute Wall Overtopping – El Guapo Dam, Venezuela (courtesy of Ing. Alejandro Hitcher).**

example was the 1999 flood-induced chute wall overtopping at Venezuela’s El Guapo Dam. This concluded with the full breach of the dam and uncontrolled release of the reservoir.

- **Conduit/tunnel pressurization.** – Flood-induced discharge that exceeds the maximum design discharge which may result in pressurizing a conduit/tunnel that was designed for free-flow conditions. This pressurization could lead to two potential failure paths, one being the conduit/tunnel lining is overloaded and collapses, and the other involves injecting high-pressure flow through conduit/tunnel joints and/or cracks into the surrounding foundation material. With extended operation, erosion adjacent to the conduit/tunnel could lead to de-stabilizing a portion of the conduit/tunnel lining. Once the conduit/tunnel lining has failed, extensive internal erosion (if foundation consists of soil materials) extending to the upstream reservoir, and an uncontrolled release of the reservoir could result.

- **Cavitation of chute and/or conduit/tunnel.** – Discharge through a concrete-lined chute or conduit/tunnel with flow surface offsets at joints and/or other surface irregularities such as cracks may create separation of high velocity flow at the flow surface which results in low pressure zones (vapor bubbles and/or voids form). These bubbles and/or voids rapidly collapse as they move into higher pressure zones, which issue high pressure shock waves. Swarms of collapsing bubbles and/or voids can lead to fatigue and erosion of the flow surface material such as concrete or steel liner. Cavitation damage is cumulative and may not be significant upon first operation, but damage progression increases with operation time. With extended operation, erosion of the concrete and foundation could lead to erosional headcutting upstream to the reservoir and an uncontrolled release of the reservoir. An example was the 1983 flood-induced cavitation of the spillway tunnel at Reclamation’s Glen Canyon Dam. Although there was significant damage there was no breach and uncontrolled release of the reservoir.



**1983 Spillway Tunnel Damage due to Flood-induced Cavitation – Glen Canyon Dam, Arizona-Utah**

- **Stagnation pressure of chute and/or conduit/tunnel.** – Discharge through a concrete-lined chute or conduit/tunnel leads to introduction of high-velocity, high-pressure flow through open flow surface joints or cracks, which can result in structural damage or failure of the concrete lining due to uplift pressures and/or erosion of the foundation. Displacement of portions of the concrete-lined chute or conduit/tunnel can expose the foundation to further erosion. With extended operation, erosion of the foundation could lead to additional erosional headcutting (and undermining of the structure) upstream to the reservoir and an uncontrolled release. Stagnation pressure damage may occur during a single operation,



**1983 Spillway Chute Damage due to Flood-induced Stagnation Pressure – Big Sandy Dam, Wyoming.**



**Design Standards No. 14: Appurtenant Structures for Dams  
(Spillways and Outlet Works)**

or may be cumulative, as is the case with foundation erosion. An example was the 1983 flood-induced stagnation pressure failure of the spillway at Reclamation's Big Sandy Dam. Although the spillway failed, there was no breach and uncontrolled release of the reservoir. Stagnation pressure potential was mitigated by replacing the failed spillway features with features that included defensive design measures such as waterstops across flow surface transverse control joints, transverse foundation keys (cutoffs), longitudinal reinforcement extending across the transverse control joints; anchor bars drilled and grouted into the foundation, filtered underdrains, and insulation to protect the filtered drains from freezing.

- **Sweepout of hydraulic-jump stilling Basin.** – Discharge exceeds original design levels and sweep out the stilling basin occurs (i.e., the hydraulic jump moves out of and downstream of the stilling basin). Erosion and headcutting initiates in the foundation downstream of the stilling basin and progress upstream undermining and causing failure of the stilling basin. If flow durations are long enough erosional headcutting progresses upstream undermining and failing other spillway features such as the conveyance feature and control structure.



**1999 Stilling Basin Sweepout (erosion in downstream channel creating “roster-tail”). Dam Failed due to Flood-induced Chute Wall Overtopping – El Guapo Dam, Venezuela (courtesy of Ing. Alejandro Hitcher).**

Undermining the control structure results in uncontrolled release of part or all of the reservoir.

- **Reinforced concrete structural failure.** – Reinforced concrete features (walls, slabs, conduits, tunnels, etc.) fail as a result of hydrologic loading which exceeds the design loads. Also, if there is concrete deterioration which have weakened and/or damaged the concrete and/or foundation, the reinforced concrete structure could fail due to hydrologic loadings that are less than the original design loadings. The deteriorated concrete could exacerbate other hydrologic potential failure modes such as dam overtopping (due to gate binding), elevated RWS leading to internal erosion (due to frost heave of spillway walls which open up a seepage path between the walls and adjacent fill material), and cavitation and stagnation pressure (due to deteriorated flow surfaces). As previously mentioned, there is no one generic failure or incident event tree associated with reinforced concrete deterioration, rather the effects are



typically reflected in the likelihood of events occurring for other potential failure or incident modes, such as the likelihood (probability) of open joints, offsets, surface irregularities, cracks, and spalls. Types of deterioration mechanisms that have been experienced are further discussed in the “Static (normal operations) PFMs,” specifically “Reinforced concrete structural failure.”

#### Seismic (Earthquake-induced) PFMs

These seismic PFMs are not applicable when the spillway is being operated to pass flood events and/or the RWS exceeds the maximum normal RWS (either top of active conservation or top of joint use, whichever is higher in elevation).

- **Internal erosion.** – Earthquake-induced internal erosion of fill material along the spillway features, in the foundation, or combination, which would result from the RWS at or below the maximum normal RWS (either top of active conservation or top of joint use storage, whichever is higher). As a result of seismic-induced wall deflection or collapse, and separation of the walls from the surrounding fill material or cracking of the foundation, seepage flows could increase through the separation adjacent to the spillway or through foundation cracks or a combination. Seepage velocities could be sufficient to carry soil material; enlarging the discontinuities until a continuous conduit/pipe develops. Internal erosion would continue, eventually leading to a collapse of the conduit/pipe, eroding of the fill material adjacent to the spillway, and/or foundation, which would end with uncontrolled release of the reservoir.
- **Gate failure.** - During an earthquake, one or more of the spillway gates fail and are displaced downstream (in the case of radial or wheel-mounted gates) or lower (in the case of drum and crest gates). If the RWS exceeds the spillway crest, an uncontrolled release of a portion of the reservoir results (it should be noted that the level of release may not exceed safe downstream channel capacity and cause downstream consequences). The seismic loadings could exacerbate existing mechanical and/or structural issues that would not lead to failure under normal loading conditions. Also, the seismic loadings could overstress and fail the spillway gates and/or associated features, such as radial gate trunnions even if there are not existing mechanical and/or structural issues.

**Design Standards No. 14: Appurtenant Structures for Dams  
(Spillways and Outlet Works)**

- **Reinforced concrete structural failure.** –

Reinforced concrete features (walls, piers, slabs, conduits, tunnels, etc.) fail as a result of seismic loading which exceeds the design loads. Also, if there is concrete deterioration which have weakened and/or damaged the concrete and/or foundation, the reinforced concrete structure could fail due to seismic loadings that are less than the original design loadings. The deteriorated concrete could exacerbate other seismic potential failure modes such as gate and pier failure, and internal erosion. As previously mentioned, there is no one generic failure or incident event tree associated with reinforced concrete deterioration, rather the effects are typically reflected in the likelihood of events occurring for other potential failure or incident modes, such as the likelihood (probability) of open joints, offsets, surface tolerance and/or cracks and spalls. Types of deterioration mechanisms that have been experienced are further discussed in the “Static (normal operations) PFMs,” specifically “Reinforced concrete structural failure.”



**1999 Dam and Spillway Failure due to an Earthquake – Shi-Kang Dam, Taiwan.**

# TSC Security Review of Proposed Public Disclosure of Technical Information

**Type:** Design Standard

**Design Standard:** Design Standards No. 14 – Appurtenant Structures for Dams (Spillway and Outlet Works) Design Standards

**Chapters:** 3. General Spillway Design Considerations

**Brief Description of Information:** Technical processes used by the Bureau of Reclamation to evaluate existing spillways, along with selecting, locating and sizing modified and new spillways. A list of key technical references used for each major task involved with evaluate existing spillways, along with selecting, locating and sizing modified and new spillways.

**Requesting/Sponsoring Organization:** Director, Technical Service Center

**Program Office:** Deputy Commissioner, Operations

**Is Information Official Use Only / SENSITIVE?** (Y/N)  N


(to be completed by reviewer)

**Is Information Official Use Only / RESTRICTED?** (Y/N)  N

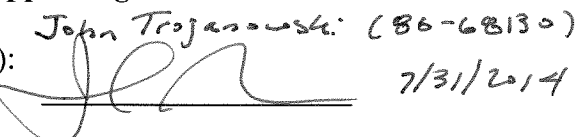
(to be completed by reviewer)

(Sensitive or Restricted information shall not be included in a design standard.)

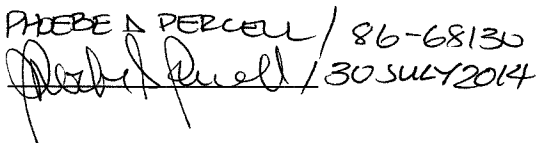
## Design Standard Team Leader:

Name(s)/Mail Code(s): John LaBoon / 86-68130  
Signature(s)/Date(s):  / 7/31/2014

## Group Manager(s) Approving Release:

Name(s)/Mail Code(s): John Trojanowski: (86-68130)  
Signature(s)/Date(s):  / 7/31/2014

## Division Security Reviewer(s) Peer Reviewing Approval:

Name(s)/Mail Code(s): PHOEBE A PERCELL / 86-68130  
Signature(s)/Date(s):  / 30 JULY 2014