



# Technical Manual: Outlet Works Energy Dissipators

Best Practices for Design, Construction, Problem Identification  
and Evaluation, Inspection, Maintenance, Renovation, and Repair

FEMA P-679/ June 2010



FEMA

On the cover.—Vega Dam was completed in 1959 and is located in western Colorado. This embankment dam is 162 feet high. Water for the low level outlet works enters a vertical 5-foot diameter concrete conduit through a trashracked intake structure. The conduit transitions from vertical to horizontal via a circular curve. The conduit continues downstream and transitions to a 3.5-foot square steel conduit within a concrete gate chamber where a 3.5-foot square high pressure emergency gate controls flows within the conduit. The steel conduit transitions to a 51-inch diameter steel pressure pipe within an 8-foot high concrete horseshoe conduit and continues downstream. Near the downstream end, the conduit bifurcates into two 36-inch diameter concrete-encased conduits that enter a regulating structure. Each 36-inch diameter conduit slopes down at about 32 degrees from horizontal, and is controlled by a 2.25-foot square, high pressure regulating gate. Flows from the conduits discharge into an 87.4-foot long stilling basin before entering a canal. The combined discharge capacity of both conduits is approximately 488 ft<sup>3</sup>/s.

**Outlet Works Energy Dissipators**  
**Best Practices for Design, Construction, Problem Identification and**  
**Evaluation, Inspection, Maintenance, Renovation, and Repair**

Federal Emergency Management Agency

**June 2010**

# Preface

Water emerging from an outlet works conduit typically requires dissipation of excess kinetic energy to prevent downstream channel erosion. This flow often discharges at a high velocity and must be directed away from the toe of the dam. An energy dissipator is used to retard the fast moving water by creating turbulence and developing a loss through change in the water's momentum. This prevents damage to the channel downstream from the structure.

The design of an energy dissipating structure can vary from simple to complex. The selection of the proper structure must consider:

- The energy content and unit discharge of the flow entering the dissipator.
- The type of valve or gate used to regulate discharge.
- The number of conduits involved.
- The duration and frequency of flow.
- The compatibility with the conduit or tunnel from which flow is emerging.
- The amount of energy that must be dissipated to control downstream channel erosion.
- Tailwater conditions.
- Alignment and location with respect to the toe of the dam and other features.
- Economic concerns.

Many organizations, such as the Bureau of Reclamation and the U.S. Army Corps of Engineers, have conducted extensive model testing on a variety of energy dissipation structures. In addition, these organizations have made complete evaluations on the performance of full size structures and modified designs to correct design deficiencies when needed. Often, the results of these studies are not well known outside of these organizations. Due to the absence of any single recognized standard for energy dissipators used at dams, there is inconsistency in the design and construction rationale. In an effort to correct this problem, this manual has been prepared to collect and disseminate information and experience that is current and has a technical consensus. The goal of this manual is to provide a nationally recognized source to promote greater consistency between similar project designs,



facilitate more effective and consistent review of proposed designs, and aid in the design of safer, more reliable facilities.

Information on energy dissipators is dispersed in a variety of sources devoted to dams, hydraulics, and open channel flow such as text books, handbooks, and other references. These sources may not reflect advances in research and design, published professional papers, and lessons learned. This manual attempts to condense and summarize the body of existing information, provide a clear and concise synopsis of this information, and present time-tested experience and guidance. The authors reviewed most of the available information on energy dissipators as it relates to use within dams in preparing this manual. Where detailed documentation exists, they cited it to avoid duplicating available materials. The authors have strived not to reproduce information that is readily accessible in the public domain. Where applicable, the reader is directed to selected portions of the [Federal Emergency Management Agency's \(FEMA\) \*Technical Manual: Conduits through Embankment Dams\* \(2005\)](#) and other consensus-accepted references for additional guidance. This manual is intended for use by personnel familiar with dams and outlet works, such as designers, inspectors, construction oversight personnel, and dam safety engineers.

In preparing this manual, the authors frequently found conflicting procedures and standards in the many documents they reviewed. Where conflicts were apparent, the authors focused on what they judged to be the “best practice” and included that judgment in this manual. Therefore, this manual may differ from some of the participating agencies’ own policies.

The authors adopted the same approach toward hazard potential classification as used in [FEMA’s \*Technical Manual: Conduits through Embankment Dams\* \(2005\)](#). The reader is directed to that manual for a complete discussion of hazard potential classification. The hazard potential classification does not reflect in any way on the current condition of the dam (i.e., safety, structural integrity, or flood routing capacity). The three hazard potential classification levels used in this manual, as shown in [table s-1](#) are low, significant, and high as defined in [FEMA 333, \*Federal Guidelines for Dam Safety: Hazard Potential Classification Systems for Dams\* \(1998\)](#):

- *Low hazard potential.*—Dams assigned the low hazard potential classification are those where failure or misoperation results in no probable loss of human life and low economic and/or environmental losses. Losses are principally limited to the owners’ property.
- *Significant hazard potential.*—Dams assigned the significant hazard potential classification are those dams where failure or misoperation results in no probable loss of human life, but can cause economic loss, environmental damage, or disruption of lifeline facilities, or can impact other concerns. Significant hazard potential classification dams are often located in predominantly rural or

agricultural areas, but could be located in areas with significant population and infrastructure.

- *High hazard potential*.—Dams assigned the high hazard potential classification are those where failure or misoperation will probably cause loss of human life.

Table s-1.—Hazard potential classification

Hazard potential classification	Loss of human life	Economic, environmental, lifeline losses
Low	None expected	Low and generally limited to owner
Significant	None expected	Yes
High	Probable—One or more expected	Yes (but not necessary for this classification)

The authors consider the guidance in this manual to be technically valid without regard to the hazard potential classification of a particular dam. However, some design measures that are commonly used for design of high and significant hazard potential dams may be considered overly conservative for use in low hazard potential dams.

Many states, federal agencies, and organizations have developed their own hazard potential classification criteria, which often contain different definitions of low, significant or high ratings. Sometimes, more than three ratings are used.

FEMA, as the lead agency for the National Dam Safety Program, sponsored development of this manual in conjunction with the Association of State Dam Safety Officials, Bureau of Reclamation, Schnabel Engineering Inc., URS Corporation, U.S. Department of Agriculture (Agricultural Research Service and Natural Resources Conservation Service), and U.S. Army Corps of Engineers.

The primary authors of this document were Richard D. Benik, P.E. (Bureau of Reclamation), Chuck Cooper, P.E. (Bureau of Reclamation), Jimmy Crowder, P.E. (Schnabel Engineering, Inc.), Bruce Harrington, P.E. (Maryland Department of the Environment), Mark Haynes, P.E. (Colorado Department of Water Resources), Sherry Hunt, P.E. (U.S. Department of Agriculture—Agricultural Research Service), Anastasia Johnson (Bureau of Reclamation), Robert Kingery, P.E. (Montana Department of Natural Resources and Conservation), Jeffrey McClenathan, P.E. (U.S. Army Corps of Engineers), Dan Pridal, P.E. (U.S. Army Corps of Engineers), David M. Schaaf (U.S. Army Corps of Engineers), Stephen Schlenker, P.E. (U.S. Army Corps of Engineers), Sal Todaro, P.E. (URS Corporation), and Karl Visser, P.E. (U.S. Department of Agriculture—Natural Resources Conservation Service). The technical editor for this manual was Lelon A. Lewis (Bureau of Reclamation). Additional technical assistance was provided by Cynthia Fields

(Bureau of Reclamation), Cindy Gray (Bureau of Reclamation), Gia Price (Bureau of Reclamation), and Kristi Thompson (Bureau of Reclamation).

Peer review of this manual was provided by Laurie Ebner, P.E. (U.S. Army Corps of Engineers), Henry T. Falvey, DWRE (Henry Falvey and Associates, Inc.), Leslie Hanna, F.E. (Bureau of Reclamation), John LaBoon, P.E. (Bureau of Reclamation), Morris Lobrecht, P.E. (U.S. Department of Agriculture–Natural Resources Conservation Service), Fredrick Lux III, P.E. (Schnabel Engineering, Inc.), Danny McCook, P.E. (U.S. Department of Agriculture–Natural Resources Conservation Service), James E. McDonald, P.E. (McDonald Consulting), Paul Perri, P.E. (Colorado Division of Water Resources), Ed Rossilion, P.E. (URS Corporation), Robert Taylor, P.E. (U.S. Army Corps of Engineers), William Wallace, P.E. (U.S. Department of Agriculture–Natural Resources Conservation Service), Charlie Wallis, P.E. (Maryland Department of the Environment), and Sanna Yost, P.E. (Montana Department of Natural Resources and Conservation).

The National Dam Safety Review Board (NDSRB) reviewed this manual prior to issuance. The NDSRB plays an important role in guiding the National Dam Safety Program. The NDSRB has responsibility for monitoring the safety and security of dams in the United States, advising the Director of FEMA on national dam safety policy, consulting with the Director of FEMA for the purpose of establishing and maintaining a coordinated National Dam Safety Program, and monitoring state implementation of the assistance program. The NDSRB consists of representatives appointed from federal agencies, state dam safety departments, and the U.S. Society on Dams. The NDSRB Research Work Group provided additional review. A number of additional engineers and technicians provided input in preparation of this manual, and the authors greatly appreciate their efforts and contributions.

The authors, peer reviewers, and their associated agencies and organizations contributed information and materials for use in this manual. The authors extend their appreciation to the following agencies and individuals for graciously providing additional reviews, information, and permission to use their materials in this publication:

Association of State Dam Safety Officials (ASDSO), Sarah Mayfield  
Louis Bartolini  
Dave Brownell  
Bureau of Reclamation, James Allard, Leo Busch, Elisabeth Cohen, Steve  
Davies, Connie DeMoyer, Brad Dodd, Leon Faris, Kathy Frizell, Warren  
Frizell, Kevin Gagner, Chuck Green, Dennis Hawkins, Mark Healy, Shari  
Hennefer, Walt Heyder, Victoria Hoffman, Doug Hurcomb, Lisa Krest,  
Ken Lally, Bruce Luddington, Mark Healy, Robert McGovern, Don Read,  
Michael Sanchez, Don Stelma, John Strachan, Anthony Vigil, Kurt  
VonFay, Matt Warren, Darrin Williams, and Bob Woodby  
John Cassidy, consulting engineer

Denver Water Department, James Weldon  
Freese and Nichols, Les Boyd  
Glen Hobbs and Associates, Glen Hobbs  
Lee Gerbig, consulting engineer  
Lucky Peak Power Plant Project, Tom Nelson  
Montana Department of Natural Resources and Conservation, Michele  
Lemieux  
John Roberts, consulting engineer  
Rodney Hunt Corporation, Tom McAndrew  
B.T.A. Sagar, consulting engineer  
Schnabel Engineering, Joe Monroe  
Constantine Tjoumas  
U.S. Army Corps of Engineers, Jesse Brown, Joyce Dunning, James Evans,  
Alex McCoy, Roger Kay, and Matthew Watts  
U.S. Department of Agriculture–Natural Resources Conservation Service, Phuc  
Vu  
URS Corporation, Qingwei Fu, Bernard Peter, and Juan Vargas  
Vasconcelles Engineering Corporation, Robert Dalton

Designers must continue to explore and investigate the subject of energy dissipators. No single publication can cover all of the requirements and conditions that can be encountered during design and construction. Therefore, it is critically important that when an energy dissipator is used, the designer must clearly understand all aspects of its design and construction.

The authors caution the users of this manual that sound engineering judgment should always be applied when using references. The authors have strived to avoid referencing any material that is considered outdated for use in modern designs. However, the user should be aware that certain portions of references cited in this manual may have become outdated in regards to design and construction aspects and/or philosophies. While these references still may contain valuable information, users should not automatically assume that the entire reference is suitable for design and construction purposes.

The authors utilized many sources of information in the development of this manual including:

- Published design standards and technical publications of the various federal and state agencies and organizations involved with the preparation of this manual.
- Published professional papers and articles from selected authors, technical journals and publications, and organizations.
- Experience of the individuals, federal and state agencies, and organizations involved in the preparation of this manual.

This manual is available from FEMA in digital versatile disc (DVD) format. The DVD includes built-in Adobe Acrobat Reader software, hyperlinks, and search capabilities. A hyperlink is a highlighted word or image within the manual which, when clicked, takes the user to another place within the manual or to another location altogether. Hyperlinks are especially useful when the user wants to see the full reprint of a cited reference or the exact location in a reference from which the material was cited. The DVD contains the manual, portable document format (PDF) copies of the cited references that were available in the public domain or where permission for reprint was granted, plus “additional reading” references in PDF format. The “additional reading” references are references that have not been specifically cited in the manual but may be of additional interest to the user.

This manual can also be downloaded from the FEMA website at:

<http://www.fema.gov/plan/prevent/damfailure/publications.shtm>

This manual is intended solely for noncommercial and educational purposes. PDF copies of references available in the public domain have been included on the DVD whenever possible. For references not readily available in the public domain, the authors tried to obtain copyright permission. Users should be aware that PDF copies for a number of cited references were unavailable due to size constraints, lack of availability in the public domain, or permission for reprint not being granted. These references have been hyperlinked to a PDF file titled “Document unavailable.” For these references, users may want to contact the author or publisher directly for reprint information.

Suggestions for changes, corrections, or updates to this manual should be directed to:

Bureau of Reclamation  
Denver Federal Center, Bldg. 67  
6th Avenue and Kipling Street  
Denver CO 80225-0007  
Attention: Chuck Cooper (86-68130)

Please reference specific pages, paragraphs, or figures within the manual, together with proposed new material in any convenient format. Sources of proposed new material should be completely cited. Submission of material signifies permission for use in a future revised edition of this manual, but credit for such new material will be given where appropriate.

The material presented in this manual has been prepared in accordance with recognized engineering practices. The guidance in this manual should not be used without first securing competent advice with respect to its suitability for any given application. The publication of the material contained herein is not intended as

representation or warranty on the part of individuals or agencies involved, or any other person named herein, that this information is suitable for any general or particular use, or promises freedom from infringement of any patent or patents.

Anyone making use of this information assumes all liability from such use. Any use of trade names and trademarks in this manual is for descriptive purposes only and does not constitute endorsement. The information contained herein regarding commercial products or firms may not be used for advertising or promotional purposes and is not to be construed as an endorsement of any product or firm.





# Contents

	<i>page</i>
Preface.....	iii
Common Abbreviations.....	xxxix
Conversion Factors.....	xxxiv
Symbols.....	xxxv
AASHTO Standards.....	xxxvix
ASTM Standards.....	xl
Websites.....	xli
Introduction.....	1
Chapter 1—General.....	7
1.1 Additional Design Considerations.....	16
1.2 Risk and Downstream Consequences.....	19
Chapter 2—Hydraulic Jump Stilling Basins.....	23
2.1 Hydraulic Jump.....	23
2.2 The Froude Number and the Hydraulic Jump.....	24
2.3 Initial Depth, Sequent Depth, Conjugate Depth, and Tailwater Depth.....	28
2.4 Length of the Hydraulic Jump Stilling Basin.....	31
2.5 Stilling Basin Appurtenances.....	32
2.5.1 Chute blocks.....	33
2.5.2 Baffle blocks.....	34
2.5.3 End sill.....	35
2.6 Other Stilling Basin Features.....	35
2.6.1 Side walls and training walls.....	36
2.6.2 Splitter walls.....	37
2.6.3 Wing walls.....	38
2.6.4 Cutoff walls.....	38
2.6.5 Stoplog slots.....	39
2.6.6 Structure underdrains.....	39
2.6.7 Flow deflectors.....	44
2.7 Selection of a Hydraulic Jump Stilling Basin.....	46
2.7.1 Reclamation stilling basins.....	49
2.7.1.1 Type I basin.....	49
2.7.1.2 Type II basin.....	49
2.7.1.3 Type III basin.....	50
2.7.1.4 Type IV basin.....	53
2.7.1.5 Type V basin.....	54
2.7.1.6 Type VIII basin.....	61
2.7.2 USACE stilling basin.....	64
2.7.3 SAF stilling basin.....	65

## Outlet Works Energy Dissipators

---

Chapter 3—Impact Basins.....	69
3.1 Type VI Impact Basins.....	69
3.2 Streambed-Level Basins.....	77
3.2.1 Hook basin.....	77
3.2.2 Standard baffle basin.....	78
3.2.3 Colorado State University rigid boundary basin.....	79
Chapter 4—Plunge Basins.....	81
4.1 Types of Plunge Basins.....	82
4.2 Jet Trajectory.....	83
4.3 Plunge Basin Scour Process.....	84
4.4 Plunge Basin Design.....	85
4.5 Flip Bucket.....	88
Chapter 5—Stilling Wells.....	91
5.1 High Head Application.....	91
5.1.1 Design considerations.....	93
5.1.2 Design guidance.....	93
5.1.3 Other considerations.....	94
5.2 Low Head Application.....	95
5.2.1 Design considerations.....	95
5.2.2 Design guidance.....	98
5.2.3 Other considerations.....	100
Chapter 6—Conduit Outlet Expansions (Flow Transitions).....	101
6.1 Expansion to a Channel.....	101
6.2 Expansion with a Hydraulic Jump.....	101
6.3 Expansion to a Stilling Basin.....	104
6.4 Design Guidance.....	104
6.5 Design Considerations.....	106
Chapter 7—Valve and Gate Selection and Energy Dissipation Requirements.....	109
7.1 Fixed-Cone Valves.....	109
7.1.1 Performance.....	110
7.1.2 History.....	112
7.1.3 Fixed-cone valve discharging into horizontal energy dissipation chambers.....	114
7.1.4 Hooded fixed-cone valve.....	116
7.2 Sleeve Valves.....	120
7.2.1 Performance.....	121
7.2.2 History.....	122
7.2.3 Multi-ported sleeve valves.....	122
7.2.3.1 Horizontal energy dissipators for multi-ported sleeve valves.....	124
7.2.3.2 Vertical stilling well energy dissipators for multi-ported sleeve valves.....	125

7.2.3.3 Vertical stilling well energy dissipator for bottom discharge sleeve valves.....	127
7.3 Multiple Orifice Valve.....	128
7.3.1 Performance.....	130
7.3.2 History.....	130
7.4 Butterfly Valve.....	132
7.4.1 Performance.....	132
7.4.2 History.....	132
7.4.3 Butterfly valves for regulating free discharge flow.....	132
7.4.4 Butterfly valves for guard valve.....	134
7.5 Jet-Flow Gate.....	134
7.5.1 Performance.....	134
7.5.2 History.....	137
7.6 Bonneted Slide Gate and High Pressure Slide Gate.....	138
7.6.1 Performance.....	138
7.6.2 History.....	139
7.7 Cast-Iron Slide Gate (Unbonneted).....	141
7.7.1 Performance.....	143
7.7.2 History.....	143
7.8 Fabricated Slide Gate.....	145
7.8.1 Performance.....	145
7.8.2 History.....	146
7.9 Clamshell Gate.....	147
7.9.1 Performance.....	148
7.9.2 History.....	150
7.10 Top-Seal Radial Gate.....	151
7.10.1 Performance.....	151
7.10.2 History.....	153
7.11 Fixed-Wheel Gate.....	154
7.11.1 Performance.....	154
7.11.2 History.....	154
Chapter 8—Sudden Enlargements and Inline Orifices.....	157
8.1 General.....	157
8.2 Basic Considerations.....	159
8.2.1 Head loss, pressure, and velocity considerations.....	161
8.2.1.1 Dimension and velocity of jet entering sudden enlargement.....	161
8.2.1.2 Sudden enlargements without jet contraction.....	162
8.2.1.3 Sudden enlargements with jet contraction (inline orifices).....	163
8.2.2 Type of enlargements and orifices and effects on energy dissipation.....	167
8.2.3 Cavitation and its prevention.....	170
8.3 Design Criteria and Guidance.....	173
8.3.1 Cavitation.....	173
8.3.1.1 The Tullis method of cavitation analysis.....	173
8.3.1.2 Alternative methods of cavitation analyses.....	175

8.3.2 Distance between series of inline orifices.....	177
8.3.3 Energy loss computations for sudden expansion and inline orifices .....	177
8.3.4 Considerations for downstream orifices or sudden enlargements.....	178
8.4 Design Guidance for Sudden Enlargements and Inline Orifices.....	178
Chapter 9—Riprap and Concrete Blocks .....	183
9.1 Riprap.....	183
9.1.1 Riprap aprons .....	183
9.1.1.1 New York and Maryland design guidance .....	184
9.1.1.2 HEC-14 design guidance.....	184
9.1.1.3 Boulder County storm drainage design guidance .....	187
9.1.2 Riprap basins.....	187
9.2 Transitional Riprap Aprons Downstream of Energy Dissipators.....	189
9.2.1 Application.....	190
9.2.2 Transitional riprap design below SAF stilling basins.....	190
9.2.3 Hydraulic Properties .....	191
9.2.4 Hydraulic design rock chart.....	191
9.3 Riprap.....	192
9.3.1 Gradation .....	192
9.3.2 Shape.....	193
9.3.3 Durability.....	193
9.3.4 Placement.....	194
9.3.5 Filter bedding.....	195
9.3.5.1 Granular bedding.....	195
9.3.5.2 Geotextiles .....	196
9.4 Grouted riprap.....	197
9.5 Wire-enclosed rock or gabions.....	199
9.6 Articulated Concrete Blocks .....	199
9.6.1 Materials .....	201
9.6.1.1 Blocks.....	201
9.6.1.2 Connections.....	201
9.6.1.3 Geotextile.....	203
9.6.1.4 Filter.....	203
9.6.2 Performance testing and evaluation .....	205
9.6.3 Design guidance .....	205
9.6.4 Specifying ACB systems.....	206
9.6.4.1 Materials.....	206
9.6.4.2 Testing.....	207
9.6.4.3 Design .....	207
9.6.5 Installation.....	208
9.6.5.1 Subgrade preparation .....	208
9.6.5.2 Geotextile placement .....	208
9.6.5.3 Placement of the ACB .....	208
9.6.5.4 Termination.....	210

9.6.5.5 Anchor .....	210
9.6.5.6 Filling.....	210
Chapter 10—Baffled Drops .....	211
10.1 Design Considerations.....	211
10.2 Design Guidance .....	216
10.3 Baffled Drops for Conduit Outlets .....	220
Chapter 11—Inspection.....	221
11.1 Types of Inspections.....	222
11.2 Factors Influencing Scheduling of Inspections.....	224
11.3 Periodic Inspections by Selected Organizations .....	226
11.4 Preparing for an Inspection .....	226
11.5 Performing the Inspection .....	230
11.6 Specialized Inspection.....	239
11.6.1 Dive team .....	239
11.6.2 Climbing team .....	244
11.6.3 Remotely operated vehicle.....	245
11.6.4 Closed circuit television (CCTV).....	248
11.6.5 Soundings .....	251
11.6.6 Sonar.....	251
11.6.7 Unwatering a dissipation structure for inspection .....	254
11.6.8 Cleaning of dissipation structures.....	256
11.6.8.1 Cleaning methods .....	256
Chapter 12—Maintenance and Repair.....	261
12.1 Diagnosis of cause.....	262
12.1.1 Evaluation of the structure.....	263
12.1.1.1 Review of engineering data .....	263
12.1.1.2 Condition survey .....	263
12.1.1.3 Underwater inspection.....	267
12.1.1.4 Laboratory investigations .....	267
12.1.1.5 Nondestructive testing.....	267
12.1.1.6 Additional investigations .....	267
12.1.2 Causes of distress and deterioration.....	267
12.1.2.1 Accidental loadings .....	269
12.1.2.2 Chemical reactions .....	269
12.1.2.3 Construction errors .....	271
12.1.2.4 Corrosion of embedded materials.....	271
12.1.2.5 Design errors.....	272
12.1.2.6 Erosion.....	272
12.1.2.7 Freezing and thawing.....	274
12.1.2.8 Settlement and movement .....	275
12.1.2.9 Shrinkage .....	275
12.1.2.10 Temperature changes.....	275



## Outlet Works Energy Dissipators

---

12.1.2.11 Weathering .....	275
12.1.3 Relating symptoms to causes of distress/deterioration.....	275
12.2 Methods of Repair.....	277
12.2.1 Design of concrete repairs.....	277
12.2.1.1 Properties of repair materials.....	277
12.2.1.2 Application and service conditions.....	279
12.2.1.3 Material selection.....	280
12.2.1.4 Repairs material database .....	280
12.2.1.5 General categorization of repair approach .....	281
12.2.2 Concrete removal and preparation for repair .....	281
12.2.3 Materials and methods .....	281
12.2.4 Underwater repairs .....	281
12.3 Maintenance of Concrete .....	281
12.3.1 Surface coatings and sealing compounds .....	282
12.3.2 Joint maintenance .....	282
Chapter 13—Public Safety and Vandalism Protection.....	283
13.1 Discouraging Access .....	283
13.1.1 Signs and buoys.....	284
13.1.2 Audible devices .....	286
13.1.3 Lights .....	286
13.1.4 Camouflage .....	287
13.2 Preventing Access .....	287
13.2.1 Land-based access barriers .....	287
13.2.2 Boat barriers.....	287
13.2.3 Vegetation .....	288
13.2.4 Marshes.....	289
13.2.5 Guards .....	289
13.3 Extraction and Self-Rescue.....	289
13.3.1 Slope changes .....	289
13.3.2 Benches .....	289
13.3.3 Handholds and ladders.....	289
13.3.4 Cables and nets.....	290
13.3.5 Life preservers .....	290
13.4 Vandalism Protection .....	290
13.4.1 Consequences of rock throwing.....	290
13.4.2 Preventive measures .....	292
References .....	295
Additional Reading.....	305
Index .....	305
Glossary .....	341

**Appendix—Case Histories**

<i>Name</i>	<i>page A-</i>
Agate Dam, Oregon: Difficulties experienced with a sleeve valve and vertical stilling well .....	1
Arkabutla Dam, Mississippi: Abrasion erosion damage to a stilling basin .....	7
Clark Canyon Dam, Montana: Underwater dive inspection of a type II stilling basin .....	12
Enid Dam, Mississippi: Abrasion erosion damage to stilling basin.....	17
Elkhhead Creek Dam, Colorado: Fixed-cone valve and concrete lined plunge pool.....	23
Ganado Dam, Arizona: Design and construction of a type VI stilling basin.....	30
Guadalupe Flood Control Project, California: Displacement of articulated concrete blocks .....	35
Kinzua Dam, Pennsylvania: Stilling basin experiences abrasion erosion damage and the subsequent repairs.....	41
Lucky Peak Dam, Idaho: Problems with flip bucket operation.....	53
Mason Dam, Oregon: Stilling basin flow deflector.....	58
Mica Dam, Canada: Sudden enlargement.....	68
Navajo Dam, New Mexico: Abrasion erosion damage at a hollow-jet stilling basin .....	70
Nilan North Dam, Montana: Replacement of a flared transition type energy dissipator.....	76
Norman Dam, Oklahoma: Slope slumping develops after unwatering of a stilling basin .....	80
Palisades Dam, Idaho: Abrasion erosion damage to a stilling basin .....	87
Palm Tree Creek Outlet, Australia: Performance of high head vertical stilling well using a ported sleeve valve.....	93
Pineview Dam, Utah: Inline orifices in a steel bypass pipe .....	96
Pomme de Terre Dam, Missouri: Abrasion erosion in a stilling basin .....	98
Pomona Dam, Kansas: Abrasion erosion damage in a stilling basin .....	103
Seven Oaks Dam, California: Design of a plunge basin .....	108
Seven Oaks Dam, California: Inline orifices .....	113
Standley Lake Dam, Colorado: Design and construction of a lined plunge basin .....	124
Twin Lakes Dam, Colorado: CCTV Inspection of a stilling basin underdrain system.....	132
Virginia Smith Dam, Nebraska: Dive inspection reveals stilling basin damage and requires repairs to be performed .....	145
Virginia Smith Dam, Nebraska: Detection of internal erosion beneath a stilling basin and the subsequent repairs .....	153
Xiaolangdi Dam, China: Inline orifices.....	162

## Tables

<i>No.</i>	<i>page</i>
1	Important design considerations for selected energy dissipators..... 18
2	Hydraulic jump classified by Froude number..... 25
3	Example flow/discharge ratio summary..... 97
4	Conduit outlet expansions ..... 106
5	Example riprap apron dimensions..... 185
6	Terms associated with visual inspection of concrete..... 265
7	Common causes of distress and deterioration in concrete ..... 268
8	Relating symptoms to causes of distress and deterioration of concrete ..... 276

## Figures

<i>No.</i>	<i>page</i>
1	Alternative arrangements for guard and regulating valves and gates for embankment dams ..... 2
2	A hydraulic jump occurring in an outlet works energy dissipator ..... 3
3	An outlet works discharging into a spillway stilling basin..... 4
4	If the downstream formation consists of competent rock where the potential for erosion is negligible, an energy dissipator may not be required..... 5
5	Hydraulic jump stilling basin. Note the hydraulic jump flow pattern on the interior surface of the basin walls ..... 10
6	A stationary baffle in an impact basin..... 11
7	A riprap-lined plunge basin downstream from a cantilevered pipe..... 11
8	Flow being discharged from a flip bucket into an unlined plunge basin ..... 12
9	This 48-inch diameter perforated steel discharge pipe is located downstream of the sleeve valve in a stilling well. The 72 6-inch diameter openings are provided to more evenly distribute the flow from the sleeve valve into the well. The stilling well dissipates any remaining head after the sleeve valve and releases water into the downstream chute without any spray that may cause icing..... 12
10	Conduit outlet expansion ..... 13
11	Flow emerging from a Howell-Bunger valve ..... 14
12	Clamshell gate ..... 14
13	Orifice pit and assembly with adjustable coupler, orifice plate, and downstream air release valve ..... 15
14	Cable-tied concrete blocks..... 16
15	A baffled drop used for energy dissipation at a grade change..... 17

16	Hydraulic jump formations on a horizontal surface .....	26
17	The Froude number for the discharge in this model study is greater than 10.0. Note the rough water surface with strong waves downstream from the jump .....	27
18	Relationship between variables in a hydraulic jump. ....	29
19	Minimum tailwater depths. ....	30
20	Length of hydraulic jump for type I, II, and III basins. ....	32
21	Looking upstream at a chute block located at the upstream entrance of a stilling basin. A structural underdrain exits from the downstream face of the chute block .....	33
22	Baffle blocks in a hydraulic jump stilling basin (flow is from left to right) .....	34
23	A dentated end sill for a combined outlet works and spillway stilling basin.....	35
24	Type II stilling basin with counterforted walls. The basin has been unwatered for repairs.....	37
25	Splitter wall separating discharge from two conduits .....	38
26	Wingwalls oriented normal to the basin side walls.....	39
27	Stoplogs have been installed in slots to allow for repairs to be made to the unwatered stilling basin .....	40
28	Filtered underdrain to prevent movement of foundation materials into drainage system and the initiation of foundation erosion.....	41
29	Alternative underdrain system—(a) lateral (horizontal) collector drain with drilled/formed (vertical) weep hole drains. Note lateral collector drain is embedded in concrete to minimize disturbance to foundation. Cleanouts and covers for vertical drilled/formed drains are not shown, but are required for maintenance and inspection. (b) Typical detail of vertical drilled drain hole....	44
30	Desired flow pattern avoids recirculating currents .....	45
31	Flow deflectors being installed at the downstream end of a stilling basin.....	47
32	Type II basin characteristics for Froude numbers greater than 4.5 and incoming velocities greater than 60 ft/s. ....	51
33	Type III basin characteristics for Froude numbers above 4.5 and incoming velocities less than 60 ft/s.....	52
34	This wave suppressor (also known as an underpass-type) was constructed after completion of the stilling basin to prevent unanticipated waves exiting the basin from overtopping the downstream canal lining. Overtopping could result in either undermining of the soil supporting the canal lining or introduction of uplift pressures beneath the canal lining. Note the formed openings through the deck of the wave suppressor.....	53
35	Type IV basin characteristics for Froude numbers between 2.5 and 4.5.....	55
36	Alternative low Froude number basin characteristics.....	56
37	Hydraulic jump on a slope. ....	57
38	Ratio of tailwater to initial depth for jump on slope (type V basin, case D).....	58
39	Ratio of length of jump to tailwater on slope (type V basin, case D). ....	59
40	Ratio of tailwater to conjugate depth (type V basin, case B).....	60

41	This figure shows a hydraulic jump occurring in a 1:48-scale model of a type V stilling basin for a spillway. The operating condition equates to a prototype discharge of 60,000 ft <sup>3</sup> /s. The 242-foot wide stilling basin has an 0.8:1 slope for the upstream 178.7-foot length and is horizontal for the downstream 146.8-foot length. The stilling basin has a 15-foot high solid end sill. The figure most closely depicts the condition discussed in case C where the upstream toe of the hydraulic jump occurs on the slope and the downstream end of the jump is at the junction of the slope and the horizontal apron (for this example, where the break in floor slope goes from 0.8:1 to horizontal) .....	61
42	Two 72-inch diameter hollow-jet valves and stilling basin .....	62
43	Hollow-jet valve stilling basin generalized design. ....	63
44	USACE stilling basin layout. ....	65
45	Channel profile to prevent flow eddies leaving the USACE stilling basin from pulling downstream riprap into the stilling basin. ....	66
46	SAF stilling basin.....	67
47	Proportions and definitions of the SAF stilling basin. The dimensions are based on the kinetic flow factor.....	68
48	Type VI impact basin with no flow being discharged .....	70
49	Type VI impact basin with flow being discharged .....	70
50	Dimensional criteria for a type VI stilling basin. ....	71
51	Type VI impact basins placed side by side.....	72
52	Reclamation design aid for type VI impact basins .....	75
53	Federal Highway Administration design curve for type VI impact basins. ....	75
54	The end of this outlet conduit was constructed too close to the vertical hanging baffle resulting in intense sprayback.....	76
55	Hook basin.....	78
56	A standard baffle basin.....	79
57	Basin utilizing staggered rows of baffles.....	80
58	Unlined plunge basin (view is looking downstream). This basin has been allowed to scour over time.....	82
59	A riprap-lined plunge basin .....	83
60	Concrete-lined plunge basin with baffle wall, grouted riprap side slopes, and discharge channel. Flow discharges into the plunge basin from two 36-inch diameter fixed-cone valves.....	83
61	Jet trajectory from a 54-inch diameter hooded fixed-cone valve.....	84
62	Typical lined plunge basin design. ....	88
63	Typical Reclamation stilling well application. The corner fillets and pedestal in the invert tend to maximize the circulation and energy dissipation in the lower portion of the well.....	92
64	This stilling well was installed in 1966 and consists of a 10-foot wide well, 16-foot depth, and a 24-inch diameter sleeve valve. Design discharge is 78 ft <sup>3</sup> /s at a static head of 88 feet.....	94
65	Stilling well a at conduit outlet .....	96
66	Typical stilling well at a conduit outlet.....	96

67	Determination of storm drain conduit stilling well diameter. ....	98
68	Depth of USACE stilling well below conduit invert. ....	99
69	This outlet works conduit is a 54-inch diameter horseshoe shape, with a normal operating head of 66 feet. Note that the hydraulic jump occurs downstream from the transition structure.....	102
70	Half isometric drawing of one half of a USDA-NRCS type PWD basin.....	103
71	7.5-foot horseshoe conduit discharging into an outlet expansion with a depressed floor. Downstream channel armoring has also been provided.....	103
72	A flared outlet transition .....	105
73	Fixed-cone valve.....	110
74	Fixed-cone valve discharging at a small opening.....	111
75	Fixed-cone valve discharging at a large opening .....	111
76	Ice build-up under 48-inch diameter hooded fixed-cone valves. Ice has built to the elevation of the bottom of the valve operating deck, approximately 60 feet above streambed. Photo courtesy of Denver Water .....	113
77	Typical section through fixed-cone valve horizontal energy dissipator. Figure courtesy of URS Corporation .....	115
78	Discharge from a 96-inch diameter hollow-jet valve on the left (looking upstream) and a 108-inch diameter fixed-cone valve on the right. The discharge from the fixed-cone valve is very calm after passing through the two stage chamber, the spray seen is inside the 2nd stage of the chamber. However, a wave suppresser is required as seen at the bottom left of the figure .....	115
79	Manufacturer’s standard valve and hood dimensions for fixed-cone valves. Figure courtesy of Rodney Hunt Corporation .....	117
80	Hooded fixed-cone valve. Photo courtesy of URS Corporation and Denver Water Board.....	118
81	48-inch diameter hooded fixed-cone valve discharge. Photo courtesy of URS Corporation and Denver Water Board.....	118
82	48-inch diameter hooded fixed-cone valve discharge. Photo courtesy of URS Corporation and Denver Water.....	119
83	A 48-inch diameter hooded fixed-cone valve. Note erosion of riprap in downstream channel. Photo courtesy of URS Corporation and Denver Water Board.....	119
84	Erosion of riprap downstream form a 48-inch diameter hooded fixed-cone valve. Photo courtesy of URS Corporation and Denver Water Board.....	120
85	A bottom discharge sleeve valve being fabricated .....	121
86	Basket strainer for a multi-ported sleeve valves. Photo courtesy URS Corporation.....	123
87	Model 814 Polyjet Sleeve Valve. Manufacturer’s standard dimensions for a horizontal sleeve valve discharging to free air. Drawing courtesy of Bailey Valve, Inc.....	124
88	The 48-inch diameter sleeve valve is located within a valve house and discharges directly into a horizontal stilling well. Photo courtesy of URS Corporation.....	125



## Outlet Works Energy Dissipators

---

89	Model 811 Polyjet Sleeve Valve. Typical vertical stilling well layout dimensions for vertical stilling well. Drawing courtesy of Bailey Valve, Inc ..	126
90	Submerged discharge valve well for a manually activated 44-inch diameter valve .....	127
91	Bottom discharge of a submerged discharge valve. Note the V port openings.....	128
92	Fabrication of a Monovar valve. Photo courtesy of Sapag.....	129
93	Schematic diagram of a Monovar valve. Figure courtesy of Sapag .....	129
94	Monovar valve used as a free discharge valve. Photo courtesy of Sapag .....	131
95	Large diameter butterfly valve. Photo courtesy of Rodney Hunt Corporation.....	133
96	Jet-flow gate .....	135
97	Jet-flow gate in operation. Photo courtesy of URS Corporation.....	135
98	Jet-flow gate at partial opening. Photo courtesy of URS Corporation .....	136
99	Jet-flow gate at full opening. Photo courtesy of URS Corporation.....	136
100	68- and 90-inch diameter jet-flow gates discharging. Photo courtesy of URS Corporation .....	138
101	One half of a tandem bonneted gate system.....	139
102	A fabricated (stainless steel) bonneted gate being produced for 200 feet of head. Photo courtesy of Rodney Hunt Corporation .....	141
103	Stilling basin for an outlet and spillway in a concrete dam .....	142
104	Unbonneted slide gate .....	142
105	Shop testing of cast-iron slide gate. Photo courtesy of Rodney Hunt Corporation.....	144
106	Installation of large fabricated slide gates. Photo courtesy of Rodney Hunt Corporation.....	145
107	Light-duty fabricated slide gate. Figure courtesy of Rodney Hunt Corporation.....	146
108	48-inch diameter clamshell gate before installation .....	147
109	68-inch diameter clamshell gate at 100-percent open.....	148
110	Ten clamshell gates operating fully open.....	149
111	Clamshell gates operating under 50 feet of submergence. No air was entrained during submerged discharge .....	149
112	78-inch diameter clamshell gate used for evacuation of a siphon.....	150
113	Installation of 21-foot wide by 30-foot high top-seal radial gates (design head 132 feet). Gates are located at the upstream end of waterways. (a) Upward view of hoist support beam assembly. (b) Downstream view of radial gate leaf and arm assembly. Gate trunnions (not shown) are mounted on downstream headwalls .....	152
114	Fixed-wheel gate measuring 16 feet wide by 26 feet high. Photo courtesy of Rodney Hunt Corporation.....	155
115	Total energy (EGL) and hydraulic (HGL) gradelines in an inline orifice system.....	158
116	Looking upstream at inline orifices within a 36-inch outside diameter pipe....	160

117	Typical flow patterns and hydraulic variables in sudden expansion or inline orifice .....	160
118	Types of jets entering expansion areas in sudden enlargements: (a) no jet contraction; (b) with jet contraction.....	162
119	Design schematic of Mica Dam.....	168
120	Design concept of Xiaolangdi Hydraulic Project on the Yellow River, China .....	170
121	Alternative orifice configurations .....	171
122	A riprap apron used for erosion protection.....	184
123	Half plan of riprap basin.....	188
124	Profile of a riprap basin.....	188
125	Transitional riprap apron downstream for a type VI stilling basin to prevent scour .....	190
126	The grouted riprap has performed well although some of the larger rocks in the foreground are displaced immediately downstream of the concrete apron .....	198
127	Gabion-lined basin. The earthen basin was used to facilitate construction access and has been removed.....	200
128	Modified type PWD basin used with 48-inch diameter conduit with 45 feet of head. The discharge is operationally limited to 150 ft <sup>3</sup> /s.....	200
129	Examples of ACB revetment systems Courtesy of HCFCD (2001).....	202
130	Steel cables .....	202
131	Polyester cables.....	203
132	ACB Section with a geotextile filter and combination geotextile and granular filter. Figure provided courtesy of HCFCD (2001).....	204
133	An ACB system using a combination granular and geotextile filter.....	204
134	Insufficient anchorage resulted in uplift of these ACB blocks during flow.....	206
135	Granular filter encapsulation by a geotextile. Figure provided courtesy of HCFCD (2001).....	209
136	Typical baffled drop at a change in grade.....	212
137	Flow depth and acceptable approach velocities. ....	213
138	Baffled chute with approach depression to lower approach velocities.....	214
139	This baffled drop has a chute that is 9 feet wide and 90 feet in length founded upon a 2:1 slope. The training walls are 5 feet high. The baffles are 18 inches high and wide with 18-inch spaces between them. The rows of baffles are all 6 feet apart .....	215
140	Baffled drop aerating the flow so that it becomes saturated .....	216
141	Fujimoto entrance for baffled drops.....	218
142	Typical baffled drop layout.....	219
143	Typical plan for baffled drop downstream from box culverts .....	220
144	A periodic inspection being performed at an impact basin .....	223
145	The invert of this flip bucket sustained significant cavitation damage during operation.....	232
146	A dive team inspection revealed significant concrete damage and exposed reinforcement on this stilling basin floor caused by abrasion erosion .....	233

## Outlet Works Energy Dissipators

---

147	Abrasion erosion damage at a dentate block.....	234
148	Eroded concrete caused by abrasion.....	234
149	Vertical crack in wall.....	235
150	Loss of joint filler in a wall joint.....	235
151	The protective concrete cover has been removed exposing the reinforcement.....	236
152	This vertical wall joint has experienced a 2-inch offset.....	237
153	Debris deposited around a chute block.....	238
154	A sinkhole developed next to this basin wall indicating internal erosion of foundation materials was occurring.....	239
155	A diver preparing to perform a stilling basin inspection.....	240
156	A diver inspecting a baffle block.....	241
157	A diver inspecting the chamfer on chute block.....	241
158	A climbing team preparing to perform a wall inspection.....	245
159	An observation-class ROV entering the water to begin an inspection.....	248
160	A camera-crawler used for CCTV inspection.....	249
161	Small video camera that can be attached to PVC or metal poles and manually pushed into underdrain pipes.....	251
162	Interior of a USACE boat equipped for surface deployment of an acoustical imaging system.....	253
163	Acoustical imaging camera mounted with pan and tilt mechanism.....	254
164	Inspection of stilling basin for abrasion erosion using an acoustical camera. Rock can be seen lying on the stilling basin floor.....	255
165	Divers assisting with the installation of stoplogs at the downstream end of a stilling basin. Turnbuckles were attached to the stoplogs and basin. These held the stoplogs against the end of the basin walls until the basin was unwatered and the outside water pressure kept them in place. Rubber seals on the stoplogs prevented leakage.....	257
166	Cofferdam constructed to keep the basin area dry for repairs.....	257
167	A polyethylene baffled bladder dam is being placed downstream from a stilling basin. The dam is 250 feet long by 19 feet wide by 8 feet high. The dam weighs 2,600 pounds (dry). Two 3-inch pumps (8 hp) and two 3-inch pumps (4.5 hp) were used to fill the dam with 150,000 gallons of water. The dam took about four hours to deploy (watering up and rolling out the dam). Upon removal, the dam took 2 hours of dewatering and 2½ hours to roll up and remove. Removal of the dam required the rental and use of two track-hoes for rolling up the dam on a log.....	258
168	Recirculating flow pattern pulling rocks into the basin.....	259
169	This baffle block has experienced impact damage resulting from an object in the flow.....	270
170	Chemical attack is often characterized by surface disintegration and spalling.....	271
171	Sawcutting the perimeter of spalled concrete prior to removal of concrete....	278
172	Blowing compressed air over the surface of the concrete to remove excess moisture.....	278

173	Person taking great risk near an intake structure.....	284
174	Warning sign .....	285
175	Fencing installed along the tops of the stilling basin walls .....	288
176	Fencing at a stilling basin. The steep cliffs also provide an access deterrent.....	288
177	Minor abrasion erosion damage.....	291
178	Severe abrasion erosion damage .....	291
179	Small aggregates can cause damage .....	292
180	Inclined fencing to reduce damage from vandalism .....	293

## Tables in the Appendix

<i>No. A-</i>		<i>page A-</i>
1	Filler concrete proportioned with ¾-inch maximum size aggregate.....	10
2	Estimated and recommended reservoir evacuation times for Nilan North Dam at a maximum release rate of 150 ft <sup>3</sup> /s .....	78
3	Developed mix design for repair of stilling basin.....	90
4	Fresh concrete properties .....	90
5	Concrete materials and mixture proportions .....	104
6	Average test results .....	104
7	Field observations during 2005 flow tests at Seven Oaks Minimum Discharge Line.....	117
8	Seven Oaks MDLE inline orifice dimensions, average pressure heads with respect to pipe springline (gauge) ( $H_p = -31.3$ ft), and average orifice velocities depending on range of estimated discharge rates .....	119
9	Estimated range of probable discharge rates based on matching sums of computed head losses from different references with sums of prototype orifice head losses.....	119
10	Comparison of Tullis indices with respect to Seven Oaks Dam data .....	121

## Figures in the Appendix

<i>No. A-</i>		<i>page A-</i>
A-1	Combined spillway and outlet works basin. The sleeve valve is located in the control house on the right side of the basin.....	2
A-2	Control stand.....	3
A-3	Handwheel control for sleeve valve. The handwheel requires 36¾ turns to fully open the valve from the closed position.....	4

## Outlet Works Energy Dissipators

---

A-4	Truncated distributor cone.....	5
A-5	Outlet works discharge enters the spillway stilling basin through an opening in the right wall .....	5
A-6	Aerial view of the upstream face of Arkabutla Dam .....	7
A-7	Abrasion erosion and repair of the baffle .....	8
A-8	Exposed reinforcement in the stilling basin downstream of the baffles .....	10
A-9	View looking downstream from top of dam with outlet works stilling basin in middle and spillway stilling basin to the left.....	12
A-10	View looking upstream at the outlet works stilling basin. During the inspection of the basin, approximately 25 ft <sup>3</sup> /s was flowing through the outlet works .....	13
A-11	View looking upstream at outlet works stilling basin left chute block underdrain. The drain is clear and flowing. Note edge relief of the chute block and the exposed vertical rebar on the left side of block. Concrete erosion of block is approximately 1.5 to 2 inches.....	14
A-12	View of outlet works stilling basin showing 3-inch diameter aggregate still attached to concrete matrix. Erosion of floor is approximately 4 inches. Note exposed rebar on the right side of the photograph.....	15
A-13	View looking downstream at far left dentate showing the general condition of outlet works stilling basin dentates. All dentates were in good condition with well defined edges and corners. No chipping of edges was noted.....	15
A-14	View of outlet works stilling basin showing larger exposed transverse rebar and lower longitudinal rebar. Erosion of floor in this area is approximately 6.5 inches. Lack of rust accumulation on rebar indicates active scour of basin floor .....	16
A-15	Aerial view of the downstream face of Enid Dam .....	17
A-16	Plan and profile of the outlet works stilling basin.....	18
A-17	Abrasion erosion in the north passage of the stilling basin.....	20
A-18	Stilling basin cross sections .....	21
A-19	View of the completed energy dissipation structure for Elkhead Creek Dam with 42-inch diameter fixed-cone valve in background .....	24
A-20	Plan and profile of the stilling basin.....	26
A-21	View of 42-inch diameter fixed-cone valve under low flow conditions .....	27
A-22	View of 42-inch diameter fixed-cone valve discharging at about 20 ft <sup>3</sup> /s.....	27
A-23	View of 18-inch diameter jet-flow gate discharging at about 50 to 70 ft <sup>3</sup> /s (near maximum discharge capacity) .....	28
A-24	View of outlet channel from energy dissipation structure.....	28
A-25	Overall view of completed dam modifications from downstream right abutment. The outlet works stilling basin is located in the left center of the figure .....	31
A-26	Construction crew installing forms for concrete placement of the stilling basin wingwalls.....	33

A-27	View looking upstream at the completed outlet works stilling basin and discharge channel. The structure just to the right of the stilling basin is a toe drain inspection well .....	33
A-28	Guadalupe River Project Design Schematic .....	35
A-29	Culvert Under Sobrato Business Park .....	36
A-30	Eroded upstream bank.....	36
A-31	Uplifted CCM mats near the bridge pier.....	37
A-32	Uplifted blocks with loss of granular filter material.....	38
A-33	Abraded concrete block surfaces.....	38
A-34	Aerial view of Kinzua Dam.....	41
A-35	Stilling basin plan .....	42
A-36	Stilling basin profile .....	43
A-37	Abrasion erosion of the stilling basin slab .....	45
A-38	Abrasion erosion of stilling basin slab. Note the constructed cellular cofferdam that encloses a portion of the basin .....	45
A-39	Baffle pier damaged by abrasion erosion .....	46
A-40	General view of repair operations .....	47
A-41	Stilling basin profile with debris trap .....	50
A-42	Details of the debris trap .....	51
A-43	Aerial view of Lucky Peak Dam. The arrow denotes the location of the six slide gates and flip buckets .....	53
A-44	Discharge emerging from flip bucket operations.....	54
A-45	High velocity flow being directed downstream into the plunge basin.....	55
A-46	Operation of the flip bucket caused significant icing due to water vapor... 55	
A-47	Discharge from the upstream slide gate resulted in significant cavitation damage to the invert of the flip bucket.....	56
A-48	Mason Dam as seen from the left abutment .....	58
A-49	Looking through the plexiglass sidewall of the model operating at 40 percent gate opening.....	60
A-50	Looking upstream at stilling basin model with ADV probe and deflector installed near the end of basin.....	60
A-51	Prototype flow deflector installation at Mason Dam in October 2002 .....	64
A-52	Aerial view of Mica Dam .....	68
A-53	Aerial view of Navajo Dam. The hollow-jet-valve outlet works basin is located next to the spillway stilling basin .....	70
A-54	Plan and profile of the hollow-jet stilling basin at Navajo Dam.....	74
A-55	Both hollow-jet valves being operated at near full discharge capacity.....	75
A-56	Original trapezoidal energy dissipator.....	76
A-57	Deflection in left wall of dissipator .....	77
A-58	Replacement structure.....	78
A-59	Aerial view of Norman Dam.....	80
A-60	The contractor created a small earthen dike in the downstream river channel to facilitate unwatering of the stilling basin.....	81
A-61	Most of the rocks and gravel were located on the downstream two-thirds of the basin floor.....	82

## Outlet Works Energy Dissipators

---

A-62	A crane was used to lower a front-end loader into the basin. The front-end loader was used to load debris into a metal container for removal .....	83
A-63	Shortly after unwatering, an excavated slope downstream and to the right of the stilling basin was observed to be experiencing cracking and developing a slump. There are pink flags marking the edge of the slump area .....	83
A-64	Cracking developing on slope near fence line .....	84
A-65	Slump area after cutting back slope. Sod is being placed to prevent erosion .....	84
A-66	After the basin was refilled, a sinkhole, approximately 3 feet deep and 3 feet wide appeared on the surface of the bank above the water line .....	85
A-67	Aerial view of Palisades Dam.....	87
A-68	Damage to chute block. Note the exposed reinforcement.....	88
A-69	Damage to splitter wall .....	89
A-70	Damage to dentate sill.....	89
A-71	Concrete being pumped to forms for repairs to dentate sill .....	91
A-72	Concrete being pumped for placement at floor.....	91
A-73	Closer view of concrete being placed .....	92
A-74	Stilling well at Palm Tree Creek Dam.....	94
A-75	Downstream face of Pineview Dam .....	96
A-76	Aerial view of Pomme de Terre Dam.....	98
A-77	Plan and profile of the outlet works stilling basin.....	99
A-78	Transition section for the basin.....	100
A-79	Abrasion erosion of in the transition section .....	101
A-80	Aerial view of the downstream face of Pomona Dam .....	103
A-81	Stilling basin plan and section .....	104
A-82	Unwatered stilling basin.....	105
A-83a	Stilling basin flow conditions at pool elevation 974 feet and discharge 500 ft <sup>3</sup> /s Stilling basin flow conditions at pool elevation 974 feet and discharge 1,000 ft <sup>3</sup> /s .....	106
A-83b	Stilling basin flow conditions at pool elevation 974 feet and discharge 1,000 ft <sup>3</sup> /s.....	107
A-84	Seven Oaks Dam.....	108
A-85	Profile of outlet works .....	109
A-86	Plunge basin.....	110
A-87	Profile of the plunge basin.....	111
A-88	The Seven Oaks Dam plunge basin apron and deflector details .....	111
A-89	Plunge basin in operation at Seven Oaks Dam .....	112
A-90	Schematic for Seven Oaks Dam minimum discharge line extension.....	113
A-91	Seven Oaks Dam minimum discharge line orifice design drawing .....	114
A-92	Downstream end with impact type energy dissipator (dry).....	115
A-93	Same energy dissipator with flow (120 ft <sup>3</sup> /s).....	115
A-94	Comparative pressure gradeline data from measurements versus calculations based on coefficients from Ball and Simmons (1963) and Tullis (1989) (USACE, 2008) .....	116

A-95	Time series data sample from steady state test (USACE, 2008).....	116
A-96	Orifice 3 frequency analysis.....	118
A-97	View of completed stilling basin for the new outlet works at the stream release facility at Standley Lake Dam.....	125
A-98	Plan and profile of the stilling basin.....	128
A-99	View looking downstream at the outfall channel during testing of one of the fixed-cone valves at 35 percent opening (147 ft <sup>3</sup> /s) .....	129
A-100	View looking downstream shown the right fixed-cone valve discharging at 35 percent opening (150 ft <sup>3</sup> /s).....	129
A-101	View of the stream release facility with both fixed-cone valves operating during testing at 20 percent opening (total of 167 ft <sup>3</sup> /s).....	130
A-102	View looking upstream at the stream release facility with both d-cone valves operating each at 20 percent opening (total of 167 ft <sup>3</sup> /s).....	130
A-103	Aerial view of Twin Lakes Dam, Colorado .....	132
A-104	Underdrain layout and path of CCTV inspection.....	136
A-105	Subsea mini video camera used to inspect small pipes. Note the 16 LED light sources surrounding lens .....	137
A-106	Typical condition of downstream face of outlet works stilling basin chute block and 6-inch diameter PVC drain outfall .....	137
A-107	Typical condition of drain outfall in downstream face of outlet works stilling basin chute block. Note minor damage to exposed edge of PVC drainpipe likely due to movement of material in basin during releases .....	138
A-108	View of the first bend inside Underdrain No. 1 (rightmost drain) in the outlet works stilling basin. Image was taken from pipe inspection video.....	139
A-109	View looking vertically downward at the second bend inside Underdrain No. 1 (rightmost drain) in the outlet works stilling basin.....	139
A-110	Isolated gravel in Underdrain No. 1 at T-intersection with pipe just downstream of second bend (location where pipe becomes horizontal)..	140
A-111	Visible rupture (upper arrow) in the side of the pipe wall of Underdrain No. 2 at the second bend. Lower arrow indicates visible entrance of upstream drain beneath the chute .....	140
A-112	Typical condition of Underdrain Nos. 2 and 3 downstream of the second bend, where camera could no longer be advanced.....	141
A-113	Underdrain No. 6 showing cobble blocking the 6-inch diameter PVC pipe just below the second bend .....	141
A-114	Cobble located in left outlet works bay near chute block. Large arrow indicates location where erosion of downstream corner/edge of chute block and floor slab are visible (Note joint along base of chute block at original floor slab denoted by small arrow).....	142
A-115	Localized erosion between two chute blocks in the outlet works left bay. Note that the ruler is resting on concrete at each chute block and spanning (about 2½ inches above concrete) eroded area in the floor.....	142
A-116	Damage to outlet works stilling basin floor.....	144



## Outlet Works Energy Dissipators

---

A-117	View of river outlet works stilling basin from left side. Arrows denote approximate location (on right wall) of exposed reinforcing steel .....	144
A-118	Plan of the stilling basin .....	146
A-119	Profile of the stilling basin .....	146
A-120	Close-up of right wall of river outlet works stilling basin. Arrows denote area of staining from hydraulic jump which roughly corresponds to area with exposed reinforcing steel in floor .....	147
A-121	Abrasion erosion which occurred on the basin floor .....	147
A-122	Vibration caused the conical openings around the portion of bars remaining in concrete .....	148
A-123	The exposed aggregate has been polished smooth by erosion .....	149
A-124	River outlet works stilling basin and control house at Virginia Smith Dam .....	152
A-125	The depression is being probed to determine its depth .....	154
A-126	Drill crew drilling a hole in right bay of stilling basin .....	155
A-127	Grout pumps located at access road by gate house. White pump was used for grouting and the orange pump was on site as backup pump .....	157
A-128	Grouting of the upstream chute .....	157
A-129	Barge used to monitor for grout blowout through foundation .....	159
A-130	Aerial view of Xiaolangdi Dam .....	161

## Common Abbreviations

AASHTO, American Association of State Highway and Transportation Officials  
ACB, articulated concrete block  
ACER, Assistant Commissioner–Engineering and Research  
ACI, American Concrete Institute  
ADCI, Association of Diving Contractors International  
ADV, acoustic Doppler velocimeter  
AEA, air-entraining admixture  
ARS, Agricultural Research Service  
ASAE, American Society of Agricultural Engineers  
ASCE, American Society of Civil Engineers  
ASDSO, Association of State Dam Safety Officials  
ASME, American Society of Mechanical Engineers  
ASTM, ASTM International  
ATV, all-terrain vehicle  
CCANZ, Cement and Concrete Association of New Zealand  
CCM, cellular concrete mats  
CCTV, closed circuit television  
CDOT, Colorado Division of Transportation  
CFD, computational fluid dynamics  
CMP, corrugated metal pipe  
CPR, cardiopulmonary resuscitation  
CRD, Concrete Research Division  
CSU, Colorado State University  
DB, decibels  
DOT, Department of Transportation  
DVD, digital versatile disc  
DWRE, Diplomat of Water Resources Engineer  
EM, Engineer Manual  
EPDM, ethylene propylene diene monomer  
ER, Engineer Regulation  
ERDC, Engineering Research and Development Center  
FE, Fundamentals of Engineering  
FEMA, Federal Emergency Management Agency  
FERC, Federal Energy Regulatory Commission  
FHWA, Federal Highway Administration  
H, heavy (gradation)  
HCFCD, Harris County Flood Control District

## Outlet Works Energy Dissipators

---

HDPE, high density polyethylene  
HEC, Hydraulic Engineering Circular  
HEC-RAS, Hydraulic Engineering Centers–River Analysis Section  
hp, horsepower  
IAHR, International Association of Hydro-Environment Engineering and Research  
ICOLD, International Commission of Large Dams  
IDF, inflow design flood  
JHA, job hazard analysis  
kHz, kilohertz  
L, light (gradation)  
LED, light-emitting diode  
LOTO, lockout tag out  
M, medium (gradation)  
MCE, maximum credible earthquake  
MDLE, minimum discharge line extension  
MHz, megahertz  
MW, megawatt  
NCDENR, North Carolina Department of Environment and Natural Resources  
NDSRB, National Dam Safety Review Board  
NDT, nondestructive testing  
NEH, National Engineering Handbook  
NRCS, Natural Resources Conservation Service  
NZSOLD, New Zealand Society on Large Dams  
O&M, operation and maintenance  
OSHA, Occupational Safety and Health Administration  
PDF, portable document format  
PE, Professional Engineer  
PFMA, potential failure modes analysis  
PMF, probable maximum flood  
PVC, polyvinyl chloride  
PWD, Public Works Department  
Reclamation, Bureau of Reclamation  
REMR, repair, evaluation, maintenance, and rehabilitation  
ROV, remotely operated vehicle  
ROW, river outlet works  
SAF, Saint Anthony Falls  
SDC, Strategic Development Council  
SEO, State Engineer’s Office  
STAAD, Structural Analysis and Design (software)  
TADS, Training Aids for Dam Safety  
UDFCD, Urban Drainage and Flood Control District  
USACE, U.S. Army Corps of Engineers  
USDA-NRCS, United States Department of Agriculture, Natural Resources Conservation Service  
USGS, United States Geological Survey

VH, very heavy (gradation)

VHS, video home system

VL, very light (gradation)

WES, Waterways Experiment Station

WVDOH, West Virginia Department of Highways

## Conversion Factors To the International System of Units (SI) (Metric)

Pound-foot measurements in this manual can be converted to SI measurements by multiplying by the following factors:

Multiply	By	To obtain
acre-feet	1233.489	cubic meters
cubic feet	0.028317	cubic meters
cubic feet per second	0.028317	cubic meters per second
cubic inches	16.38706	cubic centimeters
degrees Fahrenheit	$(^{\circ}\text{F}-32)/1.8$	degrees Celsius
feet	0.304800	meters
feet per second	0.304800	meters per second
gallons	0.003785	cubic meters
gallons	3.785412	liters
gallons per minute	0.000063	cubic meters per second
gallons per minute	0.063090	liters per second
inches	2.540000	centimeters
miles	1.609344	kilometers
pounds	0.453592	kilograms
pounds per cubic foot	16.01846	kilograms per cubic meter
pounds per square foot	4.882428	kilograms per square meter
pounds per square inch	6.894757	kilopascals
pounds per square inch	6894.757	pascals
square feet	0.092903	square meters
square inches	6.451600	square centimeters

## Symbols

- $A$ , cross-sectional area  
 $A_1$ , inside area of main pipe upstream of the orifice (ft<sup>2</sup>)  
 $A_2$ , main pipe area (ft<sup>2</sup>)  
 $A_o$ , orifice area  
 $A_p$ , inside area of main pipe surrounding the orifices assuming the conduit diameter is the same upstream and downstream of the orifice (ft<sup>2</sup>)  
 $A_r$ ,  $Q/V$ , required area of flow at allowable velocity (ft<sup>2</sup>)  
 $A_{v_c}$ , flow area of vena contracta  
 $b$ , stilling well width  
 $C_c$ , contraction coefficient  
 $C_{d_b}$ , coefficient of discharge  
 $CD$ , discharge coefficient based on area of pipe  
 $CD_o$ , discharge coefficient for orifice meter  
 $C_o$ , tailwater parameter  
 $C_{rad}$ , function of radius of orifice edge to orifice diameter (eq. 25)  
 $C_v$ , coefficient of velocity related to Reynolds number  
 $d$ , stilling well depth (chapter 5)  
 $d_t$ , theoretical depth of incoming flow (ft)  
 $d/b$ , ultimate scour depth below tailwater (ft)  
 $d_1$ , equivalent depth (ft)  
 $d_c$ ,  $D_c$ , critical depth of flow (ft)  
 $D$ , conduit diameter (section 6.2 and eq. 12)  
 $D$ , equivalent conduit diameter (p. 184)  
 $D$ , main circular pipe inside diameter (ft) (eq. 26)  
 $D$ , ultimate scour depth below tailwater level (ft) (eq. 11)  
 $D'$ , adjusted conduit rise (ft)  
 $D_1$ , inside diameter of pipe upstream of orifice (ft) (eq. 20)  
 $D_1, y_1, d_1$ , depth of flow entering the basin before (upstream of) the jump (ft)  
 $D_{100}$ , riprap size for which 100% is smaller by weight  
 $D_{100max}$ , maximum  $D_{100}$  stone diameter  
 $D_{15B}$ , particle size diameter in millimeters of the 15th percentile passing grain size of the base soil  
 $D_{15B}$ , particle size diameter in millimeters of the 15th percentile passing grain size of the base soil  
 $D_{15F}$ , particle size diameter in millimeters of the 15th percentile passing grain size of the filter  
 $D_2$ , hydraulic diameter of downstream conduit (ft) (eq. 13)

- $D_2$ , inside diameter of conduit in expansion zone, or downstream of sudden expansion (eq. 15a)
- $D_2$ , inside diameter of downstream conduit (eqs. 22, 23a, and 24)
- $D_2, y_2, d_2$ , depth of flow after (downstream of) the jump (also called conjugate or sequent depth) (ft)
- $D_{20}$ , riprap size for which 20% is smaller by weight
- $D_{50}$  or  $d_{50}$ , riprap size for which 50% is smaller by weight (ft)
- $D_{50max}$ , maximum  $D_{50}$  stone diameter
- $D_{85B}$ , particle size diameter in millimeters of the 85th percentile passing grain size of the base soil
- $D_m$ , diameter of pipes tested in lab
- $D_o$ , conduit diameter (sections 5.2.1 and 5.2.2)
- $D_o$ , inside diameter of approach conduit upstream of expansion zone (ft) (eq. 14)
- $D_o$ , orifice diameter (ft) (eq. 17a)
- $D_p$ , diameter of prototype pipe
- $D_w$ , stilling well diameter
- EGL, energy grade line
- $f$ , Darcy-Weisbach conduit friction coefficient
- $f'_c$ , compressive strength of concrete (lb/in<sup>2</sup>)
- $f_y$ , yield stress of reinforcement (lb/in<sup>2</sup>)
- $F_1, F$ , Froude number of incoming flow
- $g$ , acceleration due to gravity (32.2 ft/s<sup>2</sup>)
- $h$ , head (ft)
- $h_o$ , dissipator pool depth (ft)
- $H$ , baffle pier height (ft)
- $H$ , elevation difference between from the reservoir and tailwater (ft) (eq. 11)
- $H$ , horizontal
- $H_1$ , pressure head upstream (lb/ft)
- $H_2$ , pressure head downstream (lb/ft)
- $H_o$ , pressure head downstream of orifice after full flow recovery
- HGL, hydraulic grade line
- HL, head loss generated by a sudden expansion or orifice
- $H_{min}$ , minimum head (ft)
- $H_o$ , pressure head upstream of orifice
- $H_v$ , vapor pressure head,  $P_v/\gamma$  ( $P_v$ , vapor pressure)
- $K_o$ , orifice loss coefficient applied to main pipe area
- $L$ , length of conduit between locations 1 and 2 (ft) (eq. 13)
- $L_A$ , apron length (ft)
- $L_B$ , basin length (ft)
- $L_r$ , length ratio
- $L_s$ , dissipator length (ft)
- $P$ , pressure at flow surface (lb/ft<sup>2</sup>) (eq. 6)
- $P$ , pressure (lb/ft<sup>2</sup>) (eq. 13)
- $P_1$ , pressure upstream (lb/ft<sup>2</sup>) (eq. 26)
- $P_1$ , pressure upstream of orifice (lb/ft<sup>2</sup>) (eqs. 18 and 19)

- $P_1$ , prototype gauge pressure upstream of sudden enlargement (eq. 37)  
 $P_{1m}$ , model upstream pressure (lb/in<sup>2</sup>)  
 $P_2$ , pressure downstream (lb/ft<sup>2</sup>) (eq. 26)  
 $P_b$ , barometric pressure  
 $P_b$ , baseline pressure  
 $P_g$ , gauge pressure  
 $PSE$ , pressure scale effect from reference lab results to prototype scale  
 $P_v$ , absolute vapor pressure (lb/ft<sup>2</sup>) (eq. 26)  
 $P_w$ , vapor pressure of water (lb/ft<sup>2</sup>) (eq. 6)  
 $P_{vg}$ , gauge vapor pressure (lb/ft<sup>2</sup>) (eq. 26)  
 $P_{vgp}$ , prototype gauge vapor pressure at prototype scale (lb/in<sup>2</sup>) (eq. 37)  
 $P_{vgm}$ , model gauge vapor pressure (lb/in<sup>2</sup>)  
 $q$ , unit discharge (ft<sup>3</sup>/s per foot of width)  
 $Q$ , flow rate or discharge (ft<sup>3</sup>/s)  
 $Q_r$ , discharge ratio  
 $r$ , radius of orifice edge (ft) (eq. 25a)  
 $SSE$ , size scale effect from reference lab results to prototype scale  
 $T$ , stilling well depth  
 $TW$ , tailwater depth (ft)  
 $v_1$ , velocity of flow entering the basin upstream of the jump (ft/s)  
 $V$ , average flow velocity (ft/s) (eq. 6)  
 $V$ , average velocity in pipeline (ft/s) (eq. 13)  
 $V$ , theoretical velocity (ft/s) (eqs. 7 and 8)  
 $V$ , vertical  
 $V_0$ , velocity of jet upstream of sudden expansion (ft/s) (eqs. 14 and 15)  
 $V_1$ , approach velocity (ft/s) (eq. 44)  
 $V_1$ , velocity upstream of orifice (ft/s) (eq. 19)  
 $V_2$ , velocity of fully developed flow in downstream expansion zone conduit (ft/s)  
 $V_c$ , critical velocity (ft/s)  
 $V_o$ , conduit outlet velocity (ft/s)  
 $V_r$ , velocity ratio  
 $V_{vc}$ , vena contracta velocity (ft/s)  
 $W$ , chute width (ft) (eq. 43)  
 $W$ , width of basin (ft) (eqs. 9 and 10)  
 $W_{50}$ , median stone weight  
 $W_B$ , basin width at downstream end (ft)  
 $W_{max}$ , maximum stone weight  
 $W_{min}$ , minimum stone weight  
 $W_o$ , diameter of conduit (ft) (p. 189)  
 $y_1, y_2$ , depths of flow before and after the jump (ft)  
 $y_o$ , equivalent bank (outlet) depth (ft)  
 $y_n$ , normal (supercritical) depth in the conduit (ft)  
 $y_o$ , brink depth (ft)



$Z$ , centerline elevation (ft)

$\beta$ , ratio of orifice to pipe diameter (eq. 23a)

$\gamma$ , unit weight of water (lb/ft<sup>3</sup>)

$\theta$ , ratio of areas for orifice and inside diameter of pipe

$\rho$ , density of water (lb-s<sup>2</sup>/ft<sup>4</sup>)

$\sigma$ , cavitation index (eq. 6)

$\sigma$ , dimensionless system cavitation coefficient (for orifice) (eq. 26)

$\sigma_{cb}$ , choking cavitation

$\sigma_{cr}$ , critical cavitation

$\sigma_{cr}$ , reference critical cavitation coefficient from lab tests

$\sigma_i$ , incipient cavitation

$\sigma_{id}$ , incipient damage cavitation

$\sigma_{idm}$ , reference incipient damage cavitation coefficient from lab tests

$\sigma_{im}$ , reference incipient cavitation coefficient from lab tests

## AASHTO Standards

<u>AASHTO Standard</u>	<u>Title</u>
M288	Standard Specification for Geotextile Specification for Highway Applications, Single User Digital Publication

## ASTM Standards

<u>ASTM Standard</u>	<u>Title</u>
C 42	Standard Test Method for Obtaining and Testing Drilled Cores and Sawed Beams of Concrete
C 127	Standard Test Method for Density, Relative Density (Specific Gravity), and Absorption of Coarse Aggregate
C 295	Standard Guide for Petrographic Examination of Aggregates for Concrete
C 823	Standard Practice for Examination and Sampling of Hardened Concrete in Constructions
C 856	Standard Practice for Petrographic Examination of Hardened Concrete in Constructions
D 4992	Standard Practice for Evaluation of Rock to be Used for Erosion Control
D 5312	Standard Test Method for Evaluation of Durability of Rock for Erosion Control Under Freezing and Thawing Conditions
D 6684	Standard Specification for Materials and Manufacture of Articulating Concrete Block (ACB) Revetment Systems
D 6884	Standard Practice for Installation of Articulating Concrete Block (ACB) Revetment Systems
D 7277	Standard Test Method for Performance Testing of Articulating Concrete Block (ACB) Revetment Systems for Hydraulic Stability in Open Channel Flow

## Websites

The following websites can provide additional information and publications related to dams and outlet works energy dissipators:

American Society of Civil Engineers: <http://www.asce.org>

American Society of Civil Engineers Publications: <http://www.pubs.asce.org>

Association of State Dam Safety Officials: <http://www.damsafety.org>

Bureau of Reclamation: <http://www.usbr.gov>

Bureau of Reclamation Publications:

[http://www.usbr.gov/pmts/hydraulics\\_lab/pubs/index.cfm](http://www.usbr.gov/pmts/hydraulics_lab/pubs/index.cfm)

Canadian Dam Association: <http://www.cda.ca>

Federal Emergency Management Agency:

<http://www.fema.gov/plan/prevent/damfailure>

Federal Emergency Management Agency Publications:

<http://www.fema.gov/plan/prevent/damfailure/publications.shtm>

Federal Energy Regulatory Commission:

<http://www.ferc.gov/industries/hydropower/safety.asp>

International Commission on Large Dams: <http://www.icolc-cigb.net>

National Performance of Dams Program: <http://npdp.stanford.edu>

Natural Resources Conservation Service: <http://www.nrcs.usda.gov/technical/eng>

Natural Resources Conservation Service Publications:

<http://directives.sc.egov.usda.gov>

U.S. Army Corps of Engineers: <http://www.usace.army.mil>

U.S. Army Corps of Engineers Publications: <http://140.194.76.129/publications>

United States Society on Dams: <http://www.usdams.org>



# Introduction

An outlet works is a combination of structures and equipment required for the safe operation and control of water released from a reservoir to serve various purposes (i.e., regulating stream flow and quality; releasing floodwater, providing irrigation, municipal, and/or industrial water). The outlet works typically consists of an intake structure, conduit, control house, gate chamber, regulating valve(s) or gates(s), and an energy dissipation structure. [Figure 1](#) illustrates the common arrangements and components of an outlet works. For guidance on the design and construction of an outlet works, see [FEMA's \*Technical Manual: Conduits through Embankment Dams\* \(2005\)](#).

This manual will focus on the methods by which energy resulting from the release of water through the outlet works is dissipated for safe discharge downstream. The theory involved with energy dissipation can best be explained with the hydraulic jump. Flowing water emerging from an outlet works can be in one of two states: subcritical or supercritical. With subcritical flow, waves travel upstream. With supercritical flow, all waves migrate downstream. The transition between these two states is called “critical flow.” When water at high velocity (supercritical) discharges into a zone of lower velocity (subcritical), a rather abrupt rise (a step or standing wave) occurs on the liquid surface. This abrupt rise is called a “hydraulic jump.” The hydraulic jump is a commonly used method of energy dissipation. The cross-sectional flow area of the rapidly flowing water increases (which, in an open channel, appears as an increase in elevation), converting some of the initial kinetic energy of flow into a lower kinetic energy, an increased potential energy, and the remainder to irreversible losses (turbulence, which ultimately converts the energy to heat). The phenomenon depends upon the initial velocity of the flow. If the initial velocity is below the critical velocity, no jump is possible. For relatively low initial flow velocities, above the critical velocity, an undulating wave appears. As the flow velocity increases, the transition grows more abrupt, and at high enough velocities the front breaks and curls back upon itself. This rise can be accompanied by violent turbulence, eddying, air entrainment, and surface undulations. [Figure 2](#) shows an example of a hydraulic jump occurring in an outlet works energy dissipator.

The hydraulic jump is a naturally occurring phenomenon in streams and watercourses. The hydraulic jump has been recognized for centuries and is the most prevalent type of energy dissipator. Leonardo da Vinci sketched a plunging jet-flow at a pipe outlet, “impact of water on water,” in one of his notebooks in the 15th century; Venturi wrote about it in the 18th century; and Giorgio Bidone of the

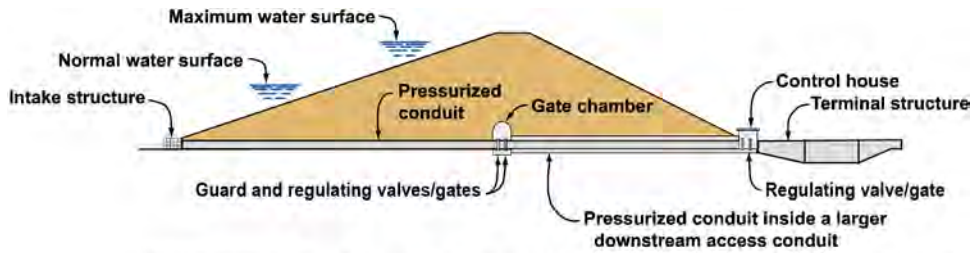

**Arrangement 1—Intermediate control with downstream access.**—The control feature is located at an intermediate point within the conduit.

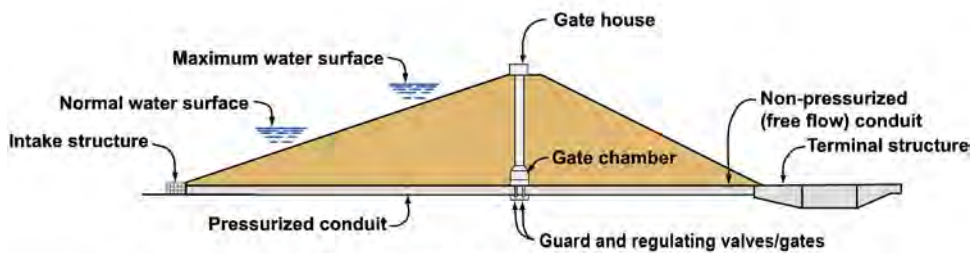

**Arrangement 2—Intermediate control without downstream access.**—The control feature is located at an intermediate point within the conduit.

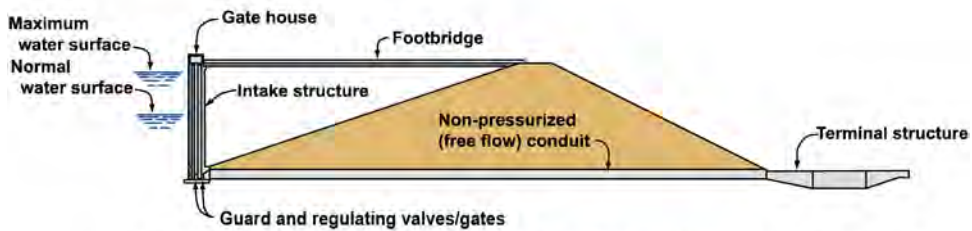

**Arrangement 3—Upstream control.**—The control feature is located at the upstream end of the conduit.

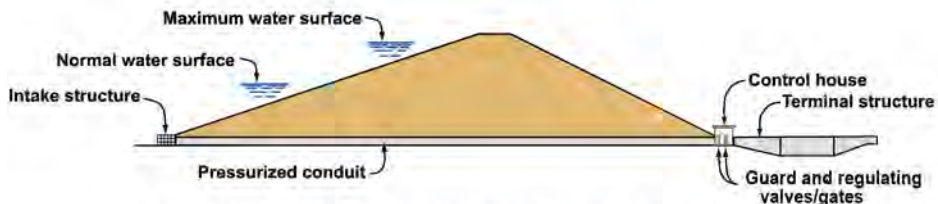

**Arrangement 4—Downstream control.**—The control feature is located at the downstream end of the conduit.

Figure 1.—Alternative arrangements for guard and regulating valves and gates for embankment dams.



Figure 2.—A hydraulic jump occurring in an outlet works energy dissipator.

University of Turin (Italy) “discovered” the jump at about the same time. However, none of them were interested in it as an energy dissipator. Late in the 19th century and early in the 20th century, research was conducted in the United States at Lehigh University, Worcester Polytechnic University, Cornell University, the University of California, and probably many others. Advanced research also was accomplished at many European universities.

There are many types of energy dissipation structures. Some, such as the hydraulic jump stilling basin, are designed to dissipate energy within the concrete structure itself. Others, such as the plunge basin, depend on energy dissipation in the natural channel located downstream. The first chapter of this manual briefly describes the various types of structures used as outlet works energy dissipators.

[Chapters 2](#) through [8](#) provide guidance on the design and construction of the various types of energy dissipators. [Chapter 9](#) discusses riprap and concrete blocks used for erosion protection. [Chapter 10](#) discusses the use of baffled drops. [Chapter 11](#) discusses frequency of inspection, events that require initiation of inspection, and the available methods of inspection. [Chapter 12](#) discusses maintenance and repair. [Chapter 13](#) discusses public safety and prevention of vandalism. The appendix contains case histories elaborating on topics discussed in the manual.



## Outlet Works Energy Dissipators

---

Energy dissipation is typically required for outlet works associated with embankment and concrete dams where flow emerges at a high velocity in a near horizontal direction. While many of the energy dissipators discussed in this manual can be used for embankment dams, valve and gate applications are more common at concrete dams. At some dams, site conditions and economics may favor combining the outlet works and spillway energy dissipation structures (figure 3). However, this may result in more frequent use of the spillway stilling basin and increase the chances of erosional damage, if other unfavorable conditions exist.

Outlet works and spillway energy dissipators often experience similar loading conditions. However, outlet works dissipation structures typically operate more frequently (often at or near their design discharge) and operate for longer durations. For these reasons, they require a more conservative design. Special consideration is required to avoid flow surface damage from abrasion-erosion, cavitation, vibration, and undercutting. Although the energy dissipator greatly reduces the energy of high head releases from the outlet works, enough residual energy usually remains at the end of the dissipator to cause scour from eddies and back currents. If problems develop during the operation of an outlet works energy dissipator, the upstream valves or gates can usually be closed to allow for inspection and repairs. Often, this is not the case for uncontrolled spillway energy dissipator required to pass large flows during a hydrologic event.

Not all dams require an outlet works energy dissipation structure. If a dissipation structure is not required, the designer must carefully investigate any localized flow



Figure 3.—An outlet works discharging into a spillway stilling basin.

conditions that can undermine the end of the chute, conduit, or tunnel. For example, the rock formation at the end of these structures may appear to be sound, erosion resistant, and able to withstand the computed impact velocities and pressures (figure 4). However, after a few seasons of operation, the rock may degrade resulting in progressive erosion or dynamic extraction of pieces of jointed rock. Also, operation of the outlet works may expose the rock to air, allowing for rapid weathering.



Figure 4.—If the downstream formation consists of competent rock where the potential for erosion is negligible, an energy dissipator may not be required.



# Chapter 1

## General

Selection of the appropriate energy dissipator for each given application is a critical design consideration. Each situation is unique, and each energy dissipator has certain limitations. The selection of the proper energy dissipator must consider:

- The site topography and geology.
- The energy content and unit discharge of the flow entering the dissipator.
- Number of outlets involved.
- Duration and frequency of flow.
- Compatibility with the conduit, tunnel, valve, or gate from which flow is emerging.
- Restrictions on spray and icing.
- The amount of energy that must be dissipated to control downstream channel erosion.
- Tailwater conditions for the range of discharges.
- Alignment and location with respect to the toe of the dam and other features.
- Requirements for periodic examination.
- Water quality.
- Economic concerns.
- Environmental concerns.

While selecting the proper design to meet the majority of these requirements is often straightforward, certain situations may occur where one or more aspects dominate the design selection.

## Outlet Works Energy Dissipators

---

Careful attention to detail during planning and design can eliminate a wide variety of problems that commonly occur at outlet works energy dissipators. Designers should give proper attention to hydraulic, structural, and mechanical design details to provide a low maintenance and cost effective energy dissipator. A poorly designed energy dissipator can result in:

- Excessive turbulence or sweep-out of the hydraulic jump causing downstream erosion of the channel.
- Structural damage to stilling basin or downstream structures.
- Excessive maintenance.
- Worker safety issues.

Common problems associated with energy dissipators include:

- Insufficient or varying tailwater, a low angle jet trajectory entering the basin or channel, inadequately sized riprap, or insufficient plunge pool or channel depth leading to excessive turbulence or downstream channel erosion.
- A high velocity, concentrated jet impacting concrete surfaces, leading to abrasion erosion of stilling basin floors from rock or other debris circulating in the flow within the stilling basin.
- A high velocity, concentrated jet impacting concrete surfaces leading to cavitation damage.
- Insufficient air supply to submerged valves, fixed-cone valves, or other free discharge valves leading to cavitation and surging flow in stilling basins and outlet conduits.
- Nonuniform velocity distribution of flow entering the basin. If flow does not enter the basin uniformly across the basin, backflow will be initiated from downstream that can pull rocks and available debris into the basin. The materials pulled into the basin can cause abrasion erosion of floor, walls, and appurtenances.
- Nonsymmetrical operation of multiple gate outlets leading to eddies and to debris being pulled into the basin.

These problems can be eliminated or reduced by a carefully engineered design.

Design methods for many of the energy dissipators have been developed and standardized by the major dam-building agencies. Computational and physical hydraulic model testing have been performed making the operational characteristics predictable. However, where the need exists to extrapolate beyond the limits of these designs or where new innovative concepts require investigation, further model testing is recommended. For these cases, model tests may result in improved performance and lower construction, maintenance, and replacement costs. Model tests should be made for the full discharge range. Experience has shown that damage can occur at low, medium, and high discharges.

Typical loadings considered in the design of an outlet works energy dissipator include:

- Dead loads.
- Static live loads (e.g., water pressures, uplift, backfill, temperature, and frost heave).
- Dynamic loads (e.g., seismic, impact, vibration, and pulsating).
- Other loads (e.g., landslides, construction, and unwatering).

The following provides brief descriptions of the energy dissipators and erosion protection discussed in this manual:

- *Hydraulic jump stilling basin.*—In the hydraulic jump stilling basin, water flowing at higher than critical velocity is forced into a hydraulic jump to dissipate energy in the resulting turbulence. The jump has distinctive characteristics and assumes a definite form depending on the energy and depth of the flow as it reduces the exit velocity to a subcritical state. The stilling basin is typically connected to the outlet works conduit portal with a transition chute. Hydraulic jump stilling basins operate satisfactorily for Froude numbers in the range of 4 to 20. The hydraulic jump basin is often favored by designers since it has been extensively studied and is well documented. A properly designed basin can usually dissipate 50 to 70 percent of the energy in the flow within the basin. Particular attention is required to ensure the velocity distribution of flow entering the basin is uniform. Tailwater is required for successful operation of hydraulic jump stilling basins. [Figure 5](#) shows a hydraulic jump stilling basin. For guidance on hydraulic jump stilling basins, see [chapter 2](#).
- *Impact basin.*—The impact basin directs the flow into a stationary concrete baffle located within the structure that diverts the flow in all directions, causing the energy in the flow to be dissipated. The impact basin is often used in low head situations and is considered to be more effective than the hydraulic jump basin to dissipate energy, resulting in smaller and more economical structures. The





Figure 5.—Hydraulic jump stilling basin. Note the hydraulic jump flow pattern on the interior surface of the basin walls.

impact basin requires little or no tailwater for successful performance. [Figure 6](#) shows an impact basin. For guidance on impact basins, see [chapter 3](#).

- *Plunge basin.*—The plunge basin is commonly used with a cantilevered outlet pipe that is either gated or free flowing ([figure 7](#)). Water scours plunge basins to a depth that is related to the height of the fall, the depth of the tailwater, concentration of the flow, and the erodibility of the bottom of the basin. The abrading action from flow into the basin may be extremely aggressive. The basin lining must be designed to ensure that it will provide acceptable performance for the life of the project. The plunge basin is sometimes a companion feature to a flip bucket ([figure 8](#)). The flip bucket directs free-falling, high velocity flow into a plunge basin located far enough downstream from the toe of the dam so the energy can be dissipated without endangering the dam or surrounding structures. For guidance on plunge basins, see [chapter 4](#).
- *Stilling well.*—In a stilling well, the incoming flow can be directed vertically downward into the bottom of the well or horizontally into the well. The energy dissipation is achieved by the expansion in the enlarged stilling well, the impact of the fluid on the base and walls in the stilling well, and the change in momentum resulting from redirection of flow. The flow rises up and emerges from the top of the well, which is often flush with the outlet channel.



Figure 6.—A stationary baffle in an impact basin.



Figure 7.—A riprap-lined plunge basin downstream from a cantilevered pipe.

Horizontal stilling wells are not as common as vertical stilling wells, but can be used to improve access, reduce dewatering, and reduce excavation requirements. Stilling wells often utilize fixed-cone and sleeve valves. [Figure 9](#) shows a stilling well containing a sleeve valve. For guidance on stilling wells, see [chapter 5](#).

- *Conduit outlet expansion.*—The conduit outlet expansion is a relatively low cost energy dissipation structure that is designed to contain the hydraulic jump within the confines of a flared transition structure between the outlet conduit





Figure 8.—Flow being discharged from a flip bucket into an unlined plunge basin.



Figure 9.—This 48-inch diameter perforated steel discharge pipe is located downstream of the sleeve valve in a stilling well. The 72 6-inch diameter openings are provided to more evenly distribute the flow from the sleeve valve into the well. The stilling well dissipates any remaining head after the sleeve valve and releases water into the downstream chute without any spray that may cause icing.

and the downstream channel. The conduit outlet expansion requires tailwater control and may be used for discharges with Froude numbers up to 2.0. The expansion is self-cleaning and does not tend to accumulate debris. The conduit

outlet expansion is typically used on low head structures. [Figure 10](#) shows a conduit outlet expansion. For guidance on conduit outlet expansions, see [chapter 6](#).

- *Valve and gate.*—The valve or gate is an integral component of the outlet works. The location, flow characteristics, and losses through the valve or gate must be considered when designing an energy dissipator. Some valves and gates provide relatively little energy dissipation (i.e., jet-flow gate, bonneted slide gate, etc.) whereas others can serve the dual function of control and energy dissipation (e.g., fixed-cone, ported sleeve, and Monovar valves). The location of the valve or gate in relation to the other outlet works features and the downstream channel significantly influences the effectiveness and efficiency of the valve or gate as an energy dissipator. [Figure 11](#) shows flow emerging from a fixed-cone valve (sometimes referred to as a Howell-Bunger valve). [Figure 12](#) shows an example of a clamshell gate. For guidance on valves and gates, see [chapter 7](#).
- *Sudden enlargement and inline orifice.*—A sudden enlargement has been used within or at the end of an outlet works conduit as an energy dissipator. However, at certain ranges of operating conditions, damage due to cavitation is possible. The inline orifice has also been used as an energy dissipator. Significant energy dissipation can be achieved by creating head loss with orifice plates located at specified intervals. However, the selection of the proper number and orifice diameters is critical in preventing damage due to cavitation. [Figure 13](#) shows an



Figure 10.—Conduit outlet expansion.





Figure 11.—Flow emerging from a Howell-Bunger valve.



Figure 12.—Clamshell gate.

example of an inline orifice. For guidance on sudden enlargements and inline orifices, see [chapter 8](#).

- *Riprap and concrete blocks.*—Riprap consists of a protective blanket of rock that is usually placed by machine to achieve a desired configuration. In some cases,

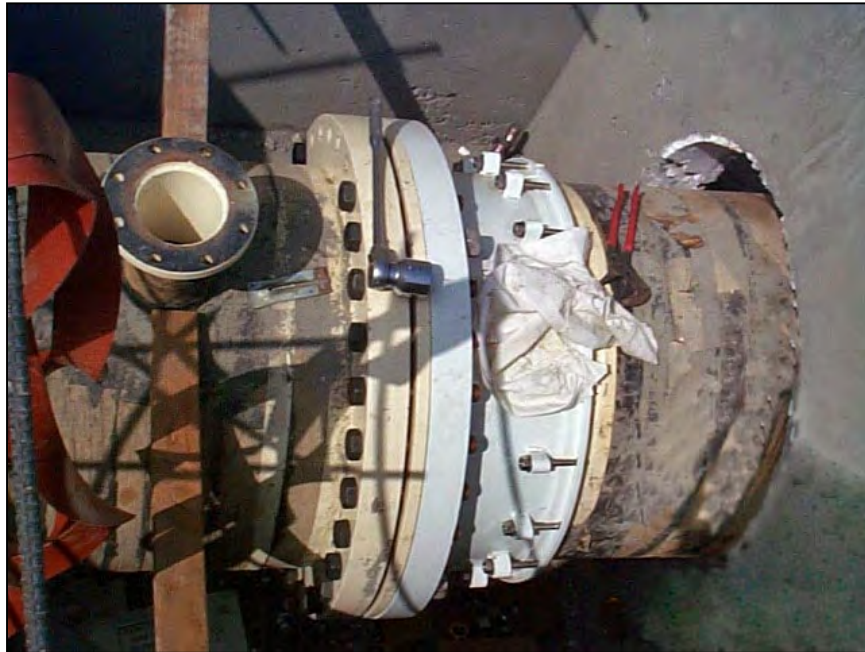

Figure 13.—Orifice pit and assembly with adjustable coupler, orifice plate, and downstream air release valve.

the riprap is grouted in place. The riprap should be placed on top of adequate bedding. A transitional riprap apron is necessary downstream of a concrete energy dissipator basin, if the flow velocity exceeds the allowable erosive stream velocity. Most concrete energy dissipator basins are designed to contain the hydraulic jump that typically occurs downstream of the outlet works portal. Theoretically, at the downstream end of the energy dissipator, the flow should be subcritical with a Froude number less than 1.0. However, this is not always the case, and the transitional riprap apron provides additional erosion protection. Properly anchored concrete blocks may be used as an end treatment downstream of the outlet works conduit or stilling basin. A concrete block system consists of a matrix of interconnected block units sufficient for erosion protection. Units are connected by geometric interlock and/or cables, geotextiles, or geogrids, and typically include a geotextile for subsoil retention. [Figure 14](#) shows an example of the concrete block system. For guidance on the use of riprap and concrete blocks, see [chapter 9](#).

- *Baffled drop.*—The baffled drop is used to provide dissipation of energy at changes in grade downstream from the energy dissipator. This serves a useful purpose in the outlet channel but is rarely used solely as an energy dissipator. Thus, the baffled drop should be considered an ancillary design feature. The energy dissipation occurs as the water flows over, around, and between the equally spaced concrete baffle blocks on the floor of the sloping chute. The baffle blocks prevent excessive flow acceleration and provide an acceptable



Figure 14.—Cable-tied concrete blocks.

terminal velocity. The baffled drop is often used in low head applications where widely fluctuating tailwater conditions must be accommodated. The baffled drop may become uneconomical for large flows and significant drops due to wide sections and the numerous blocks involved. Relatively wide sections are required to keep unit discharge low to limit baffles to an economical size. The baffled drop can be prone to debris collection at the baffles. [Figure 15](#) shows a baffled drop structure. For guidance on baffled drops, see [chapter 10](#).

### 1.1 Additional Design Considerations

[Table 1](#) presents important design considerations for each type of energy dissipator. Further details can be found in subsequent chapters in this manual.

The designer should understand the unique conditions involving outlet works energy dissipators that require special consideration. A few of these include:

- The outlet works typically operates within a defined range of discharges based on downstream needs or reservoir storage requirements, and the energy dissipator may not experience the maximum design loading. However, infrequent situations (reservoir evacuation or supplementing spillway releases) may arise that require the energy dissipator to experience the maximum loading.





Figure 15.—A baffled drop used for energy dissipation at a grade change.

- Even though the dissipation structure greatly reduces much of the energy, enough energy may remain to cause scour from eddies and back currents downstream from the structure.
- Energy dissipation structures must be designed to resist large dynamic loads from pulsating flow, which can lead to wall vibration and cause fatigue of concrete and reinforcing steel.
- Rapidly fluctuating downward pressures on the floor slab, combined with abnormally high or low uplift pressures, can produce vibrations and instability.
- Cavitation and abrasion (from circulation of sand, rocks, and other debris) can damage floors, walls, blocks, and end sills.
- Fluctuating tailwater conditions can affect stilling basin performance.

Unconventional types of energy dissipators may be required to satisfy unusual site conditions or may be necessary for construction reasons. In these situations, standardized designs may not be efficient or economical. With the departure from time-tested design guidance, the need for verification of performance by model study is prudent. Verification may require both mathematical and physical modeling.

## Outlet Works Energy Dissipators

Table 1.—Important design considerations for selected energy dissipators

Chap.	Energy dissipator	Froude number	Tail-water required	Special considerations	Limitations
2	Hydraulic jump basin type I	1.7-2.5	Yes	Uplift, vibration, cavitation, abrasion, and nitrogen supersaturation	Lengthy basin required to contain jump
2	Hydraulic jump basin type II	4.5-17	Yes	Uplift, vibration, cavitation, abrasion, and nitrogen supersaturation	Developed for incoming velocities >60 ft/s and unit discharges up to 500 ft <sup>3</sup> /s per foot width of basin
2	Hydraulic jump basin type III	4.5-17	Yes	Uplift, vibration, cavitation, abrasion, and nitrogen supersaturation	Limited to 60 ft/s incoming velocity
2	Hydraulic jump basin type IV	2.5-4.5	Yes	Wave action cannot be entirely dampened.	
2	Hydraulic jump basin type V	1.7-17	Yes	Uplift, vibration, cavitation, abrasion, and nitrogen supersaturation	Developed for large spillways
2	Saint Anthony Falls basin	1.7-17	Yes	Uplift, vibration, cavitation, abrasion, and nitrogen supersaturation	Has a lower factor of safety against sweepout than other hydraulic jump basins
2	U.S. Army Corps of Engineers (USACE) basin	4.5-17	Yes	Uplift, vibration, cavitation, abrasion, and nitrogen supersaturation	Limited to 60 ft/s incoming velocity
3	Impact basin type VI	1.1-10	No	The bottom of the baffle should be placed at the same level as the invert of the upstream conduit.	Limited to 50 ft/s incoming velocity and discharge up to 400 ft <sup>3</sup> /s
6	Conduit outlet expansion	<1-2	Yes	None	None
8	Sudden enlargement	Pres-surized flow	Yes	Cavitation, materials, minimum conduit length between head drops, vibration	Debris clogging, minimum conduit length for series
8	Inline orifice	Pres-surized flow	Yes	Cavitation, materials, minimum conduit length between head drops, vibration	Debris clogging, minimum conduit length for series

The energy dissipator should be sized to accommodate the full range of expected flows including routine releases as well as higher volume releases that may be required during an emergency drawdown. Recommended outlet works sizing criteria may be found in the Bureau of Reclamation's (Reclamation) *Criteria and Guidelines for Evacuating Storage Reservoirs and Sizing Low Level Outlet Works* (1990a). This publication

provides outlet works sizing criteria as a function of downstream hazard, project risk, mean monthly inflows, dam height, and reservoir storage. Generally, the energy dissipator design capacity may be sized to correspond to the discharge that results from having the valves or gates wide open at full reservoir head. However, in some cases, the ultimate outlet capacity may be greater than is required for emergency drawdown. This condition is commonly encountered on irrigation dams that are subject to a wide range of reservoir heads and have large outlet works that must be capable of sustaining operational releases at low reservoir pool levels. In this circumstance, the design capacity of the energy dissipator may be developed utilizing emergency drawdown criteria rather than ultimate outlet capacity.

## 1.2 Risk and Downstream Consequences

The guidance provided in this manual will assist the designer with developing solutions to the types of problems discussed in this chapter. Potential failure modes analysis (PFMA) and risk-informed concepts may assist with these problems as well.

PFMA is basically performed by a multi-disciplinary group familiar with the dam. The group evaluates the possible events leading to a dam failure mode based on the specifics of the dam in question. For example, what events would need to occur for the failure of an outlet works energy dissipator leading to dam failure? PFMA would examine various questions associated with the specific dam. The following is an example set of questions to consider (not an exhaustive list and may need to be expanded for site-specific conditions) in fully describing a potential failure mode:

- Does the outlet works have upstream control features to shut off the flow?
- Is the project manned or regularly monitored, so a problem can be observed and action be taken to prevent problems (like closing the gates)?
- If the project is unmanned, can the gates be remotely operated? If not, can personnel access the dam for the situation of concern? How long will access take?
- Will the gates operate as planned? Can the gates close under flow without power? Is there a backup power system or an emergency gate?
- Could the potential problem lead to a complete failure of the dam or just require repairs following the event (loss of the stilling basin, but not the dam)?
- How would the dam fail? Would the failure of the basin lead to a scour hole that causes the dam to become unstable and result in releasing the reservoir? Would the scour hole erode back through the dam leading to failure? Would scour lead to compromising the seepage defenses? All require specific



## Outlet Works Energy Dissipators

---

knowledge of the embankment and foundation materials; information on flood event routings including pool elevation and duration; outlet works discharge and duration; tailwater rating curve or conditions; and other information to make adequate judgments for the specific dam.

- Is there sufficient flood duration or reservoir storage to lead to a complete failure of the dam?
- What are the downstream consequences of the dam failure?

Answering these questions would assist in deciding if failure of the outlet works energy dissipator would progress into a dam safety concern.

Risk-informed decision making would include estimating the loading event when the energy dissipation would likely fail and the probability of failure for that loading event. Combining that with the likely consequences of the failure (whether the dam would fail or just the energy dissipator) provides more information on the importance to the overall dam safety of the structure. The overall risk estimate for this specific failure mode would be the product of the probability of the loading, the probability of the failure, and the consequence for a full range of flow conditions at outlet works energy dissipation structures.

A PFMA for energy dissipation would examine a number of potential failure modes including ball milling or abrasion erosion, damage from cavitation, hydraulic jacking, and sweep-out of a hydraulic jump. Reclamation is developing a best practices manual for all of these potential failure modes to help identify the likelihood of their occurrence. Reclamation uses this information in their expert elicitation process. The USACE is currently developing various “tools” for these potential failure modes (and for unusual failure modes not addressed by the tools) to assist in the estimation of probability of failure. Until these tools are finalized, the USACE will also be using an expert elicitation process.

The USACE has a few dams where the outlet works are required to pass the inflow design flood (IDF) (for high hazard potential dams, a probable maximum flood [PMF] is required), but are not designed for this flow condition. Documentation suggests the designer used “risk concepts” in selecting a design discharge less than required by guidance, but really only examined the probability of the loading event and not the probability or consequence of failure. Using all of the risk information may have led to entirely different risk-informed decision if the downstream area were highly populated.

Risk information could also be used to help with guiding the design of a new dam. For example, the outlet works might be designed to assist in passing a flood that is less than the IDF (refer to the dam hazard potential classification for the appropriate design) at a high hazard potential structure since the remote risks (events are

infrequent, and the dam is in a remote area) involved do not justify the added cost for designing to the full IDF. The same dams with high downstream consequences may need to exceed existing risk reduction guidance to achieve acceptable risk levels.

The designer should consider several factors involving risk-informed decision making with energy dissipators. The following is an example set of questions to consider (not an exhaustive list and may need to be expanded for site-specific conditions):

- What is the hazard classification of the dam?
- What is the generally accepted guidance for the design event?
- If designing for a lesser flood event (compared to an IDF or PMF), when would the design potentially experience difficulty? The full range of flows should be considered.
- Is the outlet works required to be in used to safely pass the inflow design event?
- Will failure of the energy dissipator lead to dam failure? Consider stability of the earthen and concrete dams, backward erosion, potential for increased seepage, etc.
- How high are the consequences downstream if a dam failure would occur? A higher design standard may be needed for dams just above densely populated areas.
- Can the flow be shut down if a problem occurs? Does the outlet have a single gate or redundant emergency gates to shut down flow? Redundant gates may be prudent if downstream consequences are high (densely populated).
- Will the repairs be extensive or simple to implement following the flood? How long will the repairs take?
- A greater factor of safety is required for structures that operate frequently or continuously or have significant or high consequences downstream. Some failure modes, like damage from cavitation, are a cumulative process that can continue in successive flood events.



## Chapter 2

# Hydraulic Jump Stilling Basins

The purpose of energy dissipation is to protect the downstream riverbed and banks from erosion and to ensure that the high velocity, turbulent flow from the outlet works does not undermine the dam and adjoining structures. The discharge from an outlet works, whether it is through a control valve or gate or a free flow conduit, emerges at a high velocity, usually in a nearly horizontal direction. The hydraulic jump stilling basin is most often used for energy dissipation of outlet works discharges with anywhere from 10 to 85 percent energy dissipation depending on the Froude number of the incoming flow. The hydraulic jump stilling basin can have less than 50 percent energy dissipation for low Froude numbers.

Experience with hydraulic jump stilling basins has shown that considerable damage can occur to concrete surfaces from debris present in the hydraulic jump. This debris often enters the basin from materials suspended in the flow, from soil or rock coming down the adjoining side slopes, by people throwing materials into the basin, or by reverse currents in the jump drawing debris in. The resulting damage consists of erosion of the floor, walls, and appurtenances. [Chapter 12](#) provides further information on the maintenance and repair of stilling basins.

### 2.1 Hydraulic Jump

The hydraulic jump can be used to dissipate energy in water flowing from an outlet works conduit and prevent scouring downstream. An unconstrained (i.e., no obstacles in the flow stream) hydraulic jump effectively dissipates energy, but the typical length of a free jump can be less than efficient from an economical perspective, as the entire jump must be constrained within a concrete structure. Flow occurring upstream of the jump may have high erosive potential, and a concrete structure limits this potential. The hydraulic jump stilling basin is a structure used to position, create, and contain a hydraulic jump for a variety of flow conditions. The stilling basin forces the water flowing at a higher than critical velocity into a hydraulic jump where energy is dissipated in the resulting turbulence and internal friction. A hydraulic jump occurs when supercritical flow on a steep slope encounters a mild slope and is forced to transition through critical flow to subcritical flow. The hydraulic jump stilling basin is typically located on horizontal or gradually sloping surfaces at the bottom of a steep slope to create the hydraulic

jump itself. The stilling basin floor elevation is selected to provide jump depths that most nearly agree with the conjugate and tailwater depths for various discharges. Appurtenances such as chute blocks, baffle blocks, and end sills (dentated or solid) may be used to improve the efficiency of the hydraulic jump and reduce the required length of the stilling basin. However, cavitation can damage appurtenances in high velocity basins. Cavitation occurs when partial vacuums form in fast flowing water caused by subatmospheric pressures immediately downstream from an obstruction or offset such as block. The implosion (collapse) of this void or bubble drives water into the block with a terrific force that can cause pitting and wearing away of the concrete surface. Cavitation is often accompanied by loud noise and vibration that sounds like someone is pounding the block with a hammer.

Reclamation, the USACE, and the Saint Anthony Falls (SAF) Hydraulic Laboratory have developed several standardized, rectangular, hydraulic jump stilling basin designs on horizontal surfaces. However, different design philosophies were used in the development of the dimensions and appurtenances for these basins. For example, the baffle blocks on Reclamation basins are higher and located further upstream in the basin than in USACE design. Despite these differences, the basins have generally performed satisfactorily.

### 2.2 The Froude Number and the Hydraulic Jump

The hydraulic jump has distinctive characteristics and assumes a definite form depending on the relation between the energy and the depth of the flow. The jump form and the flow characteristics can be related to the kinetic flow factor ( $v_1^2/gd_1$ ) of the flow entering the basin; to the critical depth of flow entering the basin ( $d_1$ ); or to the Froude number (eq. 1).

$$F_1 = v_1/(gd_1)^{1/2} \quad \text{eq. 1}$$

where,

$F_1$  = Froude number of the incoming flow

$v_1$  = velocity of flow entering the basin upstream of the jump (ft/s)

$g$  = acceleration due to gravity (32.2 ft/s<sup>2</sup>)

$d_1$  = depth of flow entering the basin upstream of the jump (ft)

The kinetic flow factor is equal to the Froude number squared. If the Froude number is equal to one, the flow is said to be critical. If the Froude number is less than one, the flow is subcritical, and if the Froude number is greater than one, the flow is supercritical.

Based on a series of model studies by Reclamation, different types of hydraulic jumps on horizontal or gradually sloping surfaces can be classified according to the Froude number of the incoming flow. The ranges of Froude number given in

table 2 for the various types of jump are not clear-cut, but overlap to a certain extent depending on local conditions.

Table 2.—Hydraulic jump classified by Froude number

Froude number ( $F_1$ )	Description
$F_1 < 1.0$	For Froude numbers less than 1.0, the flow is already subcritical.
$F_1 = 1.0$	For Froude numbers equal to 1.0, the flow is at critical depth, and a hydraulic jump cannot form.
$1.0 < F_1 < 1.7$	For Froude numbers between 1.0 and about 1.7, the flow is only slightly below critical depth (supercritical flow). As the Froude number approaches 1.7, a series of small rollers or undulations begin to develop on the water surface, which becomes more intense as the Froude number increases up to about 2.5. This hydraulic jump is referred to as an undular jump.
$1.7 < F_1 < 2.5$	For Froude numbers between 1.7 and 2.5, the series of small rollers developing on the surface of the jump intensifies, but the downstream water surface remains smooth. The velocity throughout is fairly uniform, and the energy loss is low (10 to 15 percent energy loss). This is referred to as a weak jump or a prejump stage. Refer to <a href="#">figure 16A</a> for an illustration of this hydraulic jump.
$2.5 < F_1 < 4.5$	For Froude numbers between 2.5 and 4.5, an oscillating form of jump occurs with the jet entering the jump from the stilling basin floor up to the water surface and back again with no regular period. Each oscillation produces a large, objectionable wave of irregular period that can carry far beyond the end of the basin. This jump is referred to as an oscillating jump or as being in the transition stage because a true hydraulic jump has not fully developed, and troublesome pulsating jump action can occur. Transition jumps occur often in low head structures. Energy loss ranges from 25 to 50 percent. Refer to <a href="#">figure 16B</a> for an illustration of this hydraulic jump.
$4.5 < F_1 < 9.0$	For Froude numbers between 4.5 and 9.0, a stable and well balanced jump occurs. Turbulence is confined to the main body of the jump, and the water surface downstream is comparatively smooth. The action and position of this jump are least sensitive to variation in tailwater depth. Energy dissipation ranges from 45 to 70 percent energy loss. This jump is referred to as a steady jump, a good jump, or a well balanced jump. Refer to <a href="#">figure 16C</a> for an illustration of this hydraulic jump.
$F_1 > 9.0$	For Froude numbers greater than 9.0, the turbulence within the jump and the surface roller becomes increasingly active, resulting in a rough downstream water surface. The jump action is rough, with a considerable amount of spray, but effective, with energy dissipation up to 85 percent. This jump is sensitive to tailwater depth. This jump is referred to as a strong jump, a rough jump, or a choppy jump. Refer to <a href="#">figure 16D</a> for an illustration of this hydraulic jump.
$F_1 > 10.0$	For Froude numbers greater than 10.0, a very deep basin with high training walls is required. A rough water surface exists with strong surface waves downstream from the jump ( <a href="#">figure 17</a> ). For high head structures, a bucket-type energy dissipator should be considered. A roller bucket requires a steep entrance and adequate tailwater to keep it from acting as a flip bucket.

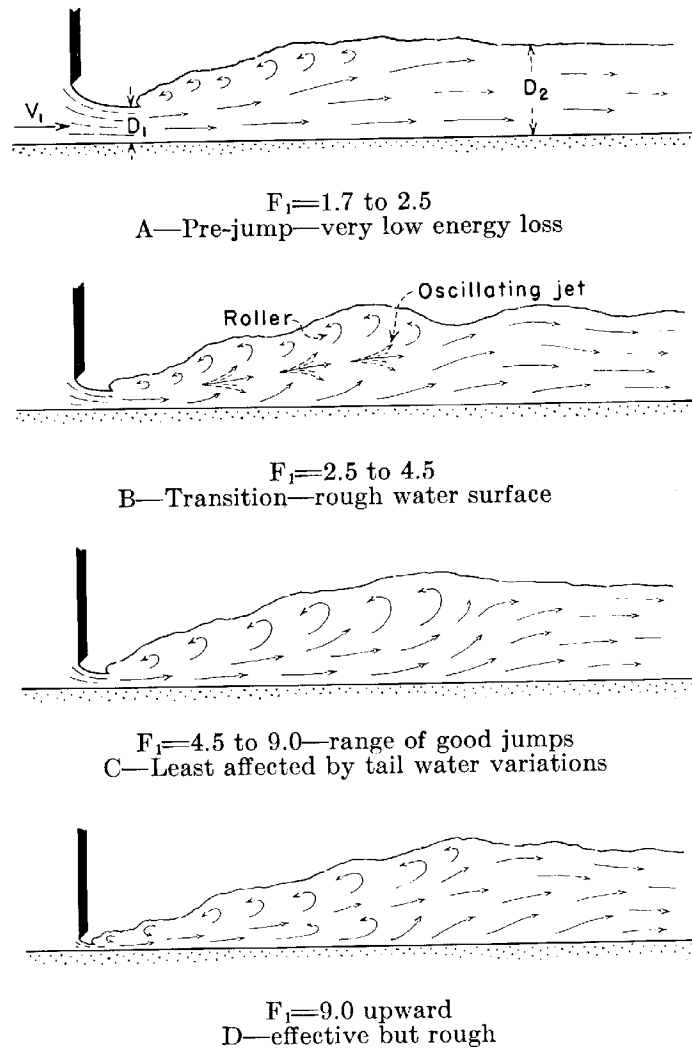

Figure 16.—Hydraulic jump formations on a horizontal surface (Reclamation, 1984, p. 16).

The illustrations shown in figure 16 bring up a few design considerations (Reclamation, 1984, p. 17):

- The hydraulic jump in figure 16A requires no special appurtenances in the basin. The only requirement is to provide the proper length, which is relatively short.
- The hydraulic jump in figure 16B presents wave problems that are difficult to overcome. Appurtenances in the basin are of little value.
- The hydraulic jump in figure 16C experiences no particular difficulties. Appurtenances are valuable as a means of shortening the length of the basin.



Figure 17.—The Froude number for the discharge in this model study is greater than 10.0. Note the rough water surface with strong waves downstream from the jump.

- The hydraulic jump in [figure 16D](#) experiences intermittent slugs of water rolling down the front face of the jump that fall into the high velocity jet. The high velocity jet no longer carries for the full length of the jump.

Rectangular stilling basins are preferred over trapezoidal basins. Model tests have shown that the hydraulic jump action in a trapezoidal basin is much less complete and less stable than in a rectangular basin. In a trapezoidal basin, the water in the triangular areas along the sides of the basin adjacent to the jump does not oppose the incoming high velocity jet. The jump, which tends to occur vertically, cannot spread sufficiently to occupy the side areas. Consequently, the jump forms only in the central portion of the basin while areas along the outside will be occupied by upstream-moving flows that ravel off the jump or come from the lower end of the basin. The eddy or horizontal roller action resulting from this phenomenon tends to interfere with the jump action to the extent that there is incomplete dissipation of the energy and severe scouring can occur beyond the basin. For good hydraulic performance, the sidewalls of a stilling basin should be vertical, or as close to vertical as practicable. Where trapezoidal basins are contemplated, a model study is strongly recommended.



### 2.3 Initial Depth, Sequent Depth, Conjugate Depth, and Tailwater Depth

The depth of the incoming flow entering the stilling basin before (upstream of) the hydraulic jump is called the initial depth ( $y_1$ ,  $d_1$ , or  $D_1$ ). The depth of the flow after the hydraulic jump is called the sequent or conjugate depth or conjugate tailwater depth ( $y_2$ ,  $d_2$ , or  $D_2$ ). The conjugate depth depends on the specific energy available at the entrance of the basin (Froude number) and the initial depth of flow.

The expression for the hydraulic jump based on the impulse-momentum principle may be written:

$$y_2 = -y_1/2 + (y_1^2/4 + 2v_1^2y_1^2/gv_1)^{1/2} \quad \text{eq. 2}$$

where,

- $y_1, y_2$  = depths of flow before and after the jump (ft)
- $v_1$  = velocity of the flow entering the basin upstream of the jump (ft/s)
- $g$  = acceleration due to gravity (32.2 ft/s<sup>2</sup>)

Figure 18 illustrates the relationship between these variables in a hydraulic jump for a rectangular channel.

The Froude number of the incoming flow has been previously defined in equation 1. Rewriting equation 2 and substituting in the Froude number produces the following equation, which relates the ratio of the conjugate depth and initial depth as a function of the Froude number of the incoming flow:

$$y_2/y_1 = 1/2(((1+8F_1^2)^{1/2})-1) \quad \text{eq. 3}$$

where,

- $y_1, y_2$  = depths of flow before and after jump (ft)
- $F_1$  = Froude number of the incoming flow

This equation is known as the hydraulic jump formula and is used to compute the conjugate depth. A hydraulic jump will form if the Froude number, the initial depth, and the conjugate depth satisfy the hydraulic jump formula. For Froude numbers equal to 1, the ratio of the depths is also equal to 1.

The hydraulic jump formula (eq. 3) is shown as a solid line on figure 19 and represents the conjugate tailwater depth. The dashed lines are guides drawn for tailwater depths other than conjugate depth. The stilling basin should be designed for the conjugate tailwater depth. The dashed lines for minimum tailwater depth indicate the point at which the front of the jump moves away from the chute blocks. In other words, any additional lowering of the tailwater would cause the jump to leave the basin. The heavy dashed line, labeled “Minimum T.W. Depth, Basin II,” has been used as the lower design limit for many structures. The limits for stilling

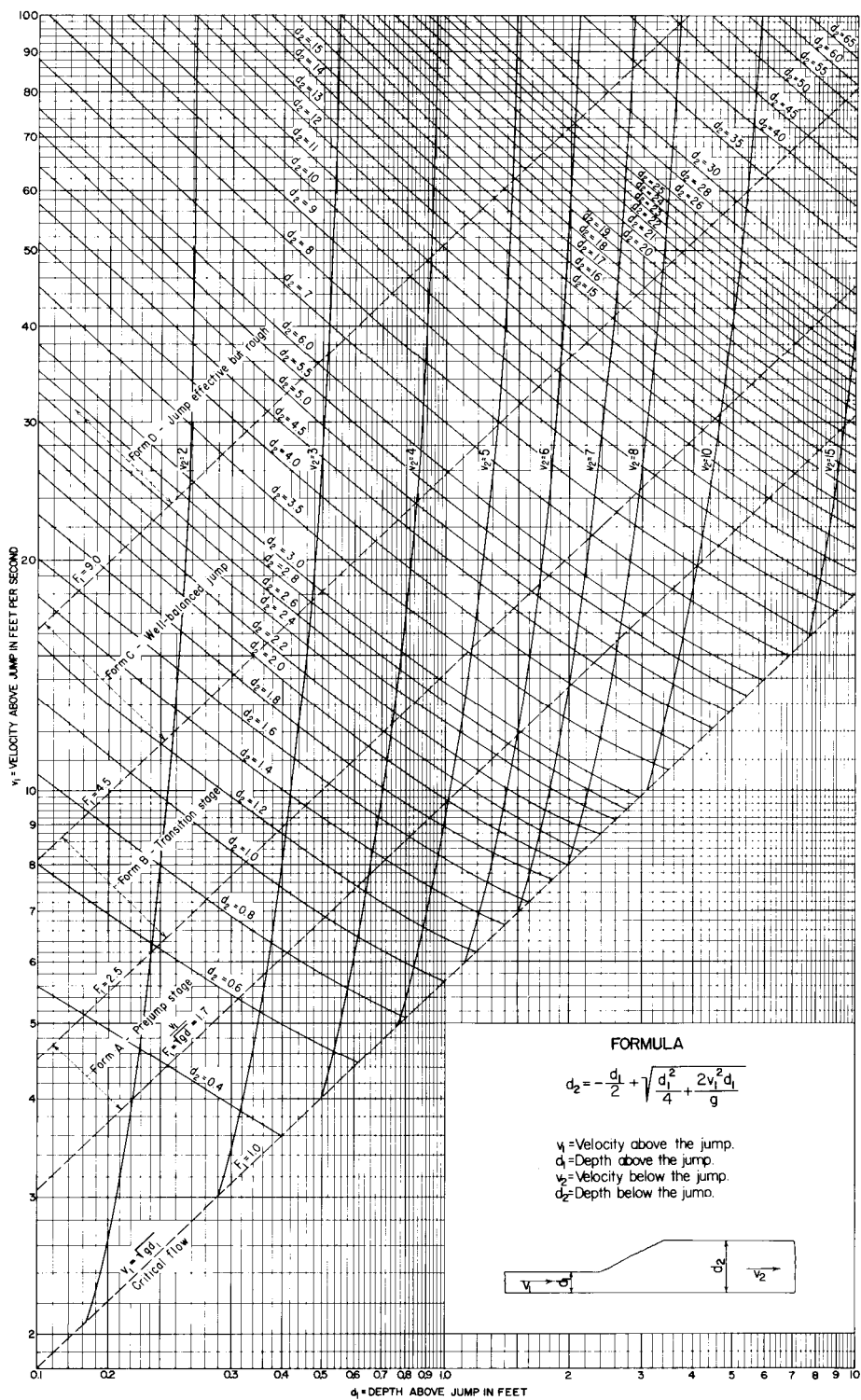

Figure 18.—Relationship between variables in a hydraulic jump (Reclamation, 1987, p. 389). See Reclamation (1987) for information concerning the variables as denoted in this figure.

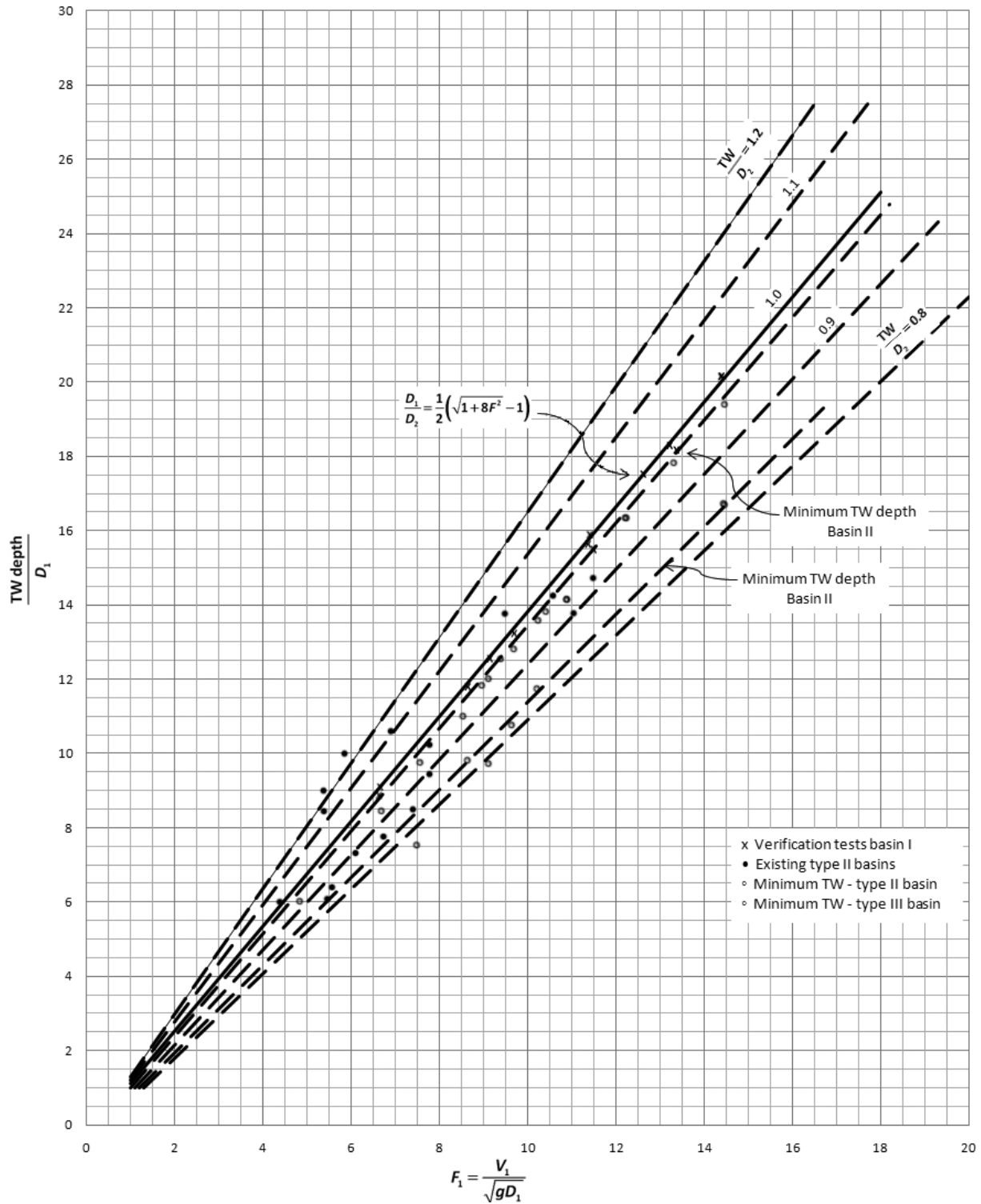

Figure 19.—Minimum tailwater depths (Reclamation, 1984, p. 25). For a discussion of Reclamation basin types, see section 2.7.1. See Reclamation (1984) for information related to the variables as denoted in this figure.

basin design should stay between the minimum T.W. Depth, Basin II and the solid line based on the hydraulic jump formula (eq. 3).

The ability of the hydraulic jump to remain in the basin for a slight lowering of tailwater depth becomes more difficult for higher and lower values of the Froude number. The jump is least sensitive to variation in tailwater depth in the middle range, or values of  $F_1$  from 4.5 to 9. As the Froude number increases, the jump becomes more sensitive to tailwater depth. For Froude numbers as low as 8.0, a tailwater depth greater than the conjugate depth is advisable to be certain that the jump will stay within the basin.

Most hydraulic jump stilling basins are designed so that the given tailwater holds the toe of the jump at the upstream end of the basin. Lowering the tailwater reduces the backpressure force holding the jump in equilibrium and causes the jump to move downstream in the basin. If the tailwater is too low, the jump will sweep out, or wash out of the basin. A sweep-out is a dangerous condition since the high velocity flow reaches the end sill causing a high velocity jet trajectory “rooster tail” and plunge pool type erosion downstream from the structure.

A tailwater rating curve gives the stage-discharge relationship of the downstream natural channel. For the hydraulic jump stilling basin, downstream water levels for various discharges must conform to the tailwater rating curve. The basin floor level must therefore be selected to provide jump depths (conjugate) that most nearly agree with the tailwater depths. For a given basin design, the tailwater depth for each discharge seldom corresponds to the conjugate depth needed to form a perfect jump. Thus, the relative shapes and relationships of the tailwater curve to the depth curve determine the required minimum depth to the basin floor. The basin must be deep enough to provide for full conjugate depth plus additional depth as a safety factor at the maximum design discharge. For lesser discharges, the tailwater depth is greater than the required conjugate depth, thus providing an excess of tailwater, which is conducive to the formation of a “drowned jump.” With the drowned jump condition, instead of achieving good jump-type dissipation by the intermingling of the upstream and downstream flows, the incoming jet plunges to the bottom and carries along the entire length of the basin floor at high velocity. A wider basin would provide a shallower basin, which would allow the ideal jump depth to more closely match the tailwater depths for all discharges. The importance of accurate tailwater (for the full range of stilling basin operations) cannot be overemphasized for hydraulic jump stilling basins.

## 2.4 Length of the Hydraulic Jump Stilling Basin

For any hydraulic jump stilling basin, the optimal length varies for each outlet works discharge. So, the selected length should be designed for when the basin is operated at maximum design flow.

The length of the hydraulic jump is measured from the toe of the jump to the point where the water surface profile becomes horizontal. For a stilling basin with a horizontal floor, the toe of the jump is assumed to occur at the intersection of the chute and the horizontal stilling basin floor. The end of the hydraulic jump is more difficult to define and could be chosen as either the point downstream where the high velocity jet begins to lift from the floor, or a point immediately downstream from the roller where the water surface becomes horizontal, whichever occurs farthest downstream. The length of the basin is measured from the intersection of the chute and the horizontal stilling basin floor to a point downstream that will confine the entire length of the jump to the concrete floor and side walls of a conventional stilling basin. Increasing the length of the basin will not compensate for a lack of tailwater depth. The length of the jump has been related to the Froude number of the incoming flow. Figure 20 shows the recommended basin lengths for Reclamation type I, II, and III basins based on the Froude number ( $F_1$ ) of the incoming flow and the conjugate depth ( $D_2$ ). For a discussion of Reclamation basin types, see section 2.7.1.

### 2.5 Stilling Basin Appurtenances

Hydraulic jump stilling basins are usually equipped with appurtenances that include chute blocks, impact baffle piers or blocks, and solid or dentated end sills (figures 33,

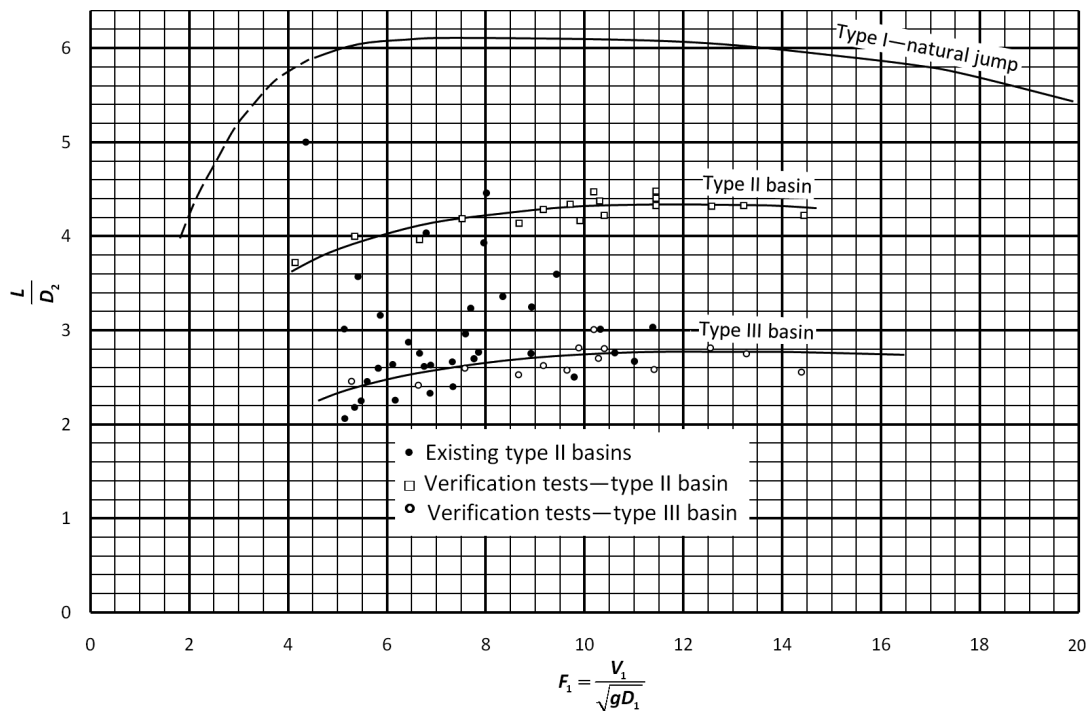

Figure 20.—Length of hydraulic jump for type I, II, and III basins (Reclamation, 1984, p. 27). See Reclamation (1984) for information related to the variables as denoted in this figure.

35, and 36). The purpose of these appurtenances is to increase turbulence and produce a stabilizing effect on the jump, which reduces the required length of the stilling basin and provides a factor of safety against sweepout caused by inadequate tailwater depth. Chute blocks, baffles blocks, and an end sills increase the efficiency of the jump and decrease the required length of the stilling basin to dissipate the energy in the high velocity flow. All appurtenances should be self-cleaning and nonclogging. The effectiveness of the appurtenances increase as the Froude number of the incoming flow increases. However, at high Froude numbers, chute blocks, baffle blocks, and end sills have been damaged by cavitation.

### 2.5.1 Chute blocks

Chute blocks, located at the upstream entrance to the stilling basin (figure 21), serve to increase the effective depth of the incoming flow, break the flow up into a number of small jets, and help create the turbulence required for effective energy dissipation. Their function is to separate the incoming jet and lift a portion of it from the floor, which creates energy-dissipating turbulences, producing a shorter length of jump than would be possible without them. These blocks also tend to stabilize the jump and thus improve its performance. Chute blocks also reduce the tendency of the jump to sweep off the apron at tailwater elevations below conjugate depths. Model tests of a solid chute block across the entire width of the basin showed that less energy was dissipated than if separate blocks were used. The stilling basin performs the same whether a chute block or a space is next to the sidewall as long as the blocks are symmetrical about the centerline of the outlet. Staggering of the chute blocks with the downstream end sill dentates is not necessary. The chute blocks should be staggered with the downstream baffle blocks.



Figure 21.—Looking upstream at a chute block located at the upstream entrance of a stilling basin. A structural underdrain exits from the downstream face of the chute block.



### 2.5.2 Baffle blocks

Baffle blocks (also referred to as baffle piers and floor blocks) are placed in intermediate positions across the basin floor (figure 22) to stabilize the jump formation, dissipate energy by impact action, and increase turbulence to assist in energy dissipation. Baffle blocks may be subjected to cavitation damage during certain flow velocities and pressures. To minimize damage from cavitation, the designer should consider the cavitation index as discussed section 2.7. Streamlining baffle blocks has been found to be somewhat counterproductive. The less turbulence created by the baffle blocks, the less effective they are in dissipating energy and the longer the basin requirement becomes. Increasing the submergence of the baffle blocks by raising tailwater depths reduces tendencies towards cavitation, but the baffles affect a smaller proportion of the flow and lose much of their effectiveness (Mason, 1982, p. 214).

The distance between the chute blocks and baffle blocks, as well as the baffle blocks and end sill, is important for improved efficiency. Placing the baffle blocks too far upstream leaves them susceptible to cavitation and can cause waves downstream.

Placing the baffle blocks too far downstream makes them ineffective for reducing jump lengths and can cause local bottom velocity disturbances. Baffle blocks should not be located against the side walls in order to prevent a high boil that might overtop the side wall. The baffle blocks are located downstream from the openings in the chute blocks to break up the jets issuing from between the chute blocks and passing along the stilling basin floor. Baffle blocks shorten the length of the hydraulic jump by causing the bottom jet beneath the surface roller to be deflected upward. The baffle blocks also serve to hold the hydraulic jump in equilibrium within the basin.



Figure 22.—Baffle blocks in a hydraulic jump stilling basin (flow is from left to right).

### 2.5.3 End sill

The end sill, either dentated (figure 23) or solid, is usually located at the downstream end of the stilling basin. A dentated end sill resembles a row of baffle blocks. The purposes of the end sill are to reduce the length of the stilling basin by creating additional tailwater depth and to provide for scour control. The end sill also deflects the flow along the stilling basin floor upward and away from the bed of the downstream channel, thus protecting it from scour. The end sill also serves to hold the hydraulic jump in equilibrium within the basin resulting in improved efficiency. For large basins that are designed for high incoming velocities, the end sill is usually dentated to perform the additional function of diffusing the residual portion of the high velocity jet that may reach the end of the basin.

### 2.6 Other Stilling Basin Features

Hydraulic jump stilling basins contain other features, such as side walls or training walls, which contain the hydraulic jump. Splitter walls assist in keeping the flow uniform. Wing walls and cutoff walls at the downstream end of the basin provide erosion protection. Stoplog slots at the downstream end allow for unwatering of the basin. Structural underdrains beneath the basin floor relieve uplift pressures. Flow deflectors help to prevent abrasive material from being drawn into the basin.



Figure 23.—A dentated end sill for a combined outlet works and spillway stilling basin.



### 2.6.1 Side walls and training walls

The side walls of the stilling basin, also referred to as training walls, run parallel to the flow and contain the hydraulic jump. The height of the training wall is usually set so that the maximum tailwater for the design discharge is contained in the stilling basin with sufficient freeboard. This prevents the walls from being overtopped by surges, splash, spray, and wave action set up by the turbulence of the jump. An adequate factor of safety should be considered in evaluating the tailwater depth (especially if the stilling basin will commonly experience large flow). Often, tailwater curves are extrapolated for discharges encountered in design, so they can be in error. If the total discharge into the basin changes, there will be a time delay before a change is reflected in the tailwater depth. In some cases, the most adverse condition may occur at less-than-design discharge. The designer needs to consider all possible factors that may affect the tailwater depth.

The surface roughness of the flow is related to the energy dissipated in the jump and to the depth of flow in the basin. The following empirical expression (Reclamation, 1987, p. 398) provides values that have proved satisfactory for most basins when designing the height of the side wall:

$$\text{Freeboard in feet} = 0.1(v_1 + d_2) \quad \text{eq. 4}$$

where,

$$\begin{aligned} v_1 &= \text{velocity of flow entering the basin upstream of the jump (ft/s)} \\ d_2 &= \text{conjugate depth (ft)} \end{aligned}$$

Backfill material placed behind the stilling basin walls should be a pervious, free draining, granular material to ensure the lowest level of saturation and to minimize horizontal earth pressures. This is especially important in cold climates (i.e., in locations where the ground can freeze). Wall surfaces in contact with frost-susceptible backfill and with access to water are subject to frost penetration, ice lensing, and subsequent frost heave that can be significant. Placement of the free draining material adjacent to the wall limits or prevents frost heave. A system of drainpipes is often provided along the outside perimeter of the basin walls to facilitate the drainage.

Reclamation typically uses a cantilever design for walls shorter than 40 feet and considers counterforted (figure 24) design for higher walls. The counterforts are concrete stub walls that extend into the soil to which the wall panels are attached. Frictional resistance between the soil and counterforts helps keep the wall in place. A counterforted wall is more complicated to analyze than a cantilever wall. A counterforted wall can fail through a number of mechanisms including moment or shear failure in the counterforts, moment or shear failure in the wall panels between counterforts, and failure of connecting steel between the wall panels and the counterforts.



Figure 24.—Type II stilling basin with counterforted walls. The basin has been unwatered for repairs.

### 2.6.2 Splitter walls

For a stilling basin with two or more conduits discharging into it, splitter walls separating and isolating the flow from the conduits are typically required (figure 25). A splitter wall assists in keeping the flow uniform and prevents returning eddies from developing when the conduits are operated separately. The wall provides a separate basin or bay for each conduit to discharge into. This can be especially useful if repairs are needed to valves or gates on one conduit, but flows need to be maintained through the other conduit(s). Closure of one basin or bay requires construction of a downstream berm or installation of stoplogs to facilitate unwatering.

Splitter walls are susceptible to vibration when the frequency of the surges in the hydraulic jump coincides with the natural frequency of the wall. Falvey (1979) summarized Reclamation's experience with the failure of a stilling wall at Navajo Dam. The wall was supported at one end and the base. Reclamation (1967) studied the basin in detail using physical model tests after fatigue cracks were discovered at the base of the wall. One proposed solution was to support the top of the wall with a beam that spanned the basin. The final solution was to remove the wall and the wedges downstream of the hollow-jet valves. This example shows that if splitter walls are used, they must be designed to resist large lateral loads that have frequencies in the range of 2 to 5 Hz.



Figure 25.—Splitter wall separating discharge from two conduits.

### 2.6.3 Wing walls

Wing walls have proven to be problematic at some Reclamation stilling basins, particularly in cold climates where frost heave is a consideration. Special attention concerning drainage and installation is required. Wing walls can also be undermined by the turbulent flow exiting the stilling basin. In addition, the recirculated flows at the end of the basin may be slightly stronger since the flow would not be able to spread out as much as it would without the wing walls in place. Often, as an alternative to wing walls, the side slopes of the exit channel are wrapped around the end of the stilling basin. The side slopes should be protected from erosion using bedding and riprap.

Where wing walls have been used, they are typically located at the downstream end of the basin on either side and are most often orientated normal to the side walls. Some designers feel wing walls calm water outside of the side walls by preventing eddies from extending as far upstream as they otherwise would. The use, shape, and size of the wing walls depends on local conditions such as width of the channel downstream, and degree of protection needed. An example of a basin with a wing wall configuration is shown in [figure 26](#).

### 2.6.4 Cutoff walls

A cutoff wall is used at the end of the stilling basin to prevent scour from undermining the basin. The depth of the cutoff wall should be greater than the expected depth of erosion at the end of the basin.



Figure 26.—Wingwalls oriented normal to the basin side walls.

### 2.6.5 Stoplog slots

Designers should consider including stoplog slots at the downstream end of stilling basins to allow for unwatering of the basin due to frequent operation, resulting in the need for inspection, maintenance, or repair (figure 27). Refer to section 11.6.7 for additional discussion pertaining to unwatering of the basin. For two-bay stilling basins, stoplogs can isolate one bay while allowing operation of the other bay.

### 2.6.6 Structure underdrains

Structure underdrains are typically installed to assist in preventing flotation (uplift) of the stilling basin during unwatering of the stilling basin or during operations should the hydraulic jump move downstream. The basin should not be unwatered if underdrains are not present unless adequate investigation indicates flotation is not an issue. Underdrains are typically laid out in an interconnected grid (longitudinal and transverse) to collect seepage at the interface between foundation rock or soil and the concrete basin structure. The underdrains are constructed such that, during certain operating conditions, discharge from the outlet works flows past the underdrain outlets (usually located on the downstream side of the chute blocks). The low pressures created result in draining flow from beneath the basin structure and lowering uplift pressures. Vents are usually installed in the walls to ensure negative pressures do not develop.

The underdrain system, if damaged, can very easily cause particle transport from the foundation, which has been observed at a number of dams. Since the operations of the outlet works are intermittent, removal of soil would be intermittent and could occur over a long period of time. The typical winter seepage regime could have primed the system with water and soil particles and the underdrains could nearly



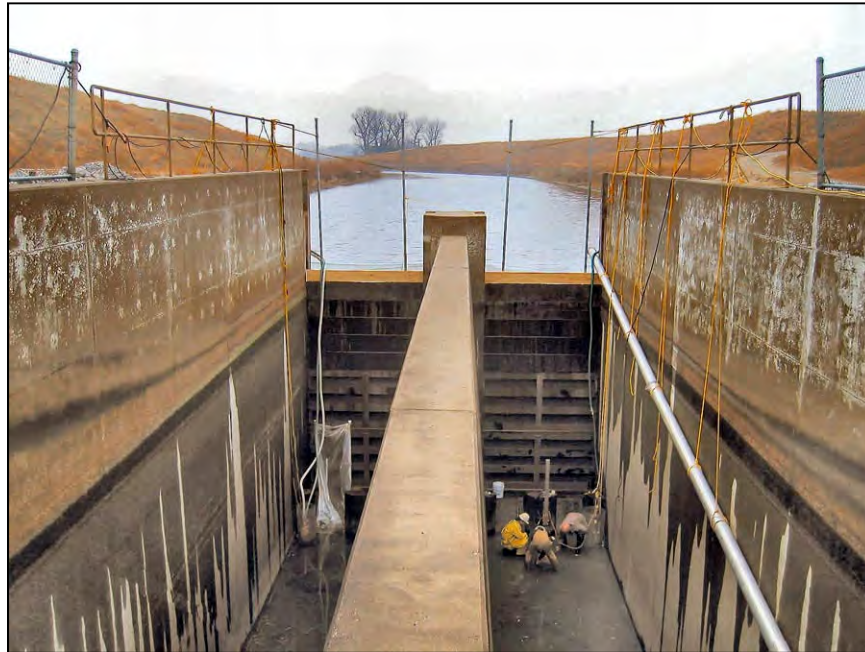

Figure 27.—Stoplogs have been installed in slots to allow for repairs to be made to the unwatered stilling basin.

instantaneously remove the water and some soil from beneath the structure each year under certain operating conditions. Hydraulic connection of the stilling basin to the groundwater can potentially cause very severe transient seepage conditions and particle transport. A number of underdrain systems associated with outlet works chutes and stilling basins have contributed to internal erosion of drainage and foundation materials (see the [Virginia Smith case history in the appendix](#)). The initiating condition appears to be fluctuating low pressure near the underdrain created during operation (i.e., discharge passing over underdrain exit points that are typically in chute blocks) and/or localized drainage pipe failure. The drain system becomes an unfiltered seepage exit subjected to fluctuating high gradients. Once the internal erosion conditions start, they can propagate upstream toward the dam, which could ultimately lead to an internal erosion failure of the dam and uncontrolled release of the reservoir. Additionally, loss of foundation support can lead to structural failure of the chute or stilling basin structures on soil foundations during operation that can progress upstream toward the dam.

Many Reclamation chute and stilling basin structures terminate the drainage provisions at the downstream face of the chute blocks (usually at the interface between the chute and stilling basin floor). For maximum design releases, subatmospheric pressures generally result at this location (i.e., the beginning of the hydraulic jump), which lowers hydrostatic pressures beneath the chute and basin floors. However, for smaller releases, the tailwater could exceed the conjugate depth needed for the jump, which causes the beginning of the hydraulic jump to move

upstream of the termination point for the drainage provisions. This could lead to the introduction of increased hydrostatic (uplift) pressure beneath the chute and/or basin floors, which, in turn, could result in damage or failure. Although Reclamation has not experienced this type of failure, such a failure occurred at Karnafuli Spillway in Bangladesh. Perhaps one factor that has helped Reclamation avoid this type of failure is that the majority of Reclamation hydraulic structures, particularly spillways and outlet works, have been constructed on firm foundations with anchorage (i.e., rock bolts or anchor bars). The bond strengths between the concrete and foundation and anchorage are not usually considered as stabilizing features, but as redundancies that are considered prudent, given the potential consequences resulting from damage or failure of a hydraulic structure (Reclamation, 2004, p. 55).

Prior to about the 1980s, most underdrain designs utilized clay tile or concrete pipe. Newer designs have used slotted polyvinyl chloride (PVC) and perforated profile wall high density polyethylene (HDPE) pipe encased in a sand/gravel envelope (figure 28). Geotextiles should not be used as an envelope material for underdrains since they are prone to plugging. All new designs and any subsequent basin modifications should be sized to accommodate inspection using closed circuit television (CCTV) equipment. The following design guidance should be considered for underdrain systems:

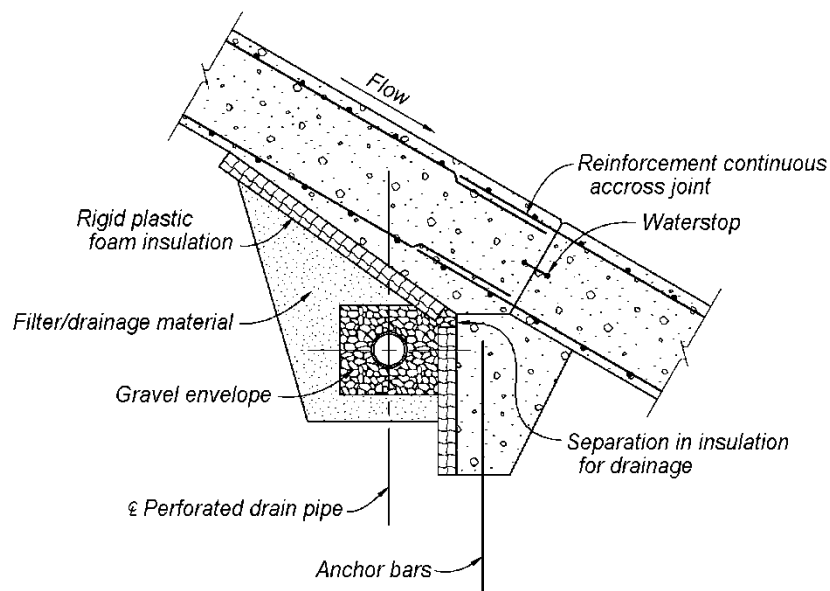

Figure 28.—Filtered underdrain to prevent movement of foundation materials into drainage system and the initiation of foundation erosion.

- *Pipe diameter.*—The minimum recommended pipe diameter to successfully accommodate CCTV equipment is 8 inches. Although camera-crawlers are available for pipes smaller than 8 inches, they are very limited in cable-tether-pulling capacity and generally do not have sufficient traction for use in drain inspection. In addition, these cameras typically only have a d lens, and the transport vehicle is not steerable. Generally, camera-crawlers used in pipes with diameters between 8 and 12 inches have cameras with some pan, tilt, and zoom capabilities, but generally are not steerable. Camera-crawlers used in pipes with diameters of 15 inches or larger are steerable, have a greater cable-tether-pulling capacity, and have cameras that can provide a wider array of optical capabilities including pan, tilt, and zoom. Where practical, the use of pipes with diameters 15 inches or larger is recommended to facilitate CCTV inspection. Larger diameters allow for the use of more powerful and versatile camera-crawlers. The selection of larger pipe diameters also allows for the accommodation of sediment accumulation on the pipe invert. Experience has shown that sediment accumulation is the most common plugging mechanism in drainpipes. Larger pipe diameters increase the likelihood of the camera-crawler getting past many types of obstructions that may exist in the pipe.
- *Pipe bends.*—The maximum recommended horizontal bend angle to successfully accommodate CCTV equipment is 22.5 degrees. In pipes with diameters of 8 and 10 inches, some camera-crawlers encounter difficulties navigating bends of 45 degrees or greater since the camera cannot clear the pipe crown as it travels through the bend and drag friction on the tether cable reduces pulling capacity. Sweeping bends should always be used to facilitate camera-crawler navigation. For best practice in pipes of all diameters, a series of 22.5-degree bends is recommended. Each 22.5-degree bend should be connected to a minimum 5-foot length of straight pipe to allow the camera-crawler to easily navigate around the sweeping bend and provide adequate crown clearance in the pipe. Many older existing drain systems used sharp 90-degree bends, making inspection practically impossible. In a few cases, subsequent modifications have allowed for installation of access at these locations to facilitate inspection.
- *Pipe length.*—The length of pipes used beneath a basin is generally not a concern since outlet works energy dissipators are not excessively long or wide. Camera-crawlers can easily accommodate distances up to 1,000 feet.
- *Cleanouts.*—Cleanouts should be provided to facilitate cleaning and access into the underdrain system. Cleanouts should also utilize a sweeping bend configuration and 22.5-degree bend segments.

Older underdrain systems typically have limited access and often experience cleaning difficulties due to the existing pipe configurations. A high percentage of underdrain systems experience some degree of clogging or plugging during their operational life.

The mechanisms causing clogging and plugging often include calcium carbonate, biological fouling, organic growth, deposition of fines and sands, and failure of the pipe material. The reduced effectiveness of an underdrain system can allow pressures to increase to the point where the stability of the structure is reduced, or cause seepage to move to unprotected areas where internal erosion may develop undetected. The most important factor in the successful long-term performance of an underdrain system is a well developed and cut program of inspection, repair, and cleaning. For additional guidance on CCTV equipment and accommodation, see [section 11.6.4](#) and [Cooper \(2005\)](#). Refer to the [Twin Lakes Dam case history](#) in the appendix for an example of CCTV inspection of a basin underdrain system.

Experiences with installing typical underdrain systems in rock foundations have resulted in considerable excavation (removal) of competent rock, which is replaced with drainage material (sand and gravel). Jointing in rock and excavation techniques have often resulted in significant overbreak of the designed drain trenches and removal of considerable amounts of foundation material. To minimize this situation, an alternative drain installation should be considered as shown in [figure 29](#).

Designers should recognize that even modern dams designed according to accepted practices can be subject to internal erosion (particularly when erodible soils are present). For guidance on the proper design, monitoring, and maintenance of a structural underdrain system, see [Reclamation's \*Drainage for Dams and Associated Structures\* \(2004\)](#). For additional guidance on plastic pipe used in structural underdrain systems, see [FEMA's \*Plastic Pipe Used in Embankment Dams\* \(2007\)](#).

Important factors to consider in the design and construction of structure underdrains include:

- Drainpipe can be damaged during construction, can crack due to settlement, and can potentially be damaged by freezing.
- Embankment or foundation materials can be eroded into the underdrains over long periods of time before being detected. This can lead to a loss of support for the stilling basin, the formation of an unfiltered exit, and the potential for internal erosion along the outlet works conduit leading to dam breaching.
- Underdrains are often difficult to monitor and inspect.

If the backfill surrounding the outlet works conduit is poorly compacted or has cracked, a seepage pathway may exist along the conduit. Seepage flowing along this pathway could erode embankment material into cracks or open joints in the underdrain system. Backward erosion piping or internal erosion could start from this point. If undetected, the erosion could continue to progress, forming a lengthening “pipe” through the dam, or a large void within the dam core. Either the erosion would continue to progress upstream and lead to dam breach or the pipe or



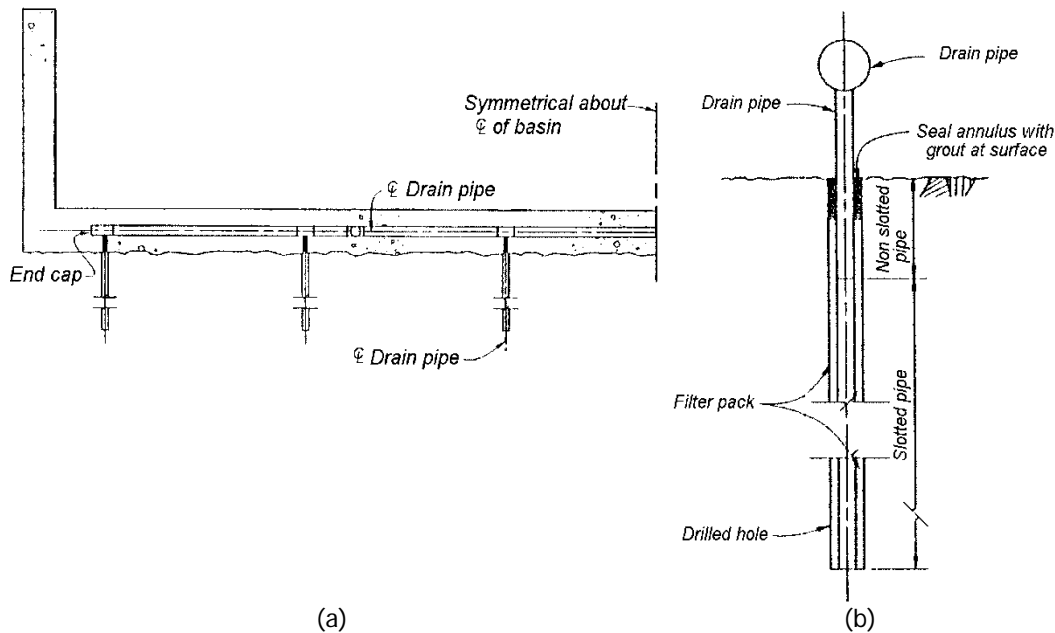

Figure 29.—Alternative underdrain system—(a) lateral (horizontal) collector drain with drilled/formed (vertical) weep hole drains. Note lateral collector drain is embedded in concrete to minimize disturbance to foundation. Cleanouts and covers for vertical drilled/formed drains are not shown, but are required for maintenance and inspection. (b) Typical detail of vertical drilled drain hole.

void could grow and collapse (sinkhole) leading to crest loss and potential overtopping. The [Virginia Smith Dam case history](#) in the appendix provides an example of an underdrain system that experienced such a problem.

### 2.6.7 Flow deflectors

Abrasion erosion damage has been a widespread problem for stilling basins for many years. Abrasion erosion damage occurs when materials, such as sand, gravel, or rock, are carried into the basin by recirculating flow patterns produced over the basin end sill during normal operation of a hydraulic jump energy dissipation basin. Once materials are in the basin, turbulent flow continually moves the materials against the concrete surface, causing severe damage, often to the extent that reinforcing bars are exposed. When repairs are made, many basins experience the same damage again within one or two operating seasons. The [Kinzua Dam case history](#) in the appendix is an example of unbalanced operations pulling debris into the basin. The [Pomona Dam case history](#) in the appendix provides photos from a model study showing the reverse flow roller bringing material back into the basin. The [Palisades Dam case history](#) in the appendix discusses the required repairs to an energy dissipator as a result of abrasion erosion damage.

Cleaning and repairing stilling basins require underwater diving and/or unwatering of the basin, which can be time consuming and require extended water delivery interruptions. Installing a flow deflector eliminates the high costs associated with these activities and reduces water delivery interruptions. This makes the basin self-cleaning under certain flow conditions, and materials are carried away, thus preventing abrasion erosion damage and the need for recurring repairs.

A number of studies have been conducted to try to understand the abrasion erosion problem and develop cost-effective solutions. Reclamation has conducted investigations to develop standard guidelines for the design of flow deflectors to reduce or eliminate stilling basin abrasion erosion damage.

A flow deflector is a device that is placed across the downstream portion of a stilling basin to change the flow pattern within the basin by directing the exiting flow downward. As shown in [figure 30](#), a flow deflector improves the flow pattern over the length of the basin and will:

- Reduce or eliminate abrasion erosion damage.
- Significantly increase basin life.
- Decrease costly repairs.
- Lessen frequent cleaning and maintenance.

The flow deflector consists of a reinforced steel plate panel that is attached in a vertical orientation to the walls of the stilling basin. One or two flow deflectors (staggered horizontally and vertically) are installed based on the geometry and flow characteristics of the basin, as determined by hydraulic analyses, scale modeling, and/or velocity profile field measurements.

The investigations performed by Reclamation determined that flow deflectors can be used to mitigate abrasion erosion damage by redirecting flow currents responsible for carrying abrasive materials into hydraulic jump stilling basins (Reclamation type II and III). Field evaluations of the stilling basins at Mason and Choke Canyon Dams were conducted to correlate with the model and to help refine and verify the final

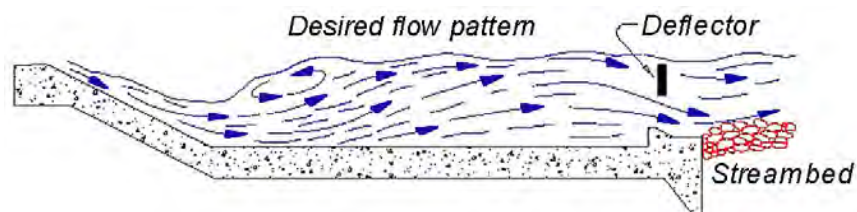

Figure 30.—Desired flow pattern avoids recirculating currents.

design. Two flow deflectors were installed in 2006 at Choke Canyon Dam (figure 31). The flow deflectors were furnished and installed as a component of a large concrete repair project for a total cost of \$57,000. The evaluations demonstrated that implementation of flow deflectors could result in substantial cost savings by reducing recurring operation and maintenance costs for basin repairs, unwatering, and interruptions in water deliveries. For further discussion of the flow deflector at Mason Dam, refer to the case history in the appendix.

In most cases, uniform operation of regulating gates discharging into a stilling basin is recommended. Careful attention should be paid to gate operation in cases where multiple gates are discharging. Unless a basin is properly designed, operation of fewer than all gates could result in flow back into the basin. This backflow can bring rocks back into the basin resulting in abrasion erosion. A staggered flow deflector configuration could be designed to be fairly effective for nonuniform operations where a splitter wall (section 2.6.2) is not utilized. A staggered configuration is usually the most effective design for a large range of flow conditions. Staggering of the flow deflector depends on basin geometry and the range of basin operations.

Velocity profiles would need to be measured for both uniform and nonuniform operations to determine if a staggered design could be effective over the full range. This is necessary during uniform operations since the jump will spread more uniformly across the width of the basin. If the same discharge is used through one conduit instead of two, the jet will be more concentrated/stronger, resulting in a stronger jump that may remain attached to a side wall on one side of the basin. This changes the elevation of the concentrated jet exiting the basin and therefore the effective elevation for the placement of the flow deflectors. Having the jump concentrated on one side may also produce a side roller that can bring materials into the basin, so a model study would likely be needed. A model study would help identify locations where the jump may attach to the basin sidewalls over a lower range of operations. However, a model study may not be necessary for the flow deflector design when only uniform flow operations need to be considered.

### **2.7 Selection of a Hydraulic Jump Stilling Basin**

The selection of the proper energy dissipator depends on energy content, downstream channel conditions, alignment and location with respect to the toe of the dam, other features (e.g., a powerplant, pumping plant, or access roads), and economic considerations. Generalized designs of hydraulic jump stilling basins have been developed, so future stilling basins can be designed without the need for additional model studies.

For outlet works with free-flow downstream conduits, the regulating gate or control valve is usually located upstream at the intake structure or in a gate chamber within the dam or through an abutment or reservoir rim. Free-flow, flat-bottom conduits



**Figure 31.**—Flow deflectors being installed at the downstream end of a stilling basin.

downstream from the regulating valve or gate typically lead to a transitional chute that directs the flow to the hydraulic jump stilling basin. The transitional chute is located between the conduit portal and the stilling basin. The floor convex curvatures and maximum flare angles in the chute should be determined so the flow will become uniformly distributed across the chute before entering the stilling basin. Otherwise, proper energy dissipation will not be obtained. The flow in the chute should be governed by open-channel flow criteria. To reduce the length of the chute, the beginning of the flare angles and the convex curve may be located inside the conduit.

The designer may want to consider sizing the width of the basin based on a maximum hydraulic jump of about 40 feet to limit the well height (for a cantilevered wall); see [section 2.6.1](#).

For outlet works with pressurized downstream conduits, the regulating gate or control valve is located at the downstream end. Flow emerging from the regulating gate is in the form of a free jet. The regulating gate and free jet must be pointed downward onto the chute floor, so the flow is uniformly distributed across the chute before entering the stilling basin. Otherwise, proper energy dissipation will not be obtained. The angle from horizontal for directing the free jet from the regulating gate ranges from 34 to 14 degrees. An angle of 30 degrees is typically used when the floor slope entering the basin is 2H:1V.

In the past, much credence has been given to restricting the design of a stilling basin to a certain maximum velocity or unit discharge because of cavitation concerns. For

example, a type III basin is restricted to maximum entrance velocities of 60 ft/s and maximum unit discharges of 200 ft<sup>3</sup>/s per foot. Others restrict the maximum unit discharge to 200 ft<sup>3</sup>/s per foot of basin width. Both of these limitations can be related to a head. The velocity of 60 ft/s corresponds to a head of 56 feet, whereas the 200 ft<sup>3</sup>/s per foot of basin width corresponds to a head of 16 feet using the definition of minimum head (specific energy at critical depth) given by:

$$H_{\min} = \frac{3}{2} \sqrt[3]{\frac{q^2}{g}} \quad \text{eq. 5}$$

where,

$$\begin{aligned} H_{\min} &= \text{minimum head (ft)} \\ q &= \text{unit discharge (ft}^3/\text{s per foot of basin width)} \\ g &= \text{acceleration due to gravity (32.2 ft/s}^2\text{)} \end{aligned}$$

The wide disparity between the two heads using these arbitrary criteria indicates that a different criterion should be used to determine the limitations of the flow. A better criterion is to consider the cavitation index at the beginning of the jump. The cavitation index is defined as:

$$\sigma = \frac{P - P_v}{\frac{\rho V^2}{2}} \quad \text{eq. 6}$$

where,

$$\begin{aligned} \sigma &= \text{cavitation index} \\ P &= \text{pressure at flow surface (atmospheric pressure + pressure related to} \\ &\quad \text{flow depth) (lb/ft}^2\text{)} \\ P_v &= \text{vapor pressure of water (lb/ft}^2\text{)} \\ \rho &= \text{density of water (lb-s}^2/\text{ft}^4\text{)} \\ V &= \text{average flow velocity (ft/s)} \end{aligned}$$

The cavitation index should be greater than 0.2 for a basin without appurtenances and greater than 1.0 for a basin with appurtenances. If the cavitation index is lower than these limits:

- The jump basin is not appropriate for a stilling basin without appurtenances ( $\sigma < 0.2$ ).
- The jump basin with appurtenances requires a specially formed baffle block ( $\sigma < 1.0$ ).

- The jump basin with appurtenances should not employ chute blocks unless they can be aerated ( $\sigma < 1.0$ ).

The criterion of 0.2 is based on cavitation damage experienced in spillways, and the criterion of 1.0 is based on the incipient cavitation index for chute and baffle blocks. For further discussion of cavitation, see [Reclamation \(1990\)](#).

The following sections provide guidance on the selection of the proper hydraulic jump stilling basin.

### 2.7.1 Reclamation stilling basins

From studies of existing structures and laboratory investigations, Reclamation has developed various types of standard stilling basin designs. Of these ten standard basins, six are considered to be hydraulic jump stilling basins (types I, II, III, IV, V, and VIII) and are described in this section. A type VI basin is an impact stilling basin and is discussed in [chapter 3](#). A type VII basin is either a slotted or solid submerged bucket used in spillway applications and is not discussed in this manual. A type IX basin is a baffled drop typically used on canals and channels as grade change structures and is discussed in [chapter 10](#). A type X basin is a flip bucket, as discussed in [chapter 4](#).

Standard Reclamation stilling basin designs suitable for stilling flows for the various forms of hydraulic jumps can be related to the Froude number of the incoming flow. No special stilling basin or appurtenances are needed to still flows where the Froude number of the incoming flow is less than 1.7, except that the channel length beyond the point where the depth starts to change should be about four times the conjugate depth. Additional guidance on standard basin types I through X is available in [Reclamation's Hydraulic Design of Stilling Basins and Energy Dissipators \(1984\)](#).

#### 2.7.1.1 Type I basin

The type I basin develops a hydraulic jump occurring on a horizontal floor with no appurtenances. Turbulence in the jump dissipates the energy. However, this basin is usually not very practical because of its long length, lack of control, and the fact that the hydraulic jump will be in the form of a weak jump or a prejump stage. Type I basins are used for Froude numbers that are less than 1.7 to 2.5. [Figure 20](#) shows the recommended basin lengths for a type I basin based on the Froude number of the incoming flow and the conjugate depth ( $D_2$ ).

#### 2.7.1.2 Type II basin

The type II basin ([figure 32](#)) contains chute blocks at the upstream end of the basin and a dentated end sill. The chute blocks create shear zones that generate energy-dissipating turbulence resulting in a shorter length of jump than would be possible

without them. The purpose of the end sill is to prevent downstream erosion, and it does not contribute significantly to energy dissipation. Baffle blocks are not used in the type II basin because of the relatively high approach velocities and the potential for cavitation.

The type II basin was developed for Froude numbers greater than 4.5 where a true hydraulic jump forms and primarily dissipates energy. The type II basin is not recommended for Froude numbers less than 4.5 where the hydraulic jump becomes unstable. The type II basin was designed for both large unit discharges and high approach velocities. The type II basin should never be designed for a tailwater depth less than the computed conjugate depth. The tailwater depth (figure 32) should be increased by a minimum of 5 percent of the computed conjugate depth as a factor of safety against sweepout. Figure 20 shows the recommended basin lengths for a type II basin based on the Froude number of the incoming flow and the conjugate depth ( $d_2$ ). The recommended type II basin length is also shown in figure 32. The basin length is greater than that indicated for the type III basin.

The type II basin is recommended for unit discharges up to 500 ft<sup>3</sup>/s per foot of basin width, provided the jet entering the basin is reasonably uniform in both velocity and depth. For larger unit discharges, a model study or selection of an alternate energy dissipator is recommended.

### 2.7.1.3 Type III basin

The type III basin (figure 33) contains an additional set of blocks (baffle blocks) within the basin to create additional turbulence. Cavitation and transverse loads on the baffle blocks have required the development of special shapes for high head installations. The addition of the chute blocks and the baffle blocks permits the length of the stilling basin to be reduced. The energy dissipation for this basin is based on the change in momentum of the water through the structure.

For Froude numbers higher than 4.5, a true hydraulic jump forms. A type III basin can be used for Froude numbers higher than 4.5. The type III basin is limited to velocities less than 60 ft/s, and the cavitation index should be considered as discussed in section 2.7. A type II basin is better suited for incoming velocities greater than 60 ft/s. For a type III basin, the tailwater depth should at least be equal to the computed conjugate depth, as shown on figure 33.

A type III basin is shorter than a type II basin and is typically used for canal structures, small outlet works, and small spillways. The reduction in length is mainly achieved by baffle blocks. Figure 33 shows the recommended basin lengths for a type III basin based on the Froude number of the incoming flow and the conjugate depth ( $d_2$ ). The recommended type III basin length is also shown on figure 20.

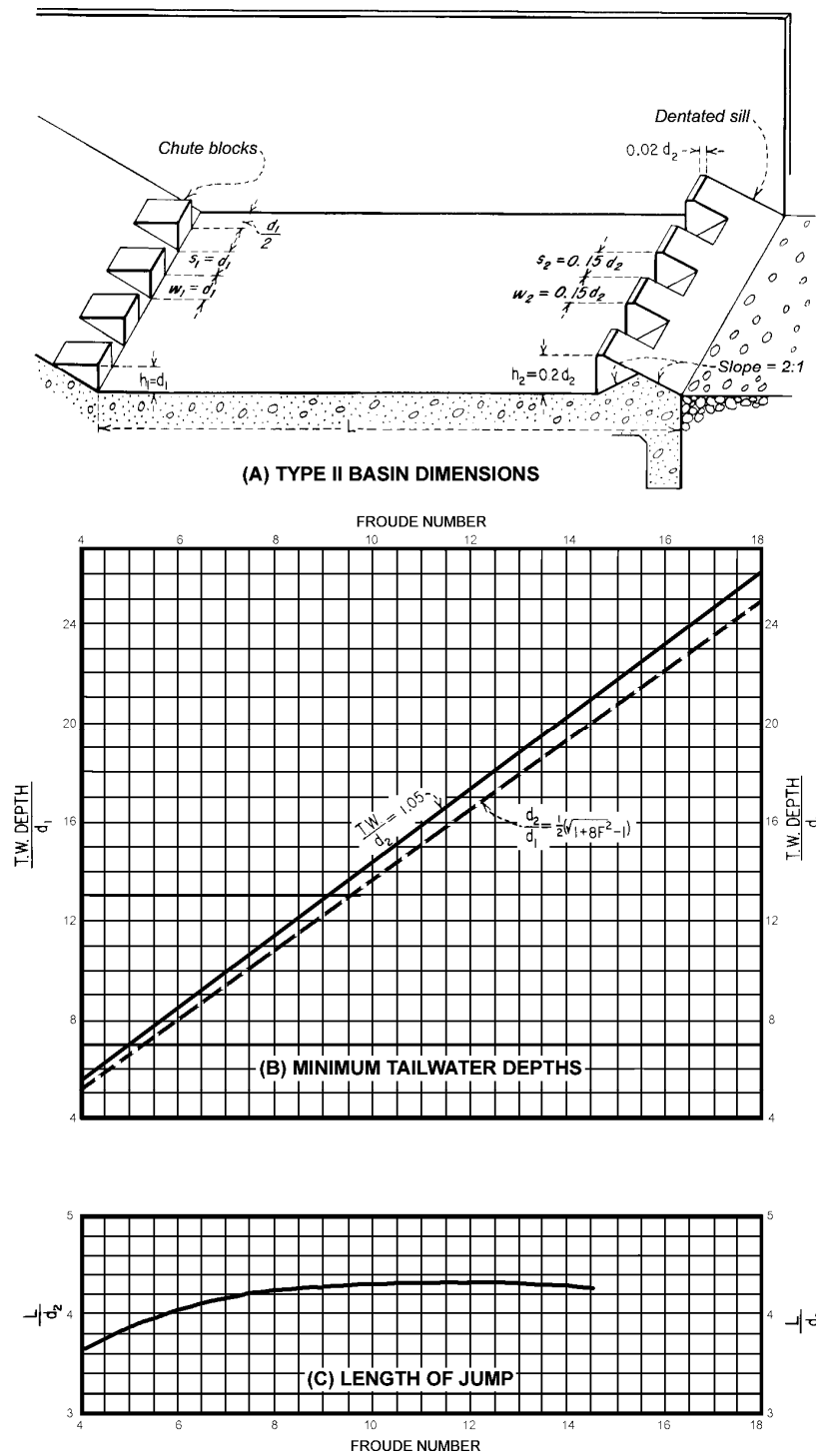
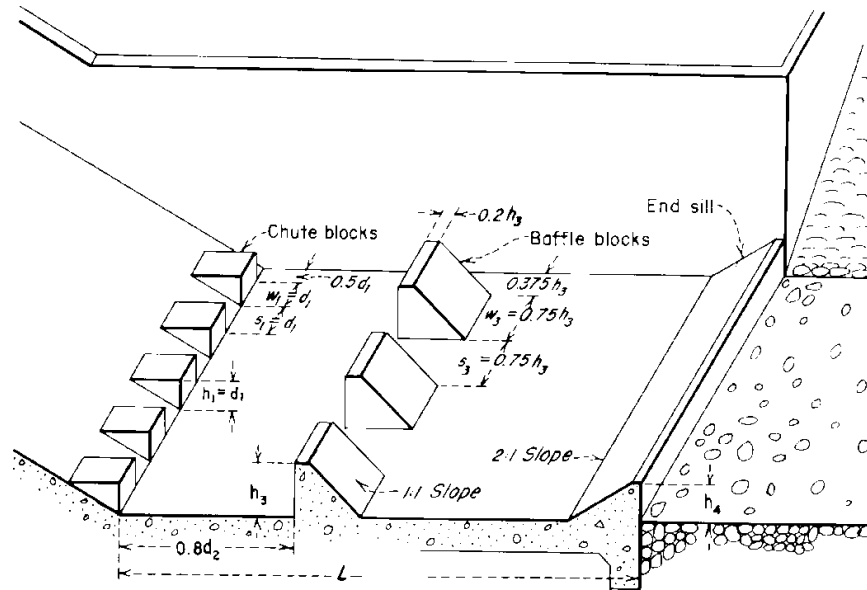

Figure 32.—Type II basin characteristics for Froude numbers greater than 4.5 and incoming velocities greater than 60 ft/s (Reclamation, 1987, p. 395). See Reclamation (1987) for information related to variables as denoted in this figure.





(A) Type III basin dimensions

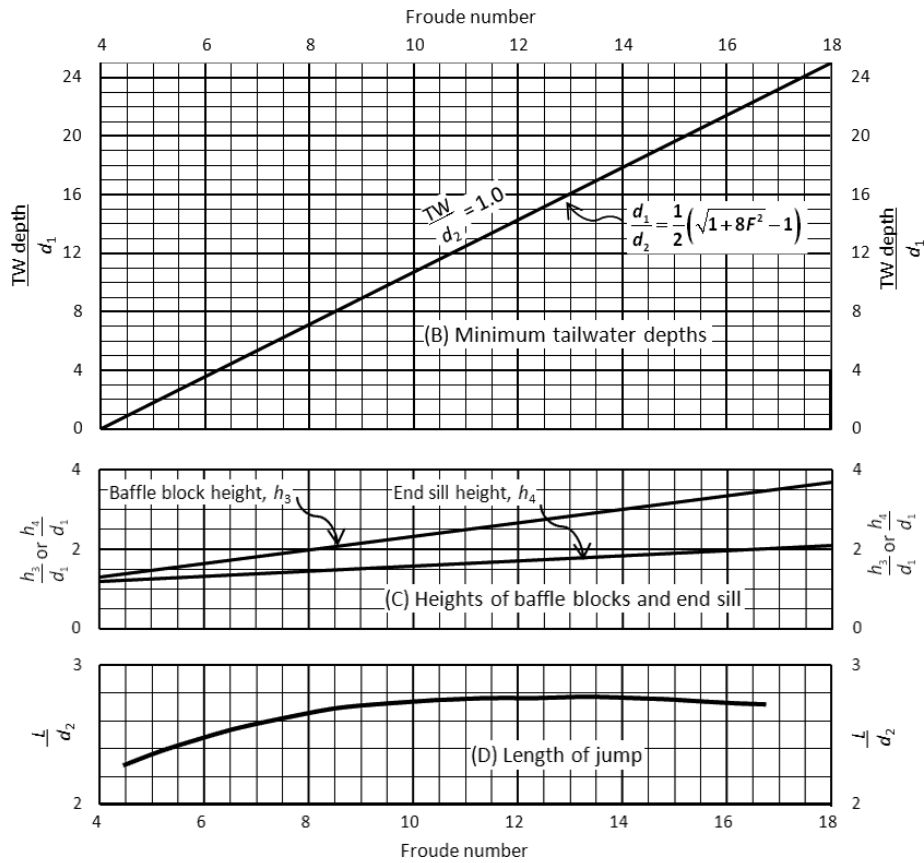

Figure 33.—Type III basin characteristics for Froude numbers above 4.5 and incoming velocities less than 60 ft/s (Reclamation, 1987, p. 393). See Reclamation (1987) for information related to variables as denoted in this figure.

A type II basin is considered too conservative for small unit discharges and limited approach velocities. The type III basin is limited to a maximum 200 ft<sup>3</sup>/s per foot of basin width for the design unit flow rate.

#### 2.7.1.4 Type IV basin

For low Froude numbers between 2.5 and 4.5, the hydraulic jump is not very stable and is in the transition stage because it is not fully developed. The approaching jet oscillates intermittently from the bottom of the basin up to the water surface. Each oscillation generates a wave that persists downstream and is difficult to dampen. Waves from the hydraulic jump are a concern for this range of Froude numbers because the waves persist beyond the end of the jump. Waves are destructive to earth-lined canals or riprap and produce undesirable surges.

The type IV basin is typically used for outlet works, canal structures, and diversion dams. Two separate type IV basins have been developed and have proved relatively effective for dissipating the bulk of the energy of the flow. However, the wave action propagated by the oscillating flow cannot be entirely dampened. Auxiliary wave dampeners or wave suppressors must sometimes be used to provide a smooth flow surface downstream. Figure 34 shows an example of a wave suppressor at the



**Figure 34.**—This wave suppressor (also known as an underpass-type) was constructed after completion of the stilling basin to prevent unanticipated waves exiting the basin from overtopping the downstream canal lining. Overtopping could result in either undermining of the soil supporting the canal lining or introduction of uplift pressures beneath the canal lining. Note the formed openings through the deck of the wave suppressor.

downstream end of a stilling basin. For guidance in designing a wave suppressor, see [Reclamation's \*Hydraulic Design of Stilling Basins and Energy Dissipators\* \(1984, pp. 47–56\)](#). The efficiency of a hydraulic jump stilling basin at low Froude numbers is less than 50 percent. The need to design this type of basin can be avoided by selecting stilling basin dimensions that increase the Froude number and provide flow conditions that fall outside the range of the transition stage. Altering the dimensions of the structure to produce a higher Froude number or using an alternative energy dissipator, such as a baffled drop structure, should also be considered for Froude numbers between 2.5 and 4.5. Increasing the width of the basin to decrease the depth of the incoming flow and increase the Froude number would be one alternative.

The 1958 version of the type IV basin has large chute blocks and an optional solid end sill, as shown in [figure 35](#). The 1978 version, also referred to as the alternative low Froude number stilling basin, has chute blocks, baffle piers, and a dentated end sill, as shown in [figure 36](#). The 1978 version of the type IV basin is shorter than the 1958 version. Because of the tendency of the jump to sweep out and as an aid in suppressing wave action, the tailwater depth in the basin should be at least 5 to 10 percent greater than the computed conjugate depth.

### 2.7.1.5 Type V basin

The type V basin consists of forcing the hydraulic jump to occur on a sloping chute floor. The purpose of a type V basin is to minimize the amount of excavation and concrete required for the chute and stilling basin. Type V basins are typically used on large spillway structures and will be discussed only for illustrative purposes in regards to hydraulic jump formation.

[Reclamation \(1984, pp. 58–79\)](#) performed a series of model tests investigating a hydraulic jump on a slope measuring the discharge, the average depth of flow entering the jump, the length of the jump, the tailwater depth, and the slope of the chute floor. The model tests showed that the amount of energy dissipation with the jump on a slope is as effective as the jump occurring on a horizontal stilling basin.

The hydraulic jump may occur in several forms on a slope as shown on [figure 37](#). Case A has the jump occurring on a horizontal slope. In case B, the toe of the jump forms on the slope, and the jump ends over the horizontal slope. In case C, the toe of the jump is on the slope, and the end of the jump is at the change in slope to horizontal. In case D, the entire jump forms on the slope. Another case not shown is the jump occurring on an adverse slope. Cases C and D are essentially the same, and cases B, C, and D are also known as drowned-out jumps.

For case D, with the hydraulic jump occurring on a slope, the ratio of the tailwater depth to initial depth for a given slope and Froude number has been developed from the model data and is shown in [figure 38](#). The length of the jump for case D was

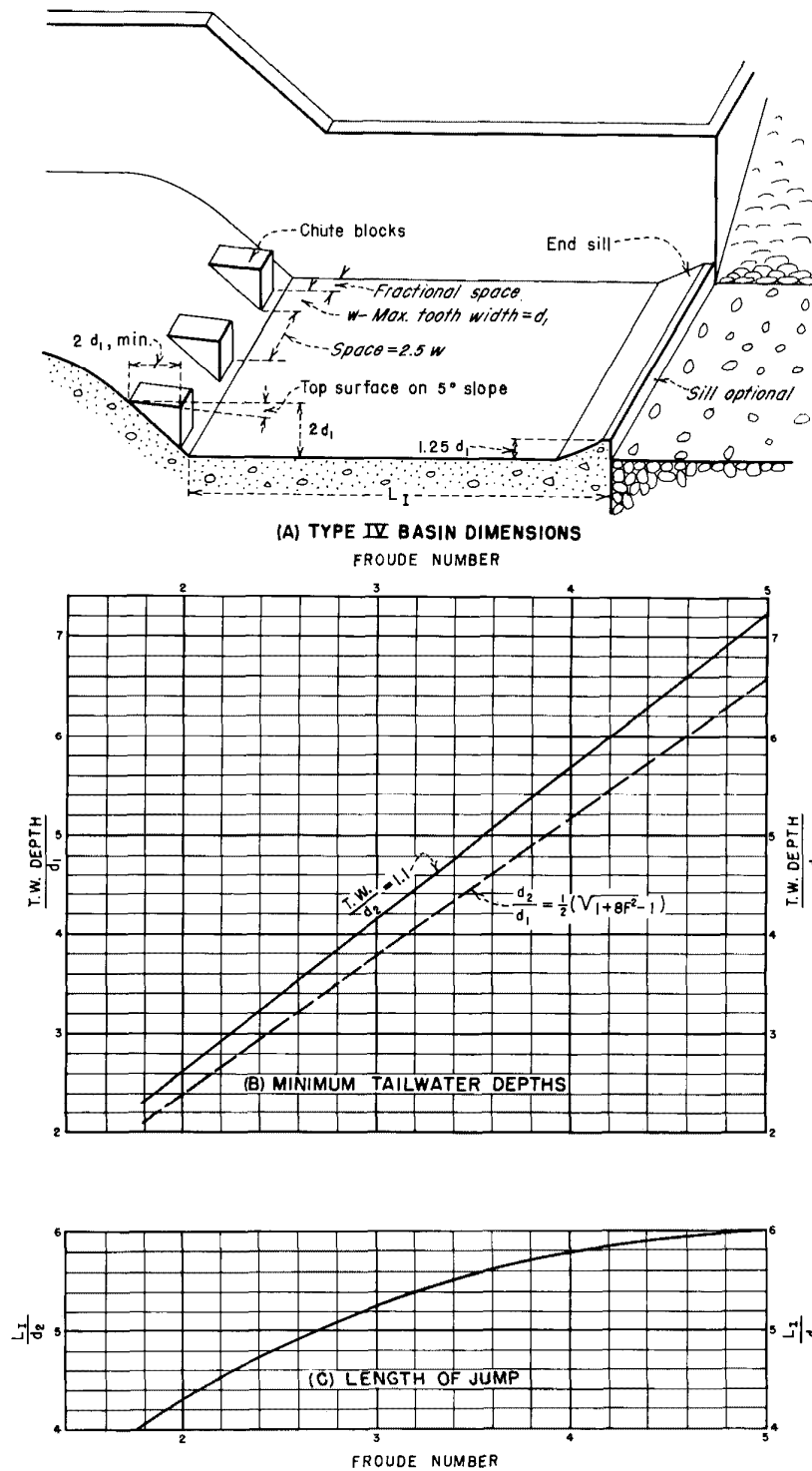

Figure 35.—Type IV basin characteristics for Froude numbers between 2.5 and 4.5 (Reclamation, 1987, p. 390). See Reclamation (1987) for information related to variables as denoted in this figure.

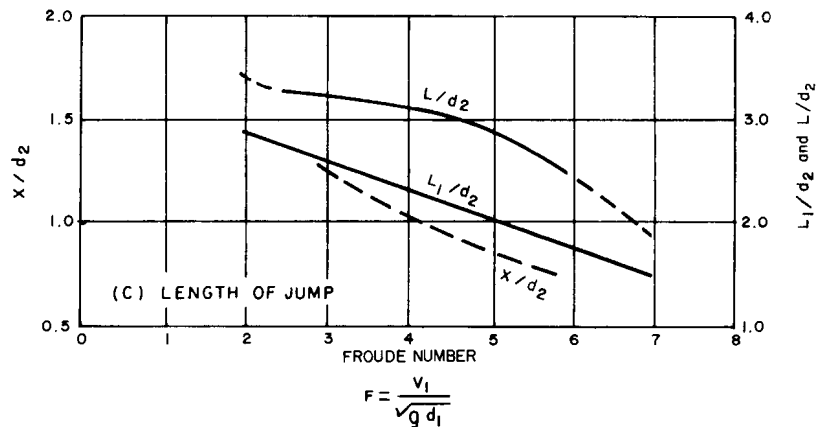
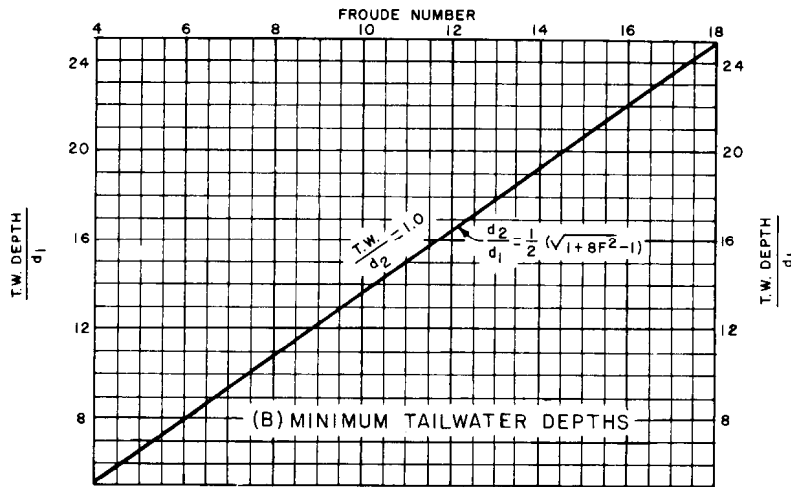
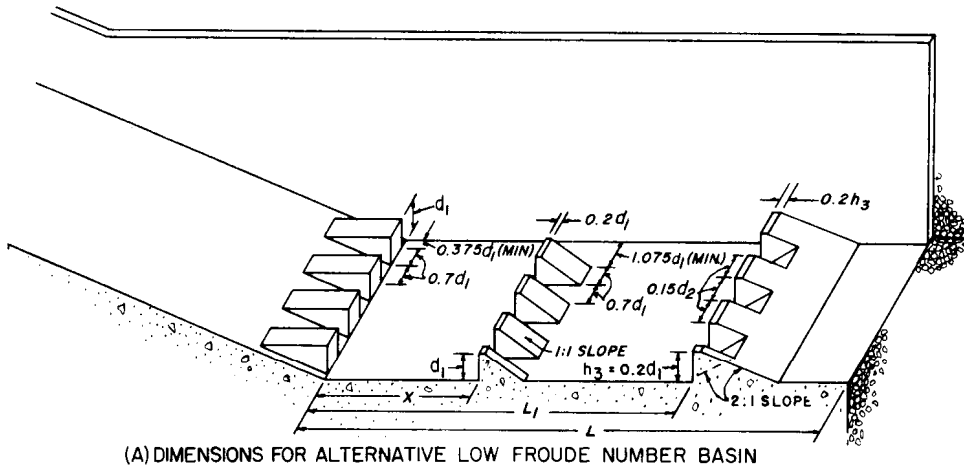

Figure 36.—Alternative low Froude number basin characteristics (Reclamation, 1987, p. 392). See Reclamation (1987) for information related to variables as denoted in this figure.

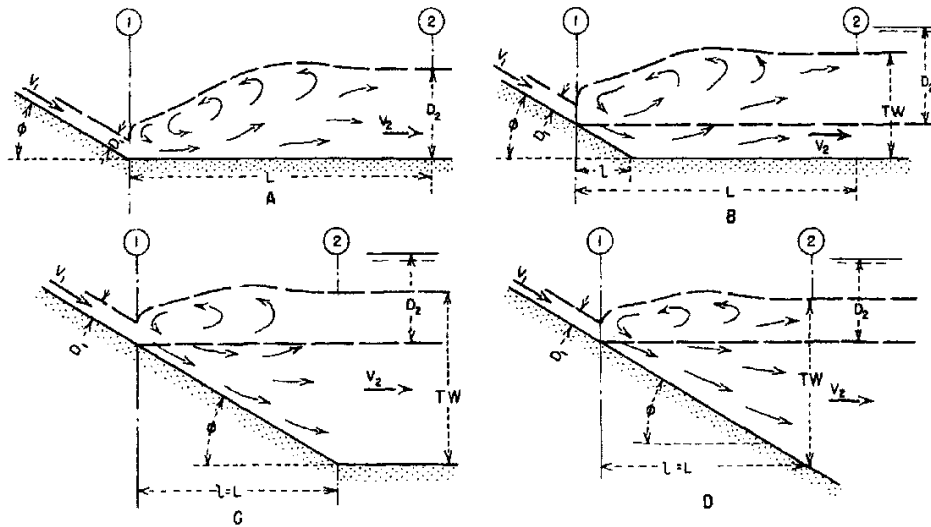

Figure 37.—Hydraulic jump on a slope (Reclamation, 1984, p. 58). See Reclamation (1987) for information related to variables as denoted in this figure.

also determined from model data and is shown in figure 39. The length of the jump depends upon the Froude number, the tailwater, and the slope.

Case B is the more common with the hydraulic jump occurring over both the sloping chute floor and the horizontal stilling basin. The ratio of the tailwater depth to the conjugate depth for a given slope and Froude number has been developed from the model data and is shown in figure 40. The length of the jump for case B should be taken from figure 39 for case D. This figure is for a continuous slope, but can also apply to case B. Figure 41 shows an example of a type V stilling basin.

The first consideration in design of a hydraulic jump on a slope should be to determine the slope that will minimize the amount of excavation and concrete for the maximum discharge and tailwater condition. The height of the jump is checked to determine whether the tailwater depth is adequate for the intermediate discharges. The tailwater depth usually exceeds the required jump height for the intermediate discharges resulting in a slightly submerged condition for intermediate discharges, but the performance will be acceptable. Should the tailwater depth be insufficient for intermediate flows, it would be necessary to increase the depth using a steeper slope.

The sloped portion of the basin should be designed to take full advantage of the entire sloped length for the design discharge. There is no advantage to having a portion of the sloped basin not being utilized. The model tests showed that the slope itself has little effect on the performance of the stilling basin. The sloped portion of the basin should be positioned so that the upstream toe of the jump forms at the upstream end of the slope for the design discharge. Raising or lowering

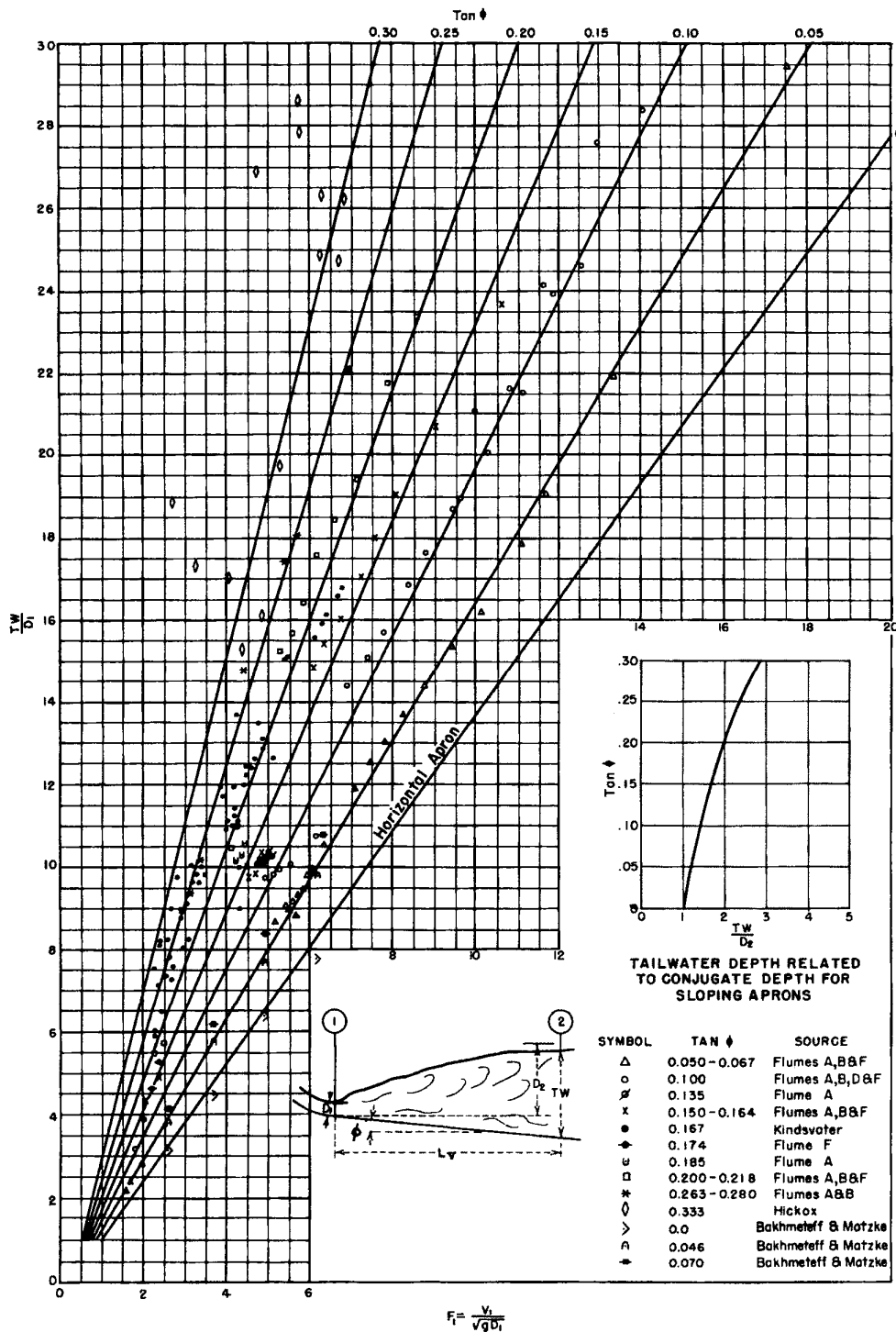

Figure 38.—Ratio of tailwater to initial depth for jump on slope (type V basin, case D) (Reclamation, 1984, p. 63). See Reclamation (1984) for information related to variables as denoted in this figure.



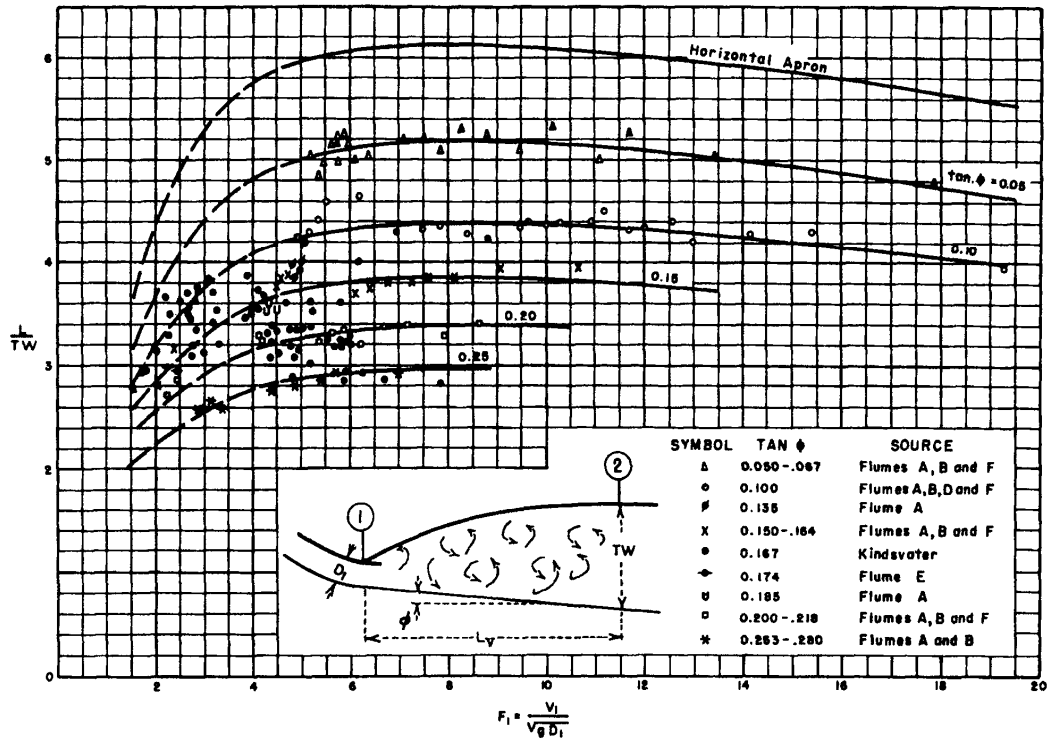

Figure 39.—Ratio of length of jump to tailwater on slope (type V basin, case D) (Reclamation, 1984, p. 64). See Reclamation (1984) for information related to variables as denoted in this figure.

of the basin, or changing the original slope entirely may be required to meet this hydraulic requirement.

The model studies concluded that extra tailwater depth is required for a hydraulic jump of a given Froude number to form on a slope rather than on a horizontal stilling basin. The primary concern is having enough tailwater depth to move the toe of the jump up the slope. The tailwater depth for the design discharge should be at least 5 percent larger than the minimum computed conjugate depth. For Froude numbers greater than 9, a 10-percent factor of safety is recommended.

The hydraulic jump occurring on a slope is typically longer than the same jump on a horizontal floor. Economically designing the basin to confine the entire jump may not be possible. Model tests indicate that approximately 60 percent of the length of the jump is needed for the basin at most installations. Longer or shorter basins would depend on the quality of the downstream channel bed.



# Outlet Works Energy Dissipators

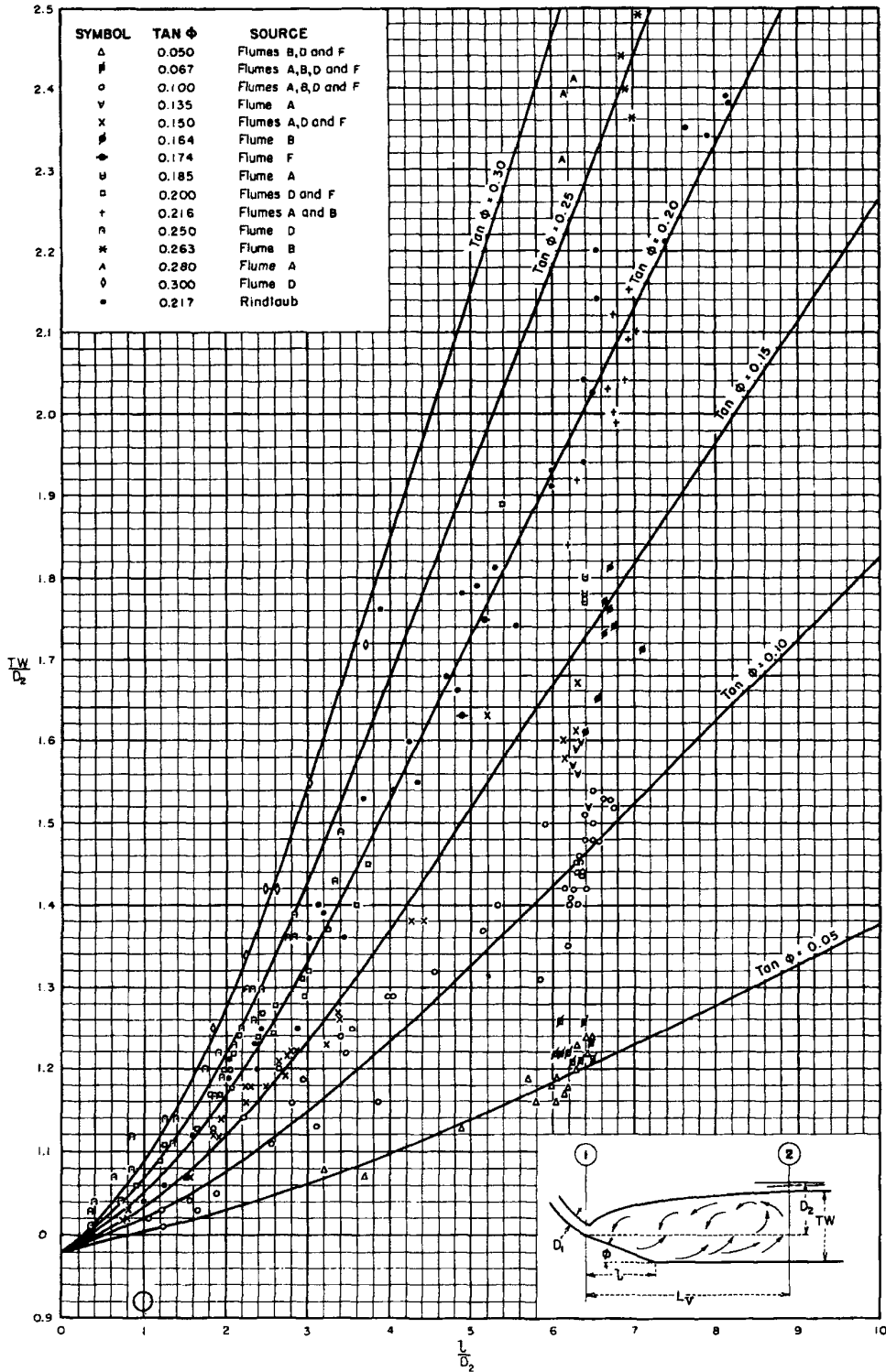
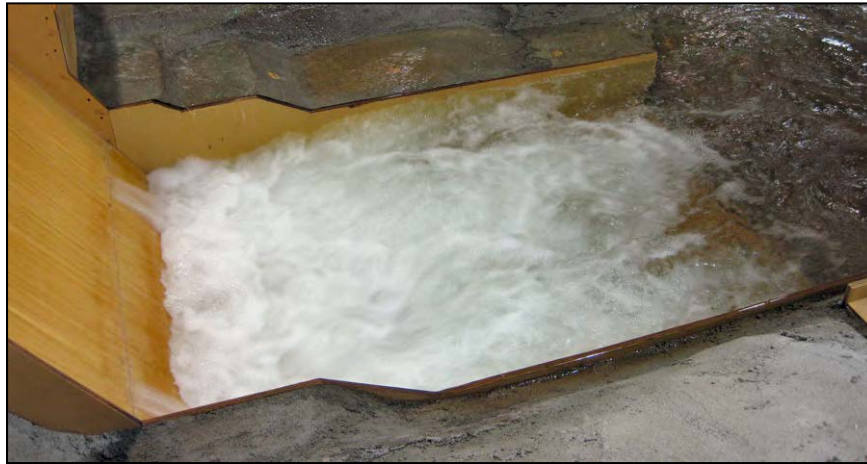

Figure 40.—Ratio of tailwater to conjugate depth (type V basin, case B) (Reclamation, 1984, p. 71). See Reclamation (1984) for information related to variables as denoted in this figure.



**Figure 41.**—This figure shows a hydraulic jump occurring in a 1:48-scale model of a type V stilling basin for a spillway. The operating condition equates to a prototype discharge of 60,000 ft<sup>3</sup>/s. The 242-foot wide stilling basin has an 0.8:1 slope for the upstream 178.7-foot length and is horizontal for the downstream 146.8-foot length. The stilling basin has a 15-foot high solid end sill. The figure most closely depicts the condition discussed in case C where the upstream toe of the hydraulic jump occurs on the slope and the downstream end of the jump is at the junction of the slope and the horizontal apron (for this example, where the break in floor slope goes from 0.8:1 to horizontal).

A small, solid, triangular end sill, placed at the end of the basin, is the only appurtenance needed in a type V basin. This end sill serves to lift the flow as it leaves the basin and thus acts to control scour.

A primary consideration in the design of a hydraulic jump stilling basin is a structure that can be designed and constructed at a reasonable cost. The decision to use a type V sloping basin is based on which arrangement will give the greatest economy for the design discharge. The slope and overall shape of the basin are based on economics, not hydraulics.

#### 2.7.1.6 Type VIII basin

The type VIII basin was designed for high head outlet works using a hollow-jet valve for discharge control (Reclamation, 1960; Reclamation, 1984, pp. 127–152). The hollow-jet valve stilling basin is typically about 50 percent shorter than a conventional basin. This type of basin is usually constructed within or adjacent to the powerhouse structure to save space and reduce cost. Regardless of the valve opening or head, the outflow from a hollow-jet valve has the same pattern, an annular or hollow-jet of water of practically uniform diameter throughout its length. The type VIII basin takes advantage of the hollow-jet shape and is not recommended for concentrated water jets. Figure 42 shows an example of a type VIII basin.

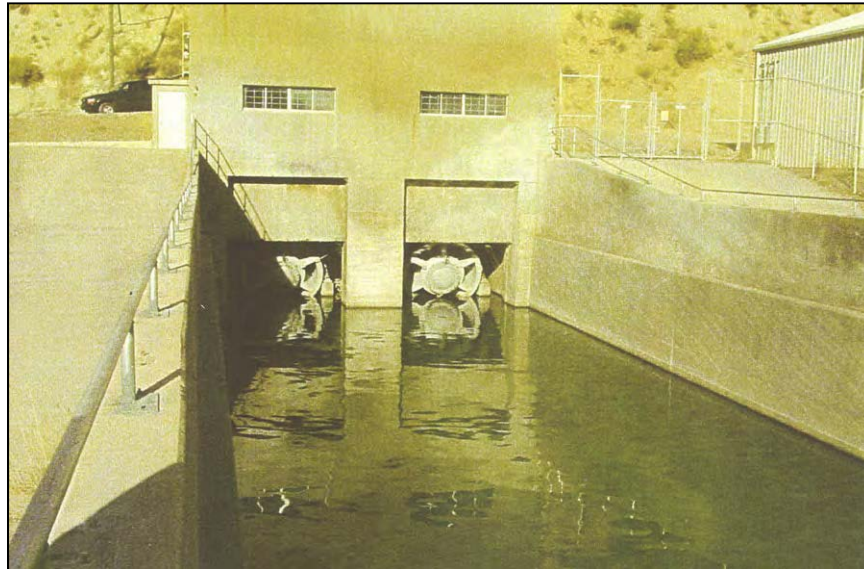

Figure 42.—Two 72-inch diameter hollow-jet valves and stilling basin.

Hollow-jet valves were designed as a type of reverse needle valve, with the seal at the upstream end of the needle instead of downstream. They are operated either hydraulically or by electric motor-operator. Hollow-jet valves provide higher discharge coefficients than needle valves, but they are very costly to fabricate because of the complex shapes used in the needle portion and upstream body. Cavitation damage is a constant issue with the valve, especially around the splitters, and the valve has a minimum opening restriction due to the cavitation problem. The valve is not commonly used because of the high cost of obtaining castings and problems with damage from cavitation. The fixed-cone valve ([section 7.1](#)) is much more common now.

In early design of this basin, the control valve from an outlet works discharged horizontally onto a trajectory-curved floor that was sufficiently long to provide a uniformly distributed jet entering the hydraulic jump stilling basin. This resulted in an extremely long structure. When two valves were used side by side, a long dividing wall was also required. Hydraulic model tests have shown that the length could be significantly reduced by turning the control valve downward. If the angle is too flat, the jet from the control valve does not penetrate the pool in the stilling basin, but skips along the surface of the tailwater. If the angle is too steep, the jet penetrates the pool, but rises almost vertically to form an objectionable boil on the water surface. Model studies have shown the optimum angle for a hollow-jet valve is approximately 24 degrees discharging on a chute floor sloped at 30 degrees ([figure 43](#)).

The hollow-jet valve should be placed with the center of its downstream end at or above the tailwater elevation. The water jet sweeps the tailwater away from the

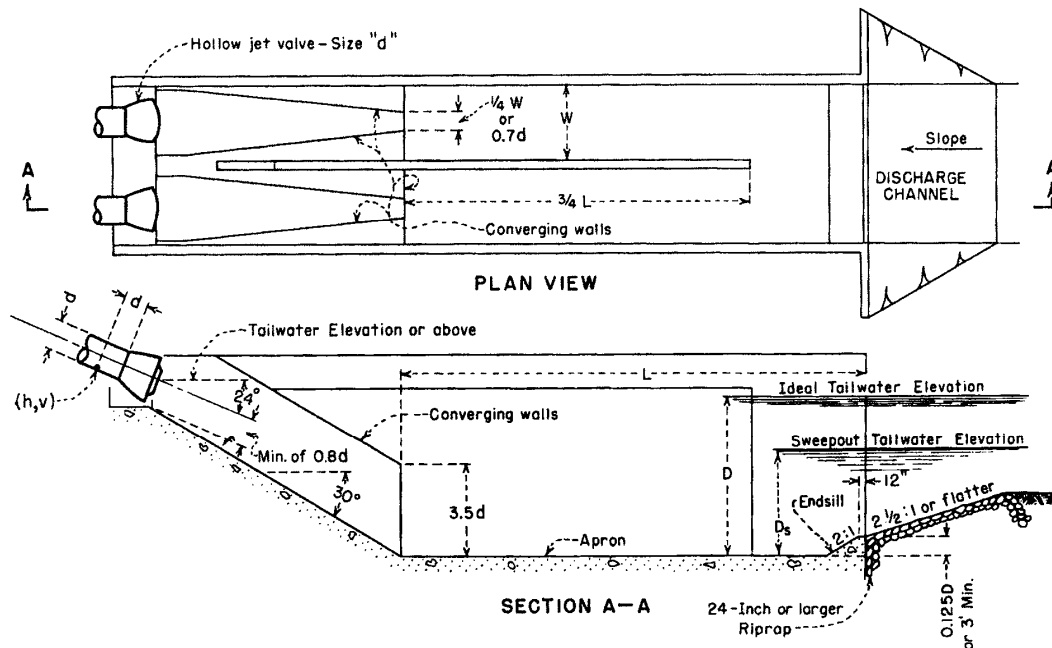

Figure 43.—Hollow-jet valve stilling basin generalized design (Reclamation, 1984, p. 136). See Reclamation (1984) for information related to variables as denoted in this figure.

downstream face of the valve sufficiently to allow ventilation of the valve. The hollow-jet valve should not be operated in a submerged condition.

Converging side walls along the sloping chute floor are used to compress the hollow-jet into a thinner jet with greater ability to penetrate the tailwater pool in the basin. The converging walls are used until the jet is fully submerged. The converging walls typically extend to the downstream end of the sloping chute floor. Sudden expansion of the jet as it flows past the end of the converging walls accounts for most of the energy loss.

For outlet works with two control valves placed a minimum distance apart and aligned to discharge parallel jets, a dividing wall is needed between the valves for satisfactory hydraulic performance. Model tests have shown that when both valves are discharging without a dividing wall, the flow sways from side to side producing longitudinal surges in the basin pool. This action occurs because the surging downstream from each valve has a different period and, the resulting harmonic motion becomes amplified. When only one valve is discharging, conditions are worse; the depressed water surface downstream from the operating valve induces flow from the higher water level on the nonoperating side. To provide acceptable operation with one valve operating, the dividing wall should extend at least three-fourths of the basin length or more. A full length center wall may be desirable.

The ideal length of the stilling basin exists where the bottom flow currents begin to rise from the basin floor of their own accord, without assistance from the end sill. The water surface directly above and downstream from this point is fairly smooth, indicating that the stilling action has been completed. Model studies have shown that basins appreciably longer than ideal tend to draw in abrasive material from the downstream channel. Basins shorter than ideal have a tendency to scour in the downstream channel. Therefore, the point at which the currents turned upward from the basin floor, plus the additional length required for an end sill, was determined to be the optimum length of the basin. The floor of the stilling basin is sometimes referred to as the apron. Dentates are not required on the end sill.

Model tests have shown that a stilling basin that is too wide results in the stilling action becoming unstable due to the flow not occupying the full width of the basin. A basin that is too narrow extends the stilling action beyond the ideal length of the basin. Additional basin width cannot be substituted for some of the required length or depth of the basin. The width may be selected to fit a particular space requirement. See the [Navajo Dam case history](#) in the appendix for an example of a hollow-jet valve stilling basin.

### 2.7.2 USACE stilling basin

The USACE has a stilling basin that is similar to the Reclamation type III basin, but has different design criteria based on USACE physical model testing at its Engineering Research and Development Center (ERDC) in Vicksburg, Mississippi (formerly Waterways Experiment Station). The summary of the design is contained in the USACE's EM 1110-2-1602, *Hydraulic Design of Reservoir Outlet Works* (1980). Refer to [chapter 5](#) and the examples in that publication (appendix E for the transition and appendix F for the parabolic drop and stilling basin).

The USACE publication contains information on how to design the transition from a circular conduit to a rectangular chute and recommends guidance on calculating the parabolic transition to the stilling basin itself. The publication also describes a “low-level outlet with respect to tailwater” condition. Although the stilling basin functions very well at high flows, this condition occurs at low tailwater elevations. The condition allows large eddies to form at low flows near the stilling basin walls, drawing debris and stone on the parabolic slope, causing concrete erosion. The publication discusses how to check for this condition and how to design the outlet to prevent it.

The stilling basin floor elevation should be between  $0.85d_2$  and a full  $d_2$  below the design tailwater elevation range where  $d_2$  is the conjugate depth. The basin length, baffle pier size and spacing, and end sill height are all based on  $d_1$  or  $d_2$  depths where  $d_1$  is the initial depth. Variations in the stilling basin length are discussed for various ranges of Froude numbers and downstream material conditions. The basin may



have zero, one, or two rows of baffle piers depending on the design flow conditions. Figure 44 shows a plan and profile of the USACE stilling basin design.

Additional information on how to design the downstream channel and erosion protection are presented in the publication. This includes recommended downstream channel profile to prevent flow eddies leaving the stilling basin from pulling downstream riprap into the stilling basin. This riprap can cause concrete erosion or ball milling in the stilling basin. The recommended channel profile is shown in figure 45.

### 2.7.3 SAF stilling basin

The SAF stilling basin was developed from model studies at the St. Anthony Falls Hydraulic Laboratory, University of Minnesota, for use on small drainage structures. The purpose of the model studies was to develop a generalized design guidance for an efficient and economical outlet structure for dissipating energy in high velocity flow. The SAF stilling basin is recommended for use on small structures such as small spillways, outlet works, and small canal structures where the Froude number is between 1.7 and 17. The reduction in basin length achieved through the use of appurtenances designed for this basin is about 80 percent. The Reclamation type III basin is similar in design, but has a higher factor of safety against the hydraulic jump

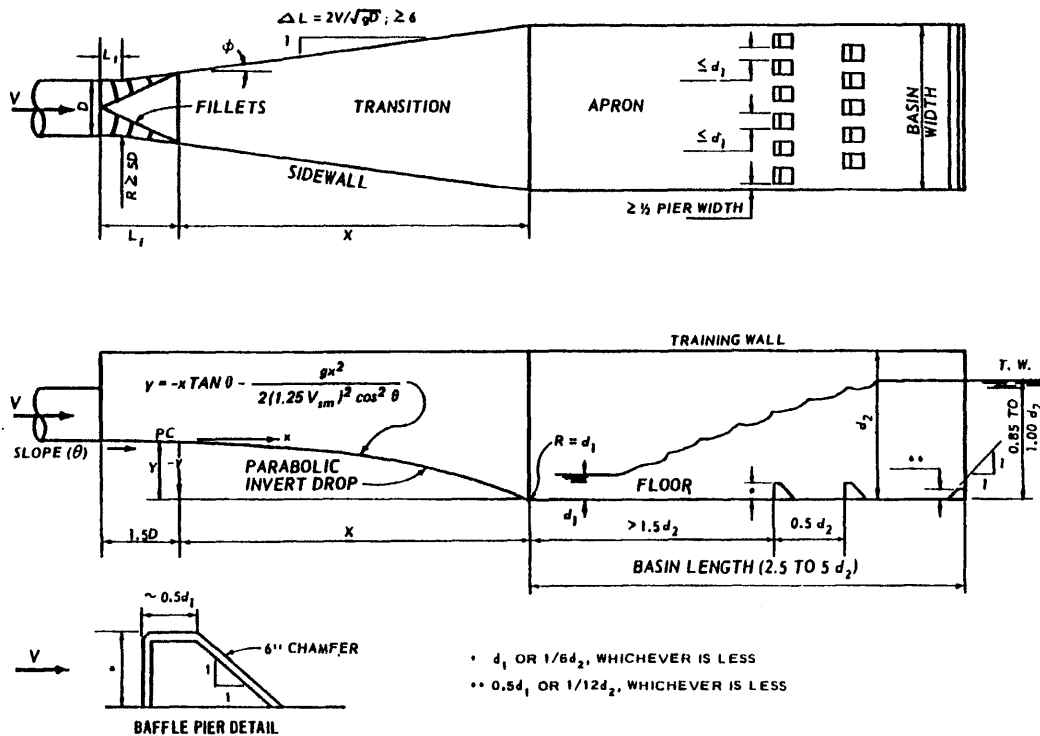

Figure 44.—USACE stilling basin layout (USACE, 1980, p. C-41). See USACE (1980) for additional discussion of the information shown in this figure.

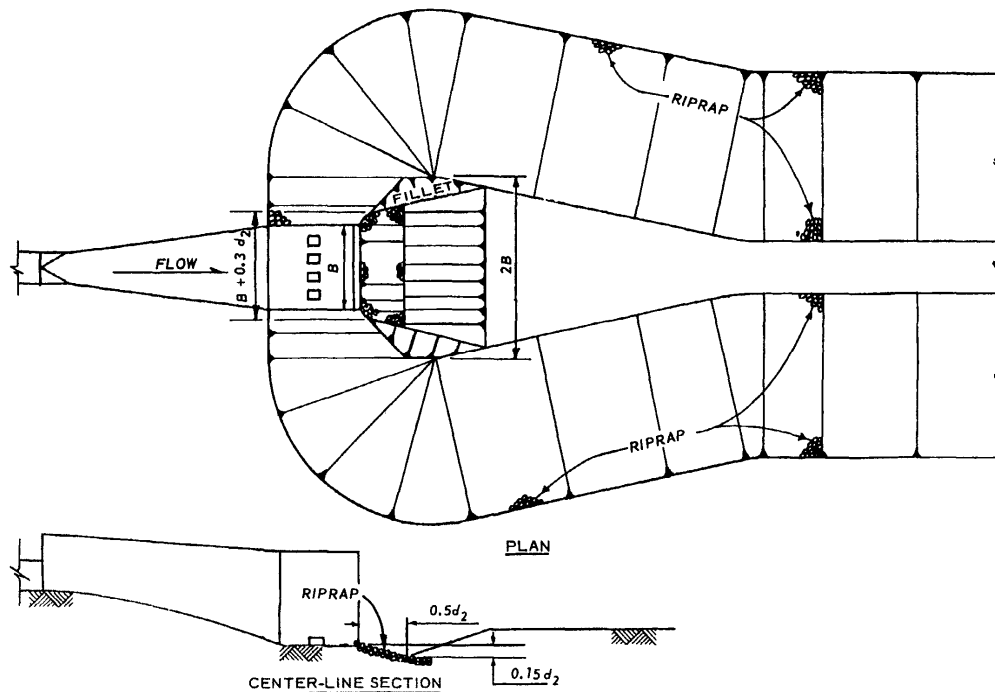

Figure 45.—Channel profile to prevent flow eddies leaving the USACE stilling basin from pulling downstream riprap into the stilling basin (USACE, 1980, p. C-43). See USACE (1980) for additional discussion of the information shown in this figure.

sweeping out of the basin. The type III basin is reduced in length by about 60 percent with the appurtenances. Thus, the SAF basin is shorter and more economical, but has a lower factor of safety against sweepout. Blaisdell (1959) uses the kinetic flow factor in the design of the SAF basin, but refers to it as the Froude number. The square root of the kinetic flow factor used in Blaisdell (1959) is the actual Froude number. Many of the dimensions of the SAF stilling basin are based on the kinetic flow factor ( $v_1^2/gd_1$ ) so this distinction is critical.

The characteristics and proportions of the SAF stilling basin have been determined over a wide range of conditions expected in the field, and the performance can be predicted without additional model studies. The SAF stilling basin is very economical to construct because the size of the SAF stilling basin has been reduced to a minimum that will ensure protection to the structure and prevent excessive erosion in the downstream channel. Use of the SAF stilling basin under actual field conditions has demonstrated its effectiveness and has verified the predictions based on the model studies. An example of an SAF type hydraulic jump stilling basin is shown in figure 46.

The SAF stilling basin uses chute blocks at the entrance of the basin to increase the inflow depth and break up the high velocity flow into a number of small streams.



Figure 46.—SAF stilling basin.

Baffle blocks or floor blocks are used to remove energy from the water impacting against the blocks and create turbulence. The floor blocks are placed downstream from the openings between the chute blocks and should occupy between 40 and 55 percent of the stilling basin width. A solid end sill is used to deflect the flow along the stilling basin floor upward and away from the bed of the downstream channel. Sloping wing walls (also referred to as triangular wing walls) are used at the end of the stilling basin to protect and retain the fill. The top of the wing walls should have a 1:1 slope. Model studies showed that the best orientation of the sloping wing walls is at an angle of about 45 degrees to the centerline of the stilling basin. A cutoff wall of nominal depth is used at the end of the stilling basin to prevent scour from undermining the basin. The depth of the cutoff wall is greater than the expected maximum depth of erosion at the end of the stilling basin. Scour at the downstream end is not expected to go below the thickness of the stilling basin floor slab.

Proportions of the SAF stilling basin are shown in [figure 47](#). For guidance on design of the SAF Basin, see [Blaisdell \(1959\)](#).

The SAF stilling basin was designed to provide an economic spillway stilling basin. As a spillway stilling basin, the design discharge is only approached during relatively infrequent flood events, during which some damage may be acceptable. The hydraulic jump is not completely contained within the basin at discharges approaching the design event, and subsequent scour may be expected downstream from the basin. Although some scour may be acceptable for relatively infrequent



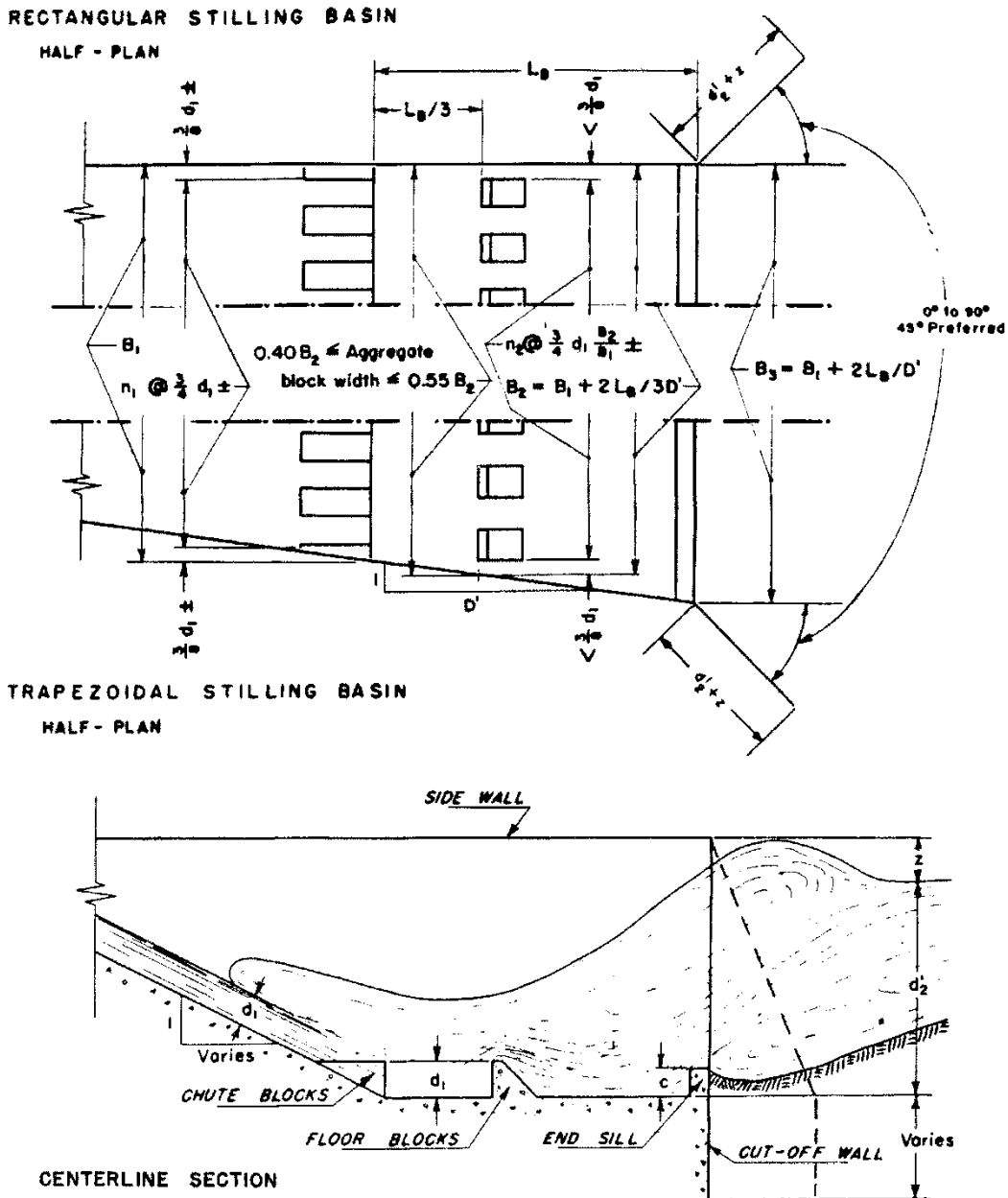

Figure 47.—Proportions and definitions of the SAF stilling basin (Blaisdell, 1959, p. 9). The dimensions are based on the kinetic flow factor. See Blaisdell (1959) for additional discussion of the information shown in this figure.

large spill events, the utilization of a SAF stilling basin as an outlet energy dissipator requires additional downstream protection since it is more likely that the outlet will be subjected to frequent long-lasting flows at a high percentage of the design discharge. Section 9.2.2 describes design guidance for a riprap-lined, preformed scour hole downstream from SAF type basins.

## Chapter 3

# Impact Basins

As the name implies, an impact basin is an impact-type energy dissipator. An impact basin provides a positive barrier within the flow area. Energy dissipation is accomplished through the turbulence created by the loss of momentum as flow entering the basin impacts a baffle, and the direction of the flow is changed. At high flow, further dissipation is produced as water builds up behind the baffle to form a highly turbulent backwater zone. Flow is then redirected under the baffle to the open basin and out to the receiving channel. A sill at the basin end reduces exit velocities by breaking up the flow across the basin floor and improving the stilling action at low to moderate flow rates.

### 3.1 Type VI Impact Basins

Reclamation has developed a type VI impact basin (also known as a baffled outlet, an impact dissipator, or a hanging baffle) that is widely recognized because it does not require any tailwater in order to function properly. Flow striking the vertical hanging baffle initiates energy dissipation in a type VI impact basin. The horizontal portion of the baffle and the basin invert help create a highly turbulent zone upstream of the vertical baffle for additional energy dissipation. This type of basin has an established operational history, and design guidance based on model studies exists as early as 1955 from Reclamation (1955; 1978a; 1978b; 1984; 1987) and others (USACE, 1990; Hager, 1999; Baston, 2000; CDOT, 2004; FHWA, 2006; UDFCD, 2008). Figures 48 and 49 show common applications for type VI impact basins.

The type VI impact basin is a relatively small structure with highly efficient energy dissipation characteristics without tailwater control. The type VI impact basin operates for maximum entrance conditions up to 50 ft/s flow velocity and Froude numbers less than 10.0. The design of the impact basin is limited to a maximum velocity of 50 ft/s to prevent the possibility of damage from cavitation or impact damage to the basin. The impact basin is not practical for flow having a Froude number less than 1.1. The impact basin shown on figure 50 has proved effective for discharges up to about 400 ft<sup>3</sup>/s; for larger discharges, multiple basins could be placed side by side (figure 51).



Figure 48.—Type VI impact basin with no flow being discharged.



Figure 49.—Type VI impact basin with flow being discharged.

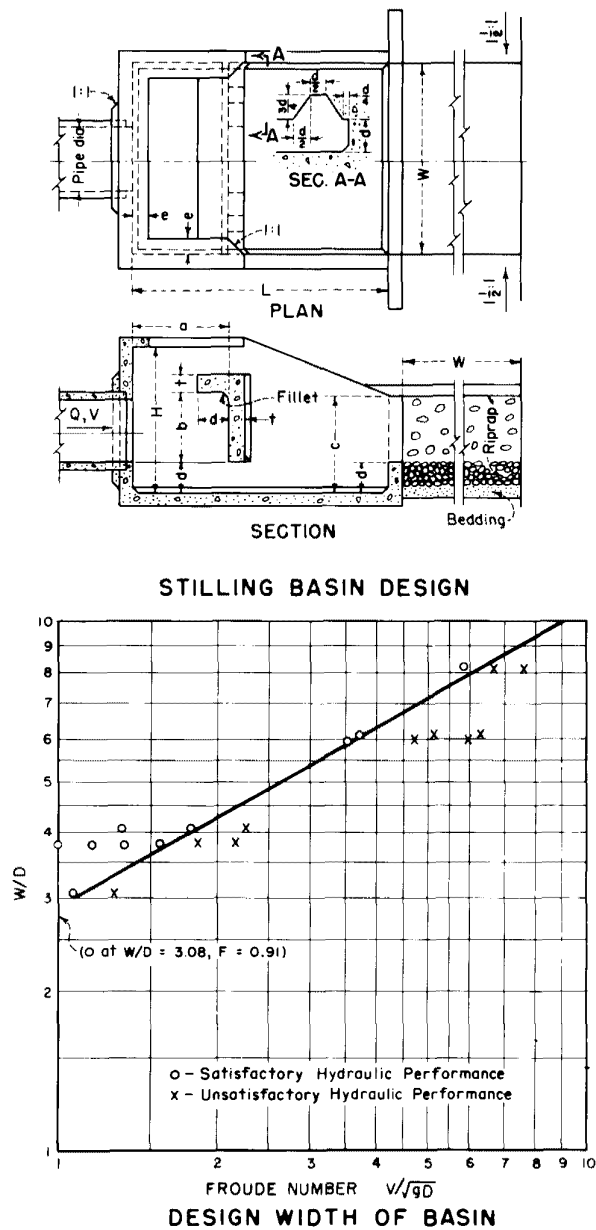

Figure 50.—Dimensional criteria for a type VI stilling basin (Reclamation, 1987, p. 464). See Reclamation (1987) for information related to the variables as denoted in this figure.



Figure 51.—Type VI impact basins placed side by side.

The impact basin is a boxlike structure having a vertical hanging baffle and an end sill. Tailwater is not required for satisfactory hydraulic performance; although a smoother outlet water surface will sometimes result if there is tailwater. The best hydraulic action is obtained when the tailwater height approaches, but does not exceed, half the height of the baffle. The height of the tailwater should not exceed the top of the baffle to avoid some of the flow not striking the baffle. The invert of the impact basin is located below the downstream channel invert if there is no tailwater or if the tailwater is uncontrolled. For proper performance, the bottom of the baffle should be placed at the same level as the invert of the upstream conduit. The impact basin, if properly designed, is a more effective energy dissipator than the hydraulic jump.

The impact basin consists of an open concrete box attached directly to the conduit outlet. The general arrangement of the impact basin and the dimensional requirements, including riprap, are shown on [figure 50](#) and are based on the width,  $W$ , of the structure. The width of the structure is determined according to [figure 50](#) as a function of the Froude number. The impact basin was developed using hydraulic model studies conducted by Reclamation from which detailed dimensions were determined for various Froude numbers.

For a given design discharge ( $Q$ ) and head ( $h$ ), the width of the impact basin is determined by first computing the theoretical velocity ( $V$ ) using [equation 7](#). The head is typically computed as the difference between the upstream water surface and centerline of the conduit into the impact basin. The head represents the amount of



energy to be dissipated. If friction losses are large in the upstream conduit, they should be considered in the determination of the head.

$$V = (2gb)^{0.5} \quad \text{eq. 7}$$

where,

$$\begin{aligned} V &= \text{theoretical velocity (ft/s)} \\ g &= \text{acceleration of gravity} = 32.2 \text{ ft/s}^2 \\ b &= \text{head (ft)} \end{aligned}$$

To standardize the method of computing Froude numbers, the shape of the jet from the conduit is assumed to be square; thus, the theoretical depth of the incoming flow ( $d$ , but shown as  $D$  in [figure 50](#)) is considered to be the square root of the design hydraulic cross-sectional area ( $A$ ). The cross-sectional area ( $A$ ) is computed by dividing the design discharge ( $Q$ ) by the theoretical velocity ( $V$ ). The Froude number ( $F$ ) is then computed using equation 8.

$$F = V/(gd)^{0.5} \quad \text{eq. 8}$$

where,

$$\begin{aligned} F &= \text{Froude number} \\ V &= \text{theoretical velocity (ft/s)} \\ g &= \text{acceleration of gravity (32.2 ft/s}^2\text{)} \\ d &= \text{theoretical depth of incoming flow (ft)} \end{aligned}$$

If the Froude number is more than 10, use of this type of impact basin is not practical. The minimum required width ( $W$ ) of the impact basin for the computed Froude number is determined using [figure 50](#). The remaining dimensions of the impact basin are based on this minimum required width, as shown in [figure 50](#). For best results, the impact basin should be equal to or slightly greater than the minimum required width indicated on [figure 50](#). However, if the basin is too large, the incoming jet will spread and pass under the baffle, and effective energy dissipation will not occur. The impact basin can be larger than needed for less than the design discharge, but should not be undersized for the design discharge.

The height of the baffle should not be less than the diameter of the incoming conduit to prevent the jet from passing over the baffle. The incoming conduit should be vertically aligned with the overhanging baffle such that the conduit invert is not lower than the bottom of the baffle. The end sill height is equal to the height under the baffle to produce tailwater in the basin.

Sediment may accumulate in the impact basin upstream of and below the hanging baffle during periods of nonuse. Cleanout notches may be installed in the baffle to provide openings for two concentrated jets to begin erosion and removal of the sediment from the basin. If the invert of the impact basin is full of sediment, the

basin still has the capability of satisfactorily discharging the dissipated design discharge over the top of the baffle. If it is determined that the basin beneath the baffle will remain relatively free of sediment during normal operation, the notches may be omitted.

The side walls are designed to be high enough to contain most of the splashing during high flows and sloped to form a transition to the downstream outlet channel. Excessive splash overtopping the side walls upstream of the baffle, usually resulting from too small a basin for the quantity and velocity of flow involved, can erode the fill outside of the side walls. Open grating installed along the top of the sidewalls helps to prevent unauthorized entry into the basin.

Riprap and bedding should be provided along the bottom and sides downstream of the impact basin to prevent scouring of the outlet channel, especially when little or no tailwater exists. Channel erosion will occur if the size of riprap is not adequate. The riprap should be placed to a depth equal to the height of the end sill for a distance equivalent to one basin width downstream from the end sill, as shown in [figure 50](#).

Downstream wingwalls placed at 45 degrees from the direction of the flow along with a longer end sill may also be effective in reducing scouring and flow concentrations downstream. The longer end sill would allow the flow to spread more uniformly over a wider channel and reduce erosion tendencies and wave heights.

The impact basin is subjected to large dynamic forces and turbulence, which must be considered in the structural design. The structure must be made stable enough to resist sliding caused by the impact load on the baffle wall. The entire structure must also resist the severe vibrations inherent with this type of device, and the individual structural members must be strong enough to withstand the large dynamic loads; therefore, when possible, found the basin on firm rock.

Specific design guidance is available from several agencies. Reclamation provides design graphs, in terms of discharge and recommended basin widths ([Reclamation, 1955, p. 6; 1978a, p. 13; 1984, p. 83; 1987, p. 464](#)). An example graph is shown in [figure 52](#). The Federal Highway Administration (FHWA) has published a design curve for type VI basins as shown in [figure 53](#). The Colorado Department of Transportation has a design checklist available in chapter 11 of its *Drainage Design Manual* (CDOT, 2004, pp. 11–14).

The graph in [figure 52](#) has two parallel lines, which show, for a given basin width ( $W$ ), the range of discharges over which best operation is obtained. These lines are

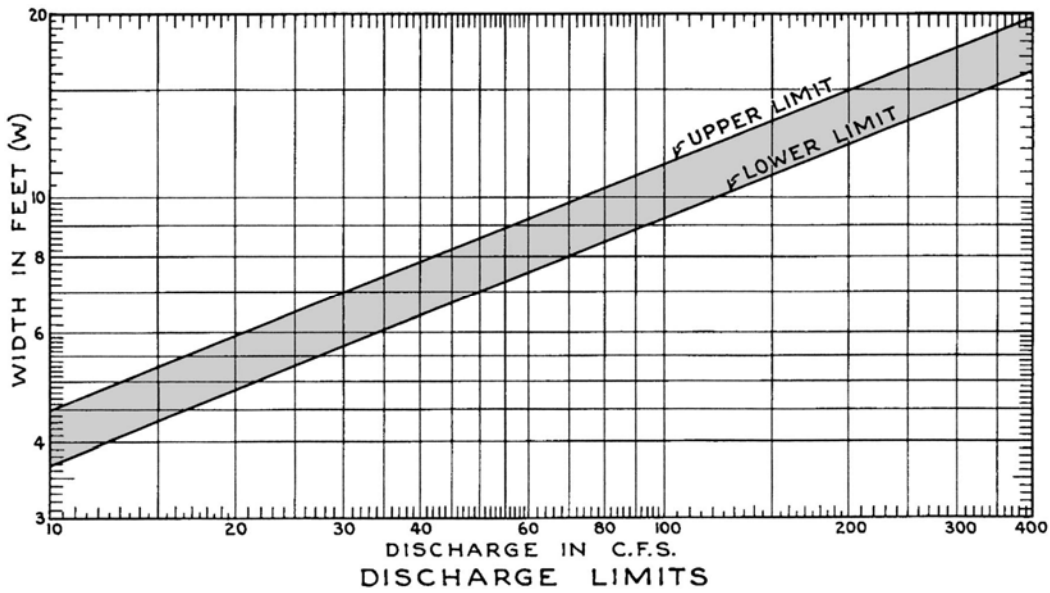

Figure 52.—Reclamation design aid for type VI impact basins (Reclamation, 1984, p. 83).

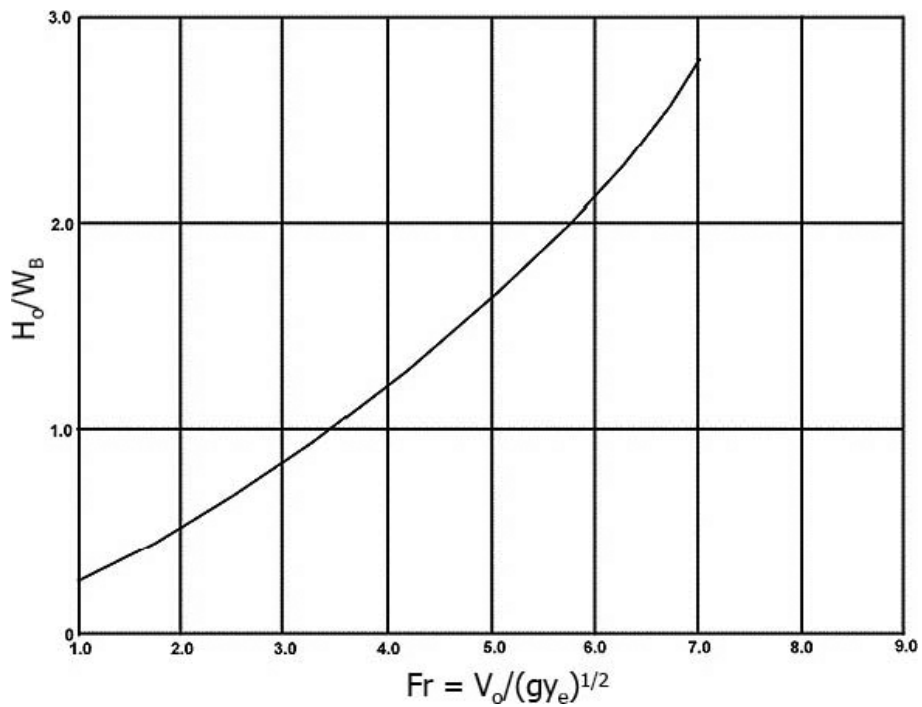

Figure 53.—Federal Highway Administration design curve for type VI impact basins (FHWA, 2006, p. 9-36). See FHWA (2006) for information related to the variables as denoted in this figure.



## Outlet Works Energy Dissipators

---

simply the scaling ratio. The discharge given by the lower limit line should not be exceeded appreciably because improper operation will result. This line is given by:

$$W = 1.47Q^{0.4} \quad \text{eq. 9}$$

where,

$W$  = width of basin (ft)

$Q$  = discharge (ft<sup>3</sup>/s)

The upper limit line may be exceeded, but represents the point at which no appreciable improvement in performance results from a larger basin for a given discharge. This line is given by:

$$W = 1.79Q^{0.4} \quad \text{eq. 10}$$

where,

$W$  = width of basin (ft)

$Q$  = discharge (ft<sup>3</sup>/s)

If the entrance velocity approaches 30 ft/s and the basin is expected to operate in the upper discharge limit range, the lower limit line should be used to obtain the basin width. Other basin dimensions should be enlarged proportionally ([Reclamation, 1955, p. 2](#)).

Not following established guidance can affect system hydraulics resulting in reduced discharge, unstable or pulsating flow, and splashing (figure 54).



**Figure 54.**—The end of this outlet conduit was constructed too close to the vertical hanging baffle resulting in intense sprayback.

The [Ganado Dam case history](#) in appendix A discusses the design and construction of a type VI impact basin.

### 3.2 Streambed-Level Basins

Simple streambed-level basins have been used by some state departments of transportation for energy dissipation of flow exiting highway culverts. These basins are typically designed to operate at the stream level and reestablish natural flow conditions downstream from the culvert outlet. They typically utilize an obstacle in the flow path that forces a hydraulic jump. They are intended to be low cost and drain by gravity when not in operation.

This section will briefly present a few types of streambed-level basins. However, none of these types of basins should be used at significant and high hazard potential dams due to their limited applicability for energy dissipation and lack of operational history in conjunction with outlet works systems. They should only be considered for use at small, low hazard potential dams where the risks due to misoperation or failure are deemed to be acceptable. Wherever these basins are considered for use, the designer must have a good understanding of the Froude number, tailwater conditions, basin limitations, and downstream conditions.

#### 3.2.1 Hook basin

The hook basin ([figure 55](#)) was developed at the University of California in cooperation with the California Division of Highways and the Bureau of Public Roads ([MacDonald, 1967](#)). The basin was originally developed for large arch culverts with low tailwater, but can be used with box or circular conduits. The energy in a hook basin is dissipated by the hooks reversing and turning the momentum of flow upon the surrounding flow to rapidly widen the flow and slow the overall velocity.

A hook basin can be designed with a constant cross section in the basin, or the floor can be flared slightly outward in the downstream direction. Depending on exit velocity and soil conditions, some scour can be expected downstream of the basin. The designer should, where necessary, provide channel armament protection in this area ([FHWA, 2006, p. 9-20](#)). Where large debris is expected, the upstream face of the hooks should be armored with steel ([Baston, 2000, p. 45](#)).

The FHWA provides design guidance for hook basins in their publication, *Hydraulic Design of Energy Dissipators for Culverts and Channels* (2006).



Figure 55.—Hook basin.

### 3.2.2 Standard baffle basin

Design development for standard baffle basins is limited, although they have been successfully used in West Virginia for different conduit applications. [Figure 56](#) shows an example of a standard baffle basin. Most of the dimensions of the basin are functions of the conduit diameter.

Material has the potential to collect downstream of the center baffle. Observed conditions after operation at some of the West Virginia facilities indicate a potential “dead zone” in this area where flows may not adequately reach and a zone of debris could accumulate ([Baston, 2000](#); [Eli, 2002](#)). A failure of this type of dissipator occurs when enough debris and/or sediment builds up around the baffles and the downstream area such that the conduit is unable to flow at full capacity. For an outlet works conduit, the likelihood of this situation is less because the upstream end of the conduit does not typically let appreciable quantities of debris or sediment enter. If such plugging did occur, the capacity of the outlet works would likely be reduced or eliminated, depending on the severity ([Baston, 2000](#)).

Due to the configuration of the basin, vertical spray from impact of the flows against the center baffle could be an issue, particularly in cold weather when ice buildup could quickly become problematic. In this case, a hood could be installed over the basin to prevent overspray.



Figure 56.—A standard baffle basin.

The [West Virginia Department of Highways \(WVDOH\) Report No. 142 \(2002\)](#) and [Baston \(2000\)](#) provide design guidance for the standard baffle dissipator.

### 3.2.3 Colorado State University rigid boundary basin

The Colorado State University (CSU) rigid boundary basin uses staggered rows of baffles to initiate a hydraulic jump. CSU tested a number of basins with different roughness configurations to determine the average drag coefficient over the roughened portion of the basins. The effects of the baffles are reflected in a drag coefficient that was derived empirically for each roughness configuration ([FHWA, 2006, p. 9-2](#)).

The CSU test results indicate several design limitations with this type of basin. The height of the baffles and the relative spacing between rows of baffles is restricted. Riprap may be needed for a short distance downstream of the basin.

The FHWA provides design guidance for the rigid boundary basin in their publication, [Hydraulic Design of Energy Dissipators for Culverts and Channels \(2006\)](#).

[Figure 57](#) shows a basin with staggered rows of baffles.





Figure 57.—Basin utilizing staggered rows of baffles.

## Chapter 4

### Plunge Basins

When the erosion anticipated downstream of the outlet works is minimal and/or manageable, a plunge basin (pool) is commonly used as the energy dissipator. A plunge basin is a deep pool energy dissipator into which a free jet of water can fall. The natural shape of a plunge basin is elliptical with the greater length parallel to the jet-flow. The plunge basin may be preexcavated with the shape purposely designed and constructed and may be lined with scour-resistant materials such as riprap and/or concrete. Alternatively, the plunge basin may be unlined and allowed to scour as a result of the hydraulic action of the free falling jet.

Plunge basins are commonly used with cantilevered outlet pipes that are either gated or free flowing. The erosion of the downstream channel that the plunging jet of water is released into can be estimated based on the amount of water released and the point of impact. The depth and extent of a plunge basin depend upon a number of hydraulic parameters including the outlet area, the anticipated range of discharges and outlet velocities, the distance between the outlet invert and tailwater (height of fall or drop), and depth of the tailwater. A plunge basin is typically sized to minimize scour of the bed material. A properly designed plunge basin would be very similar in size and shape to the scour hole that would develop for that foundation. Placement of the deepest scour point in the middle of the basin with the length and width centered about it yields a satisfactory design for a single discharge condition. Final designs of larger structures may require individual hydraulic model studies to determine the optimum plunge basin dimensions. The [Seven Oaks Dam case history](#) in the appendix is an example of a preexcavated plunge basin.

Plunge basins are also used in combination with flip buckets. Flip buckets are used to project the flow downstream from the end of the structure. In this case, the jet from a flip bucket spreads across the width of the structure. Increasing the area over which the jet enters the plunge basin decreases the energy per unit area of the inflow jet. During the development of an unlined plunge basin, the plunging jet moves soil and/or debris, creating a mound of this material downstream of the plunge basin, potentially raising the tailwater significantly and drowning out the flip bucket. Therefore, many plunge basins are excavated and shaped to alleviate this potential problem. The [Lucky Peak case history](#) in the appendix discusses a design issue with a flip bucket design for an outlet works.

### 4.1 Types of Plunge Basins

Plunge basin energy dissipators may be unlined or lined. Unlined plunge basins are allowed to develop as a result of the hydraulic action of the free falling jet. The foundation, hydraulic parameters, and the distance from the invert of the jet to the tailwater are considered in estimating the anticipated erosion and the ultimate shape (depth and length) of the scour hole; thereby allowing the shape to be preconstructed. Leaving the plunge basin unlined (figure 58) allows the hole to scour more if the energy in the flow can still erode the bed materials or if the shape and size of the plunge basin is underdesigned. Plunge basins may also be lined with scour-resistant materials such as riprap (figure 59) or concrete (figure 60). Dimensions of the anticipated scour hole may be reduced when lined with protective materials. The lining materials should be sized so that no foundation materials in the basin are eroded or removed from the basin by the turbulence of the jet entering the plunge basin. Excessive erosion of foundation materials could result in the objectionable formation of bars of riverbed material, which may temporarily raise the tailwater and impair operations.

The [Elkhead Creek Dam](#) and [Standley Lake Dam case histories](#) in the appendix discuss lined plunge basin applications.



Figure 58.—Unlined plunge basin (view is looking downstream). This basin has been allowed to scour over time.





Figure 59.—A riprap-lined plunge basin.



Figure 60.—Concrete-lined plunge basin with baffle wall, grouted riprap side slopes, and discharge channel. Flow discharges into the plunge basin from two 36-inch diameter fixed-cone valves.

## 4.2 Jet Trajectory

The trajectory of the discharge jet into a plunge basin can determine the location of the plunge basin. The jet trajectory, velocity, and angle of impingement with the basin surface can indicate the shape and size of a plunge basin. [Figure 61](#) shows an



Figure 61.—Jet trajectory from a 54-inch diameter hooded fixed-cone valve.

example of a jet emerging from an outlet works. Model studies reported by [Johnson \(1974\)](#) have indicated that when the angle of impingement is less than 25 degrees above the horizontal, the jet does not enter the basin but, instead, skips across the surface. If the jet skips over the surface of the basin, surface waves and eddies can develop, with sufficient energy to erode the side slopes of the basin due to high exit velocities.

A jet freely falling into a plunge basin has both horizontal and vertical velocity components. These velocity components play a role in the dimensions of the plunge basin. [Blaisdell and Anderson \(1989\)](#) provide details of the jet trajectory and the horizontal and vertical velocity components as they relate to the design of plunge basins for cantilever pipe outlets.

### 4.3 Plunge Basin Scour Process

Scour is the removal of material by water. Scour can occur when a jet of water impinges upon an unprotected surface. During the scour process, the scour hole becomes more defined and larger as more material is removed. The horizontal velocity component of the jet released from the outlet has the ability to carry soil and/or debris away from the developing scour hole. As the depth of the scour hole progresses, material is suspended in the water in the bottom of the hole. Flow from the hole removes some of the suspended material, but other material is recirculated

in suspension. The amount of scour decreases as the size of the scour hole increases.

The trajectory of the discharge jet into a plunge basin contributes to the determination of the location, shape, and size of a plunge basin. When a jet plunges into a basin, diffusion and depth affect its erosive capacity. A deeper basin has a lower jet velocity at the bottom of the basin, thereby reducing the ability to scour. Completely stable basins are scour-resistant disabling further removal of soil/rock from the scour hole. The ultimate maximum depth of scour represents a completely stable plunge basin and is a design consideration for determining the depth of the plunge basin. The excavated depth of a plunge basin is not always the estimated depth of scour.

#### 4.4 Plunge Basin Design

The depth to which a falling jet scours a plunge basin is related to the range of discharges, the height of the fall, and the depth of tailwater (Reclamation, 1987). The streambed scours as a result of the abrading action of the churning water and sediment in the basin unless it is stabilized with scour-resistant materials such as riprap or concrete. Ultimately, the scour in an unlined plunge basin will reach a limiting depth as the energy of jet is no longer able to remove stream bed material from the scour hole. This depth of scour depends on the erodibility of the material in the plunge basin or the gradation of the armoring material in the basin. The ultimate depth of scour is often used when determining the dimensions of the plunge basin. A simple empirical approximation of the ultimate scour depth for a free jet falling vertically into a pool (Reclamation, 1987) is:

$$D = 1.32H^{0.225}q^{0.54} \quad \text{eq. 11}$$

where,

$D$  = ultimate scour depth below tailwater level (ft)

$H$  = elevation difference between the reservoir and tailwater (ft)

$q$  = unit discharge  $\text{ft}^3/\text{s}$  per foot width

Equation 11 does not take into account the size of the bed material or the tailwater. Wittler, et al. (1998) describe other plunge basin scour depth relationships, one of which takes into account such parameters.

When a jet issues from a conduit horizontally, a trapezoidal plunge pool may be used. Such a basin should be used only where the jet discharges into the air and then plunges downward into the basin.



Blaisdell and Anderson (1989, pp. 152–153) determined the ultimate scour depth downstream of a cantilever pipe outlet based on a densimetric Froude number and pipe diameter. The densimetric Froude number is used to measure the ability of the jet to mobilize the bed material. As this Froude number increases, the scour depth of the plunge basin also increases.

Blaisdell and Anderson (1989) provide design guidance for determining the size, shape, location, and riprap size for a plunge basin energy dissipator for cantilever pipe outlets based on model studies. This guidance has been summarized in the Natural Resources Conservation Service's (NRCS) (formerly the Soil Conservation Service whose name was changed in 1994) *Riprap-Lined Plunge Pool for Cantilever Outlet, Design Note 6* (1986). A cantilevered pipe outlet is a horizontal or nearly horizontal pipe outlet that is either gated or free flow. The design guidance, as outlined by Blaisdell and Anderson (1989), apply to pipe outlets located above the tailwater so the horizontal jet falls into the plunge basin and turbulent mixing and drag on the boundaries dissipates the energy (Rice and Kadavy, 1994, p. 1167). The successful operation of a plunge basin at a cantilever pipe outlet with free outlet conditions results in negligible kinetic energy in the outflow at the basin outlet, no erosion or loss of the plunge basin foundation soil due to the turbulence in the process of energy dissipation, and no displacement of the riprap in the plunge basin.

For plunge basin design, outlet conditions are defined as either free flowing outlet (unsubmerged) or submerged. Definition of these conditions is based on the pipe diameter distance from the tailwater and is important because these conditions dictate which design procedures to apply. The definition of the outlet conditions are:

- Condition 1: Free outlet condition with the pipe invert of greater than one pipe diameter ( $D_o$ ) from the tail water surface (Blaisdell and Anderson, 1989, pp. 76-79; NRCS, 1986).
- Condition 2: Free outlet condition with pipe invert less than or equal to  $D_o$  from tailwater surface to submergence of  $0.7D_o$  below tailwater surface (Rice and Kadavy, 1995, pp. 1405-1411).
- Condition 3: Submerged outlet at  $0.7D_o$  below tailwater surface to maximum of  $D_o$  below the tailwater surface (Rice and Kadavy, 1994, pp. 1167-1173).

Rice and Kadavy (1994) completed model studies that determine the riprap size, and the size, shape, and location of plunge basins for submerged cantilever pipe outlets. Under submerged conditions, the jet tends to float and remains intact some distance downstream until it reaches a point where the jet becomes fully turbulent (Rice and Kadavy, 1994, p. 1167). The dimensioning of the plunge basin and the sizing of the energy-dissipating materials differ from when the plunge basin is designed under free

flow conditions (Rice and Kadavy, 1994, p. 1172). Additional guidance on riprap design can be found in Fletcher and Grace (1972).

Reclamation (1987) and Design Note 6 (NRCS, 1986) indicate that the bed material size can control the depth of erosion or ultimate scour depth created by the discharging jet of water. Blaisdell and Anderson conducted their research tests on noncohesive materials, and they indicated that the plunge basin depth guidance presented in Design Note 6 is appropriate for soil and riprap bed material that perform as a single grain material in resisting erosion. If the erosion depth is to be adjusted, it is suggested that the  $D_{50}$  size for the riprap material may be varied. Additionally, model studies that Blaisdell and Anderson performed indicate that a nonerodible layer had minimal effect on the overall shape of the plunge basin above that layer. Design Note 6 also provides guidance in assuring that the  $D_{50}$  bed material size is adequate for controlling shallow beach type erosion at the top edge of the plunge basin.

According to Blaisdell and Anderson (1989), plunge basin dimensions are developed using a dimensionless discharge parameter that takes into account design discharge, pipe diameter, and gravitational acceleration. Johnson (1974) indicates that there are maximum values for each of the three primary dimensions (length, width, and depth) for a given angle at which the jet impinges. The maximizing angle of impingement for the plunge basin depth is approximately 45 degrees, and the maximizing angle of impingement for the width and length of a plunge basin is 35 degrees. When the tailwater depth is greater than one-fourth of the total energy head, the maximizing angle becomes steeper as the ratio of the total energy head to the tailwater depth is reduced.

The method for determining scour depth for plunge basins as described by Reclamation (1987) is more appropriate for noncohesive bed materials. The methods for determining scour depth for plunge basins described in Design Note 6 (NRCS, 1986) is more appropriate for soil and riprap bed material that perform as a single grain material in resisting erosion. Some limited research has been conducted in determining plunge basin dimensions in bedrock material. Wittler, et al. (1998) describe a method that estimates the erosion threshold for earth materials ranging from sand to rock. This technology is based on an erodibility index method that bases the extent of the erosion on an erodibility index and stream power. Additional research is needed for plunge basins constructed from cohesive foundation materials such as bedrock to consider joint sets, continuity of joints, and/or material properties.

No d criteria exist for plunge basins that will provide satisfactory dissipation for all heads, discharges, and incoming jet conditions (i.e., jets created by flip buckets). Several small outlet works plunge basins that have operated satisfactorily were used to approximate the basin geometry shown in figure 62. The basin depths were about one-fifth of the difference in elevation between maximum reservoir water surfaces

and maximum tailwater levels. The minimum bottom widths were the width of the incoming jet or the width required to limit the average velocity at the downstream end of the basin to about 3 ft/s, whichever was greater. Section 9.1.2 provides additional guidance for riprap basin design within a horizontal conduit exit.

The [Seven Oaks Dam case history](#) in the appendix discusses plunge basin design.

#### 4.5 Flip Bucket

A flip bucket is sometimes used at the end of an outlet works to deflect the discharge away from the toe of the dam (where the river bed damage which usually would certainly occur does not endanger the safety of the dam or other structures including the flip bucket itself). The flip bucket is a relatively short structure often used in conjunction with plunge pools. The flip bucket should not be confused with the similar “roller bucket.” The roller bucket is a submerged dissipator that requires well

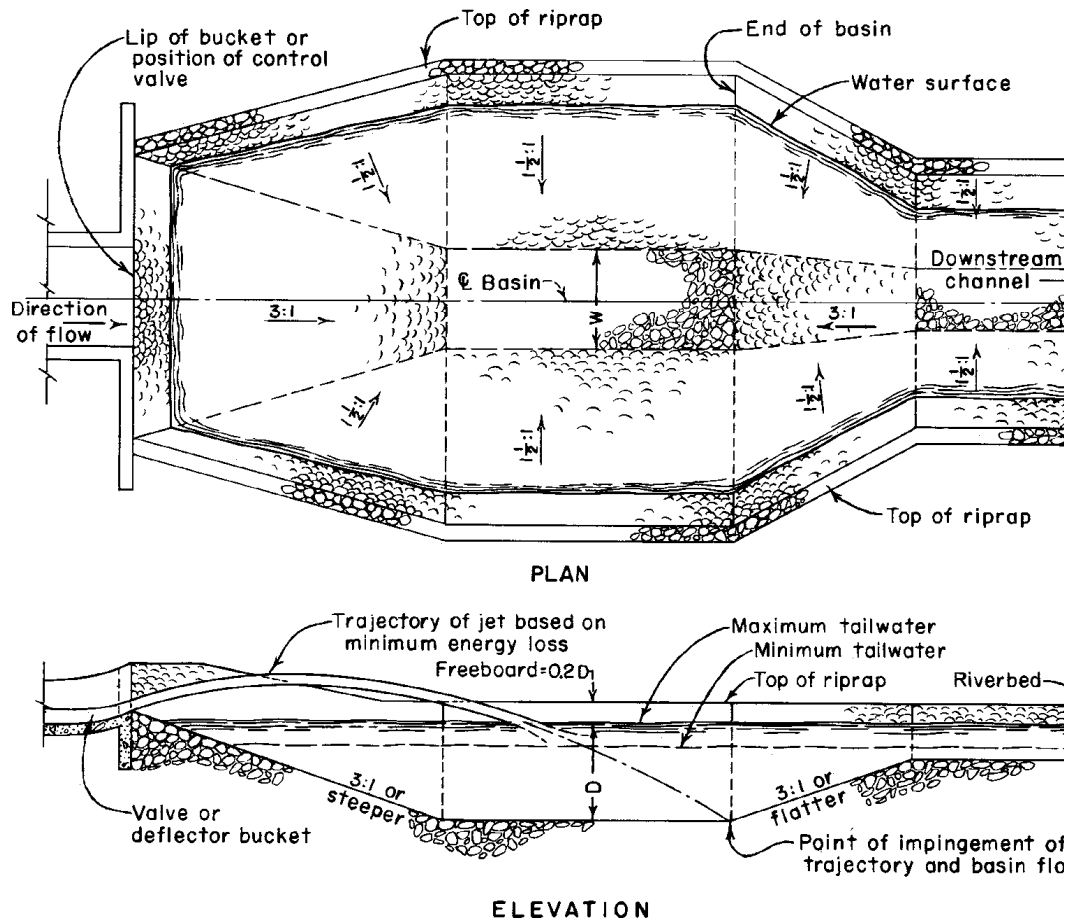

Figure 62.—Typical lined plunge basin design (Reclamation, 1987, p. 403). See Reclamation (1987) for information related to the variables as denoted in this figure.

defined tailwater conditions and provides for energy dissipation in the immediate vicinity of the bucket, whereas the flip bucket is located above the tailwater and deflects the water downstream for some distance into a plunge pool. Dentates are frequently used to spread the compact jet as it enters the plunge pool. The literature frequently refers to the energy dissipation effects of the jet within the air due to the spreading jet and distance traveled. Flip buckets are not a substitute for energy dissipators because such buckets are inherently incapable of dissipating energy within themselves. The principle effect of the dentates is to increase the area over which the jet enters the plunge pool. This decreases the energy per unit area and the area over which the energy is dissipated. High velocity flow passing over the sharp edges may produce damage from cavitation on the concrete surfaces.

Flip buckets should be self-draining to prevent water from being backed up into the outlet works conduit. The installation of a drain placed on the surface should be avoided since this would be exposed to high velocity flow resulting in cavitation pressures. Additional guidance on flip bucket design is available in [Reclamation's Engineering Monograph No. 25 \(1984\)](#).





## Chapter 5

# Stilling Wells

A stilling well is an alternative method to provide energy dissipation at the conduit outlet to prevent erosion within the downstream channel. Energy dissipation within the stilling well occurs by expansion as flow exits the conduit and enters the enlarged chamber of the stilling well, by the impact of flow on the chamber base and walls, and by the momentum loss resulting from the redirection of flow. Stilling wells require the flow to travel vertically upward to exit the well and reach the downstream channel. This chapter discusses two types of stilling wells with distinctly different applications.

### 5.1 High Head Application

A Reclamation vertical stilling well ([figure 63](#)) is designed to provide economical energy dissipation in association with a bottom discharge sleeve valve. This type of structure allows for measured flow releases for irrigation, municipal, and industrial water users. For discussion of ported sleeve valves and V-ported sleeve valves, see [chapter 7](#).

Prototypes are installed at numerous Reclamation dams. These installations included sleeve valve diameters between 12 and 24 inches, design flow rates from 10 to 70 ft<sup>3</sup>/s, with maximum static heads from 70 to over 200 feet. Inspection evaluations indicate most have not experienced damage, although some instances of stilling well erosion have been noted ([Reclamation, 1973, table IV, p. 26](#)).

A vertical stilling well is well suited to dissipate energy for flow exiting a high energy jet that occurs with a high head installation. In the typical application, the high velocity jet exits the valve and rises vertically in the chamber prior to discharging into the exit channel. The development of the sleeve valve by Reclamation greatly improved the performance of the vertical stilling well; see [section 7.2](#).

The advantages of the vertical stilling well include:

- Minimal requirement for water levels within the downstream channel.

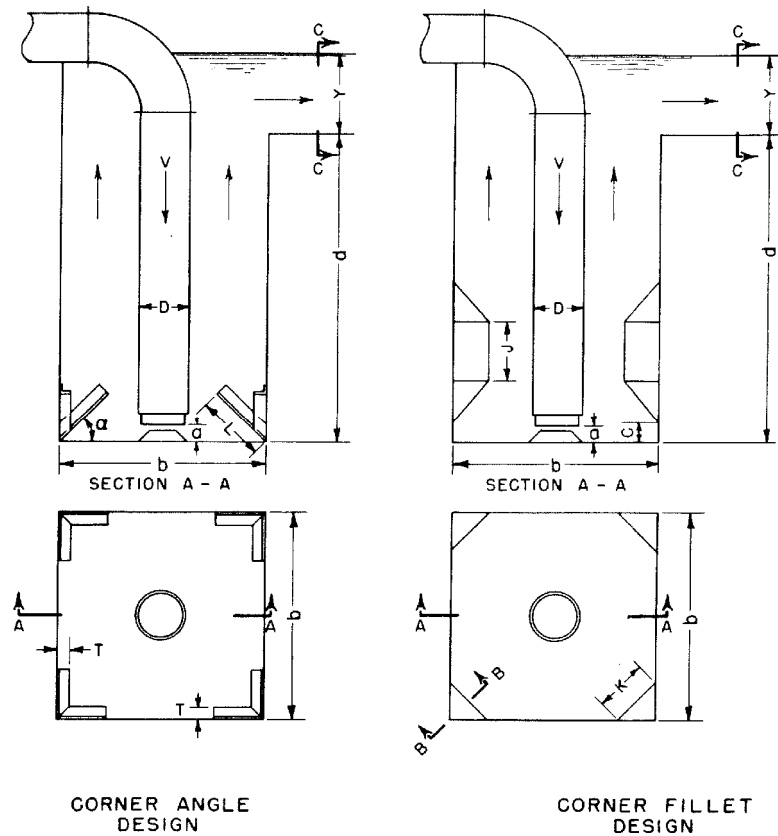

Figure 63.—Typical Reclamation stilling well application. The corner fillets and pedestal in the invert tend to maximize the circulation and energy dissipation in the lower portion of the well (Reclamation, 1973, p. 29). See Reclamation (1973) for information related to the variables as denoted in this figure.

- Adaptable to sites with limited space due to other infrastructure restrictions.
- Inclusion of a sleeve valve may allow for more economy of savings than other alternatives.

The disadvantages of the vertical stilling well include:

- Requires a steel liner to reduce the potential for damage to the pedestal and lower portion of the chamber. In some cases, the anchorage for the steel liner has been determined to be underdesigned for the conditions actually experienced.
- Problems have been experienced with the valve operating mechanism due to turbulence in the stilling well.
- The typical valve and stilling well application is not well suited for use with high debris loads.

The [Palm Tree Creek Outlet case history](#) in the appendix discusses a stilling well design.

### 5.1.1 Design considerations

The design of this type of stilling well energy dissipator is based on physical model tests conducted by Reclamation covering a range of heads and discharges. A typical Reclamation stilling well with a valve is illustrated in [figure 63](#). [Figure 64](#) shows an example installation.

The design criteria apply to vertical stilling wells with a standard sleeve valve placed on the floor. Design limits include the maximum sleeve travel equal to one-half the pipe diameter. The design is also based on the downstream channel flow depth equal to one half the stilling well width to optimize energy dissipation and maintain the desired wave height ([Reclamation, 1973, p. 24](#)).

The design guidance included in the following sections assumes a ratio of stilling well depth ( $d$ ) to width ( $b$ ) of 1.5. In some instances, a design based on other  $d/b$  ratios might be more economical (design curves for 1.0 and 2.0 are also available ([Reclamation, 1973](#))). In general, the  $d/b$  ratio of 1.5 should be the appropriate choice.

The physical model study report states that while the corner angle configuration has not been field tested, the model study indicated a smoother tailwater surface than that produced by the corner fillet, and the corner angle is a more economical design ([Reclamation, 1973, p. 24](#)).

The [Agate Dam case history](#) in the appendix discusses the use of a stilling well containing a sleeve valve.

### 5.1.2 Design guidance

The design flow, valve diameter, and allowable wave height are used to determine the well width-to-depth ratio. Additional design details such as the corner configuration geometry may also be determined ([Reclamation, 1973, p. 27](#)).

Design guidelines suggest lining the stilling well with 1/2-inch stainless steel and the walls to a height of  $1.5D$  with 1/2-inch carbon steel. Welding the corner geometry steel to the liner is also recommended.

The design is based on the downstream channel flow depth equal to one half of the stilling well width ( $b$ ). If the channel has a flow depth greater or less than  $1/2b$ , the well depth ( $d$ ) should be adjusted to maintain the total submergence. Judgment must be used in designing stilling wells that discharge into channels with depths different from those used in the physical model tests. In most cases, minor adjustments of the

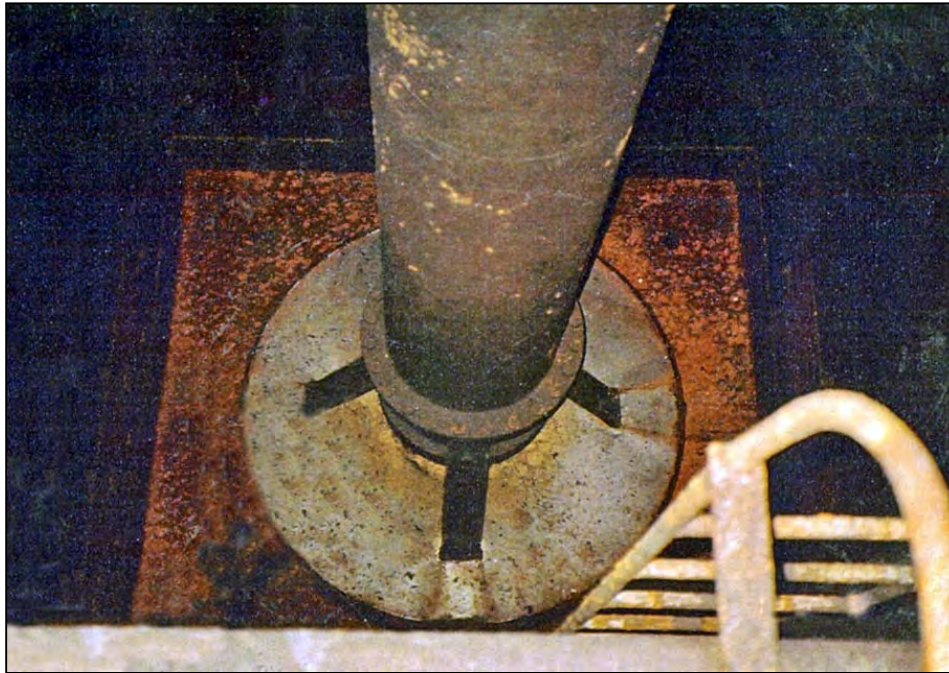

**Figure 64.**—This stilling well was installed in 1966 and consists of a 10-foot wide well, 16-foot depth, and a 24-inch diameter sleeve valve. Design discharge is 78 ft<sup>3</sup>/s at a static head of 88 feet.

well depth can be made without affecting the efficiency of the stilling well as an energy dissipator or the predicted wave heights in the downstream channel ([Reclamation, 1973, p. 30](#)). Inclusion of rock riprap within the downstream channel for two to four channel widths may also be warranted.

### 5.1.3 Other considerations

Design applications that exceed the stated limits are not recommended. Designer judgment is required when selecting the design flow and downstream tailwater conditions. Consideration should be given to normal tailwater variability when selecting the final design.

Physical model investigations examined pressure distribution within the stilling well and possible damage from cavitation. The steel lining recommendations are a result of the pressure investigations and previous prototype experience.

The physical model was based on standard sleeve valve investigations where the flow leaving the valve spreads radially from the top of a pedestal. In addition, tests were performed to evaluate flow characteristics of a ported sleeve valve. In general, the port configurations that yielded the lowest impact pressure on the wall were those that had a small dimension in at least one direction ([Reclamation, 1973, p. 22](#)).

## 5.2 Low Head Application

The USACE low head conduit outlet stilling well (figure 65) is suitable for applications with installation at the exit of smaller sized conduits with low design flows where site geometry limits the application of other types of energy dissipators. This stilling well is ideal for sites that may have highly variable flow levels within the downstream channel. Practical size considerations limit application for high flow rates or energy levels. With many sizes of precast concrete basins available, the stilling well is economical to install. However, the stilling well must be designed for possible vibration and thrust and may require reinforced cast-in-place concrete founded on rock for larger installations.

Energy dissipation at the outlet from low head dams may be accomplished using the model test results and design guidance established for storm drain outlets by the USACE. The typical application of this type of stilling well includes installation at the exit of a smaller sized conduit or open channel that may have highly variable flow levels within the downstream channel (figure 66). The stilling well is easily adapted to fit within limited site constraints that may prevent installation of a traditional open basin. The structure also can accommodate flow entering from more than one source as well as vertical elevation differences.

The advantages of the conduit outlet stilling well include:

- Relatively independent of water levels within the downstream receiving channel.
- Adaptable to sites with limited space due to other infrastructure restrictions.
- May be constructed from prefabricated reinforced concrete.
- The stilling well may receive incoming flow from more than one conduit.

The disadvantages of the conduit outlet stilling well include:

- May be subject to clogging and is not recommended in areas with high debris or large sediments. The stilling well can accommodate light to moderate loads.
- Some combinations of conduit size and design flow may require a stilling well size that is not practical and is limited to low head applications.

### 5.2.1 Design considerations

The design of the low head conduit outlet of stilling well energy dissipator is based on physical model tests conducted by the USACE. The design is relatively simple and requires the size of the incoming pipe and design discharge. Model tests indicate that satisfactory dissipation can be maintained for  $Q/D_o^{5/2}$  ratios as large as 2, 3.5, 5,





Figure 65.—Stilling well a at conduit outlet.

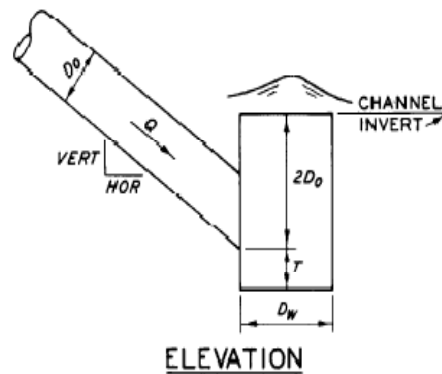

Figure 66.—Typical stilling well at a conduit outlet (USACE, WES, HDC Sheet 722-1, 1973) See section 5.2.1 for information related to the variables as denoted in this figure.

and 10 with stilling well diameter ( $D_w$ ) of one, two, three, and five times that of the incoming conduit diameter (USACE, 1984, p. 20-3). For example, using a 4-foot conduit diameter ( $D_o$ ) with a stilling well diameter ( $D_w$ ) of 20 feet and the  $D_o/D_w$  ratio of 5, the maximum design inflow rate ( $Q$ ) that provides an allowable ratio for energy dissipation is 320 ft<sup>3</sup>/s. However, this maximum may not be practical for all applications because quite large diameter stilling wells can be required. Expanding the preceding example, a stilling well diameter ( $D_w$ ) of 20 feet is required. A series of computations using ratios for satisfactory energy dissipation (USACE, 1984, p. 20-3) that demonstrate the limitations for effective energy dissipation with the USACE stilling well and example applications are summarized in table 3:



Table 3.—Example flow/discharge ratio summary

Satisfactory energy dissipation		Example values that meet criteria		
Maximum ratio $Q/D_o^{5/2}$	$D_o / D_w$	Design flow, $Q$ (ft <sup>3</sup> /s)	Conduit diameter, $D_o$ (ft)	Stilling well diameter, $D_w^*$
≤10	5	320	4	20
≤5	3	75	3	9
≤3.5	2	20	2	4
≤2	1	5	1.5	1.5

\*Note that stilling well diameter ( $D_w$ ) may need to be adjusted to conform with stilling well depth as shown in [figure 66](#) (expanded from [table 20-1, USACE, 1984, pp. 20-10](#)).

General design considerations are available ([FHWA, 1983, section 10-B](#)) and summarized as follows:

- Model tests indicate that an optimum depth of the stilling well below the invert of the incoming conduit can be determined by the slope of the incoming conduit and the stilling well diameter ( $D_w$ ).
- The distance from the conduit invert to the top of the stilling well is set at twice the conduit diameter ( $D_o$ ). The distance provides satisfactory performance and a practical cost. Increasing the distance would provide a larger well and greater energy dissipation.
- Tailwater also increases the energy dissipation of the stilling well. When possible, locating the stilling well outlet to provide additional tailwater should be considered.
- Design criteria recommend the use of rock riprap around the stilling well outlet and in the downstream exit channel.
- The stilling well outlet may also be covered with a screen or safety grate. The grate open area should be at least 75 percent of the total stilling well area and capable of passing small floating debris to minimize grate turbulence and clogging potential.

The designer should be aware of the following concerns when designing a stilling well:

- A hydraulic jump can occur in the pipe that will move up or down the pipe depending on reservoir elevation and flow.
- Air blow-back can occur depending on the pipe slope and discharge. This could result in violent surges and may require anchoring the pipe.
- The vertical well needs to resist the full momentum of the flow, which could be substantial for large discharges and higher heads.

### 5.2.2 Design guidance

The design of a stilling well requires knowledge of the conduit diameter, conduit slope, and design discharge. When determining the design discharge, caution is recommended to ensure the selected value fully encompasses the full range of expected operating conditions.

Using the approach conduit diameter ( $D_a$ ) and design discharge ( $Q$ ), the stilling well diameter may be determined as shown in figure 67. After the well diameter is selected and using the slope of the approach conduit (vertical drop/horizontal distance), the depth of the stilling well ( $T$ ) below the approach conduit invert may be determined as shown in figure 68.

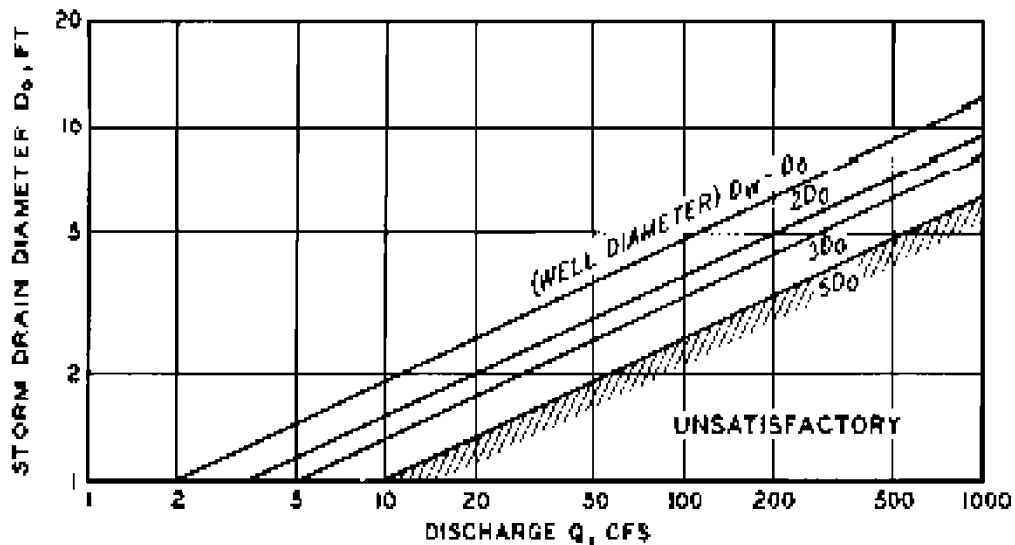

Figure 67.—Determination of storm drain conduit stilling well diameter (USACE, WES, HDC Sheet 722-1, 1973). See USACE (1973) for information related to the variables as denoted in this figure.

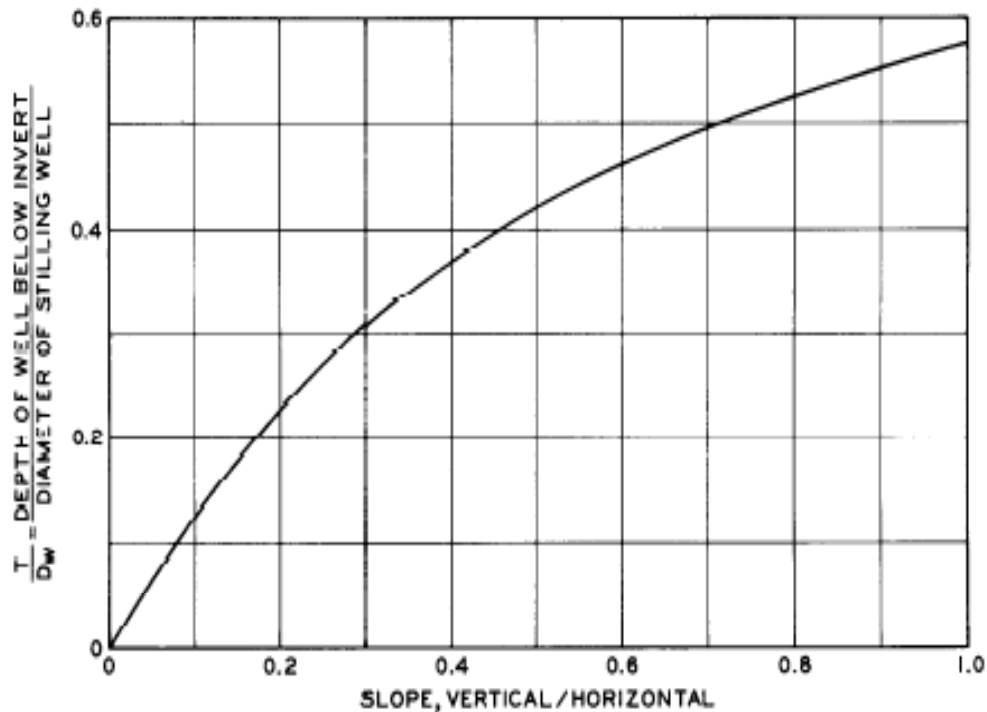

Figure 68.—Depth of USACE stilling well below conduit invert (USACE, WES, HDC Sheet 722-1, 1973). See USACE (1973) for information related to the variables as denoted in this figure.

The stilling well diameter may be used to derive the minimum height of the stilling well top above the approach conduit invert. This height is often selected as  $2D_w$ . However, this height may be greater to fit site geometry or increased to provide additional energy dissipation to fit site constraints.

After selecting the stilling well top elevation, the total height of the well may be determined by adding the stilling well height and the stilling well depth. A final practical adjustment is often included to enlarge the well diameter to match standard available precast size and site conditions. If other adjustments are needed to match site conditions, the preferred method of modification is to increase the stilling basin height. Refer to available guidance from the USACE (WES, HDC 722-1, 1973) for additional design details, design guidance, and a complete discussion of the physical model and test results. The physical model report presents test results for both full and partial pipe flow and a measurement of the amount of energy dissipation achieved within the stilling well (USACE, 1963).

### 5.2.3 Other considerations

Installation of rock riprap around the stilling well outlet and in the downstream exit channel should be included. Standard rock riprap design for turbulent conditions is generally adequate for rock sizing. The zone of protection should extend a minimum of three times the well diameter or two to four times the channel width downstream of the stilling well exit (FHWA, 1983, section 10-B).

More than one type of energy dissipator is often applicable. In such cases, local terrain, tailwater conditions, and comparative cost analyses will contribute to selection of the most practical energy dissipator for protecting the outlet. Three commonly used dissipators include the stilling well, the Reclamation impact type basin, and the hydraulic jump stilling basin. The range of applicability for the three basins varies with maximum discharge relative to the diameter of the conduit diameter (USACE, 1984, table 20-1, p. 20-10). Based on values of the relative maximum discharge capacity for comparable relative widths of the three energy dissipators, the stilling well is particularly suited to the lower range of discharges, the Reclamation impact type basin to the intermediate range of discharges, and the hydraulic jump stilling basin to the higher range of discharges.

## Chapter 6

# Conduit Outlet Expansions (Flow Transitions)

The conduit outlet expansion structure reduces eddies and turbulence that are typically associated with a sudden expansion and provides protection for the toe of the dam and the channel side-slopes in this transition zone. The expansion may either be designed so that the hydraulic jump is contained within the structure, or it may be utilized to provide a uniform flow profile prior to entry into a different type of stilling basin. The energy dissipation provided by this type of structure is often incomplete, and the downstream channel is frequently armored with riprap or grouted riprap in the turbulent zone downstream from the expansion structure.

### 6.1 Expansion to a Channel

The simplest form of conduit outlet expansion discharges directly into either a stream channel or a canal. This form of expansion provides minimal energy dissipation—its primary function is to smoothly transition the flows from the confines of the conduit to the channel section with a minimum amount of turbulence. This transition structure is relatively small and can be extremely cost effective but must be used in conjunction with downstream armoring or a plunge pool. The expansion has the advantage that it is self-cleaning and does not tend to accumulate debris. Although it is typically used on low head structures, the conduit outlet expansion has been utilized successfully on dams with operating heads of up to 90 feet and with conduits up to 8 feet in diameter. [Figure 69](#) shows an example of a conduit outlet expansion.

### 6.2 Expansion with a Hydraulic Jump

The conduit outlet expansion may be designed to fully contain the hydraulic jump by depressing the floor and adding an end sill. The floor is typically depressed approximately  $0.5D$  (where  $D$  is the conduit diameter), and the top of the end sill is commonly set to the same elevation as the invert of the outlet conduit ([figures 70](#) and [71](#)). This type of structure depends on the formation of a hydraulic jump for energy dissipation, consequently tailwater must be considered in the design process. The downstream channel should be designed to ensure that the flow is subcritical,



(a) The discharge is  $270 \text{ ft}^3/\text{s}$  with an approximate Froude number equal to 1.6.



(b) The discharge is  $400 \text{ ft}^3/\text{s}$  with an approximate Froude number equal to 2.0.



(c) Minor scour exists downstream from the structure after sustained discharge of  $270 \text{ ft}^3/\text{s}$ .

**Figure 69.**—This outlet works conduit is a 54-inch diameter horseshoe shape, with a normal operating head of 66 feet. Note that the hydraulic jump occurs downstream from the transition structure.



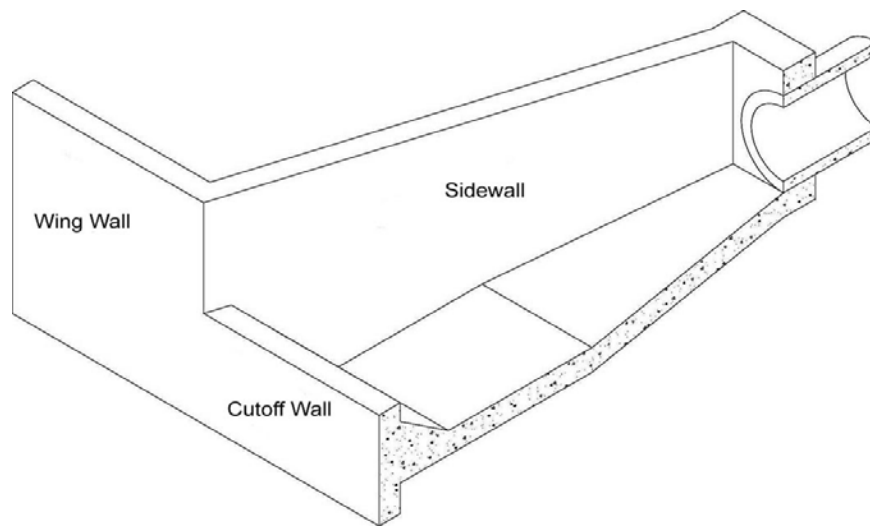

Figure 70.—Half isometric drawing of one half of a USDA-NRCS type PWD basin.



Figure 71.—7.5-foot horseshoe conduit discharging into an outlet expansion with a depressed floor. Downstream channel armoring has also been provided.



and the flow depth is above the critical depth at the end sill. This dissipator design may be utilized for Froude numbers up to 2.0. The NRCS provides design guidance for this basin configuration for hydraulic heads of up to 20 feet and conduit diameters of up to 72 inches. The basin is referred to as a public works department (PWD) basin in [NRCS's \*Gated Outlet Appurtenances\* \(1969, p. F-21\)](#).

The [Nilan North Dam case history](#) in the appendix discusses the replacement of an outlet transition structure.

### 6.3 Expansion to a Stilling Basin

The conduit outlet expansion may be necessary to provide a smooth transition from the conduit portal to a larger stilling basin such as a plunge basin or hydraulic jump type basin. The expansion provides a uniform flow profile and reduced unit discharge at the stilling basin entrance. A sloping, or parabolic drop to the floor of the stilling basin is commonly incorporated into the configuration to provide the required tailwater depth. Flow depth decreases, and velocity increases in the downstream direction as the flow leaves the confines of the conduit, and the Froude number increases correspondingly. As such, the stilling basin design should be based upon the depth and velocity of the flow at the exit of the transition section, instead of at the outlet portal. This configuration may be utilized for a very wide range of Froude numbers and stilling basin configurations.

### 6.4 Design Guidance

[FHWA's HEC-14 \(2006\)](#) provides both conceptual hydraulic design development and specific design guidance for conduit outlet expansions. The design guidelines are based upon the Froude number (or equivalent Froude number) at the conduit outlet. Although the design guidelines are directed toward highway culverts, much of the conceptual development applies to outlet works energy dissipators.

The conduit outlet expansion discussion in [USACE's EM-1110-2-1602 \(1980\)](#) provides detailed design guidance for a wide variety of outlet works stilling basin configurations including flared outlet transitions ([figure 72](#)). The flared outlet transition discussion is primarily based upon model studies conducted by [Fletcher and Grace \(1972\)](#). Fletcher and Grace relate the recommended length and tailwater of the transition to the parameter  $Q/D^{2.5}$ . With low tailwater, this flared outlet transition structure may be used with  $Q/D^{2.5}$  values less than 2.0. With high downstream tailwater, the values of  $Q/D^{2.5}$  can be as high as 6.0.



Figure 72.—A flared outlet transition.

This parameter is equivalent to a Froude number by the following expression:

$$\frac{Q}{D^{2.5}} = \frac{\pi\sqrt{g}}{4} F_1 \quad \text{eq. 12}$$

where,

$Q$  = discharge from conduit (ft<sup>3</sup>/s)

$D$  = conduit diameter (ft)

$g$  = acceleration due to gravity (32.2 ft/s<sup>2</sup>)

$F_1$  = Froude number

NRCS's TR-46 (1969) presents detailed design guidelines for a flared outlet transition with a depressed floor and end sill that contains the hydraulic jump (Type PWD). Several standard sizes have been developed for a variety of conduit diameters and operating heads. The conduit discharge and equivalent Froude number are not explicit design parameters, but are indirectly incorporated in terms of the operating head and conduit diameter. The recommended upper boundary for this basin configuration corresponds roughly to a Froude number of 2.0. The standardized design in TR-46 is conceptually very similar to the recommendation in USACE's EM-1110-2-1602 (1980) that the flared outlet transition may be made much more efficient by depressing the floor  $0.5D$  and adding an end sill.

### 6.5 Design Considerations

The primary design considerations for the conduit outlet expansion include:

- *Entrance velocity and Froude number.*—The Froude number ( $F_1 = v_1 / (gd_1)^{1/2}$ ), is typically utilized to configure the basin. For circular conduits flowing full, an equivalent depth of  $d_1 = (A/2)^{1/2}$  (where  $A$  is the cross-sectional flow area) may be utilized to estimate “ $d_1$ ”, so that an approximation of  $F_1$  may be obtained. The Froude number should not generally exceed the values given in table 4.

Table 4.—Conduit outlet expansions

Maximum Froude number	Transition from	Tailwater considerations	Design guidelines
0.6	Expansion to a channel	Low tailwater	EM-1110-2-1602, HEC-14, and Fletcher and Grace
1.5		High tailwater	
2.0	Expansion with a hydraulic jump	Maintain tailwater above critical depth at end sill	EM-1110-2-1602, TR-46, and HEC-14
Depends upon basin type	Expansion to a stilling basin	Depends upon basin type	EM-1110-2-1602 and HEC-14

- *Flare angle.*—The flare angle should not expand more rapidly than the entering jet is capable of expanding, nor so gradually that the basin is excessively long. For Froude numbers below 3, the flare angle may be relatively abrupt, but should not exceed  $1:3F_1$ , as indicated in HEC-14, where 1 is the dimension normal to flow, and  $3F_1$  is the dimension aligned with the flow. For higher Froude numbers, EM-1110-2-1602 indicates that the flare angle should not exceed  $1:2F_1$  or 1:6 (whichever is more gradual). Excessively large flare angle result in a nonuniform flow profile and undesirable flow characteristics.
- *Length.*—The length necessary to prevent excessive scour without a downstream stilling basin is a function of the Froude number, tailwater depth, and conduit diameter. In highly erodible materials, this length tends to be prohibitively long with Froude numbers above 0.6. Typically, the flare angle and the dimensions of the downstream channel constrain the length. Either channel armoring or a downstream stilling basin are also typically necessary because there will be minimal energy dissipation in the transition structure.

The length of the basin may be reduced by depressing the floor and designing the basin to contain the hydraulic jump following guidance in either [NRCS \(1969\)](#) type PWD or [USACE \(1980\)](#).

- *Tailwater depth.*—The effectiveness of the conduit outlet expansion can be greatly increased by ensuring adequate tailwater. The tailwater may be maintained with either a downstream weir or an appropriately configured downstream channel. Tailwater considerations include:
  1. *Low tailwater.*—In cases where a low tailwater is desired, particular care must be taken to ensure that there is not excessive scour downstream from the expansion structure—particularly since it is typical that the hydraulic jump and energy dissipation will occur downstream from the structure. The exit velocities and downstream bed materials must be considered carefully in conjunction with protective measures such as downstream channel protection (see [chapter 9](#)), the cutoff wall depth, and wing walls.
  2. *High tailwater.*—A higher tailwater may be utilized to reduce exit velocities and subsequent scour depths. If this design forces the hydraulic jump to occur within the conduit outlet, particular care must be taken to ensure that the conduit is large enough and that adequate venting is provided upstream from the hydraulic jump. If the conduit is too small or inadequately vented, the flow may become unstable and alternate between full conduit flow and partial conduit flow. The resulting pulses have the potential to damage gates and may create large splashes at the conduit portal. Additional consideration must be given to the sidewall height, to ensure that the tailwater does not submerge the basin.
- *Downstream channel protection.*—Typically, it is necessary to provide some form of channel protection downstream from the conduit outlet expansion. The guidelines presented in [chapter 9](#) should be utilized.

Secondary design considerations include:

- *Cutoff wall depth.*—The depth of the cutoff wall should be extended enough to prevent undermining of the basin due to either local scour or channel degradation.
- *Wing wall width.*—The wing walls should be extended such that they are fully embedded in the channel sides. An additional allowance should be made for the eventuality of downstream scour.
- *Basin wall height.*—The basin walls or wing walls should be higher than the anticipated downstream tailwater elevation.
- *Structure backfill.*—The backfill material behind the walls should allow for free drainage, and any accumulations of water should be discharged through a

collection pipe. The free draining material reduces the loads acting on the walls and helps to reduce damage from backfill frost heave in cold climates. On an embankment dam, this is often an important seepage monitoring point, and as such, the discharge pipe should be elevated sufficiently or be located to minimize the potential for tailwater submergence. The collection pipe should be sized to allow for inspection by CCTV equipment (see the guidance provided in [section 2.6.6](#)).

## Chapter 7

# Valve and Gate Selection and Energy Dissipation Requirements

This chapter discusses valves and gates commonly used to control outlet works discharge and the energy dissipation methods that can be considered for each. The valve or gate is an integral component of the outlet works. The location, flow characteristics, and losses through the valve or gate must be considered when designing an energy dissipator. Some valves and gates (e.g., jet-flow gates and bonneted slide gates) provide relatively little energy dissipation, whereas others (e.g., fixed-cone, ported sleeve, and Monovar valves) can serve the dual function of control and energy dissipation. The location of the valve or gate in relation to the other outlet works features and the downstream channel significantly influences the effectiveness and efficiency of the valve or gate as an energy dissipator.

Valves and gates are mechanical devices that control the flow in a conduit, pipe, or tunnel. A valve differs from a gate in that a portion of the waterway is permanently obstructed by the valve itself, whereas a gate, when in its fully open position, does not obstruct any portion of the waterway. Different names are often used for the same device in different countries and in different organizations within a country. The more generic nomenclature has been used in this chapter.

### 7.1 Fixed-Cone Valves

The fixed-cone valve ([figure 73](#)) is the most commonly used valve for regulating discharge at medium and high head dams. The fixed-cone valve (also known as a Howell-Bunger valve) has a cylindrical body with an upstream connecting flange and a cone at the downstream end to disperse the flow of water into the atmosphere. The body has internal radial vanes that extend beyond the downstream end of the body and connects to an upstream-facing conical section. A moveable cylindrical sleeve fits over the body and moves axially to seat against the cone, shutting off the flow. The maximum opening of the valve is usually such that the open area of the valve is slightly less than the area of the upstream conduit. This prevents control shifting from the valve to the upstream pipe. The minimum opening is generally set at about 5 percent of the sleeve travel to prevent cavitation damage of the cylinder and seal ring. The sleeve may be operated



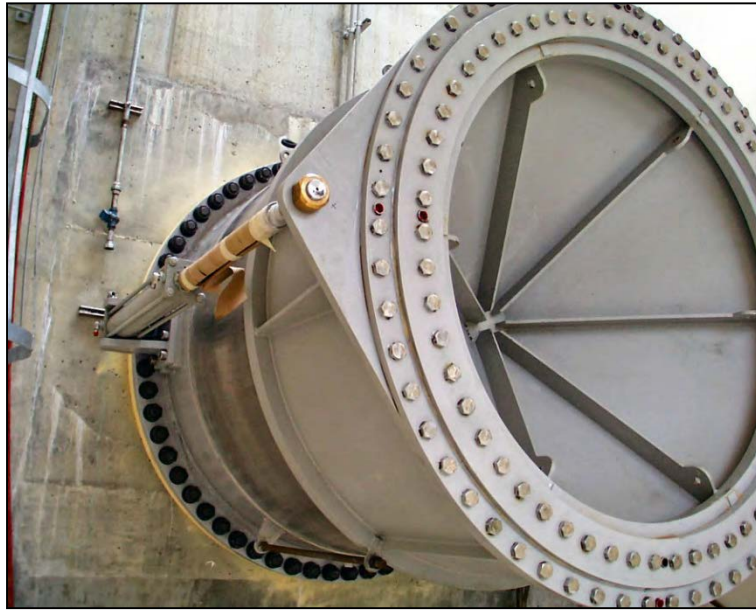

Figure 73.—Fixed-cone valve.

by a power screw type device (see [figure 80](#)) or by dual hydraulic cylinders. Sizes of the valves range from 6 to 132 inches in diameter with heads up to 570 feet.

### 7.1.1 Performance

The fixed-cone valve is a very good regulating valve with good energy dissipation due to its highly dispersed discharge jet. Water discharging from the valve has an expanding, cone-shaped discharge pattern that results in great quantities of spray; refer to [figure 74](#). The valve is often equipped with a discharge hood to confine the discharge, or it is installed inside of a discharge vault. The circular orifice enables the valve to be installed without transitions and provides linear discharge capabilities.

Discharge from fixed-cone valves naturally disperses into the air in the shape of a hollow, expanding cone. Expansion and dispersion of the discharge jet reduce the pressure of the jet at impact and reduce potential stream bed erosion. Energy dissipation structures are often not required when the jet from the fixed-cone valve is allowed to expand into the air before returning to the stream channel. A fixed-cone valve discharging in free air at a small opening is shown on [figure 74](#), and a fixed-cone valve discharging at a large opening is shown on [figure 75](#). The valves may be supplied with a hood to reduce spray and jet expansion. They may also discharge into a variety of energy dissipation structures, as discussed in the following sections. The fixed-cone valve has been used in the horizontal position for outlet works and in the vertical position with vertical stilling wells ([chapter 5](#)).





Figure 74.—Fixed-cone valve discharging at a small opening.



Figure 75.—Fixed-cone valve discharging at a large opening.

### 7.1.2 History

Reclamation engineers C.H. Howell and Howard Bunger developed the fixed-cone valve. The valve is now commercially available and is widely used throughout the world to regulate flow from medium and high head dams. Fixed-cone valves are also known as fixed-cone dispersion valves or hollow cone valves (in Canada). The first fixed-cone valve was designed for El Vado Dam in New Mexico by dam designers Messrs. Howell and Bunger. Following that installation, the vanes of several valves failed (Parmakian, 1968). This led to a study by Mercer (1970) who determined the failure modes and a criterion to prevent failure. Reclamation's largest valves are the 138-inch diameter valves at New Waddell Dam. The highest head (570 feet) fixed-cone valves in the United States are the 78-inch diameter valves at New Melones Dam. The fixed-cone valve has replaced the hollow-jet valve, which is no longer used.

The use of fixed-cone valves has several advantages and disadvantages with respect to energy dissipation. Advantages include:

- Dissipation of energy by dispersing the jet into the air can eliminate the need for energy dissipation structures.
- Commonly used for controlling free discharge release from and medium and high head dams.
- Durable design with few moving parts and easy to inspect.
- Historically low maintenance requirements.
- Simple low torque actuation with electric, hydraulic, or manual operation.
- Nearly linear valve-opening-versus-discharge characteristics.
- Round flanged design connects directly to pipe without need of a transition section.
- High coefficient of discharge,  $C_d = 0.82$  to  $0.85$ .

Disadvantages include:

- Ice formed by spray in cold climates may create maintenance and worker safety issues. An example of ice formation due to winter discharge from fixed-cone valves at Strontia Springs Dam is shown on [figure 76](#).
- Spray can cause problems for nearby electrical equipment.



Figure 76.—Ice build-up under 48-inch diameter hooded fixed-cone valves. Ice has built to the elevation of the bottom of the valve operating deck, approximately 60 feet above streambed. Photo courtesy of Denver Water.

- Widely dispersing spray can be objectionable to workers or local residents in affected areas.
- Debris trapped in the valve can cause maintenance and performance problems.
- Operation at small openings (less than 5 percent) is not recommended by valve suppliers because of concerns associated with valve vibration and damage from cavitation.
- Generally not suitable for operation under partial submergence, although with proper aeration, some have been designed to operate submerged. Vibration of the cone becomes a significant problem when operating submerged. When designing fixed-cone valve installations, designers need to verify that tailwater will not submerge the valve during operation.

Energy dissipation methods to consider for unhooded fixed-cone valves include:

- Discharge directly to a stream channel or to an excavated plunge pool.
- Discharge into energy dissipation chambers.

### 7.1.3 Fixed-cone valve discharging into horizontal energy dissipation chambers

Reclamation, the USACE, and others developed this modern energy dissipation structure. This design consists of a rectangular box dissipation structure containing a deflector ring (baffle). Flow from the fixed-cone valve discharges into a concrete box structure where the spreading jet from the valve impacts and deflects against a deflector ring located on the chamber walls, floor, and roof. The concentric baffle ring causes the annular jet to deflect. The energy loss is due to jet impact on the walls and impingement of the jet downstream of the deflector ring. Valve manufacturers use different fixed-cone angles that need to be considered when locating the deflector ring. This consideration is especially important when replacing a fixed-cone valve.

The design has been standardized as a result of extensive model studies and prototype performance history. This type of energy dissipator can be designed using single or tandem dissipation chambers. The tandem chamber design is used where additional energy dissipation is required before the flow can be released to the downstream channel. [Figure 77](#) shows the design drawing of a 46.5-foot long by 23-foot wide chamber used to dissipate energy from a 54-inch diameter valve. An example of an operating tandem chamber is shown in [figure 78](#).

The use of fixed-cone valves discharging into horizontal energy dissipation chambers has several advantages and disadvantages with respect to energy dissipation. One advantage is that the horizontal energy dissipation chamber design is a relatively standard, with a documented history of successful performance. One disadvantage is that the size of the chamber depends on the valve diameter; therefore, large, reinforced concrete structures are required for large valves.

Historical problems of fixed-cone valves discharging into horizontal energy dissipation chambers have included:

- Steel plate linings have often been placed on the deflectors in the dissipators. The failure of these steel linings at Abiquiu Dam in New Mexico and Oroville Dam in California has shown that steel plates were unnecessary and were removed.
- If insufficient air is provided at the valve, surging in the dissipation chamber will be generated. This problem was corrected at Cheesman Dam and at Round Butte Dam. Denver Water solved the problem at Cheesman Dam by increasing the size of the air vents above the valve to stop the surging.



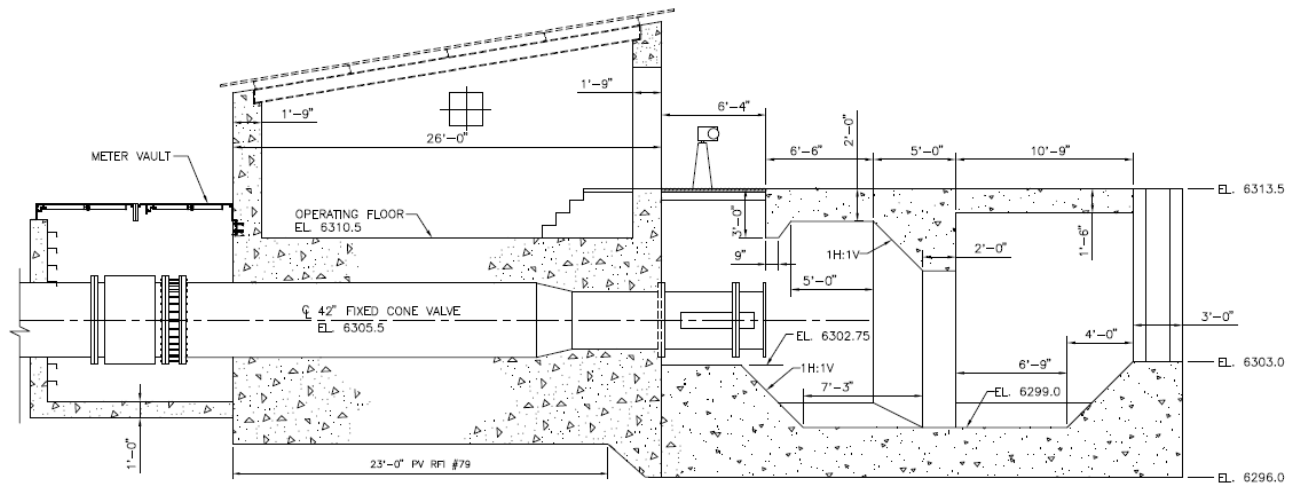

Figure 77.—Typical section through fixed-cone valve horizontal energy dissipator. Figure courtesy of URS Corporation.



Figure 78.—Discharge from a 96-inch diameter hollow-jet valve on the left (looking upstream) and a 108-inch diameter fixed-cone valve on the right. The discharge from the fixed-cone valve is very calm after passing through the two stage chamber, the spray seen is inside the 2nd stage of the chamber. However, a wave suppressor is required as seen at the bottom left of the figure.

### 7.1.4 Hooded fixed-cone valve

A hooded fixed-cone valve has a large cylindrical body (hood) attached to the moveable sleeve of the fixed-cone valve. The hood contains and redirects the flow downstream, instead of allowing a wide spray into the atmosphere. Older hood designs have used a short section of pipe encased in concrete downstream of the valve to contain the jet.

Modern designs use hoods (supplied by the valve manufacturer) attached to the moveable sleeve. For example, the Rodney Hunt Company supplies a fixed-cone valve with a hood under the trade name of Ring Jet Valve; refer to [figure 79](#) for their standard dimensions for fixed-cone valves and hoods. The distance between the end of the fixed-cone valve and the hood is critical. Severe blowback has been experienced in prototype installations where this distance was off by only an inch or two. A hooded fixed-cone valve is shown on [figures 80](#) and [81](#).

Hooded fixed-cone valves can cause greater downstream erosion than those with no hoods because of the jet concentration caused by the hood. For example, the newly installed fixed-cone valves at Eleven Mile Canyon Dam required downstream channel improvements and slope protection when bank erosion occurred upon initial valve testing ([figures 82](#) through [84](#)).

The advantages of fixed-cone valves with hoods include:

- Contain spray (useful where space is limited).
- Standardized design.

Disadvantages include:

- Substantial distance downstream from the valve required to contain the jet.
- Increased downstream erosion potential.
- Hoods can alter operating load on the valve actuator.
- Valve manufacturers impose greater head limitations for fixed-cone valves supplied with hoods than for fixed-cone valves supplied without hoods.
- Lower discharge coefficient than for an unhooded fixed-cone valve.
- Additional cost of hood.

* C207 CLASS D (175 PSI.)								RING JET VALVE	
A	B	*C	*D	*G	*H	*J	K	N	P
6	28	11.00	9.00	8	0.87	0.69	8	11	6
8	30	13.50	11.75	8	0.87	0.69	8	14	8
10	32	16.00	14.25	12	1.00	0.69	8	18	10
12	38	19.00	17.00	12	1.00	0.82	10	21	12
14	40	21.00	18.75	12	1.12	0.93	10	25	14
16	42	23.50	21.25	16	1.12	1.00	10	29	16
18	48	25.00	22.75	16	1.25	1.06	12	32	18
20	50	27.50	25.00	20	1.25	1.12	12	35	20
24	54	32.00	29.50	20	1.37	1.25	12	42	24
30	64	38.75	36.00	28	1.37	1.50	14	52	30
36	70	46.00	42.75	32	1.62	1.62	14	62	36
42	76	53.00	49.50	36	1.62	1.75	14	72	42
48	86	59.50	56.00	44	1.62	1.75	16	82	48
54	92	66.25	62.75	44	1.87	2.12	16	92	54
60	102	73.00	69.25	52	1.87	2.25	18	102	60
66	108	80.00	76.00	52	1.87	2.50	18	112	66
72	118	86.50	82.00	60	1.87	2.62	20	122	72
78	124	93.00	89.00	64	2.12	2.75	22	USE SEPARATE HOOD	
84	134	99.75	95.00	64	2.12	2.75	22		
90	140	106.50	102.00	68	2.37	3.00	22		
96	150	113.25	108.50	68	2.37	3.00	24		
102	156	120.00	114.50	72	2.62	3.25	24		
108	162	126.75	120.75	72	2.62	3.25	24		

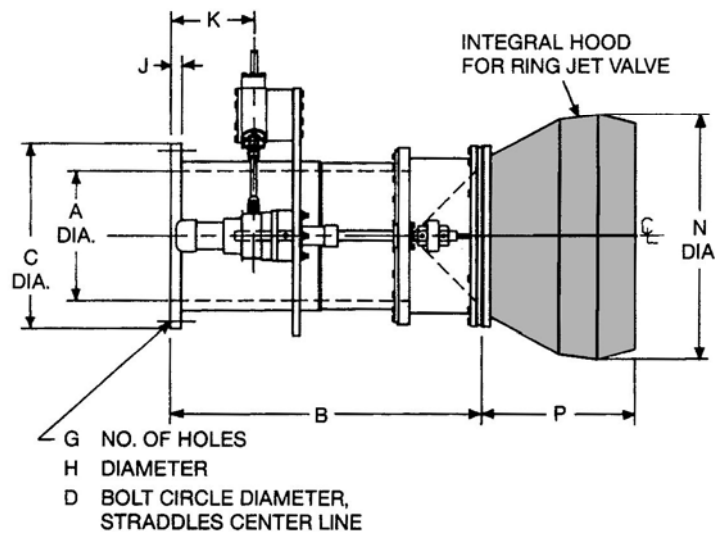

Figure 79.—Manufacturer’s standard valve and hood dimensions for fixed-cone valves. Figure courtesy of Rodney Hunt Corporation.





Figure 80.—Hooded fixed-cone valve. Photo courtesy of URS Corporation and Denver Water Board.



Figure 81.—48-inch diameter hooded fixed-cone valve discharge. Photo courtesy of URS Corporation and Denver Water Board.



**Figure 82.**—48-inch diameter hooded fixed-cone valve discharge. Photo courtesy of URS Corporation and Denver Water.



**Figure 83.**—A 48-inch diameter hooded fixed-cone valve. Note erosion of riprap in downstream channel. Photo courtesy of URS Corporation and Denver Water Board.



**Figure 84.**—Erosion of riprap downstream from a 48-inch diameter hooded fixed-cone valve. Photo courtesy of URS Corporation and Denver Water Board.

Energy dissipators that can be considered for hooded fixed-cone valves include:

- Direct discharge to plunge pool or stream channel.
- *Experimental energy dissipating hood.*—[Johnson and Dham \(2006\)](#) conducted experiments to investigate appurtenances in the hood that would reduce the energy of the flow discharging from the valve. These appurtenances included deflector rings within the hood, different orifice diameters at the end of the hood, and baffles. They found that baffles in the hood were the most effective device to dissipate the energy of the flow. However, tests were not performed that would indicate the increased loading on the operating mechanism due to the appurtenances. This concept has not been implemented in field applications.

### 7.2 Sleeve Valves

There are two basic sleeve valve designs: the bottom discharge sleeve valve and the multi-ported sleeve valve. The bottom discharge sleeve valve has a cone at the bottom of the pipe that directs the discharge to the floor of the submerged stilling well ([figure 85](#)). The more common multi-port sleeve valve has multiple ports through the wall of the lower section of the pipe, which directs the discharge to the sides of the submerged stilling well. The water in the stilling well rises and passes through an overflow section. Another variation of the valve has a horizontal multi-



Figure 85.—A bottom discharge sleeve valve being fabricated.

port pipe with external sleeve, which discharges into a larger integral horizontal chamber.

The sleeve valve openings can be orifices, slots, or V-notches. Sleeve valves are often used to control flow and dissipate energy at medium and high head installations. Because of their design, sleeve valves are usually used at installations that require the dissipation of high heads with a wide range of discharge.

The beginning of this section discusses the multi-ported sleeve valves installed in horizontal stilling wells, vertical stilling wells, and pipelines. Bottom discharge sleeve valves are discussed at the end of this section. Design of vertical stilling well energy dissipators (for bottom discharge sleeve valves) is also discussed in [chapter 5](#).

### 7.2.1 Performance

The valves provide very good energy dissipation under a wide range of head and discharge. Older designs are noisy and vibrate considerably. Performance of sleeve valves is described in more detail in the following paragraphs of this section.

### 7.2.2 History

Reclamation's first bottom sleeve valve was installed at Wanship Dam in 1955. The largest of Reclamation's bottom discharge sleeve valves are the 54-inch diameter valves installed at Mt. Elbert Forebay Dam and Upper Stillwater Dam.

### 7.2.3 Multi-ported sleeve valves

A multi-ported sleeve valve consists of a cylindrical body with a moveable sleeve inside or outside of the body. The body is fabricated with numerous small, tapered ports, which break the flow into many small jets. The energy dissipation from the multi-ported sleeve valve is primarily from the sudden expansion of the small jets into a large space. A moveable sleeve controls the number of ports exposed and the resultant discharge area.

The requirements for energy dissipation structures at high head facilities can be greatly reduced or eliminated when using multi-ported sleeve valves. These reduced structural requirements are one of the primary benefits of using the multi-ported sleeve valve. Three common installation alternatives for sleeve valves are applications in vertical stilling wells, horizontal energy dissipators, and inline pipelines. Multi-ported sleeve valves have several advantages with respect to energy dissipation, especially at high head facilities.

The advantages of multi-ported sleeve valves include:

- Multi-ported sleeve valves can dissipate flow from very high heads (in excess of 1,000 feet), often without the need for a separate energy dissipator.
- Multi-ported sleeve valves can be designed for a wide range of precise discharge control.
- Well designed facilities can almost eliminate the potential for damage from cavitation, both at the valve and at the dissipation structure.
- The multi-ported sleeve valve has a long history of successful use but is more commonly used as an inline pressure-reducing valve and is less commonly installed for regulating free discharge at dams.
- The small forces required to actuate the sleeve means it can be easily actuated manually through a gearbox.
- The multi-ported sleeve valves have a long and successful performance history of high head energy dissipation and flow regulation.



- The multi-ported sleeve valve is commercially available with supply and servicing from at least two major U.S. valve manufacturers.

Disadvantages include:

- Costly to manufacture because of the numerous small ports built into the valve body.
- Requires relatively debris-free water or a screening system. Strainers are often required when the valve is installed at raw water installations. Figure 86 shows an example of the strainer required for an inline multi-ported sleeve valve.
- The multi-ported sleeve valve has much smaller ports than the V-ported sleeve valve and is more susceptible to plugging with debris.

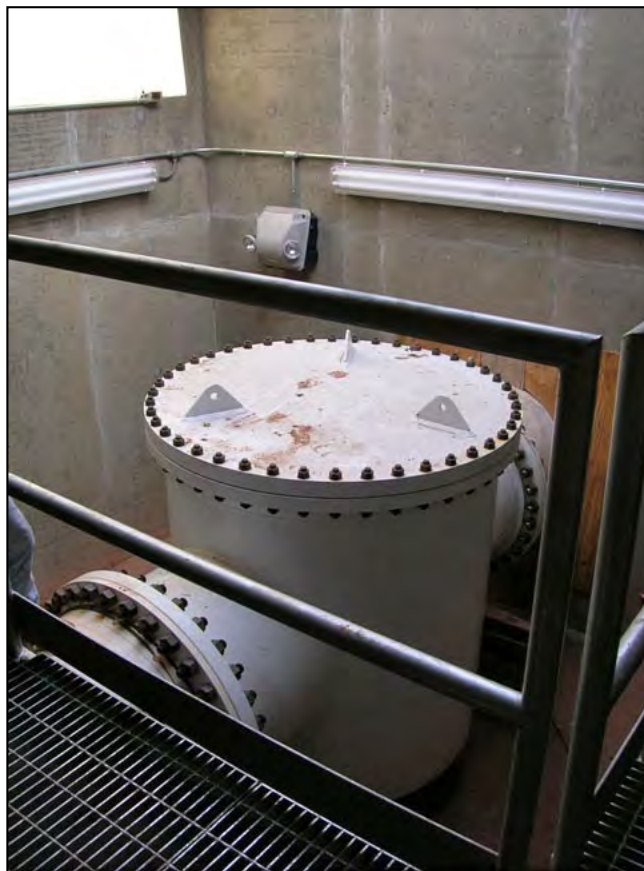

Figure 86.—Basket strainer for a multi-ported sleeve valves. Photo courtesy URS Corporation.



### 7.2.3.1 Horizontal energy dissipators for multi-ported sleeve valves

When compared to the vertical stilling well, the horizontal stilling well can improve access, reduce unwatering requirements, and reduce the depth of excavation. A manufacturer's schematic drawing for a horizontal sleeve valve is shown in [figure 87](#), and an example of a horizontal sleeve valve discharging to a stilling well is shown in [figure 88](#).

Multi-ported sleeve valves have several advantages with respect to energy dissipation, especially at high head facilities. Some of the advantages include:

- Reduced excavation and unwatering requirements.
- Improved access to the valve for operation and maintenance.
- Eliminated or improved confined space issues.

Disadvantages include:

- May require a slightly larger valve diameter because of reduced valve submergence.
- Potential for causing more noise (when compared to buried vertical stilling wells with submerged valves).

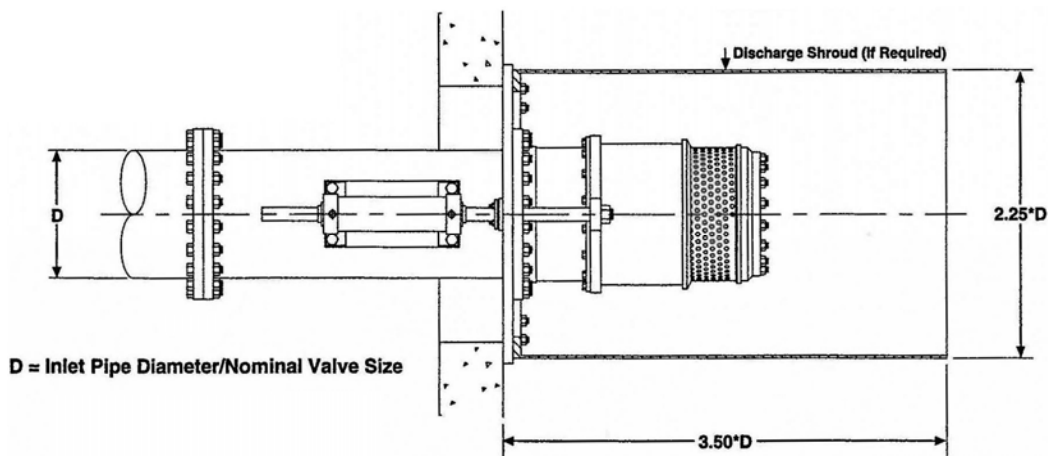

Figure 87.—Model 814 Polyjet Sleeve Valve. Manufacturer's standard dimensions for a horizontal sleeve valve discharging to free air. Drawing courtesy of Bailey Valve, Inc.



**Figure 88.**—The 48-inch diameter sleeve valve is located within a valve house and discharges directly into a horizontal stilling well. Photo courtesy of URS Corporation.

- Greater potential to be adversely affected by large variations in tailwater when compared to submerged valves in vertical stilling wells.

### **7.2.3.2 Vertical stilling well energy dissipators for multi-ported sleeve valves**

The following is a list of advantages of vertical stilling wells for multi-ported sleeve valves (in addition to those listed in [section 7.2.3](#)):

- The design is ideally suited for environmentally sensitive areas where noise, spray, or turbulent flow must be minimized. If the well is below ground level, these valves are extremely quiet.
- If the valve is submerged in a well for normal conditions, it will not be adversely affected by large variations in tailwater.
- The submerged well can be designed to provide tranquil discharge that does not interfere with slowly swimming fish.
- The submerged well can be designed with an overflow weir to provide an approximate method for determining discharge flow.

## Outlet Works Energy Dissipators

- The vertical sleeve valve design will have more backpressure on the valve than the horizontal well design. The greater backpressure can reduce the potential for cavitation and result in a slightly smaller valve diameter when compared to a horizontal stilling well design.
- The multi-ported sleeve valve has a standard pit design provided by the valve supplier. The valve manufacturer (figure 89) can provide standard dimensions of vertical stilling wells for multi-ported sleeve valves.

Disadvantages of multi-ported sleeve valves in vertical stilling well include:

- Stilling wells may be very deep for large diameter valves, which makes valve access, unwatering, and maintenance difficult (common for both multi-ported and bottom discharge designs).
- Need to be drained or pumped out for inspection and maintenance.

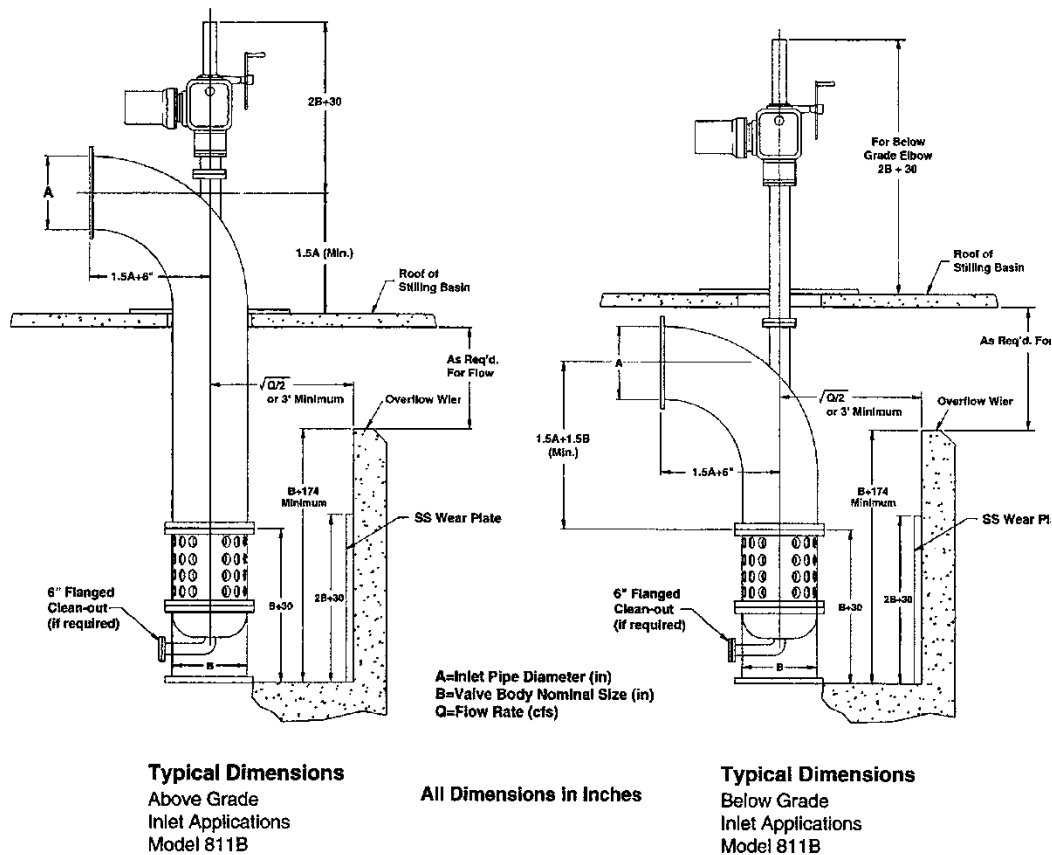

Figure 89.—Model 811 Polyjet Sleeve Valve. Typical vertical stilling well layout dimensions for vertical stilling well. Drawing courtesy of Bailey Valve, Inc.

- Often considered a confined space.
- Permanent ladders should be avoided because the high turbulence has been known to dislodge such structures in the well (common for both multi-ported and bottom discharge valve designs).

### 7.2.3.3 Vertical stilling well energy dissipator for bottom discharge sleeve valves

Historically, the bottom discharge sleeve valve was a common Reclamation design, but Reclamation and others in the United States rarely use it now. However, bottom discharge sleeve valves are used in Australia and in a number of Asian countries. A modern bottom discharge sleeve valve design (as supplied by Glenfield Valve in Scotland) uses large V-shaped bottom ports. For designs with a bottom discharge sleeve valve, the valve and the stilling well must be treated as a complete system to ensure optimum performance. Therefore, the dimensions of the stilling well should be determined in consultation with the valve supplier. Raising and lowering the movable sleeve located inside the V-ports at the bottom of the valve regulates discharge from the valve. Figure 90 shows an example of a stilling well during operation, and [figure 91](#) shows a photo of V-port openings. The large size of the V-port openings makes the valve less prone to clogging from debris when compared to the multi-ported sleeve valve design.



Figure 90.—Submerged discharge valve well for a manually activated 44-inch diameter valve.



**Figure 91.**—Bottom discharge of a submerged discharge valve. Note the V port openings.

Bottom discharge, V-ported sleeve valves have an advantage and certain disadvantages (when compared to multi-ported sleeve valves). The advantage is that these valves are less prone to clogging from debris than multi-ported sleeve valves because of the larger port size.

Disadvantages include:

- Limited performance history in the United States when compared to multi-ported sleeve valves. Research is needed to investigate performance history of the V-ported sleeve valves.
- The bottom discharge V-ported sleeves are uncommon in the United States and may not be commercially available for supply and servicing.

### 7.3 Multiple Orifice Valve

The body of a multiple orifice valve has a vertical, sliding, ported leaf, which slides against a ported plate with the same hole pattern as the leaf. Stroking the ported plate to open or close the ports regulates flow. Full opening or closing of the valve is achieved by stroking the ported plate (up or down) by only one port diameter. The valve is simple in concept and operation. Multiple orifice valves include the Monovar valve manufactured by Sapag and the MOV valve manufactured by Ross Valve. [Figure 92](#) shows a Monovar valve being fabricated. [Figure 93](#) shows a schematic drawing of a Monovar valve.



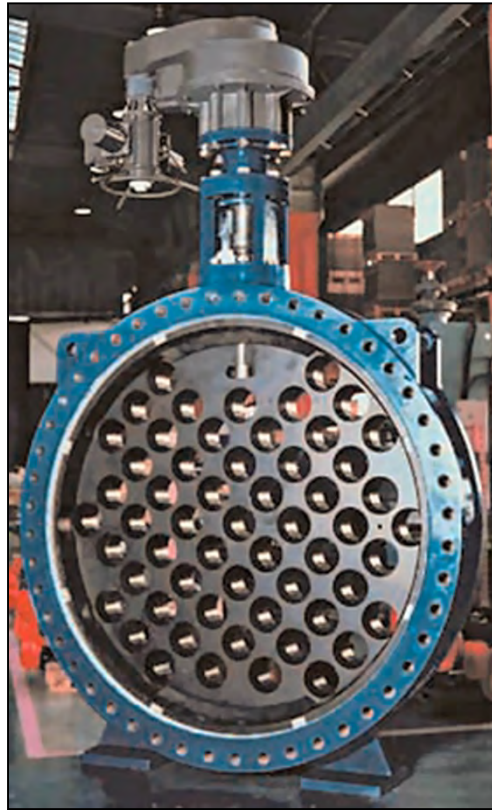

Figure 92.—Fabrication of a Monovar valve. Photo courtesy of Sapag.

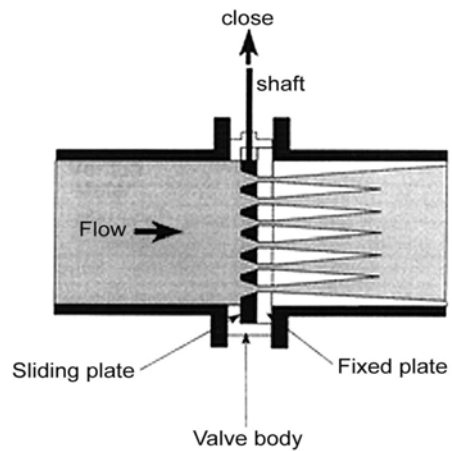

Figure 93.—Schematic diagram of a Monovar valve. Figure courtesy of Sapag.



### 7.3.1 Performance

Energy dissipation is accomplished by sudden expansion of the flow at the downstream side of the small port orifices. The hydraulics of the energy dissipation are similar to those of a multi-ported sleeve valve or a classic inline orifice plate. Multiple orifice valves have been used primarily for inline pressure reduction at high head water supply pipelines. The multiple orifice valve is not commonly used for outlet works control, but it has many unique advantages and can be considered for special design requirements such as projects where adequate space is not available for installation of more common valves and energy dissipators. [Figure 92](#) shows the short body length and operator height of the valve. In addition, the energy dissipation characteristics of the valve has the potential for eliminating the need for an energy dissipation structure. [Figure 94](#) shows a Monovar valve used for free flow regulation.

### 7.3.2 History

Multiple orifice valves have been used for turbine bypass applications in hydroelectric dams, flow or pressure control at water treatment plant inlets (or outlets), flow control in large pumping stations (when constant speed pumps are used), and fresh or seawater cooling systems. Also, a 40-inch diameter multi-orifice valve was used at Terminus Dam in California. In this case, the valve discharged freely into the downstream pool.

Multiple orifice valves have several advantages including:

- Compact design of valve bodies, both “flange to flange” and because of low headroom requirements.
- Extremely short valve stroke. The stroke length of the valve shaft is only one small port diameter.
- Simple mechanical design.
- Downstream seating arrangement results in relatively low leakage.
- May be used for high head energy dissipation.
- Relatively light valve body, which is relatively easy to install when compared with other outlet works control valves.
- Energy dissipation requirements may be reduced or eliminated because of energy dissipation characteristics of the valve.



Figure 94.—Monovar valve used as a free discharge valve. Photo courtesy of Sapag.

Disadvantages include:

- Expensive relative to many other outlet works control valves and gates.
- Commonly used as an inline pressure-reducing valve, but uncommon for use as an outlet works control valve.
- Requires relatively debris-free water or debris screening system.
- Requires larger valve diameter and upstream piping than other conventional valves because the leaf takes up more of the valve leaf area rather than the discharge ports.
- The short stroke can make precise flow control more difficult than with other control valves.
- Low coefficient of discharge ( $C_d$ ) because of the small ports, all acting like small orifices.

Energy dissipation structures that can be considered for multiple orifice valves are:

- Energy dissipation structures may not be required because of the energy dissipation characteristics of the valve.
- Plunge pools.

### 7.4 Butterfly Valve

Butterfly valves are not recommended for use in controlling free discharge from dams because of their poor ability to regulate discharge and potential to cavitate. They are mentioned in this section to alert the reader to their many disadvantages when used to regulate outlet works discharge.

A butterfly valve functions as a guard valve installed in outlet works or penstocks of dams or pumping plants and is used for emergency or maintenance shutoff of downstream regulating gates or valves, generating turbines, or pumps. In some instances, the valve has been used for limited regulating.

Butterfly valves are made with a hollow body and a round disk attached to a shaft, which passes through the middle of the disk. The disk is positioned perpendicular to the axis of the pipe to shut off flow. The disk is rotated 90 degrees to a parallel position for free flow. The rotating disk or leaf is supported by a cylindrical shaft or trunnion that passes through its centerline and through the valve body and is connected to the valve-operating mechanism. The shaft can be installed in a vertical or horizontal position with the horizontal position being the most common (figure 95).

#### 7.4.1 Performance

The butterfly valve is a very good guard valve, with most models having an adjustable seat to control leakage. The valve requires very little installation space and can be operated with a variety of operators including hydraulic, electric, or manual. The design velocity through the valve is restricted due to the obstruction of the leaf in the flow.

#### 7.4.2 History

The first butterfly valves installed by Reclamation were 9- by 12-foot butterfly gates installed at Boise Diversion Dam in 1912. The first actual butterfly valves were the 48-inch diameter valves installed at Minatare Dam in 1913. Sizes of the valve range from 4-inch diameter to the largest valves at Hoover Dam (168-inch diameter), which are also the highest head valves at 625 feet.

#### 7.4.3 Butterfly valves for regulating free discharge flow

Using a butterfly valve as an outlet works regulating valve has limited advantages, but many disadvantages. Among these limited advantages are:

- Requires a relatively low actuating force to operate due to balanced seating and unseating forces.

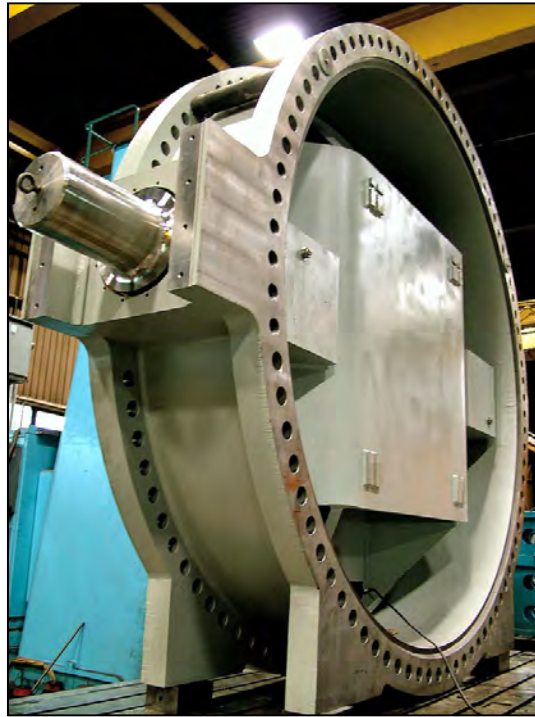

Figure 95.—Large diameter butterfly valve.  
Photo courtesy of Rodney Hunt Corporation.

- Relatively low cost when compared to other outlet works control valves.

Among the many disadvantages are:

- Shaft-actuated butterfly valves have severe operating restrictions because of maximum velocity limits (often under 20 ft/s for commercially available butterfly valves) due to torque limitation on the valve shaft and flow around the disk. However, special valve designs can be supplied with velocity limits above 60 ft/s.
- Damage to gate seats and disk, that can occur from high velocity flow.
- The valves are not typically designed for regulating free discharge.
- Cavitation potential at high velocity and/or partial openings.
- Flow control is difficult at certain openings (very nonlinear).
- Potential to damage or remove the seal on rubber-seated butterfly valves during emergency closure.

- Stem-actuated butterfly valves have a stem that projects through the flow path and is subject to damage from cavitation.

### 7.4.4 Butterfly valves for guard valve

Butterfly valves have been used as guard valves for emergency closure of an outlet works. Emergency closure conditions may occur during a burst pipe or penstock condition. During such emergency conditions, some damage to the seals is expected, and higher stresses are accepted. The aim is that the valve will close in such an emergency and stop the bulk of the flow. For flow velocities in excess of about 10 ft/s, the hydrodynamic torque developed in the valve shaft due to water flow across the disk becomes critical. Therefore, the flow velocity must be taken into account when selecting a butterfly valve and actuator. Disks are commonly lenticular (to about 25 ft/s) and lattice leaf (45 ft/s) for higher velocities. For emergency conditions, especially where there is a possibility of loss of power, the valves are often fitted with counterweights to close and with hydraulics to open. The valves can be sized up to 12 to 15 feet or more in diameter.

## 7.5 Jet-Flow Gate

The jet-flow gate is similar to a bonneted high pressure slide gate ([section 7.6](#)), but has a specially designed conical orifice that allows cavitation-free discharge for a wide range of gate openings. The orifice has a movable bronze seal ring that uses the water pressure to hold it in contact with the machined upstream face of the gate leaf. The gate is operated by a hydraulic hoist, or an electric motor-operator for smaller sizes. The upstream seal permits installation of the gate without embedment. Diameters of gates range from 6 to 96 inches with heads up to 700 feet. [Figure 96](#) shows an example of a jet-flow gate being fabricated, and [figure 97](#) shows a jet-flow gate during operation.

The discharge jet from a jet-flow gate is concentrated and well aerated, and can have considerable energy at stream impact. The coefficient of discharge (typically 0.8 to 0.84) is relatively high when compared to most other free-discharge gates. [Figures 98](#) and [99](#) and show jet-flow gates operating at partial and full openings, respectively.

### 7.5.1 Performance

The jet-flow gate is an excellent regulating gate that is virtually leak free. The circular orifice enables the gate to be installed without transitions and provides excellent discharge capabilities at small openings. The gate has no cavitation problems, and there are no operating restrictions for minimum openings. The gate can operate submerged with downstream modifications. These modifications include expanding



Figure 96.—Jet-flow gate



Figure 97.—Jet-flow gate in operation. Photo courtesy of URS Corporation.





Figure 98.—Jet-flow gate at partial opening. Photo courtesy of URS Corporation.



Figure 99.—Jet-flow gate at full opening. Photo courtesy of URS Corporation.

the downstream discharge pipe to three times the orifice diameter and keeping the discharge pipe very short to allow recirculation and prevent cavitation.

### 7.5.2 History

Reclamation developed jet-flow gates in the 1940s to regulate outlet works discharge at medium and high head dams. The first gates were used at Shasta Dam in 1946 and were called “discharge gates” (96-inch diameter gates using a dual screw type electric lift). Jet-flow gates have been used at many of Reclamation’s major dams, including Hoover Dam (68- and 90-inch diameter gates) (figure 100) and Theodore Roosevelt Dam (90-inch diameter gate). Hydraulically operated gates were first used in 1958 for the 84-inch diameter gate at Trinity Dam. Reclamation installed 68- and 90-inch diameter gates at Hoover Dam in 1997. The largest Reclamation gates are the 96-inch diameter gates at Shasta Dam, and the smallest gate is the 6-inch diameter gate at Batu Dam.

Jet-flow gates have several advantages and disadvantages. Advantages include:

- The discharge jet is well aerated, reducing the potential for cavitation.
- Operates at very small openings with no seat or seal erosion or potential for cavitation. The jet-flow gate has no minimum gate opening restriction.
- The jet-flow gate has a long and favorable performance history (e.g., the jet-flow gates installed at Shasta Dam have been operating since 1946).
- Jet-flow gates can be designed to operate for high head conditions. The 68- and 90-inch diameter jet-flow gates installed at Hoover Dam in 1997 are designed to operate at maximum heads of 610 and 435 feet, respectively (figure 100).
- Low spray allows operation in closer proximity to electrical equipment.

Disadvantages include:

- The overall height of the jet-flow gate is quite tall relative to its diameter, which is similar to gate valves or bonneted knife gates.
- Release from a jet-flow gate is a concentrated jet that can result in stream erosion and may require an energy dissipation structure or plunge pool.
- Although Reclamation has used the jet-flow gate primarily, this gate has not been widely used in the United States or internationally. Consequently, there are a limited number of jet-flow gate manufacturers.



Figure 100.—68- and 90-inch diameter jet-flow gates discharging. Photo courtesy of URS Corporation.

- Leakage in the closed position due to buildup of tolerances in the seal ring, clamp, and body.

Energy dissipators that can be considered for use with jet-flow gates include excavated plunge pools.

### 7.6 Bonneted Slide Gate and High Pressure Slide Gate

A bonneted slide gate consists of a gate frame and a moving disk or slide, which controls the opening under the disk to regulate the discharge (figure 101). The bonneted portion of the gate is a structure that encloses the disk when raised to the open position and allows for easier sealing of the disk and body. A motor-operated or hydraulic hoist mounted on top of the bonnet cover raises and lowers the gate leaf. The gate body and bonnet are designed to be embedded in concrete. The gate must have a round-to-square upstream transition and square-to-round downstream transition. Gates of cast-iron construction with design heads of less than 250 feet are called high pressure gates. Gates of fabricated steel construction with design heads greater than 250 are often called outlet gates.

#### 7.6.1 Performance

The bonneted slide gate is a common type of guard or regulating gate. The rectangular orifice provides straight line discharge capability. The gate has a history



Figure 101.—One half of a tandem bonneted gate system.

of cavitation problems, especially in the lower corners of the gate downstream body and bottom of the gate leaf. The gate has minimum opening requirements to prevent cavitation damage at small openings. Leakage past the gate is common, especially at the corners and the bottom sill.

### 7.6.2 History

Reclamation, USACE, and other major dam design agencies have commonly used bonneted and high pressure slide gates for regulating gates at medium and high head dams for more than 100 years. The bonneted gate was first used at Pathfinder Dam in 1906 (44- by 77-inch gates). These gates used a water-operated hydraulic hoist. These gates suffered severe cavitation damage, but adding adequate venting and tapering at the bottom of the leaf alleviated many of the problems. The largest Reclamation gates are the 9- by 12-foot gates at Twin Lakes Dam, and the smallest gates are the 2.75- by 2.75-foot gates at Stateline Dam. The highest head gates are the 3.5- by 4-foot gates at Morrow Point Dam at 355 feet of head.

Figure 102 shows a bonneted gate being fabricated. Bonneted slide gates for control of outlet works releases have been located at intake towers (a common USACE practice for nonpressurized outlet conduits through embankment dams), at gate chambers within the dam embankments (a common Reclamation practice), and in valve houses located at the downstream toe of dams. Refer to figure 1 (*Introduction*) for a schematic drawing showing alternative outlet works arrangements for guard and regulating gates.

Bonneted slide gates and high pressure slide gates have several advantages including:

- A relatively high coefficient of discharge ( $C_d = 0.86$  at fully opened).
- Durable gate design with little maintenance required.
- Long performance history.

Disadvantages include:

- Difficult to maintain because gates are typically encased in concrete, access to gate leaf is restricted, and removal for seat maintenance or leaf removal is difficult.
- High installation costs because the gates are heavy, require upstream and downstream transitions, and are usually embedded in concrete.
- Operation below the minimum allowable gate opening would result in cavitation damage.
- Minimum gate opening restrictions that are related to the bottom thickness of the leaf.
- High energy discharge from bonneted slide gates can cause erosion of stilling basins and plunge pools.
- Cavitation damage of the conduit sidewalls downstream of the gate leaf is a common maintenance problem.

Energy dissipators that can be considered for bonneted slide gates and high pressure slide gates include:

- Reclamation and USACE commonly use hydraulic jump stilling basins for bonneted gate installations for both horizontal entry and inclined entry to the basin.





Figure 102.—A fabricated (stainless steel) bonneted gate being produced for 200 feet of head. Photo courtesy of Rodney Hunt Corporation.

- A stilling basin at a concrete dam is shown on [figure 103](#). High pressure fluctuations can develop on the invert with this design. Sufficient anchorage and thickness of the floor slabs must therefore be provided to prevent their loss during high flows. Hydraulic model studies and experienced designers are required for design of high head, high discharge facilities.

### 7.7 Cast-Iron Slide Gate (Unbonneted)

Unbonneted slide gates function as a guard or regulating gate in outlet works, sluiceways, canals, turnouts, spillways, and intake towers. The unbonneted type slide gate ([figure 104](#)) has a rectangular or circular orifice with a vertically operated rectangular or circular leaf. The gate leaf is raised and lowered by a handwheel, electric-operated screw type lifts, or hydraulic cylinder. The gate frame is mounted on a headwall or pipe flange, and the gate leaf and stem are connected to the operating lift, which is mounted on a cross-beam on top of the frame guides or a



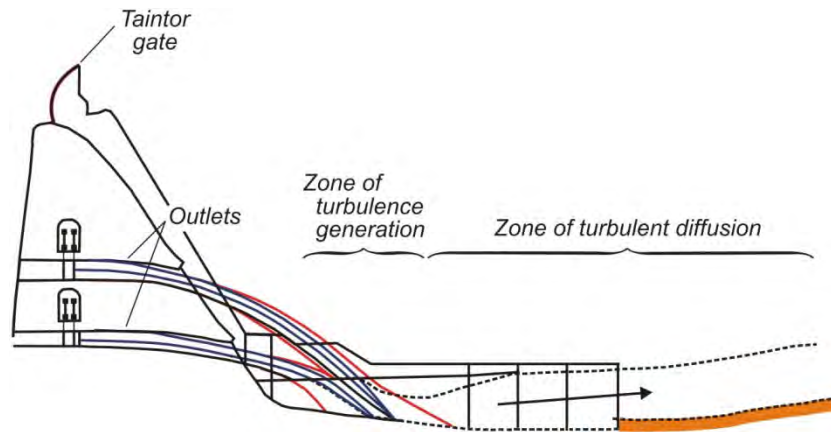

Figure 103.—Stilling basin for an outlet and spillway in a concrete dam.



Figure 104.—Unbonneted slide gate.

platform above the gate. The cast-iron slide gate consists of a cast-iron frame and disk or leaf, with bronze seats and guides. Wedging devices are provided to pull the disk against the seats in the closed position to reduce leakage. Cast-iron slide gates are commonly used to regulate flow on small, low head dams because of their relatively low cost, durable construction, low maintenance requirements, and commercial availability. Cast-iron slide gates are often used on large, medium head dams for upstream closure gates, guard or emergency gates, and multiple level inlet gates (these installations typically require the gates to be in the fully open or fully closed position). Commonly available sizes of gates range from 6 by 6 inches to 144 by 144 inches, with heads up to 100 feet. Shop assembly and testing of a cast-iron slide gate is shown in [figure 105](#).

### 7.7.1 Performance

Reclamation has used the cast-iron slide gate since its inception, and this gate has a long history of satisfactory performance. The only significant problem with the gates is the vulnerability of the exposed stems, which can be easily damaged by misoperation. Use of cast-iron slide gates for discharge regulation for heads in excess of 50 feet should be carefully considered, especially when required to operate at small gate openings.

### 7.7.2 History

The first cast-iron gates used by Reclamation were five 8- by 12-foot gates installed at Minidoka Dam in 1905. The largest Reclamation gates are the 11- by 14-foot gates installed at New Waddell Dam. Reclamation initially designed these gates, but they are now readily available from several commercial vendors.

Cast-iron slide gates have several advantages and disadvantages. Advantages include:

- Durable construction.
- Low maintenance requirements.
- Long and extensive history of satisfactory performance at dams. Cast-iron slide gates have been in operation for more than 100 years.
- Available in standard sizes.

Disadvantages include:

- Difficult to repair by welding.
- Not as resistant to cavitation damage as steel or stainless steel.



Figure 105.—Shop testing of cast-iron slide gate. Photo courtesy of Rodney Hunt Corporation.

- Head limitations for discharge control in the range of 50 feet. Cast-iron slide gates have been used to regulate at higher heads, but such use could result in gate cavitation damage and vibration.
- Minimum recommended gate opening restriction of approximately 10 percent.
- Higher leakage when used in the unseating direction.
- Where sediment load is significant, gates with cross beams (stiffeners) that are exposed to the reservoir tend to collect large quantities of sediment on them. This can result in jamming of the gate if left closed for prolonged periods.

Energy dissipators that can be considered for cast-iron slide gates are:

- Plunge pools.
- Hydraulic jump stilling basins.

## 7.8 Fabricated Slide Gate

A fabricated slide gate is similar in appearance and operation to the cast-iron slide gate, but the construction is quite different. A large, heavy duty fabricated slide gate installation is shown in [figure 106](#). A light duty slide gate is illustrated in [figure 107](#). Lighter duty fabricated slide gates use thinner members welded together, use synthetic rubber or ethylene propylene diene monomer (EPDM) seals instead of wedges, and often slide against low friction material instead of metal-to-metal seats. Fabricated slide gates can be made from carbon steel, stainless steel, aluminum, or composite. Fabricated slide gate applications are similar to those as previously discussed for cast-iron slide gates.

### 7.8.1 Performance

Though not as durable or rigid as the cast-iron gate, the fabricated slide gate does provide a good seal.



Figure 106.—Installation of large fabricated slide gates. Photo courtesy of Rodney Hunt Corporation.

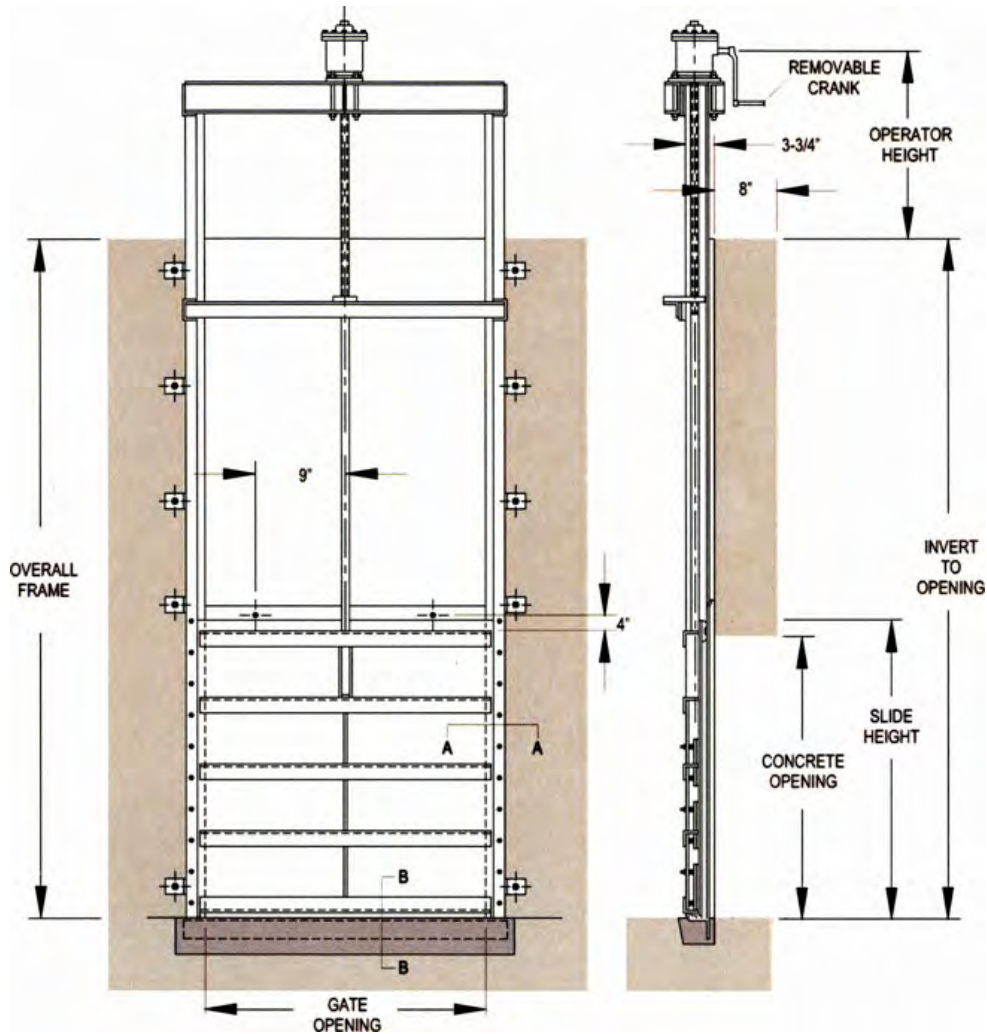

Figure 107.—Light-duty fabricated slide gate. Figure courtesy of Rodney Hunt Corporation.

### 7.8.2 History

Reclamation has used the fabricated slide gate since the mid-1960s, and this gate is commonly used for a variety of low to medium head applications throughout the world.

Advantages of fabricated slide gates include:

- Lower friction than cast-iron slide gates.
- More resistant to cavitation damage and corrosion (stainless steel).
- Lighter weight than cast-iron slide gates.



- Low leakage.
- More easily custom designed for unique applications.

Disadvantages include:

- Synthetic seals may require periodic replacement.
- Disadvantages similar to those discussed for cast-iron slide gates.

Energy dissipators that can be considered for fabricated slide gates include:

- Plunge pools.
- Hydraulic jump stilling basins.

### 7.9 Clamshell Gate

A clamshell gate functions as a regulating gate installed downstream of a guard or emergency gate in an outlet works. The clamshell gate (figure 108) is basically a pipe with the end radially cut from the horizontal centerline with two curved gate leaves



Figure 108.—48-inch diameter clamshell gate before installation.



on the downstream face that regulate the flow through the gate. The gate leaves have arms connecting them to trunnion pins on the gate body, and they each rotate in opposite directions from the centerline of the pipe to provide an opening for flow through the gate. The leaf arms are linked together such that the two leaves move in unison. The gate leaves are operated by a hydraulic cylinder attached to each leaf, or a gear-operated power screw attached to the arm linkage. Diameters of the gates range from 30 to 78 inches.

The clamshell gate is not a commonly manufactured gate and may not be available as part of a gate manufacturer's product line. An experienced designer may, therefore, have to design a new clamshell gate based on Reclamation design details. The gate's manufacture would have to be specifically for a given project. Refer to [figures 108](#) through [112](#) for examples of clamshell gates discharging flow.

### 7.9.1 Performance

The clamshell gate is a very good regulating gate with an extremely high discharge coefficient and the capability of both free and submerged discharge. There are no operating restrictions on gate openings, but the gate does not perform well regulating small discharges. The gate does not experience cavitation while operating in both free and submerged discharge.



Figure 109.—68-inch diameter clamshell gate at 100-percent open.



Figure 110.—Ten clamshell gates operating fully open.



Figure 111.—Clamshell gates operating under 50 feet of submergence. No air was entrained during submerged discharge.



Figure 112.—78-inch diameter clamshell gate used for evacuation of a siphon.

### 7.9.2 History

A Reclamation engineer (Tom Isbestor) developed the clamshell gate in 1976. The first clamshell gate was used at Grassy Lake Dam in 1989 (30-inch diameter). The largest clamshell gate was installed at Salt River Siphon (78-inch diameter).

Clamshell gates have several advantages including:

- Relatively simple design.
- Low cavitation potential.
- Can pass debris with minimal potential for restriction when compared to all other valves and gates.
- May be used for high head installations.
- Can discharge under water.
- No air requirements for cavitation prevention.
- Largest discharge coefficient of all regulating valves and gates,  $C_d = 0.99$  to  $1.00$ .

Disadvantages include:

- Downstream channel erosion due to concentrated jet.

- Design not available commercially.
- Poor flow control at small openings.
- Ice can build up on exposed leaf arms due to spray.

Historical problems with clamshell gates are:

- Erosion downstream of the valve because of the concentrated jet and low head loss through the gate ([figure 112](#)).
- Difficult to develop effective horizontal seal between the two clamshell leaves. The major difficulty has been in a “drip-tight” seal. To accomplish this, the lip seals have been modified to allow an overlap that expands from the internal pressure. The circumferential seals have been somewhat problematic and can experience damage by pinching.

An energy dissipator that can be considered for clamshell gates is the plunge pool.

### 7.10 Top-Seal Radial Gate

A top-seal radial gate is a regulating gate occasionally used in an outlet works. The top-seal radial gate design (Reclamation) and submerged tainter gate (USACE) are similar to the design of a surface radial gate, using a curved skin plate leaf structure supported by radial arm columns extending to trunnions. The addition of a seal along the top between the skin plate and headwall structure, in addition to the side and bottom seals, allows the gate to be used in low level outlets. With the top seal in place, water only flows under the gate, which controls discharge by raising or lowering the gate. A hydraulic hoist can operate this gate. A top-seal radial gate is shown in [figure 113](#).

Larger gates may have counterweights mounted on the arms, which are extended beyond the pin bearing. Sizes of the gates range in widths up to 50 feet and heights up to 64 feet.

#### 7.10.1 Performance

Top-seal radial gates are used for making large releases from medium to high head facilities. The discharge pattern and energy dissipation requirements of the top-seal radial gate are similar to those of a slide gate. However, the hydraulic approach conditions to the top-seal radial gate at throttled openings are more streamlined and favorable than for the fixed-wheel gate or slide gate. Top-seal radial gates must be designed to eliminate flow-induced vibration since there is little damping of the gate movement.



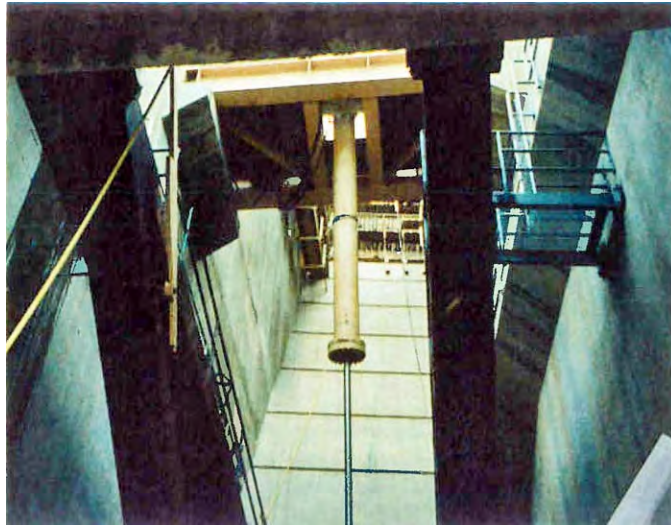

(a)

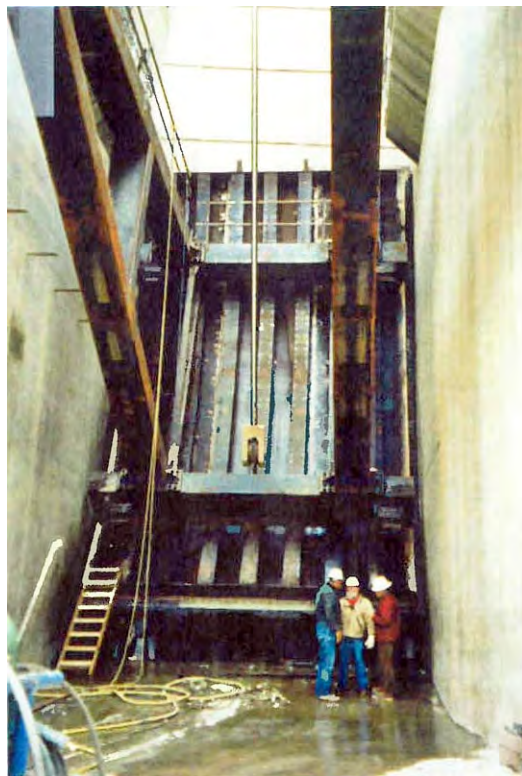

(b)

**Figure 113.**—Installation of 21-foot wide by 30-foot high top-seal radial gates (design head 132 feet). Gates are located at the upstream end of waterways. (a) Upward view of hoist support beam assembly. (b) Downstream view of radial gate leaf and arm assembly. Gate trunnions (not shown) are mounted on downstream headwalls.

### 7.10.2 History

The first top seal radial gates were installed in the 1930s. Radial gates have been used for many installations at spillways, canal check structures, and canal turnouts.

Advantages of top seal radial gates include:

- The top-seal radial gates have been used at high head installations with heads exceeding 250 feet.
- Can be used for large outlet gate sizes.
- Long history of successful use.
- Commercially available, but requires specialized design and manufacturing experience.
- High discharge coefficient,  $C_d = 0.95$ .
- The operating hoist can be relatively small (in relation to gate size) due to low friction.

Disadvantages include:

- Flow-induced vibrations can be a problem if the gate or structure is not properly designed.
- Jamming of the gate in open or closed position has been a problem. Jamming is a critical issue because of large size and discharge capacity.
- Cavitation damage can occur downstream of the gate and discharge structure.
- Requires a large structure due to radial arm configuration.
- Model testing may be recommended for final design.
- Access for maintenance can be difficult.
- Usually not suitable for control of low flows because of the wide gate width.
- Excessive leakage can occur; therefore, special attention to seal design and installation is critical.



Energy dissipators that can be considered for top-seal radial gates include:

- Flip buckets.
- Hydraulic jump stilling basins.
- Plunge pools.

### 7.11 Fixed-Wheel Gate

A fixed-wheel gate (also known as a wheel-mounted gate) functions as a guard gate for penstocks and outlet works. Fixed-wheel gates are usually used where large, high head gates are required and where emergency closure is needed without available power. They are similar in design to slide gates, but are mounted on wheels to reduce operating friction. The gates can be constructed larger than slide gates because of the lower operating friction, which reduces operating force requirements.

The fixed-wheel gate ([figure 114](#)) consists of a flat, structural steel gate leaf with steel wheels on each side of the downstream end of the gate. The gate travels on rails installed in the gate slot and is typically operated by a gantry crane or hydraulic hoist with multiple stem segments. Fixed-wheel gates are often installed on the upstream face of a dam or powerplant.

#### 7.11.1 Performance

The fixed-wheel gate is the only type of high head gate that can close unassisted (under its own weight) under unbalanced head and seal on the upstream side of the gate leaf. These gates are ideal for powerplants where they can shut off flow through a penstock during power outages. The gate requires regular maintenance to the wheel bearings. Fixed-wheel gates are more commonly used as guard or emergency gates, but are occasionally used for flow regulation at low and medium head installations with large discharge requirements. Fixed-wheel gates must be carefully designed for flow regulation to eliminate flow-induced vibration since the low friction rolling action of the wheel support arrangement provides minimal damping to gate movement (when compared to the high slide gate friction).

#### 7.11.2 History

The first Reclamation fixed-wheel gates installed were the 16.8- by 19.6-foot gates at American Falls Dam in 1925. Reclamation's largest gates are the 29.0- by 43.5-foot gates installed at Grand Coulee Dam Third Powerplant.



Figure 114.—Fixed-wheel gate measuring 16 feet wide by 26 feet high. Photo courtesy of Rodney Hunt Corporation.

Advantages of fixed-wheel gates include:

- May be used for large gate openings.
- Commercially available, but require specialized design and manufacture.
- Long history of use for spillways and outlet works for dams.
- Can close under gravity with no power, an ideal operating characteristic for an emergency gate.
- The operating hoist can be relatively small due to low friction.
- Ability to seal on the upstream side of the gate leaf.

Disadvantages include:

- Vibration may be a problem, especially at small gate openings.

## Outlet Works Energy Dissipators

---

- Rubber seals may require frequent replacement and maintenance.
- Large gates require massive structural members.
- Massive superstructure required to house lifting machinery. An overhead gantry or mobile crane is often required for lifting and servicing gates.
- Periodic wheel inspection and wheel maintenance.
- Installation can be difficult because the tracks and frame require critical alignment to achieve smooth operation and effective sealing.
- Roller trains are susceptible to corrosion buildup of deposits that increase friction and interfere with operation of the rollers and links.

Energy dissipators that can be considered for fixed-wheel gates include:

- Hydraulic jump stilling basins.
- Flip buckets.
- Plunge pools.

## Chapter 8

# Sudden Enlargements and Inline Orifices

Sudden expansions and inline orifices represent a practical, economical, low maintenance means of dissipating energy in pressurized systems. Energy can be dissipated in multiple, manageable steps, or head drops, along the length of a conduit (figure 115). The probable cavitation that occurs with the sudden large head drops is mitigated by a combination of expansion geometry and suppression from the backpressure that is accumulated in the upstream direction. If designed properly, cavitation will occur safely in the interior of the conduit expansion zone, so that the internal conduit lining is left intact.

Primary applications include low level outlet works and passive outflow systems. Some of the most notable applications have been the use of large diameter diversion tunnels during original dam construction for low level outlet works.

Since no single design method for these hydraulically complex systems is universally accepted, experienced hydraulic engineers should supervise designs, and/or designs should be accompanied by application of physical or computational fluid dynamics (CFD) modeling. In addition to past research and design efforts, this chapter presents one comprehensive methodology that has proved reliable. The appendix provides additional design commentary. Future investigations into sudden enlargements using applications of CFD modeling are recommended.

### 8.1 General

There are basically three different types of applications for flow control:

- *Upstream gate or valve control.*—Sudden enlargement systems are located downstream of control valves or gates to provide both backpressure and reduction in velocity to protect the valve or gate from cavitation damage during operation.

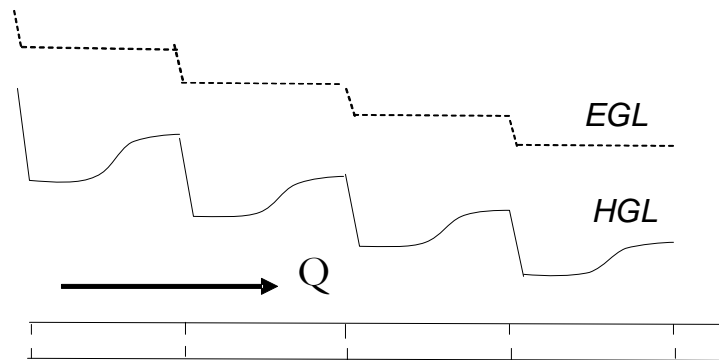

Figure 115.—Total energy (EGL) and hydraulic (HGL) gradelines in an inline orifice system.

- *Downstream valve or gate control.*—Sudden enlargement systems are located upstream of a valve or gate to reduce flow rate, velocities, and dynamic load at the valve or gate.
- *Passive on/off control.*—Flow is passively controlled as a function of head in the system with sudden enlargements. An on/off valve or gate can be included.

The advantages of systems with sudden enlargements or inline orifices include:

- Reduces flow, velocities, and dynamic load at control valves or gates.
- Most effective at low level outlets where backpressure can be utilized to suppress the potential for cavitation.
- Low maintenance.
- Highly effective passive control systems for applications such as outlet works or powerhouse bypasses.

The limitations of systems with sudden enlargements or inline orifices include:

- There is no reduction in static head on control valves or gates with the use of these systems. A system of sudden enlargements or inline orifices requires discharge to dissipate energy. Consequently, the control valve or gate has no beneficial reduction in head difference from a system of sudden enlargements or orifices when the valve or gate is barely cracked open or closed.
- These systems are much less effective when applied in steeply sloped conduits. Much of the benefit from these systems is derived from the ability to build backpressure in the upstream direction to suppress the potential for cavitation.

- These systems require some minimum length to accommodate the required number of head drops. Depending on the magnitude of total head drop and discharge, there will be some minimum number of steps or head drops with a minimum length between steps.
- The range of flow control is limited.

## 8.2 Basic Considerations

The application of sudden enlargements or inline orifices (figure 116) has been regarded as an effective and economical means of energy dissipation. A significant amount of research on the use of sudden expansion and inline orifice has been conducted since 1960 (Ball and Simmons, 1963; Russell and Ball, 1967; Ball, Tullis, and Stripling, 1975; Tullis, 1989; Zhang and Cai, 1999).

As a high velocity jet is released into a sudden expansion or an orifice, energy is dissipated from viscous shear within the fluid body of the expanded downstream conduit surrounding the jet. As explained by Russell and Ball (1967, p. 43):

When there is a sudden enlargement, intense eddy action is set up by shearing action between the incoming high velocity jet and the surrounding water, and a general eddy forms as the surrounding water is entrained by the jet. Much of the kinetic energy of the jet is dissipated by the eddy action, but most of the turbulence disappears and the velocity practically becomes uniform across the cross-section of the enlarged pipe at a distance of about 5 diameters from the enlargement. Rapid pressure fluctuations of substantial magnitude accompany the energy dissipation.

Figure 117 illustrates the Russell and Ball description.

The uniform flow (about five diameters downstream) described by Russell and Ball (1967) is often called the “fully developed flow” zone. The surrounding large eddy around the vena contra is often referred to as the “flow separation” zone. If there is a choking (or supercavitation) condition through an orifice or valve, the location where the flow resumes fully developed will be pushed much farther downstream (beyond the typical five diameters), and the flow separation zone will become a vapor cavity.

The time-dependent pressures caused by turbulence, or the creation and decay of eddies, are a significant part of the cavitation process (Tullis, 1989). Cavitation often starts off the tip of the orifices and extends into the interior of the expansion conduit (section 8.3.1). The key is to avoid cavitation that will cause damage to the lining of the conduit.

The Seven Oaks Dam case history in the appendix discusses an inline orifice design.





Figure 116.—Looking upstream at inline orifices within a 36-inch outside diameter pipe.

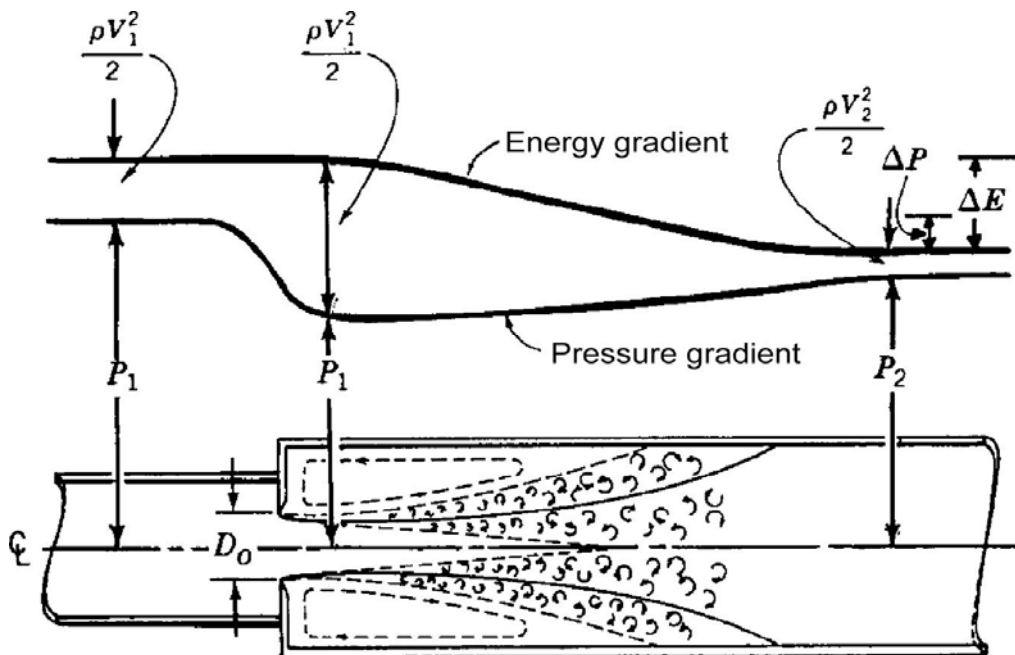

Figure 117.—Typical flow patterns and hydraulic variables in sudden expansion or inline orifice (Tullis, 1989).

### 8.2.1 Head loss, pressure, and velocity considerations

The head loss ( $HL$ ) (or energy loss  $[\Delta E]$ ) created by a sudden expansion or inline orifice is the difference in total head (just) upstream and downstream (where fully developed flow has resumed) minus the pipe friction loss in the expansion zone (figure 117):

$$HL = \left( Z_1 + \frac{P_1}{\gamma} + \frac{V_1^2}{2g} \right) - \left( Z_2 + \frac{P_2}{\gamma} + \frac{V_2^2}{2g} \right) - \left( \frac{fL}{D_2} \right) \left( \frac{V_2^2}{2g} \right) \quad \text{eq. 13}$$

where:

$HL$  = head loss generated by a sudden expansion or inline orifice (ft)

$Z$  = centerline elevation (ft)

$P$  = pressure (lb/ft<sup>2</sup>)

$V$  = average velocity in pipeline (ft/s)

$\gamma$  = unit weight of water (lb/ft<sup>3</sup>)

$g$  = acceleration due to gravity (32.2 ft/s<sup>2</sup>)

$f$  = Darcy-Weisbach conduit friction coefficient

$L$  = length of conduit between locations 1 and 2 (ft)

$D_2$  = hydraulic diameter of downstream conduit (ft)

Subscript 1 refers to location upstream of the sudden expansion or inline orifice.

Subscript 2 refers to location downstream of the sudden expansion or inline orifice after flow is fully developed.<sup>1</sup>

The first and second terms in equation 13 are the total head at locations 1 and 2, respectively. The third term is the friction loss estimate.

#### 8.2.1.1 Dimension and velocity of jet entering sudden enlargement

There are essentially two different types of sudden enlargements regarding the parameters of the jet entering the downstream expansion area (figure 118):

- Sudden enlargements without jet contraction (see figure 118a for two examples)
- Sudden enlargements with jet contraction (see figure 118b for an example)

<sup>1</sup> The ratio of inside pipe diameters for which the downstream measurement was made to obtain the pressure head in the fully developed flow zone has varied between different research projects: 4.9, 9.3, and 12 diameters for Ball and Simmons (1963), 6 to 12 diameters for Russell and Ball (1967), and 10 diameters for Ball, Tullis, and Stripling (1975) and Tullis (1989). Since the pipe friction loss is low in comparison to expansion loss, the differences are relatively minimal. Tullis (1989) recommended deducting the estimated friction loss from the total loss.

(a) Sudden enlargements without jet contraction  
(NC-Sudden enlargements)

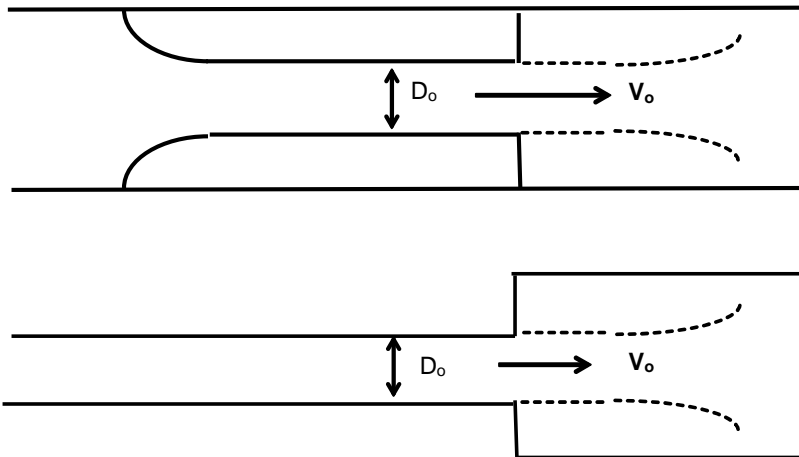

(b) Sudden enlargement with jet contraction  
(Inline orifice)

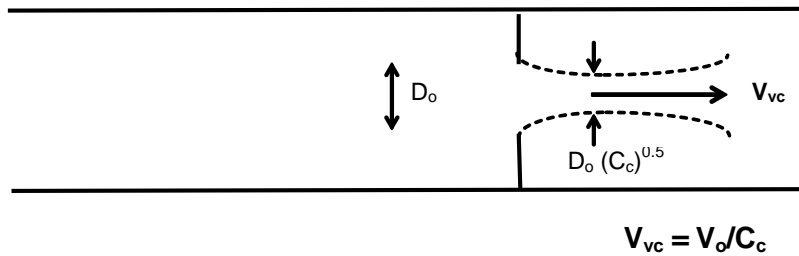

Figure 118.—Types of jets entering expansion areas in sudden enlargements: (a) no jet contraction; (b) with jet contraction.

### 8.2.1.2 Sudden enlargements without jet contraction

Upon release into the expansion area, the jet diameter does not contract nor does the jet accelerate. The upstream diameter approaching the release point is uniform without any protrusions to create a contraction of the jet (figure 118a).

Since the jet diameter ultimately spreads and fills the pipe in the downstream direction, the maximum velocity of the jet within the expansion zone is computed by:

$$V_o = \frac{Q}{(0.25\pi D_o^2)} \quad \text{eq. 14}$$

where,

$Q$  = flow rate (ft<sup>3</sup>/s)

$V_o$  = velocity of jet upstream of sudden expansion (ft/s)

$D_o$  = inside diameter of approach conduit upstream of expansion zone (ft)

With no contraction of the jet, the head loss for a sudden expansion can be approximated by the Borda equation (Russell and Ball, 1967):

$$HL = \frac{(V_o - V_2)^2}{2g} \quad \text{eq. 15}$$

$HL$  = head loss from sudden expansion (ft)

$V_o$  = velocity of jet upstream of sudden expansion (ft/s)

$V_2$  = velocity of fully developed flow in downstream expansion zone conduit (ft/s)

$g$  = acceleration due to gravity (32.2 ft/s<sup>2</sup>)

$$V_2 = \frac{Q}{(0.25\pi D_2^2)} \quad \text{eq. 15a}$$

$Q$  = flow rate (ft<sup>3</sup>/s)

$D_2$  = inside diameter of conduit in expansion zone, or downstream of sudden expansion (ft)

### 8.2.1.3 Sudden enlargements with jet contraction (inline orifices)

With inline orifices, a jet contraction in the form of a vena contracta occurs about 1 to 2 orifice diameters downstream of the orifice (figure 118b). The maximum velocity of the orifice vena contracta is given by the following:

$$V_v = \frac{Q}{A_v} \quad \text{eq. 16}$$

where,

$V_v$  = vena contracta velocity (ft/s)

$Q$  = flow rate (ft<sup>3</sup>/s)

$A_v$  = flow area of vena contracta

$$A_v = C_c \cdot 0.25 \cdot \pi \cdot D_o^2 \text{ (ft}^2\text{)}$$

$C_c$  = contraction coefficient

$D_o$  = orifice diameter (ft)

The contraction coefficients for sharp edged orifices are a function of the ratio of the orifice opening diameter ( $D_o$ ) to inside diameter of the approach pipeline ( $D$ ). Contraction coefficients are provided in figure 14.2 of Miller (1978) and can be approximated ( $R^2 = 0.999$ ) by the following equation:

$$C_c = 3.1341 \cdot \theta^5 - 5.8809 \cdot \theta^4 + 3.8307 \cdot \theta^3 - 0.879 \cdot \theta^2 + 0.1851 \cdot \theta + 0.61 \quad \text{eq. 17}$$

where,

$\theta$  = ratio of areas for inline orifice and inside diameter of pipe ( $D$ )

$$\theta = \left( \frac{D_o}{D_1} \right)^2 ; \theta = \{0 \dots 1\} \quad \text{eq. 17a}$$

$D_o$  = orifice diameter (ft)

$D_1$  = inside diameter of pipe upstream of orifice (ft)

The lowest average pressure will be at the vena contracta location. The difference between the upstream and vena contracta pressures (or pressure heads) is henceforth referred to as the orifice pressure (or head drop). This pressure drop is used to measure discharge rates in orifice meters. Or, conversely with a known discharge coefficient and discharge rate, the pressure in the vena contracta area can be determined. Applying the head drop, the orifice discharge rate can be measured or determined from the following equation:

$$Q = CD_0 \cdot A_o \cdot \sqrt{2g \cdot \left( \frac{P_1}{\gamma} - \frac{P_{vc}}{\gamma} \right)} \quad \text{eq. 18}$$

where,

$Q$  = flow rate ( $\text{ft}^3/\text{s}$ )

$CD_0$  = discharge coefficient for orifice meter

$A_o$  = orifice area =  $0.25 \cdot \pi \cdot D_o^2$

$D_o$  = orifice diameter (ft)

$$\text{Head drop}^2 = \left( \frac{P_1}{\gamma} - \frac{P_{vc}}{\gamma} \right)$$

$P_1$  = pressure upstream of orifice ( $\text{lb}/\text{ft}^2$ )

$P_{vc}$  = pressure in the vena contracta zone (0.5 to 1.5 diameters downstream of orifice) ( $\text{lb}/\text{ft}^2$ )

$\gamma$  = specific weight of water

The vena contracta pressure ( $P_{vc}$ ) must be greater than or equal to vapor pressure. One way to check is to apply equation 18 for a known  $Q$ ,  $CD_0$ , and  $P_1$ ; or apply contraction coefficient terms (equations 16 and 17) to estimate the pressure:

---

<sup>2</sup> If the orifice is free discharging into the atmosphere, then  $P_{vc} \leq 0$  (gauge pressure).

$$P_w = P_1 - \rho \cdot \left( \frac{V_1^2 - V_w^2}{2} \right) \quad \text{eq. 19}$$

where,

- $P_w$  = vena contracta pressure (lb/ft<sup>2</sup>)
- $P_1$  = pressure upstream of orifice (lb/ft<sup>2</sup>)
- $\rho$  = density of water (lb-s<sup>2</sup>/ft<sup>4</sup>)
- $V_1$  = velocity upstream of orifice (ft/s)
- $V_w$  = vena contracta velocity (ft/s)

If  $P_w \leq$  vapor pressure, choking cavitation should be assumed, and Q should be recomputed from [equation 18](#) based on  $P_w =$  vapor pressure.

The discharge coefficient ( $CD_0$ ) for an orifice meter can be estimated from the contraction coefficient ( $C_c$ , provided previously in [equation 17](#)) (referred to as “flow coefficient  $K$ ” by [Crowe, Elgar, and Roberson \(2001, pp. 595–596\)](#) instead of  $CD_0$  as shown in eq. 20):

$$CD_0 = \frac{C_c \cdot C_v}{\sqrt{1 - C_c^2 \cdot \frac{A_o^2}{A_1^2}}} \quad \text{eq. 20}$$

where,

- $CD_0$  = discharge coefficient for orifice meter
- $C_v$  = coefficient of velocity related to Reynolds number (0.98 for Reynolds number  $> 10^5$ )
- $A_1$  = inside area of main pipe upstream of the orifice (ft<sup>2</sup>)
- $A_1 = 0.25 \cdot \pi \cdot D_1^2$  eq. 20a
- $D_1$  = inside diameter of pipe upstream of orifice (ft)

Laboratory-measured discharge coefficients in pressurized inline orifice systems may be as much as 4 percent lower than [equation 20](#) ([Ball and Simmons, 1963](#)).<sup>3</sup>

The orifice head or pressure drop should not be confused with orifice head loss. Moving downstream of the vena contracta, the flow separation zone diminishes as the full flow zone expands to fill the entire pipe within about five pipe diameters

<sup>3</sup> However, the actual discharge coefficient data measured in [Ball and Simmons \(1963\)](#) ([figure 6](#) for downstream pressures measured 0.7 diameters below orifice) matched [equation 20](#) within  $\pm 1.5\%$ .



downstream of the orifice. For all cases, the relationship between head loss ( $HL$ ) and orifice loss coefficient ( $K_o$ ) is the following:

$$HL = \left( \frac{Q}{A_p} \right)^2 \left( \frac{K_o}{2g} \right) \quad \text{eq. 21}$$

where,

$$\begin{aligned} HL &= \text{head loss across orifice (ft)} \\ Q &= \text{flow rate (ft}^3/\text{s)} \\ A_p &= \text{area of pipe (ft}^2\text{)} \\ K_o &= \text{orifice loss coefficient applied to main pipe area (}A_2\text{)} \\ A_2 &= 0.25\pi D_2^2 \\ D_2 &= \text{inside diameter of downstream conduit (ft)} \\ g &= \text{acceleration due to gravity (32.2 ft/s}^2\text{)} \end{aligned} \quad \text{eq. 22}$$

The head loss coefficient for sharp edged orifice can be estimated from the following empirical equation (Rahmeyer, 1988) or obtained from figure 14.3 of Miller (1978):

$$K_o = 4,890e^{(-10.18\beta)} \quad \text{eq. 23}$$

where,

$$\begin{aligned} K_o &= \text{head loss coefficient} \\ \beta &= \text{ratio of orifice to pipe diameter} \\ \beta &= \frac{D_o}{D_2} \\ D_o &= \text{orifice diameter (ft)} \\ D_2 &= \text{inside diameter of downstream conduit (ft)} \end{aligned} \quad \text{eq. 23a}$$

The Rahmeyer equation (23) is valid only for orifice ratios ( $0.3 < D_o/D < 0.8$ ); use figure 14.3 from Miller (1978) when orifice ratios are not between 0.3 and 0.8 (Note: the term for the X-axis of figure 14.3 is incorrectly inverted; it should read “Orifice or free area” / “Total Cross-sectional Area”). The Rahmeyer equation also assumes that the inside diameter of upstream and downstream conduit are equal ( $D_1 = D_2$ ). If they are not equal ( $D_1 \neq D_2$ ), a refinement of Miller’s (1978) equation 14.3 would apply:

$$K_o = \left( 1 - \left( \frac{D_o}{D_2} \right)^2 \cdot C_c \right)^2 \cdot \frac{1}{\left( \frac{D_o}{D_2} \right)^4 \cdot C_c^2} \quad \text{eq. 24}$$

where,

$K_0$  = head loss coefficient

$D_o$  = orifice diameter (ft)

$D_2$  = inside diameter of downstream conduit (ft)

$C_c$  = contraction coefficient from [equation 17](#) based on  $\theta$  as function of  $(D_o/D_1)$ .

$D_1$  = inside diameter of pipe upstream of conduit (ft)

With [equation 24](#), the vena contracta jet is based on upstream geometry; whereas the downstream full flow velocity is based on the downstream conduit size where the energy is dissipated. Equation 24 will also work for  $D_1 = D_2$ , however, [equation 23](#) is a more accurate predictor of orifice head loss.

The orifice head loss coefficient can be reduced by rounding of the orifice edge (figure 14.4 of [Miller \[1978\]](#)):

$$K_o = C_{rad} * K_o \text{ (for sharp edged orifice)} \quad \text{eq. 25}$$

where,

$K_0$  = head loss coefficient

$C_{rad}$  = function of radius of orifice edge ( $r$ ) to orifice diameter ( $D_o$ )

$C_{rad}$  can be regressed from the following equation:

$$C_{rad} = -49.913 \left( \frac{r}{D_o} \right)^3 + 27.117 \left( \frac{r}{D_o} \right)^2 - 5.1893 \left( \frac{r}{D_o} \right) + 1.00 \quad \text{eq. 25a}$$

where,

$r$  = radius of orifice edge (ft)

$D_o$  = orifice diameter (ft)

The head loss coefficients tend to breakdown as conditions approach choking cavitation.

### 8.2.2 Type of enlargements and orifices and effects on energy dissipation

[Russell and Ball \(1967\)](#) pioneered a large scale, low level outlet works using flow expansions in three tunnels at [Mica Dam \(case history in appendix\)](#). After several iterations, their best result was to have the three concentric tunnels release outlet jets directed toward the center of the main expansion conduit at about a 5- to 10-degree angle (see section CC in [figure 119](#)). Mica Dam required three separate tunnels for more precise flow control. In essence, the three concentric converging jets replicate flow patterns in a vena contracta of a single inline orifice centered in the main pipe.

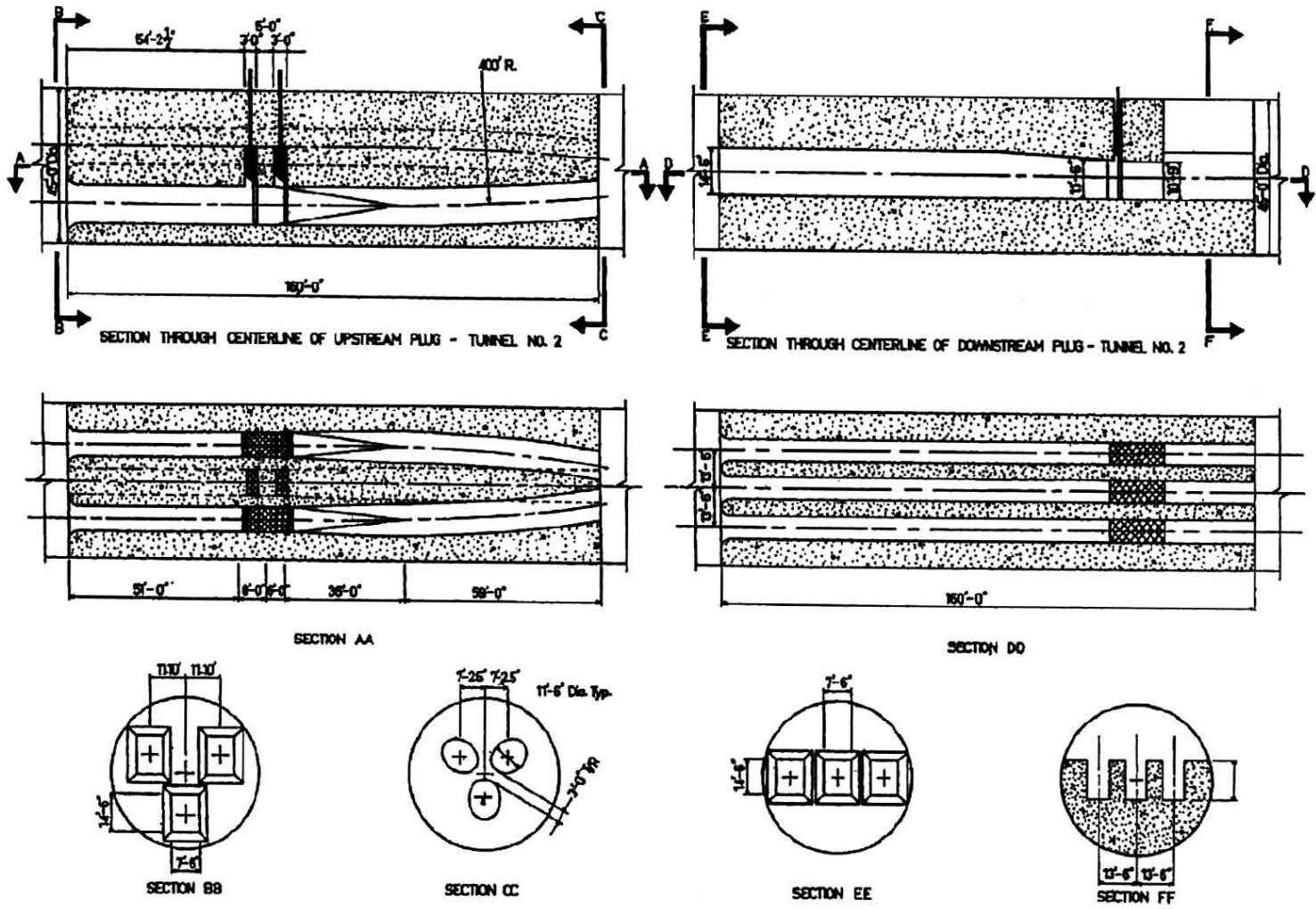

Figure 119.—Design schematic of Mica Dam (Russell and Ball, 1967).

Sharp edged, single opening orifices are the most typical application elsewhere and the object of most research. Sharp edged, single opening orifices were used at another large scale outlet work project, Xiaolangdi Hydraulic Project ([figure 120](#)), in China ([Zhang and Cai, 1999](#); [Cai, Feng, and Zhang, 2000](#)). The [Xiaolangdi project case history](#) is included in the appendix. Additional case histories involving inline orifices ([Pineview](#) and [Seven Oaks Dams](#)) are also included in the appendix.

The advantages of centered, sharp crest orifices include:

- Efficient energy dissipation.
- A simplicity that allows for durable structural design.
- A long history of research and applications and a large body of supporting data available for design applications.
- A low likelihood of debris plugging.

Disadvantages include:

- The conduit length required to safely accomplish energy dissipation and heavy vibrations or potential cavitation damage if designed improperly.

Sharp edged orifices should be constructed of steel for durability and cavitation resistance. Velocities that create equivalent cavitation damage in concrete are 1.7 times higher with standard carbon steel. Stainless steel is the most resistant where the velocities for equivalent cavitation damage are 2.0 times higher than the velocities for concrete ([Reclamation, 1990b](#)). Depending on the intended life of the project, stainless steel or carbon steel is recommended for the orifice material. If stainless steel orifices are installed in standard carbon steel pipelines, care must be taken to keep these materials separated to avoid metal incompatibility and corrosion issues.

[Tullis \(1989\)](#) addressed the advantages and disadvantages of multi-holed orifice plates. Advantages include:

- Less noise and vibration.
- Orifice plates can be spaced closer together (if done in series).
- Cavitation damage (if it occurs) happens within a shorter distance from the orifice plate.

The key disadvantage is that these are more prone to plugging from suspended debris.

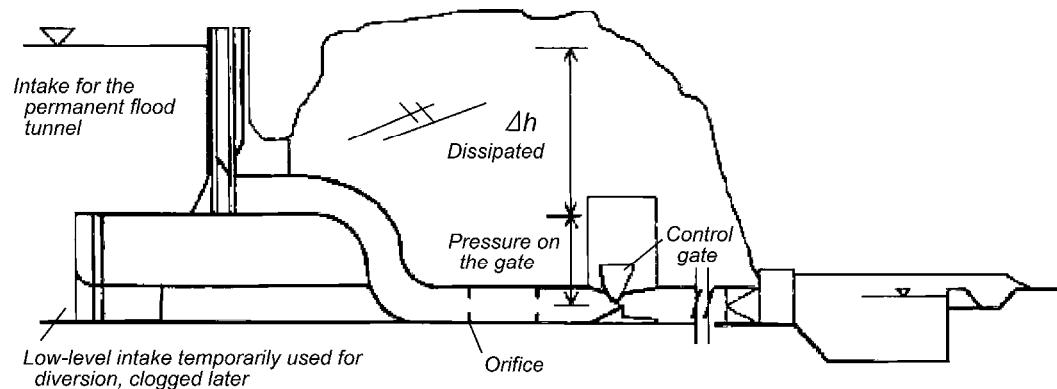

Figure 120.—Design concept of Xiaolangdi Hydraulic Project on the Yellow River, China (Zhang and Cai, 1999).

Sleeve valves are an application of multi-holed orifices in which the energy is dissipated by having the small jets directed inwardly toward each other into an impact zone in the center of the conduit. Sleeve valves are discussed in [section 7.2](#).

Zhang and Cai (1999) investigated alternate orifice configurations to reduce the energy loss coefficients, velocities, and cavitation potential in locations with lower backpressure, such as near the downstream end of the system. Alternative orifice shapes are shown in [figure 121](#) (Item b is the standard ASME sharp edged orifice, and item c is the type of sharp edged orifice used at the [Xiaolangdi Hydraulic Project](#)); a case history is provided in the appendix. For an orifice diameter ratio ( $\beta = D_o/D$ ) of 0.69, the pressure drop downstream of the orifice could be reduced by between 10 percent for the rounded edge orifice to over 50 percent for sloped and curved edge orifices. At the same time, the head loss coefficients were also reduced by a factor of about 2.5. Results varied for different orifice ratios (Zhang and Cai, 1999). Ball and Simmons (1963) investigated a combination butterfly valve opening to a sudden expansion downstream.

### 8.2.3 Cavitation and its prevention

Cavitation is defined as the change in state from liquid to vapor caused by hydrodynamic processes. Large pressure waves and noise accompany the subsequent change in state from a vapor to a liquid (Reclamation, 1990b). The abrupt collapse of vapor bubbles occurs when they move into a zone of higher pressure. The collapse of a vapor bubble near a surface creates local micro jets of extremely high velocities and potential damage (Reclamation, 1990b). When these cavitation processes occur near a surface of a structure, valve, or pipe wall, pitting can occur. Flow obstructions in a high velocity flow field are one example of a hydrodynamic process that causes a local acceleration and a corresponding pressure drop in the immediate vicinity, potentially leading to damage downstream of the obstruction where the bubbles collapse. Popping or pinging noises are associated

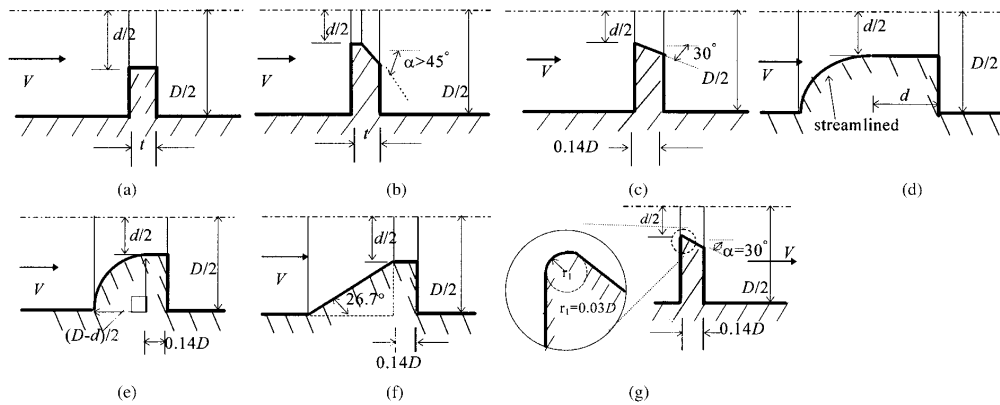

Figure 121.—Alternative orifice configurations (figure 2 from Zhang and Cai, 1999).

with light cavitation, and extreme cavitation events have been known to create noise levels high enough to drive operators out of valve pits.

Cavitation coefficients ( $\sigma$ ) are used to assess the degree or severity of cavitation at a specific location. The lower the value, the higher the cavitation potential. The dimensionless cavitation coefficients used for different forms (Ball, Tullis, and Stripling, 1975; Tullis, 1989) are:

$$\sigma = \frac{H_d - H_v}{H_u - H_d} \text{ or } \sigma = \frac{P_2 - P_v}{P_1 - P_2} \text{ (from figure 117)} \quad \text{eq. 26}$$

where:

- $\sigma$  = dimensionless system cavitation coefficient (for orifice)
- $H_d$  = pressure head downstream of orifice after full flow recovery ( $P_2/\gamma$  from figure 117)
- $H_v$  = vapor pressure head =  $P_{vg}/\gamma$  ( $P_g$  = vapor pressure)
- $H_u$  = pressure head upstream of orifice ( $P_1/\gamma$  from figure 117)
- $P_2$  = pressure downstream (lb/ft<sup>2</sup>)
- $P_v$  = absolute vapor pressure (lb/ft<sup>2</sup>)
- $P_1$  = pressure upstream (lb/ft<sup>2</sup>)
- $D$  = main pipe inside diameter ( $D = D_2$ ) (ft)
- $D_2$  = hydraulic diameter of downstream conduit (ft)

The pressure or pressure head parameters must be applied consistently using either absolute or gauge pressure:

- Absolute pressure:

1.  $P_i$  = gauge pressure ( $P_{ig}$ ) + barometric pressure ( $P_b$ )



2.  $P_v$  = absolute vapor pressure

- Gauge pressure:

1.  $P_{ig}$  = gauge pressure

2.  $P_{vg}$  = gauge vapor pressure =  $P_v - P_b$

Cavitation levels for the sudden expansion have been categorized in an ascending order of severity (Ball, Tullis, and Stripling, 1975; Tullis, 1989). The cavitation damage parameters were developed using 0.5-inch soft aluminum strips within 3-inch diameter pipelines (Ball, Tullis, and Stripling, 1975). Aluminum experiences equivalent cavitation damage at velocities 1.5 times greater than for concrete (Reclamation, 1990b), so the following cavitation parameters are conservative for steel conduits and slightly risky for concrete:

- *Incipient cavitation* ( $\sigma_i$ ).—Cavitation level where noise is initially (barely) detected and is recommended for design requirements where noise is not tolerated. This would be a very conservative design and could lead to overdesign of a steel conduit. However, in concrete-lined expansion conduits, the design cavitation coefficients should not be allowed to go below this level, and a moderate factor of safety may be desired (e.g., Russell and Ball [1967] used a design cavitation coefficient of 3.0, whereas the incipient citation for the design configuration was 2.5).
- *Critical cavitation* ( $\sigma_{cr}$ ).—Cavitation where light, steady noise is similar to the sound of “frying bacon.” Damage is either nonexistent or so minimal that there is no long term threat (in steel conduits). Vibrations are negligible, and noise is usually unobjectionable. This is a safe design level for steel conduits.
- *Incipient damage cavitation* ( $\sigma_{id}$ ).—Cavitation is raised to level where pitting can be observed in the walls. Noise may be objectionable, but damage is minor and should not represent a threat over time. This may be an acceptable design level in large steel conduit systems; as noted by Tullis (1989), the cavitation parameters are developed in small pipelines and represent conservative values as the scale of the conduit is increased.
- *Choking cavitation* ( $\sigma_{ch}$ ).—This is the condition where the average pressure just below the orifice falls to vapor pressure. Holding a constant upstream pressure or head, if the pressure or head is decreased on the downstream side, flow does not subsequently increase. The flow is being choked through the orifice because the downstream pressure cannot drop below vapor pressure. The head loss coefficients ( $K_o$ ) shown previously will no longer apply because they assume full pressure recovery and no limitation to the pressure drop below the orifice. If the system is already in a choking condition and the upstream pressure head

or flow is increased, the size of the vapor cavity is simply enlarged, and the zone of pressure recovery and cavitation damage is moved downstream. No system should be operated at or near choking; otherwise, severe cavitation damage will result in the downstream conduit. Operating just below the choking threshold must also be avoided because systems experience maximum vibrations in this condition.

### 8.3 Design Criteria and Guidance

#### 8.3.1 Cavitation

##### 8.3.1.1 The Tullis method of cavitation analysis

Tullis (1989) assembled design guidance and system of equations, representing a comprehensive methodology, from a body of research largely developed at Colorado State University to assess the probable level of cavitation activity associated with a given inline orifice design and flow condition. This methodology draws from past research (e.g., Ball and Simmons, 1963; Ball, Tullis, and Stripling, 1975) with a shared understanding that researchers have long recognized that scale effects occurred in the physical modeling of cavitation. The assumption and application of scale effects are not universally accepted. However, these methods effectively predicted the cavitation levels (observed sounds) in the inline orifice system at Seven Oaks Dam.

The previous cavitation coefficients are determined as a function of orifice diameter ratio ( $\beta$ ) and discharge coefficient ( $CD$ ) (Tullis, 1989):

$$CD = 0.019 + 0.083\beta - 0.203\beta^2 + 1.35\beta^3 \quad \text{eq. 27}$$

$CD$  = discharge coefficient based on area of pipe ( $A_p$ )

$\beta$  = orifice diameter ratio (eq. 23a)

where: 
$$CD = \frac{Q}{A_p \sqrt{2g(H_1 - H_2)}}$$

$CD$  is related to  $K_o$  (defined in eq. 27) by:

$$CD = \frac{1}{\sqrt{K_o + 1}} \quad \text{eq. 28}$$

where,

$Q$  = flow rate ( $\text{ft}^3/\text{s}$ )

$A_p$  = area of pipe ( $\text{ft}^2$ )

$g$  = acceleration due to gravity (32.2 ft/s<sup>2</sup>)  
 $H_1$  = pressure head upstream (lb/ft)  
 $H_2$  = pressure head downstream (lb/ft)

By the Tullis method, incipient cavitation ( $\sigma_i$ ) is:

$$\sigma_i = \sigma_{im} SSE \quad \text{eq. 29}$$

where,

$\sigma_{im}$  = reference incipient cavitation coefficient from lab tests (Tullis, 1989)  

$$\sigma_{im} = 0.62 + 4.4CD + 6.6CD^2 + 1.3CD^3 \quad \text{eq. 30}$$

$SSE$  = size scale effect from reference lab results to prototype scale

$$SSE = \left( \frac{D_p}{D_m} \right)^Y \quad \text{eq. 31}$$

$D_p$  = diameter of prototype pipe  
 $D_m$  = diameter of pipes tested in lab  
 $D_m$  = 3 inches (Tullis, 1989)

$$Y = 0.3(K_o)^{-0.25} = 0.3 \left( \frac{1}{CD^2} - 1 \right)^{-0.25} \quad \text{eq. 32}$$

The Tullis method determines critical cavitation ( $\sigma_{cr}$ ) as:

$$\sigma_{cr} = \sigma_{cm} SSE \quad \text{eq. 33}$$

where,

$\sigma_{cm}$  = reference critical cavitation coefficient from lab tests (Tullis, 1989)<sup>4</sup>  

$$\sigma_{cm} = 0.78 + 0.77CD + 8.9CD^2 + -4.16CD^3 \quad \text{eq. 34}$$

$SSE$  = size scale effect from reference lab results to prototype scale (provided in eqs. 31 and 32)

By the Tullis method, incipient damage cavitation ( $\sigma_{id}$ ) is:

$$\sigma_{id} = \sigma_{idm} PSE \quad \text{eq. 35}$$

---

<sup>4</sup> Equations for  $\sigma_{cm}$  and  $\sigma_{id}$  provided in Tullis (1989) were in error and were corrected, based on the data from Tullis (1989) and Ball, Tullis, and Stripling (1975), for presentation in this manual.

where,

$$\sigma_{idm} = \text{reference incipient damage cavitation coefficient from lab tests (Tullis, 1989)}^4$$

$$\sigma_{idm} = 0.11 + 6.5CD - 7.9CD^2 + 8.8CD^3 \quad \text{eq. 36}$$

$PSE$  = pressure scale effect from reference lab results to prototype scale

$$PSE = \left( \frac{P_1 - P_{vg}}{P_{1m} - P_{vgm}} \right)^{0.19} \quad \text{eq. 37}$$

$P_1$  = prototype gauge pressure upstream of sudden enlargement

$P_{vg}$  = prototype gauge vapor pressure at prototype scale

$$P_{vg} = P_v - P_b$$

$P_v$  = absolute vapor pressure (function of water temperature)

$P_b$  = barometric pressure

$P_{1m}$  = model upstream pressure = 90 lb/in<sup>2</sup>

$P_{vgm}$  = model gauge vapor pressure = -12.2 90 lb/in<sup>2</sup>

Choking cavitation ( $\sigma_{ch}$ ) (no size or pressure scale effects) by the Tullis method is:

$$\sigma_{ch} = 0.15 + 1.2CD - 0.31CD^2 + 3.3CD^3 \quad \text{eq. 38}$$

### 8.3.1.2 Alternative methods of cavitation analyses

Because there is some disagreement in the cavitation field about the validity of scale effects, a senior reviewer on the panel for this manual recommends alternative guidance by applying orifice cavitation data that do not involve scale effects based on research conducted by [Zhang and Chai \(2001\)](#).

[Zhang and Chai \(2001\)](#) investigated head loss coefficients and incipient cavitation for a five-orifice series system using orifices with rounded edges ranging 0.75 to 2.25 inches (prototype) or edge radius/conduit diameter ( $D$ ) ratios of (0.11 to 0.0033), see [figure 121g](#) for shape. The prototype conduit diameter was 48 feet, and the design head was 260 feet. The orifice/diameter ratios were varied between 0.62 and 0.82. The study was conducted in a 1:60 scale model where the model pipe diameter was 9.5 inches. The design intent was to avoid cavitation altogether and, incipient cavitation was identified as “. . . the occurrence of three to five cavitation bubbles in one minute and the fluctuation of high frequency noise energy with time downstream of the orifice” ([Zhang and Chai, 2001](#)). Incipient cavitation indices from the 1:60 model are presented in [figure 9 \(p. 667\) of the Zhang and Chai reference](#) as a function of orifice/conduit diameter ratio and orifice edge radius.

The research by [Zhang and Chai \(2001\)](#) is noteworthy because it represents the only investigations of inline orifices in which model investigations in a cavitation tunnel

were compared to prototype observations. They made the following significant findings:

- Cavitation inception in the prototype can be predicted using extrapolations of empirical curves developed in a scale model. The curves are values of incipient cavitation index as a function of the Reynolds number. A size scale effect parameter is not required to scale model values to prototype magnitudes.
- The use of hydrophones that have a high frequency response can render the detection of cavitation inception objective. This technique is superior to subjective methods using aural or visual observations.
- Cavitation inception with orifices depends highly upon the upstream flow conditions. Even the upstream curvature of a tunnel influences cavitation inception at downstream orifices.
- The incipient cavitation index for several inline orifices decreases in the downstream direction. Stated in other words, the cavitation intensity becomes greater for each succeeding orifice, even if they all have the same diameter.
- Analytic predictions of the characteristics of inline orifices based on the characteristics of tests with a single orifice are not accurate because of the interactions noted above.
- The maximum energy loss of the inline orifice energy dissipator is obtained when the spacing between inline orifices is equal to  $3D$ , where  $D$  is the conduit diameter.
- A physical model is essential in developing an inline orifice energy dissipator. Preferably, the model tests should be conducted in a vacuum test chamber.

Other notable past research that did not consider scale effects include [Numachi, Yamabe, and Oba \(1960\)](#); and [Ball and Simmons \(1963\)](#). [Numachi, Yamabe, and Oba \(1960\)](#) conducted tests in 4.1-inch diameter pipes with orifice ratios ( $D_o/D$ ) between 0.224 and 0.593. Cavitation was identified and categorized primarily by visual observations, except where large vibrations and noise were noted. [Ball and Simmons \(1963\)](#)<sup>5</sup> ran head loss and cavitation tests in 3-inch diameter pipes with orifice ratios between 0.407 and 0.774. They also tracked the changes in pressure at different intervals ( $L/D$ ) downstream of the orifice and observed pressure fluctuations in the vena contracta region. Like [Tullis \(1989\)](#), cavitation was identified by audible observations, and pressure fluctuations in the flow separation zone were also recorded.

---

<sup>5</sup> While no scale effects were addressed here, J.W. Ball later collaborated with Tullis in an initial attempt to address scale effects in [Ball, Tullis, and Stripling \(1975\)](#).

On February 23, 2005, the USACE collected pressure data and field observations for cavitation noise during prototype flow tests in a 35.35-inch diameter conduit inline orifice system at Seven Oaks Dam (approximate discharge rate of 120 ft<sup>3</sup>/s). See the [Seven Oaks Dam case history](#) in the appendix for a complete description, recorded pressure data, and cavitation data comparison with respect to [Tullis \(1989\)](#). The Tullis method predicted the observed prototype field conditions at Seven Oaks accurately and with reasonable conservatism.

### 8.3.2 Distance between series of inline orifices

If conduit length is not a constraint, there is no disadvantage to having orifices spaced beyond what is required to attain fully developed flow. However, if space is at a premium, the minimum difference required to accomplish either fully developed flow or the needed energy dissipation should be applied. The danger of spacing too tightly is that too much of the high velocity core of the jet will simply pass through the next orifice with little energy dissipation benefit. More importantly, that second orifice would also be subjected to higher vibrations due the higher pressure fluctuations upstream of the full flow development zone. For these reasons, [Ball and Simmons \(1963\)](#) recommended a distance of 5 (expansion zone) pipe diameters between orifices based on pressure recovery data in their tests. [Tullis \(1989\)](#) recommended 6 to 10 diameters to attain fully developed flow. [Cai, Feng, and Zhang \(2000\)](#) recommended a shorter distance of three (expansion zone) pipe diameters as the most economical design and that would accomplish most of the potential energy dissipation. Their tests were done with between 2 and 5 orifices in series, all with an orifice diameter ratio of 0.69.

### 8.3.3 Energy loss computations for sudden expansion and inline orifices

[Equation 14](#) should be applied for all energy dissipation. To obtain the appropriate loss coefficient ( $K_e$ ) for the different expansion configurations:

- Use the Borda equation ([eq. 15](#)) for sudden expansions without contractions.
- Obtain  $CD$  from either [equation 20](#) or [equation 27](#), and obtain  $K_e$  from [equation 24](#).
- Other expansion geometries require additional research.
- Recommend large scale physical and/or numerical modeling for large scale applications.

Include estimated head losses through valves or gates, plus conduit friction and minor losses associated with the conduit in the development of the energy gradeline for the system.



### 8.3.4 Considerations for downstream orifices or sudden enlargements

At the downstream sections of an inline or sudden-enlargement energy-dissipating system, the orifices or enlargements are most susceptible to cavitation since backpressures are at their lowest in these areas. Some strategies to avoid dangerous cavitation levels in these areas include:

- Install an air vent at most downstream orifices or sudden enlargements (A more constricting orifice or sudden enlargement could then be used).
- Transition the head drops more gradually at the downstream end (requires more orifices or sudden enlargements).
- Raise backpressures by either:
  1. Ensuring sufficient tailwater levels at all operations.
  2. Installing the downstream section of conduit at greater depth to cause submerged discharge into tailwater or upwell.
  3. Using vertical slide gate or tainter valve at outlet to raise backpressures (special air demand considerations are required for the valves).
  4. Operationally raising tailwater levels during interim system usages.
- Avoid installing the downstream section of energy dissipation system on steep downward gradient.
- Investigate using rounded edge orifices.

### 8.4 Design Guidance for Sudden Enlargements and Inline Orifices

The following design guidance should be used in designing an inline orifice system:

- Establish design (maximum) flow rate and head difference across the system.
  1. Establish design forebay and tailwater levels.
- If the system requires valve or gate control, select a location.
  1. If a valve or gate is located downstream of a series of orifices:
    - a. Determine the maximum acceptable head drop across the valve at design flow.

- b. Determine the maximum allowable upstream dynamic head on the gate.
    - c. Determine the intended range of flow control. Note the maximum design flow rate.
  2. If a valve or gate is located upstream of a series of orifices:
    - a. Determine the maximum acceptable head drop across the valve at design flow.
    - b. Determine the intended range of flow control. Note the maximum design flow rate.
    - c. Determine the minimum acceptable head or pressure downstream of the gate.
    - d. Determine an acceptable means of transition from pressurized conduit to open channel flow (e.g., impact type energy dissipator).
- Determine the size of the expansion conduit based on:
  1. Whether an existing low level conduit, such as a diversion tunnel, is available.
  2. An acceptable conduit size for sufficiently low average velocities approaching the downstream gate or energy dissipation transition.
- For orifice system design:
  1. Determine the design level of cavitation (e.g., incipient cavitation [ $\sigma_i$ ], critical [ $\sigma_c$ ], or incipient damage [ $\sigma_{id}$ ] or some interpolation between). For example, the Seven Oaks Dam steel conduit design used maximum design parameters halfway between  $\sigma_{cr}$  and  $\sigma_{id}$ ; and the Mica Dam concrete tunnel used design values more than 2 times above incipient cavitation ( $\sigma_i$ ) computed from equivalent area ratios.

As scale goes up, design cavitation levels should be able to rise and approach incipient damage ( $\sigma_{id}$ ) in steel conduits.
  2. Establish downstream head and pressures at design conditions.

3. Establish an upstream target head or energy gradeline; this is either:
  - a. The design forebay elevation.
  - b. The minimum acceptable head downstream of the valve or gate during design conditions.
4. Starting from the downstream end (where backpressures are lowest), knowing the size of the expansion conduit, determine the minimum orifice diameter ratio that may be applied without violating the cavitation criteria.
  - a. Select the orifice size (or orifice/pipe ratio) and compute the system or field cavitation index from [equation 26](#). The downstream pressure ( $P_2$  or  $H_d$ ), vapor pressure, and barometric pressure are known. The denominator in [equation 26](#) is determined by the orifice head loss, computed by [equation 21](#) at maximum design discharge rate. Use [equation 23](#) or [25](#) or the combination of [equations 27](#) and [28](#) to obtain orifice loss coefficient  $K_o$ . For noncontracting, sudden expansions, use [equations 15](#) and [21](#).
  - b. Apply size and pressure scale factors, as appropriate, from referenced data ([equations 27](#) through [37](#), depending on the cavitation level used). Determine  $\sigma$ -criteria from the applied scale effects (e.g., if the acceptable design level is midway between critical cavitation ( $\sigma_c$ ) and incipient damage cavitation ( $\sigma_{id}$ ) (adjusted for size and pressure scale effects, respectively), then  $\sigma$ -criteria =  $0.5 * (\sigma_c + \sigma_{id})$ ).
  - c. Determine the amount of energy loss that can be attained at the maximum acceptable design cavitation level. It is acceptable if  $\sigma$ -system (step 4.a.)  $\geq$   $\sigma$ -criteria. If  $\sigma$ -system  $\gg$   $\sigma$ -criteria, consider reducing orifice size (return to step 4.a.). If  $\sigma$ -system  $<$   $\sigma$ -criteria, the orifice should be enlarged (return to step 4.a.).
  - d. Add in conduit friction and other minor losses and calculate the energy gradeline.
  - e. If the energy gradeline matches or exceeds target head, stop.
5. Proceed to the next upstream orifice and repeat the previous steps to determine the energy gradeline upstream of the orifice.

Repeat as needed until the energy gradeline matches or exceeds the target head.

6. If there is a considerable surplus of head at the upstream end, one of the following actions is recommended:
    - a. Conduct a second iteration in which the cavitation criteria are red (less aggressive) and provide better energy dissipation balance.
    - b. Consider reducing the expansion conduit diameter.
    - c. Consider reducing the number of orifices by slightly expanding the expansion conduit.
  7. If there is a deficit in the target head and the available conduit length has been exhausted by the number of orifices, then either:
    - a. Enlarge the expansion zone conduit size and reiterate.
    - b. Consider reducing the design flow rate.
- Check the system design at minimum and median flow rates to ensure system will perform acceptably at the range of design flow rates.

All hydraulic tools (large scaled physical modeling, CFD, and prototype field data) should continue to be used to explore, verify and/or alter the guidance and scale effects presented in this chapter. If CFD were used, care would be needed in ensuring adequate cell resolution both around the defining geometry and in the downstream regions to capture transient pressures that might predict probable cavitation.



## Chapter 9

# Riprap and Concrete Blocks

Riprap is a rock lining material that has long been used to protect against the erosive forces of water. Properly designed riprap used in an energy dissipator can provide long-term erosion protection and may be an economic alternative to a concrete stilling basin. This chapter includes discussion of both riprap and concrete blocks used in conjunction with energy dissipators, and transitional riprap structures at the exit of stilling basins and other energy dissipators. [Chapter 4](#) provides design guidance for a riprap-lined plunge basin and will not be discussed in this chapter.

### 9.1 Riprap

Several publications and laboratory models describe the use of riprap or riprap aprons at the conduit outfalls. These were primarily developed for storm drain outfalls and storm water management ponds. They have been applied to small dams (with drainage areas less than one square mile) typically where the conduit diameter is less than or equal to 60 inches, where flow velocities are less than 20 ft/s, and for Froude numbers less than 2.5.

#### 9.1.1 Riprap aprons

The riprap apron is one of the most common forms of outlet protection on small dams. The riprap apron is typically a flared transition constructed at zero grade for a distance downstream that is related to the conduit diameter. Although the riprap apron provides relatively little energy dissipation, it can provide very effective erosion protection at the conduit outlet by armoring the turbulent transition area. The key design parameters of the riprap apron are apron length, apron width, riprap thickness, and riprap size. [Figure 122](#) shows a riprap apron downstream from a conduit exit portal.





Figure 122.—A riprap apron used for erosion protection.

### 9.1.1.1 New York and Maryland design guidance

The erosion and sediment control manuals of the States of New York and Maryland ([New York State Department of Environmental Conservation, 2005](#); [Maryland Department of the Environment, 1994](#)) provide guidance for the design of riprap aprons below storm drains and small dam outfalls and to determine the size and length of riprap needed. The standard shape of the aprons is 3D wide (D equals the equivalent conduit diameter or the partial depth of flow for unsubmerged conduits) at the outfall and expands on a 2:1 side slope for tailwater depths below 0.5D, or a 5:1 side slope for tailwater depths greater than 0.5D. Note that the size of stone is significantly smaller for higher tailwater depths.

### 9.1.1.2 HEC-14 design guidance

[FHWA's Hydrologic Engineering Circular HEC No. 14 \(HEC-14\)](#) provides a design method for riprap aprons. This publication covers many dissipator designs including riprap. The riprap research was done by Fletcher and Grace in 1972 at the U.S. Army Engineers Waterway Experimental Station in Vicksburg, Mississippi. The required size of riprap ( $D_{50}$ ) is developed as a function of discharge, conduit diameter, and the tailwater depth.

$$D_{50} = 0.2D \left( \frac{Q}{\sqrt{g}D^{2.5}} \right)^{4/3} \left( \frac{D}{TW} \right) \quad \text{eq. 39}$$

where,

- $D_{50}$  = riprap size (ft)
- $Q$  = design discharge (ft<sup>3</sup>/s)
- $g$  = acceleration due to gravity, 32.2 ft/s<sup>2</sup>
- $D$  = conduit diameter (circular) (ft)
- $TW$  = tailwater depth (ft)

Tailwater depth for equation 39 should be limited to between 0.4  $D$  and 1.0  $D$ . If tailwater is unknown, use 0.4  $D$ .

Whenever the flow is supercritical in the conduit, the conduit diameter is adjusted as follows:

$$D' = \left( \frac{D + y_n}{2} \right) \quad \text{eq. 40}$$

where,

- $D'$  = adjusted conduit rise (ft)
- $D$  = conduit diameter (ft)
- $y_n$  = normal (supercritical) depth in the conduit (ft)

The computed  $D_{50}$  is used in conjunction with the conduit diameter to determine the appropriate basin dimensions (table 5).

Table 5.—Example riprap apron dimensions

$D_{50}$ (in)	Apron length*	Apron depth
5	4 <i>D</i>	3.5 <i>D</i> <sub>50</sub>
6	4 <i>D</i>	3.3 <i>D</i> <sub>50</sub>
10	5 <i>D</i>	2.4 <i>D</i> <sub>50</sub>
14	6 <i>D</i>	2.2 <i>D</i> <sub>50</sub>
20	7 <i>D</i>	2.0 <i>D</i> <sub>50</sub>
22	8 <i>D</i>	2.0 <i>D</i> <sub>50</sub>

\*  $D$  is the conduit rise.

This design method assumes that the rock specific gravity is 2.65. If the actual specific gravity differs from 2.65, the recommended  $D_{50}$  should be adjusted by the ratio of the 2.65 and the actual specific gravity.

The following summarizes the [Fletcher and Grace Study \(1972\)](#):

- Empirical equations were developed for depth, width, and length of scour based on discharge, conduit diameter, and duration of flow.
- Empirical equations were developed for riprap size and length of riprap dissipator based on discharge, diameter of conduit, and tailwater depth.
- Other erosion protection lining materials were investigated including concrete blocks and concrete sacks.
- Empirical equations were developed for size and length of dissipators using concrete blocks and concrete sacks based on discharge, thickness of blocks or sacks, and tailwater depth.
- Level riprap aprons dissipate energy by increased roughness and expanding or spreading flow from a conduit outfall over a short distance. The distance of the riprap apron typically ranges from 4 to 8 times the conduit diameter.
- The results show that a horizontal apron requires a larger riprap size and longer length than a preformed lined scour hole or lined plunge pool.
- The relative advantage of providing both vertical and lateral expansion downstream of an outlet may result in considerable reduction in stone size, if a preformed scour hole is provided in lieu of a horizontal blanket.
- With a preformed scour hole, the discharge plunges into a pool of water and dissipates energy more quickly than a level riprap apron.
- The equations developed for riprap sizes are restricted to tailwater depths equal to or less than the conduit diameter in the report.

The tailwater depth affects the width and length of the riprap apron. [Figures 5B.13 and 5B.14](#) in the [New York Standards and Specifications for Rock Outlet Protection \(New York State Department of Environmental Conservation, 2005\)](#) show the effect of discharge, velocity, and conduit diameter on the size and length of a riprap apron required. For tailwater depths less than half the conduit diameter, a much longer and narrower riprap apron is required.

### 9.1.1.3 Boulder County storm drainage design guidance

The *Boulder County Storm Drainage Criteria Manual* (WRC Engineering, 1984) provides alternative guidance for riprap apron design. This publication utilizes a thicker riprap section immediately downstream from the outlet to assure that there is adequate protection in this highly erosive zone.

The riprap size and length predictor equations found in the *Boulder County Storm Drainage Design Manual* were developed by [Simons, Stephens, and Watts \(1971\)](#). Their work included 288 model tests on riprap basins for circular and rectangular culverts at Colorado State University. The riprap size equation is very similar to the Fletcher and Grace Equation with the same predictor variables of discharge, conduit diameter, and tailwater depth. However, the length of the dissipator was not only based on discharge and conduit diameter, but also on the angle of expansion of the flow jet coming out of the conduit, and the allowable downstream nonerosive velocity. The length of the dissipator is a minimum of 3 times the conduit diameter, but no larger than 10 times the conduit diameter.

The following summarizes the [Simons, Stephens, and Watts study \(1971\)](#):

- Valid for Froude numbers up to 2.5.
- The minimum riprap dissipator was 3 times the conduit diameter, but no larger than 10 times the conduit diameter.
- Can be used for multiple conduits.
- No dissipator width is given in the study.
- The first half of the dissipator requires a thicker blanket of stone.
- The dissipator does not expand, but appears to conform to the downstream channel dimensions.

### 9.1.2 Riprap basins

HEC-14 provides design criteria for riprap basins based upon research conducted at Colorado State University. The basin dimensions and riprap size ( $D_{50}$ ) are developed as a function of the Froude number, tailwater depth, and the equivalent depth at the basin entrance (see [chapter 6](#)). The riprap basin is very similar in concept to the plunge pool basin ([chapter 4](#)), but is limited to applications where there is little or no vertical drop from the conduit invert to the downstream channel. [Figures 123 and 124](#) show a half plan and profile of a riprap basin.

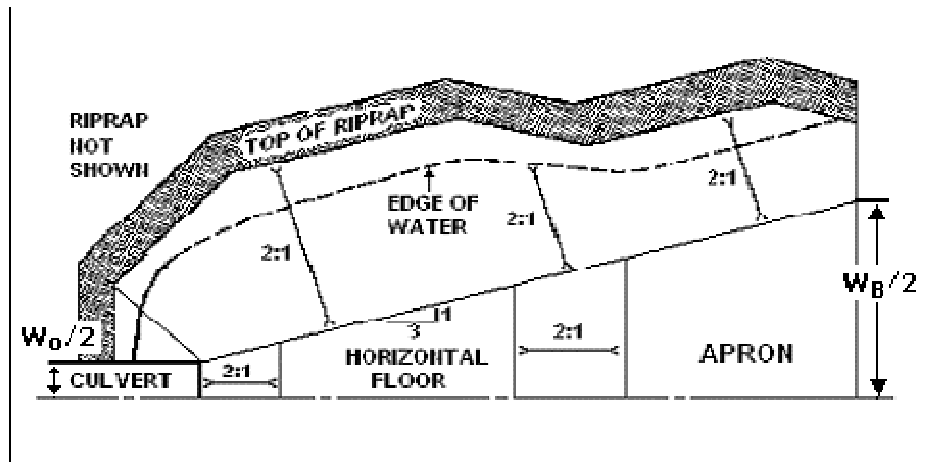

Figure 123.—Half plan of riprap basin (FHWA, 2006, p. 10-2). See FHWA (2006) for information concerning the variables as denoted in this figure.

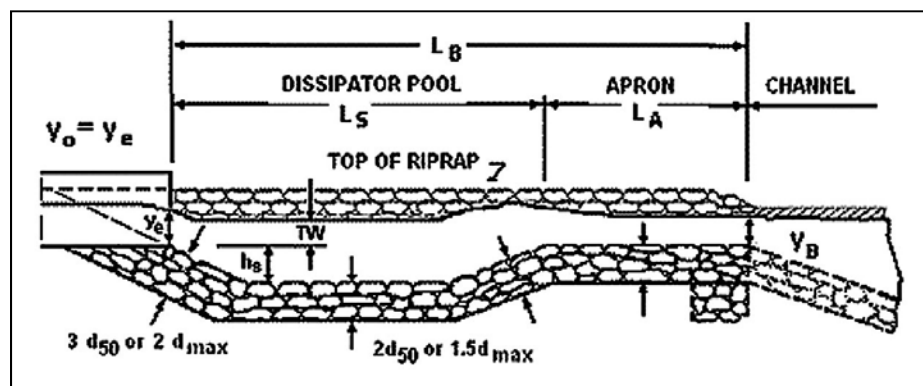

Figure 124.—Profile of a riprap basin (FHWA, 2006, p. 10-1). See FHWA (2006) for information concerning the variables as denoted in this figure.

To balance the need for avoiding an undersized basin against the costs of oversizing a basin, an envelope design relationship in the form of equations 41 and 42 was developed.

$$\frac{h_i}{y_e} = 0.86 \left( \frac{d_{50}}{y_e} \right)^{-0.55} \left( \frac{V_o}{\sqrt{g y_e}} \right) - C_o \quad \text{eq. 41}$$

where,

- $h_i$  = dissipator pool depth (ft)
- $y_e$  = equivalent brink (outlet) depth (ft)
- $d_{50}$  = median rock size by weight (ft)
- $V_o$  = conduit outlet velocity (ft/s)
- $g$  = acceleration due to gravity (32.2 ft/s<sup>2</sup>)
- $C_o$  = tailwater parameter

The tailwater parameter,  $C_o$ , is defined as:

$$\begin{array}{ll} C_o = 1.4 & TW/y_e < 0.75 \\ C_o = 4.0(TW/y_e) - 1.6 & 0.75 < TW/y_e < 1.0 \\ C_o = 2.4 & 1.0 < TW/y_e \end{array} \quad \text{eq. 42}$$

TW = tailwater depth (ft)

- $b_s/d_{50} > 2.0$
- $L_s = 10 b_s$ ;  $L_s \geq 3W_0$   $L_s$ , dissipator length (ft);  $W_0$ , diameter of conduit (ft)
- $L_{A} = 5 b_s$ ;  $L_{A} \geq W_0$   $L_{A}$ , apron length (ft)
- $W_B = W_0 + 2(L_B/3)$   $W_B$ , basin width at d/s end (ft);  $L_B$ , basin length (ft)
- Cutoff wall may be optionally installed to protect against channel degradation.

The following conclusions follow from the model studies used to develop the HEC-14 riprap basin design guidance:

- For a given riprap basin configuration, the basin depth ( $b_s$ ) and the riprap size ( $d_{50}$ ) are the two primary variables that the designer may select. The required riprap size will decrease as the basin depth increases.
- Rounded stone was found to perform approximately the same as angular stone.
- The basin functions best as an energy dissipator for low tailwater conditions ( $TW/y_0 < 0.75$ ) where  $y_0$  is the brink depth. For higher tailwater conditions, the modeled scour holes were shallower and longer.
- Material movement may result in a scour mound at the downstream end of the basin. The scour mound will increase the effective basin depth and improve the energy dissipation within the basin—it should generally not be removed.

## 9.2 Transitional Riprap Aprons Downstream of Energy Dissipators

Riprap should be provided at the transition immediately downstream of a concrete energy dissipator to prevent scour at the end of the structure (figure 125). Riprap is also used for lining channel banks to prevent lateral erosion, if there is evidence of downstream channel erosion. The riprap apron can also be used to gradually expand or contract flow to converge with the natural channel.





Figure 125.—Transitional riprap apron downstream for a type VI stilling basin to prevent scour.

### 9.2.1 Application

Transitional riprap aprons are necessary downstream of concrete energy dissipator basins if the flow velocity exceeds the allowable erosive stream velocity. Transitional protection is also recommended if there is an abrupt change in cross-sectional flow area between the concrete energy dissipator and the downstream channel that may result in the development of erosive eddies.

### 9.2.2 Transitional riprap design below SAF stilling basins

Rice and Kadavy recognized the need for transitional riprap aprons in 1992 when they performed over 100 scour tests below a model SAF stilling basin (Rice and Kadavy, 1992). See section 2.7.3 for discussion of SAF stilling basins. The riprap size required for stability was strongly dependent on the Froude number (velocity and depth of flow). The depth of scour varied linearly with Froude number and exponentially with the ratio of  $D_{50}/D_1$  where  $D_1$  is the depth of flow before entering the stilling basin. According to Rice and Kadavy, this is not surprising as the energy to be dissipated varies approximately with the square of the Froude number.

The Froude number in the model tests varied from 2 to 12 and the ratio  $D_{50}/D_1$  varied from 0.1 to 1.0.  $D_{50}$  is the riprap size for which 50 percent is smaller by weight and  $D_1$  is the depth of flow. The results showed a fairly extensive riprap apron may be required to avoid significant scour (Rice and Kadavy, 1992).

The riprap apron can be in the form of a plunge pool very similar to the plunge pool dissipator, or it can be a level riprap apron. Although the length of the level riprap apron can be quite a bit shorter than the plunge pool apron, the size of stone may need to be increased to reduce the energy to nonerosive levels. This is shown in the three example designs in the 1992 Rice and Kadavy Report. Figures 16 and 17 in that report show a profile of the transitional riprap apron designs ranging from 45 to 90 feet in length.

### 9.2.3 Hydraulic Properties

If the flow velocity and depth are not known at the downstream end of a concrete energy dissipator, they may be estimated by a water surface profile program (e.g., HEC-RAS developed by USACE). A water surface profile program is a useful tool for estimating these hydraulic parameters at the basin exit and the downstream channel. Although HEC-RAS or other techniques may be used to estimate the general flow characteristics at the basin exit (e.g., average depth, average velocity), there is currently no available means for estimating the erosive potential of eddies, waves, nonuniform flow velocities, and other flow irregularities. More accurate hydraulic estimates can be obtained by model test, if funds are available for such research.

### 9.2.4 Hydraulic design rock chart

USACE's Hydraulic Design Criteria Sheet 712-1 (1970) contains a chart (Hydraulic Design Chart 712-1) of velocity versus stone diameter. The chart is based on the basic equation of rock movement in flowing water developed by Isbash in 1932. The U.S. Army Corps of Engineers Waterway Experimental Station Laboratory did extensive testing with conventional riprap in 1958 and refined the original study done by Isbash. The curves given in Chart 712-1 are applicable to stone densities from 135 to 205 lb/ft<sup>3</sup>. The use of average velocities is recommended for design. The solid lines in the chart represent the minimum and maximum  $D_{50}$  stone weight. The upper limit of stone weight should not exceed the weight that can be obtained from the local quarries. The recommended thickness of the riprap protection should be  $2D_{50max}$  or  $1.5D_{100max}$ , whichever results in the greater thickness. Riprap protection should be extended downstream to where nonerosive channel velocities are established.

### 9.3 Riprap

Riprap refers to a protective blanket of loose stones, which are usually placed by machine. Many factors govern the size of the rock necessary to resist the forces tending to move the riprap. For the riprap itself, this includes the size and weight of the individual rocks, the shape of the stones, the gradation of the particles, the blanket thickness, the type of filter bedding under the riprap, and the slope of the riprap layer. Hydraulic factors affecting riprap include the velocity, current direction, nonangular stones, eddy action, and waves. Experience has shown that riprap failures result from undersized individual rocks in the maximum size range, improper gradation of the rock which reduces the interlocking of individual particles, and improper bedding for the riprap which allows erosion of channel particles through the riprap blanket.

#### 9.3.1 Gradation

Riprap should be a well graded mixture, and is typically specified by either the  $D_{50}$  or the  $W_{50}$ . The gradation should be further constrained to insure that it does not have an excessive quantity of oversize or undersize material. Oversize material can be difficult to place and may not interlock properly with the smaller stones, whereas undersize material has been shown in model studies to be susceptible to displacement. The minimum layer thickness should generally be 1.5 times the maximum stone diameter or 2.0 times the mean stone size ( $D_{50}$ ), but not less than 12 inches.

Reclamation has established riprap gradation based on the weight of stone. Their criteria explained in [Design Standard No. 13, chapter 7, \*Riprap Slope Protection\*, \(2001\)](#) suggests the maximum weight of stone ( $W_{max}$ ) to be equal to four times the median weight ( $W_{50}$ ) and the minimum stone weight ( $W_{min}$ ) to be equal to one-eighth the maximum stone weight. The riprap slope protection in this standard was developed for upstream slopes of earth dams with reservoir wave impacts.

The FHWA's HEC-15, [Design of Roadside Channels with Flexible Linings \(2005\)](#), also provides simple riprap gradation guidelines and recommends riprap be graded such that  $D_{100}/D_{50}$  and  $D_{50}/D_{20}$  both fall within the range of 1.5 to 3.0.

Guidance on riprap gradations for outlet works at low hazard potential dams is shown in Table 707 in the [Boulder County Storm Drainage Criteria Manual \(WRC Engineering, 1984\)](#). The gradations vary from very light (VL), light (L), medium (M), heavy (H), and very heavy (VH) with median stone sizes from 6 to 24 inches. Many federal agencies (i.e., Reclamation, NRCS, and USACE) have similar gradation sizes with class ripraps restricted to only three classes of stone (for example 9-, 16-, and 24-inch median sizes).

The Department of Transportation (DOT) also specifies a number of standard riprap sizes and gradations for each state. Suppliers often maintain an inventory of frequently used classes. Riprap meeting these standardized specifications is often less expensive than special gradations that must be produced on demand.

### 9.3.2 Shape

Rock shapes can vary from elongated, semi-round, and round. The recommended rock shape should be predominantly angular. Flat or plate shaped stones should be avoided since flow readily displaces them. As a general guide, the length of an individual stone should not exceed about 2.5 times its breadth or thickness. Tests have shown that angular rocks are more stable than round rocks. Where rock fails to meet this specification, it may still be considered at the designer's discretion, provided allowance is made in the design for its shortcomings—typically by increasing either size or thickness.

Rock required to meet the necessary size and strength criteria will normally be obtained from a hard rock quarry by drilling and blasting. A hydraulic rock breaker mounted on a hydraulic excavator provides a good method of producing rock to design size specifications. Rock should be a well graded mixture designed to ensure that all interstices between large rocks are filled with rock of progressively smaller size. This has the effect of ensuring that no significant voids occur in the rock blanket through which underlying material can be washed out. Additionally, it helps to create an interlocking mass of rock, which is highly stable.

### 9.3.3 Durability

Individual rock fragments should be hard, durable field or quarry materials free from cracks, seams, and other defects conducive to accelerated weathering. The supplier should certify that the rock was tested and approved for bulk specific gravity, absorption, and soundness criteria in accordance with [ASTM C 127](#).

[ASTM D 4992](#) provides guidance on testing rocks for mineral content, relative density (specific gravity), absorption of water, freeze/thaw resistance, and abrasion resistance. These tests include:

- *Specific gravity.*—Specific gravity is a measure of rock density. Values of greater than 2.60 generally indicate sound quality rock that would be stable in-place, while values less than 2.60 indicate less durable rock with a higher potential for displacement by wave action. Rock with a specific gravity considerably less than 2.60 has been successfully used for riprap, especially when other measures of rock quality are not deficient.
- *Absorption.*—Absorption is a measure of rock porosity. Test results greater than 2 percent may indicate poor quality rock with excessive voids or fracture

systems. Such rock could be susceptible to deterioration from freeze-thaw or wave action.

- *Sodium sulphate soundness.*—Sodium sulphate soundness is an indicator of structural soundness of the rock. Test results showing greater than 10 percent loss may indicate low weathering resistance due to excessive voids and fractures which would be susceptible to freeze-thaw. Typically, there is a good correlation between sodium sulphate soundness and freeze-thaw testing results.
- *Los Angeles abrasion.*—The Los Angeles abrasion test results are an indicator of hardness and structural soundness. The test measures rock resistance to degradation by surface abrasion and impact. Test results greater than 10 percent for 100 revolutions and 40 percent for 500 revolutions indicate a rock likely to abrade from wave action. High quality coarse-grained granitic rock typically sustains high losses from this test, even though it may be of adequate quality for riprap.
- *Deterioration.*—Deterioration is defined as the loss of more than one-quarter of the original rock volume, or severe cracking that would cause a block to split. Measurements of deterioration are taken from linear or surface area particle counts to determine the percentage of deteriorated blocks. Deterioration of more than 25 percent of the pieces should be reason for rejection of rock from the source. The rocks should also be tested for deterioration from freeze-thaw cycles in accordance with [ASTM D 5312](#).

Rock that fails to meet the material requirements discussed in this section may be accepted if similar rock from the same source has been demonstrated to be sound after a specified number of years of service under conditions of weather, wetting and drying, and erosive forces similar to those anticipated for the rock to be installed. A rock source may be rejected if the rock from that source deteriorates within a specified number of years under similar use and exposure conditions expected for the rock to be installed, even though it meets material requirements. Rock exposures of 3 to 5 years are often considered.

### 9.3.4 Placement

Riprap should be placed so that it forms a dense, well graded mass of stone with a minimum of voids. The desired distribution of stones throughout the mass may be obtained by selective loading at the quarry and controlled dumping during final placement. Riprap should be placed to its full thickness in one operation and not by dumping it through chutes or other methods that cause segregation of stone sizes. Care should be taken not to dislodge the underlying base when placing the stones. The finished riprap liner slope should be free of pockets of small stone or clusters of large stones. Hand placing may be necessary to achieve proper distribution of stone



sizes to produce a relatively smooth, uniform surface. The finished grade of the riprap should blend with the surrounding area.

The designer should consider toe placement as many riprap failures are related to changes in the downstream channel from local scour, erosion, etc. and are not riprap failures, but are the toe failures. To reduce the potential for toe failure, be sure the toe is well placed and deep enough.

### 9.3.5 Filter bedding

Filter bedding is a layer of material placed between the riprap and the underlying soil to prevent soil movement into or through the riprap. A suitable filter may consist of a well graded gravel or sand-gravel layer and/or geotextile manufactured for this purpose.

Long term stability of riprap protection is strongly influenced by proper bedding conditions. A large percentage of all riprap failures are directly attributable to bedding failures. Properly designed bedding provides a buffer of intermediate sized material between the channel bed and the riprap to prevent erosion of channel particles through the voids in the riprap. Two types of bedding are in common use—granular bedding filters and geotextiles.

#### 9.3.5.1 Granular bedding

The foundation or subgrade soils that are to be lined with riprap should be free of brush, trees, stumps, and other objectionable material and be graded to a smooth compacted surface. If unsuitable materials are encountered, they should be removed and replaced with soils compatible with the granular backfill.

The design of a granular filter bedding is based on the ratio of particle size in the overlying filter material to that of the base material in accordance with the following criteria. Terzaghi developed the filter criteria in 1922 and it is still used today:  $D_{15F} \leq D_{85B}$  and  $D_{15F} \geq D_{15B}$ .  $D_{15F}$  refers to the filter and  $D_{15B}$  and  $D_{85B}$  refer to the underlying base soil. This criterion prevents soil piping and provides adequate permeability. Filter design guidance can be found in filter design references include NRCS NEH 628, chapter 45, “Filter Diaphragms,” (2007a); Reclamation Design Standard No. 13, chapter 5, *Protective Filters* (2007); and FHWA HEC-15, *Design of Roadside Channels*, 2005. Filter criteria vary between agencies, but Terzaghi’s criteria are still widely accepted.

After an acceptable subgrade for granular bedding material is established, the bedding should immediately be placed and leveled to the subgrade elevation. Immediately following this, the riprap should be placed. In-place bedding materials should not be contaminated with soils, debris or vegetation before the riprap is placed.



### 9.3.5.2 Geotextiles

A geotextile must allow water to pass through it and into the drainage media (granular soil) throughout the design life of the drainage system. The geotextile fabric must also retain the fine soil particles and prevent them from migrating into the drainage system. The selection of a particular geotextile can be accomplished following these basic criteria:

- The geotextile openings must be small enough to prevent migration of soil.
- The geotextile must be permeable enough to allow water to pass through it without a significant reduction in flow.
- The geotextile must have a significant number of pore openings, such that if soil particles block or clog a few openings, the flow through the filter geotextile fabric will still be greater than the required system permeability.
- The geotextile must exhibit adequate strength, chemical resistance, and environmental resistance to prevent it from becoming damaged during installation and throughout the design life of the drainage system.

Geotextile is not a complete substitute for granular bedding. Geotextile provides filtering action only perpendicular to the fabric and has only a single equivalent pore opening between the channel bed and the riprap. Geotextile has a relatively smooth surface which provides less resistance to stone movement. As a result, geotextile may be restricted to slopes no steeper than 2:1.

Geotextiles may be woven or nonwoven and be composed of multifilament yarns or monofilament yarns. Woven slit film (monofilament or multifilament) geotextiles should not be used as a filter beneath riprap, since the materials are weak and the opening size and percent open area is unpredictable. Nonwoven geotextiles should be needle-punched and not heat-bonded or resin-bonded. The permeability of heat-bonded and resin-bonded nonwoven geotextiles is too low to allow adequate seepage and dissipation of hydrostatic pressure. More detailed descriptions of geotextile materials may be found in [AASHTO M288](#), [HCFCFCD \(2001\)](#), [Reclamation \(1992\)](#), and [USACE \(1995a\)](#).

Tears greatly reduce the geotextile's effectiveness, so direct dumping of riprap on the geotextile is not recommended and care must be exercised during construction. Nonetheless, geotextile has proven to be an adequate replacement for granular bedding in many instances. Geotextile provides adequate bedding for channel linings along uniform mild sloping channels where leaching forces are primarily perpendicular to the fabric. Special care of geotextile is required at drop structures and sloped channel drops, where seepage forces may run parallel with the fabric and cause piping along the bottom surface of the fabric. Seepage parallel with the fabric

may be reduced by folding the edge of the fabric vertically downward about 2 feet (similar to a cutoff wall) at 12-foot intervals along the installation, particularly at the entrance and exit of the channel reach. Geotextile should be lapped a minimum of 12-inches at roll edges with upstream fabric being placed on top of downstream fabric at the lap. Fine silt and clay may clog the openings in the geotextile, preventing free drainage and increasing failure potential due to uplift. For this reason, a double granular filter is recommended for fine silt and clay channel beds.

Additional information regarding geotextile is available in [section 9.6 \(\*Articulated Concrete Blocks\*\)](#).

#### 9.4 Grouted riprap

Grouted riprap consists of a stone bed having voids filled with concrete grout to form an aggregate armor to resist erosion from flow. Guidance on grouted riprap can be found in the [USACE's \*Design and Construction of Grouted Riprap\* \(1992\)](#). [Figure 126](#) shows an example of a grouted riprap basin.

Grouted riprap should meet all the requirements for ordinary riprap except that the smallest rock fraction (smaller than the 10 percent size) is usually eliminated from the gradation. Removing stone material smaller than 2 inches will assure a deeper grout penetration. A reduction of riprap size by one size designation or more is often permitted for grouted rock ([WRC Engineering, 1984](#)), but there is no scientific stone reduction formula. As with ordinary riprap, grouted riprap should be placed on a free draining bedding layer.

As a minimum, grout specifications typically include a high slump concrete (5 to 7 inches) in order to penetrate either the full depth of the riprap layer or at least the top 2 feet when the riprap layer is thicker than 2 feet. [USACE's \*Standard Practice for Concrete for Civil Works Structures\* \(1994\)](#) provides guide grout specifications. The grout is usually placed by pumping under pressure through a 2-inch diameter hose to insure complete penetration into the rock layer. Grout usually fills the rock voids to within about 4 inches from the riprap surface.

The advantages of grouted riprap include:

- Potentially economical alternative to conventional riprap, if large stone sizes are not readily available or transportation costs are high.
- Used to repair conventional riprap that has been damaged from water velocities greater than the design values.
- Prevention of vandalism.
- Improved pedestrian access for recreation and inspection.



**Figure 126.**—The grouted riprap has performed well although some of the larger rocks in the foreground are displaced immediately downstream of the concrete apron.

The disadvantages of grouted riprap include:

- Progressive slope failures and failure of the liner, if grouted riprap is placed on a poorly prepared or designed slope.
- Any voids below the surface cannot be detected until the grouted riprap cracks and is displaced.
- Should not be used in areas where frost heave or ice could be expected to cause uplift failures.
- Not recommended if significant soil settlement below the riprap is anticipated.
- If the available riprap is of questionable quality, degradation and poor bonding of the grouted riprap should be expected.

Grouted riprap is rigid and can crack if the soil under the riprap erodes or settles, or due to frost heave of the underlying soil. In addition, grouted riprap will hide soil voids underneath which could crack the grouted riprap during flows. If seepage under the grouted rock is anticipated, weep holes may be provided every 4 to 6 feet at the toe of channel slopes to reduce uplift forces on the grouted channel lining.

### 9.5 Wire-enclosed rock or gabions

Wire-enclosed rock or gabions refer to rocks that are placed together in a wire basket so that they act as a single unit. One of the major advantages of wire-enclosed rock is that it provides an alternative in situations where available rock sizes are too small for ordinary riprap. The gabion baskets can be fashioned into almost any shape that can be formed with concrete. Proper anchorage of the mats is critical to avoid movement in turbulent flow. The durability of wire-enclosed rock is generally limited by the service life of the galvanized binding wire which, under normal conditions, is considered to be about 15 years. Water carrying silt, sand, and/or gravel can reduce the service life of the gabion wire. The wire has been found to be susceptible to corrosion by various chemical agents and is particularly affected by high sulfate soils. If corrosive agents are known to be in the water or soil, a plastic coated wire should be specified. Wire-enclosed rock is not maintenance free and must be periodically inspected to determine whether the wire is sound. If breaks are found while they are still relatively small, they may be patched by weaving new strands of wire into the wire cage. Wire-enclosed rock installations have been found to attract vandalism. Flat mattress surfaces seem to be particularly susceptible to having wires cut and stones removed. Where possible, mattress surfaces should be buried, as it has been found that wire-enclosed rock buried under a few inches of soil is less prone to vandalism. Wire-enclosed rock installations require inspection at least once a year under the best circumstances and may require inspection every three months in vandalism prone areas. Rock filler for the wire baskets should meet the rock property requirements for ordinary riprap. Minimum rock sizes and basket dimensions are shown in the [Boulder County Storm Drainage Design Manual \(WRC Engineering, 1984\) \(Table-708, p. 44\)](#). The maximum stone size should not exceed two-thirds of the basket depth or 12 inches, whichever is smaller.

Wire-enclosed rock requires similar filter bedding (granular or geotextile) as does ordinary riprap. Many wire-basket failures have been attributed to inadequate filtration of the subgrade. The recommendations of the wire-basket supplier should be followed, or alternatively, the recommendations for ordinary riprap filtration may be followed. [Figure 127](#) shows an example of a gabion-lined basin. A basin of this type is best suited only for low hazard potential dams.

### 9.6 Articulated Concrete Blocks

Use of articulated concrete blocks (ACB's) should be limited to low head, low hazard applications. Other applications require a thorough risk analysis that evaluates site-factors, operational frequencies, hydraulic stability, and downstream consequences.

ACBs may be considered for use as an alternative end treatment downstream of conduit outlets ([figure 128](#)) or stilling basins where the hydraulic jump is not occurring. The hydraulic jump should occur on an armored or nonerrodible surface





**Figure 127.**—Gabion-lined basin. The earthen basin was used to facilitate construction access and has been removed.



**Figure 128.**—Modified type PWD basin used with 48-inch diameter conduit with 45 feet of head. The discharge is operationally limited to 150 ft<sup>3</sup>/s.

to prevent undermining of the ACB system. An ACB system consists of a matrix of concrete block units connected by geometric interlock and/or cables, geotextiles, or geogrids. They typically include a geotextile for subsoil retention ([ASTM D 6684](#)). The filter layer may consist of a geotextile, properly graded granular filter, or both. Proper design of the filter layer is critical to the successful performance of the ACB system. The individual blocks of the system are able to conform to changes in

subgrade while connected due to the geometric interlock or other system components such as cables or a geotextile. For additional guidance concerning ACB design, refer to NRCS's *Use of Articulating Concrete Block Revetment Systems for Stream Restoration and Stabilization Projects* (2007b) and Harris County Flood Control District's *Design Manual for Articulating Concrete Block Systems* (2001). As this manual was being prepared for printing, HCFCD (2001) was being revised. Users should consult the most up-to-date edition.

### 9.6.1 Materials

#### 9.6.1.1 Blocks

Several proprietary ACB systems are available. The blocks can be made in a variety of shapes and thicknesses. The thickness of available blocks typically ranges from 4 to 9 inches. Tapered and wedge shaped blocks are also available. [Figure 129](#) illustrates some of the block shapes available.

The blocks are made from precast concrete and are cast into interlocking or noninterlocking shapes. The blocks may be cabled into mats or noncabled. Blocks to be cabled usually have preformed holes cast in them for placement of the cable, although some systems are manufactured with the blocks cast directly onto the cables. The holes should be smooth to prevent damage to the cable.

The blocks may be open-cell or closed cell. Open cell block systems provide an overall system open area ranging from 17 to 23 percent. The open area allows soil to be placed or sediment to fill in the open areas and become vegetated. Closed cell block systems provide a lower percent open area of approximately 10 percent and allow for some soil and vegetation growth. Some individual closed cell blocks can be spaced to provide an open area of greater than 20 percent.

ACBs do not provide strength to a slope; therefore, a protected slope must be geotechnically stable prior to installation of an ACB system.

#### 9.6.1.2 Connections

Individual blocks that are connected into a mat are often referred to as cabled systems. The cable may consist of polyester revetment cable, galvanized or stainless steel, ropes, or, in lieu of cables, an underlying geotextile or geogrid to which the blocks are adhered is sometimes used. The blocks may be assembled into mats off site and trucked to the site or placed individually by hand.

The most widely used connections consist of polyester revetment cable and steel cable. Steel cable is typically stainless steel aircraft cable of type 302, 304, or 316 as shown in [figure 130](#).



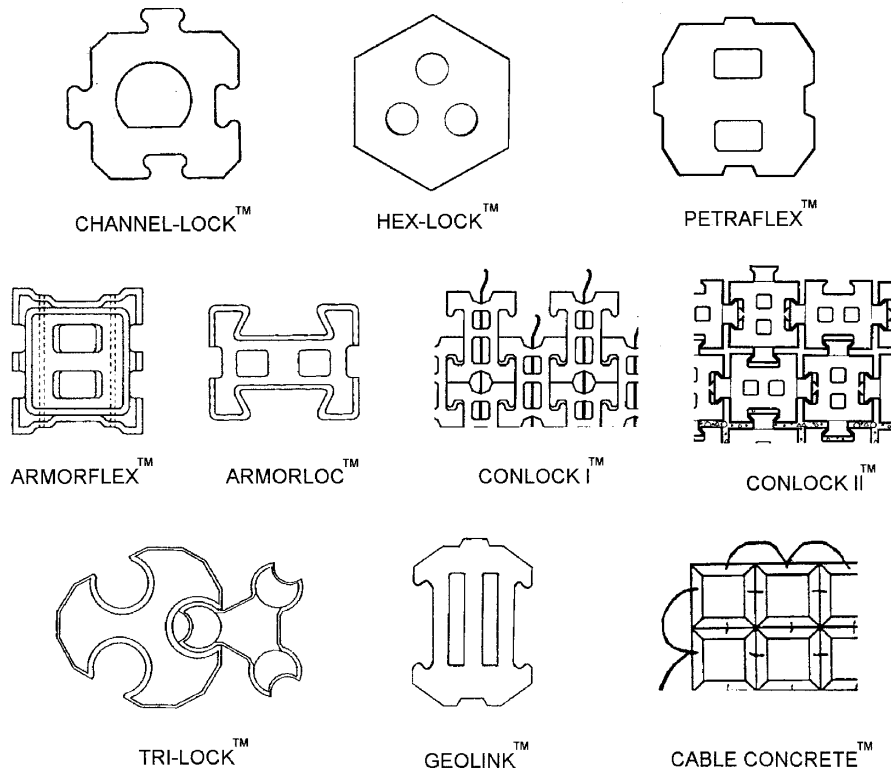

Scale varies between block types

Figure 129.—Examples of ACB revetment systems Courtesy of [HCFCD \(2001\)](#).



Figure 130.—Steel cables.

Polyester cable is typically constructed of high tenacity, low elongating, continuous filament polyester fibers, as shown in [figure 131](#). The cable consists of a core construction comprised of parallel fibers located within an outer jacket or cover. The weight of the parallel core is between 65 and 70 percent of the total weight of the cable. The ends of the cable should be tied.

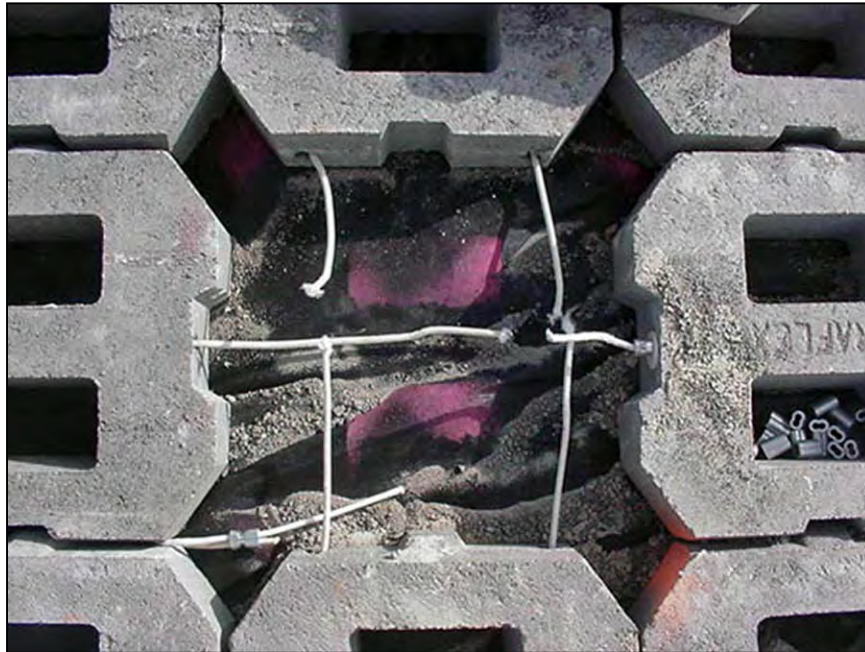

Figure 131.—Polyester cables.

### 9.6.1.3 Geotextile

Refer to [section 9.3.5.2](#) for guidance on use of geotextile.

### 9.6.1.4 Filter

The purpose of the granular filter is to intercept water flowing through the pores of the subgrade soil, allowing passage of the water while retaining the subgrade soil particles. Granular filters consist of sand, gravel, or a sand and gravel mixture and may contain some fine-grained particles.

Fine sand or silt subgrade soils may require the use of a dual granular filter or a combination of a granular filter and a geotextile designed to retain the underlying granular soil. A combination of a granular filter and a geotextile are shown in [figures 132](#) and [133](#).

Granular filter design criteria are presented in [NRCS \(1994\)](#). The NRCS publication provides filter criteria based on the percent finer than the number 200 sieve of the subgrade soil and recommends a minimum permeability for any subgrade soil.

An appropriate filter design is critical to the successful performance of the ACB system. Design of both a geotextile filter and a granular filter includes criteria for filtering and permeability.

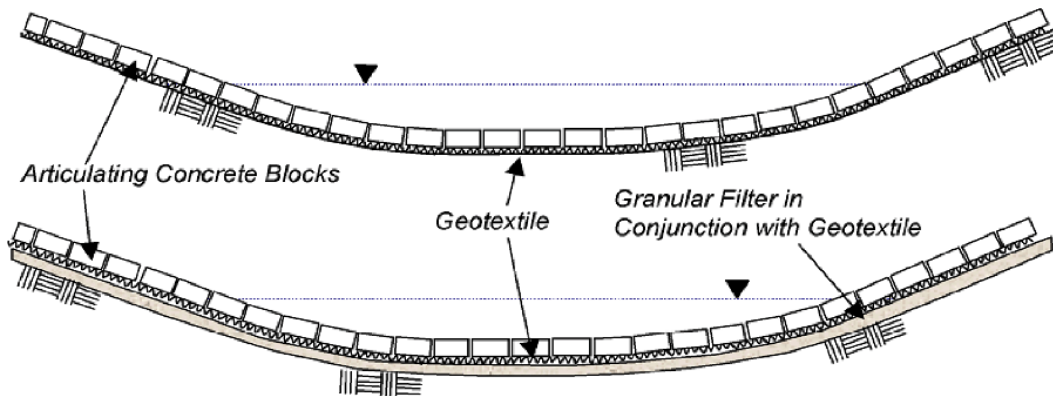

Figure 132.—ACB Section with a geotextile filter and combination geotextile and granular filter. Figure provided courtesy of HCFCD (2001).



Figure 133.—An ACB system using a combination granular and geotextile filter.

Various references are available for design of a geotextile filter. These include [AASHTO M288](#), [HCFCD \(2001\)](#), [SCS \(1991\)](#), and [USACE \(1995a\)](#). Each of these references includes an analysis of the appropriate geotextile “Apparent Opening Size” and permeability. The maximum “Apparent Opening Size” will allow suitable retention of soil particles while the minimum geotextile permeability will allow the free flow of water without a buildup of excessive hydrostatic pressure.

### 9.6.2 Performance testing and evaluation

Due to the proprietary nature and unique characteristics of the ACB systems available, a hydraulic stability test should be completed on each family of blocks. The hydraulic stability test should be conducted in accordance with [ASTM D 7277](#). Research conducted throughout the 1980s ([Clopper and Chen, 1988](#); [Clopper, 1989](#)) led to a definition of “failure” for ACB systems as the local loss of intimate contact between the ACB and the subgrade. The FHWA study ([Clopper, 1989](#)) identified the following four conditions which may lead to this definition of failure:

- Loss of soil beneath the system by gradual erosion beneath the system or washout through the system at joints and open cells.
- Deformation of the subgrade due to liquefaction and shallow slip failures caused by the ingress of water beneath the system (especially in silty soils on steep slopes).
- Loss of block or a group of blocks (noncabled systems) which directly exposes the subgrade to the flow.
- Flow beneath the ACB causing uplift pressure and separation of the block from the subgrade ([figure 134](#)).

Although loss of intimate contact may not lead to total failure of the system, the stability and continued performance of the system has been compromised.

Each ACB system obtains its stability from a unique set of weight, inter-block restraint, geometry, and block to block articulation. Therefore, laboratory testing at Froude scale of each type of ACB system is required for each type of application to determine the “critical” shear stresses and velocities. These shear stresses and velocities must not exceed guidelines.

The [Guadalupe Case history](#) in the appendix illustrates an ACB failure.

### 9.6.3 Design guidance

The design of ACB systems is based on the shear stress and velocity associated with the design flow. The design engineer must determine the factor of safety to be used for a particular project. The determination should consider the risks associated with the failure of the ACB system, complexity of the hydraulic system, uncertainty in hydrologic and hydraulic analyses, and uncertainties associated with ACB system installation. Typically a minimum factor of safety of 1.5 is used for stream revetment project design. A higher factor of safety of 2.0 is often recommended for complex hydraulic systems because of the lack of performance history with ACB design, in conjunction with energy dissipating structures. Significant failures are shown in





**Figure 134.**—Insufficient anchorage resulted in uplift of these ACB blocks during flow.

figure 134 and discussed in the appendix (Guadalupe case history). The designer should proceed with caution when using ACB protection for critical dam structures.

Failure (loss of intimate contact) is typically the result of overturning of a block or group of blocks about the downstream contact point of the block. The hydraulic stability of a block on a channel side slope is a function of the magnitude and direction of stream velocity and shear stress, the depth of flow, channel side slope, channel bed slope, inter-block restraint, block geometric properties, and the weight of the block.

Additional design guidance is available in [NRCS \(2007b\)](#).

### 9.6.4 Specifying ACB systems

#### 9.6.4.1 Materials

The blocks, connections, and geotextile need to be specified:

- *Blocks.*—The blocks should meet the physical requirements of [ASTM D 6684](#) Standard Specification for Materials and Manufacture of Articulating Concrete Block Revetment Systems.

In areas subject to freeze-thaw, the number of freeze thaw cycles and the corresponding weight loss criterion should be specified. Some specifications

require 100 freeze/thaw cycles with no more than 1 percent weight loss as determined on 5 block samples. The minimum percent open area should also be specified.

- *Connections.*—If a cabled system is desired, the cable specifications recommended in the ASTM Standard should be considered. If the blocks will be adhered to a geotextile, the geotextile should meet the geotextile specifications discussed in the next paragraph.
- *Geotextile.*—Several agencies have developed specifications for geotextiles. The NRCS has developed national construction and material specifications for geotextiles. These are included in the [National Engineering Handbook \(NEH\), Part 642 \(2001\)](#). The NRCS specifications are broken into woven and nonwoven geotextiles and into various classes. Class I geotextiles are typically specified for erosion protection systems. Reclamation also provides geotextile guidelines and specifications ([Design Standards No. 13, Embankment Dams, Chapter 19, “Geotextiles”](#)). Additionally, the “Annual Specifier’s Guide” by *Geosynthetics Magazine* provides a useful compilation of the engineering properties of a wide variety of geotextiles from numerous manufacturers.

#### 9.6.4.2 Testing

A hydraulic stability test conducted in accordance with [Clopper \(1988\)](#) on the proposed ACB system should be specified. The stream bed slope of the project should be no steeper than the slope used in the hydraulic stability test. If the ACB system was tested with system restraints (such as mechanical anchors) or ancillary components (such as a synthetic or granular drainage medium) these features should also be incorporated into the field installations.

#### 9.6.4.3 Design

A particular ACB system or the project specific design criteria should be specified to allow each ACB system manufacturer to calculate which product should be supplied. The following project conditions should be specified:

- Design velocity (ft/s).
- Design shear stress (lb/ft<sup>2</sup>).
- Bed slope (ft/ft).
- Side slope (H:V) (ft/ft).



- Maximum allowable block-to-block placement tolerance (vertical and horizontal) (inches).
- Minimum required factor of safety.
- Method of computing the factor of safety.

### 9.6.5 Installation

Detailed specifications are required for the installation of ACB systems. Detailed construction specifications for earthwork (including subgrade preparation) and placement of the geotextile are available from the NRCS, USACE, HCFCD, and other organizations. ACB installation specifications are available from the USACE, HCFCD, ACB manufacturers, and other organizations. An ASTM Standard Practice for the Installation of ACB Revetment Systems ([ASTM D 6884](#)) provides guidance on installation of ACBs. General installation considerations are discussed in the following sections.

#### 9.6.5.1 Subgrade preparation

The ACB system should be placed on undisturbed in-situ soils or properly compacted fill. The subgrade for ACB placement should be graded smooth to ensure intimate contact is achieved between the surface and the geotextile.

#### 9.6.5.2 Geotextile placement

The geotextile should be laid flat and smooth so that it is in intimate contact with the subgrade. The geotextile shall be free of tension, folds, and wrinkles. The geotextile should be placed immediately prior to ACB placement.

The joints should be overlapped a minimum of 18 inches in dry installations and 3 feet in below-water installations. The geotextile joints should be shingled so that the upstream or up-slope geotextile overlaps the adjacent downstream or down-slope geotextile.

When a granular filter is used in combination with a geotextile filter or the geotextile is placed on a silty sand or fine to medium sand subgrade, the geotextile should encapsulate the granular filter for a minimum length of 1 foot of the subgrade as shown in [figure 135](#).

#### 9.6.5.3 Placement of the ACB

The cellular concrete blocks should be placed on the geotextile or subgrade in such a manner as to produce a smooth plane surface in intimate contact with the geotextile

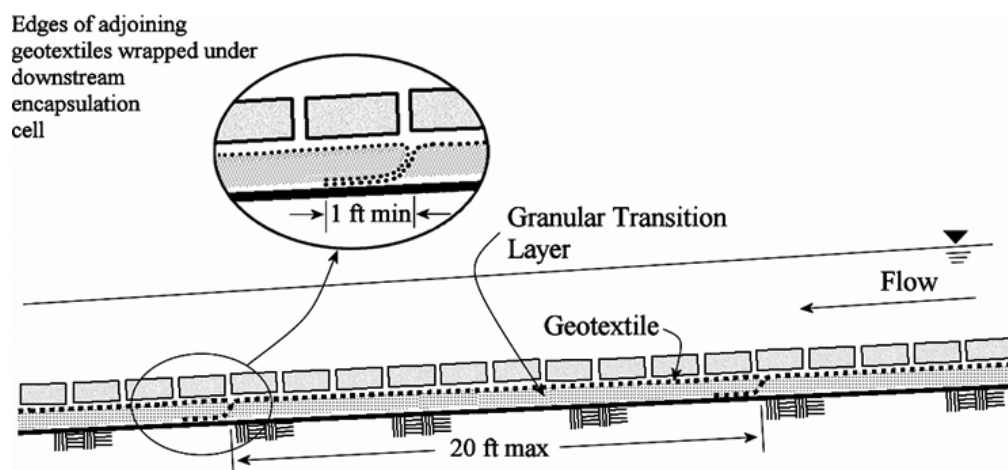

Figure 135.—Granular filter encapsulation by a geotextile. Figure provided courtesy of HCFC (2001).

or subgrade. No individual block within the plane of placed cellular concrete blocks shall protrude more than the maximum protrusion used in the design and specified for the project. If assembled and placed as large mattresses, the cellular concrete mats shall be attached to a spreader bar or other approved device to aid in the lifting and placing of the mats in their proper position by the use of a crane or other approved equipment. The equipment used should have adequate capacity to place the mats without bumping, dragging, tearing or otherwise damaging the underlying fabric. The mats shall be placed side by side and/or end to end, so that the mats abut each other. Mat seams or openings between mats greater than the typical separation distance between blocks should be filled with grout. Whether placed by hand or in large mattresses, distinct changes in grade that results in a discontinuous revetment surface in the direction of flow should include a grout seam at the grade change location so as to produce a continuous surface.

Termination (or top of slope) trenches, and side trenches should be backfilled and compacted flush with the top of the blocks. The transition from the slope into the trench should be rounded. The integrity of a soil trench backfill must be maintained so as to ensure a surface that is flush with the top surface of the cellular concrete blocks for its entire service life. Toe trenches should be carefully backfilled to minimize any potential for undermining. Backfilling and compaction of trenches shall be completed in a timely fashion. No more than 500 lineal feet of placed cellular concrete blocks with incomplete termination and/or toe trenches should be permitted at any time.

### **9.6.5.4 Termination**

The ends of the ACB system should be buried in termination trenches, which are backfilled with compacted material flush with the top of the blocks. The trench may also be backfilled with properly sized riprap, concrete, or other armoring material.

### **9.6.5.5 Anchor**

Anchors provide a secondary line of defense against uplift. The anchor penetrations through the geotextile should be filled with grout to reduce migration of the subgrade soil through the penetration point.

### **9.6.5.6 Filling**

The open area of the ACB should be filled with topsoil (to support vegetative growth) or gravel material. The fill within the open area should be completed as soon as possible. Topsoil should be overfilled by 1 to 2 inches to allow consolidation of the fill material. A vegetated condition will improve the overall stability of the system by the root penetration and anchorage; however, the additional stability benefit provided by vegetation is ignored for sake of conservatism in the design. Preferred vegetation through the blocks is native grasses. Woody shrubs and trees are discouraged due to the potential for roots heaving the blocks.

## Chapter 10

# Baffled Drops

Baffled drops (also called baffled aprons, baffled chutes, and Reclamation basin type IX) consist of a variety of different types, shapes, and configurations of vertical or horizontal panels or walls that serve to dissipate flow energy by redirecting it against itself or another surface. Although baffled drops are not generally used as a primary outlet works energy dissipation device, they may provide reliable and cost effective means of incorporating changes in grade elevation into outlet channels in applications where a typical hydraulic jump stilling basin is undesirable. A critical consideration in the design of a baffled drop is the Froude number of the entering flow. The choice of baffling system and structure configuration differs significantly depending on the flow regime entering the baffled drop:

- Subcritical flow structures are generally used to dissipate the energy at a change in grade.
- Supercritical flow structures are generally used to directly dissipate the energy of the high velocity flow by impact, after which a subcritical hydraulic grade control structure is used.

Several sources are available for baffled drops, but the primary source used in this chapter is the [Bureau of Reclamation's \*Hydraulic Design of Stilling Basins and Energy Dissipators\* \(1984\)](#). The following sections were summarized from that document and other sources as noted.

### 10.1 Design Considerations

An example of a baffled drop is shown in [figure 136](#). Incoming flow is directed onto a row of spaced baffles. The flow is split again by a downstream second row of offset baffles. The flow encounters additional rows of baffles until the bottom of the drop is reached. The flow basically “tumbles” down the drop from baffle to baffle dissipating energy along the length of the chute. Because this “tumbling” dissipates the energy, exit velocities from the drop are low regardless of the tailwater elevation. Since a baffled drop does not require a specific tailwater elevation, it can be a viable potential energy dissipation option where tailwater elevation varies.



Figure 136.—Typical baffled drop at a change in grade.

A benefit of the baffled drop is the fact that often only five or six rows of baffles are necessary to achieve air-saturated flow. If the incoming flow is supersaturated with air, only a few rows of baffles will deaerate the flow resulting in saturated water flow. On the other hand, if the incoming flow is deficient in air, only a few rows of blocks will aerate the flow so that it becomes saturated.

Advantages of the baffled drop include:

- The design is independent of tailwater elevation or rating curve. Allowances for predicted future degradation can be incorporated into the design.
- Straightforward and easy to use design guidance.
- A long history of good performance when design guidance is met.
- Aerates the water.
- Their performance has shown that trash collects on the falling stage of a flow event and is removed on the rising stage of the next flow event.

Disadvantages of the baffled drop include:

- Limited to 60 to 80 ft<sup>3</sup>/s per foot of width unless model tested. This can lead to very wide structure design for high discharges.

- Approach flow needs to be subcritical. However, another energy dissipation structure can be added upstream to accomplish this if needed.
- Typically needs at least four rows of baffles to adequately control the flow.
- Water can splash over the sidewalls requiring erosion protection along the length of the structure.
- Typically built on a 2:1 horizontal to vertical slope.

Flow approaching the chute should be well distributed laterally and below critical velocity. Preferred approach velocity values are shown in [figure 137](#) and indicate approach velocities should be less than 8 feet per second for unit discharges up to 70 ft<sup>3</sup>/s per foot of width. An upstream depression basin can reduce higher velocities. A depression basin is basically a sudden expansion that is lower than the approach channel or baffled drop invert and slows the water down. If the inflow is supercritical, this “depressed” basin acts as a stilling basin to lower the water below critical depth and velocity. The [Urban Drainage and Flood Control District’s Drainage Criteria Manual \(2008\)](#) has an approach depression design to help lower approach velocities when they are too high ([figure 138](#)).

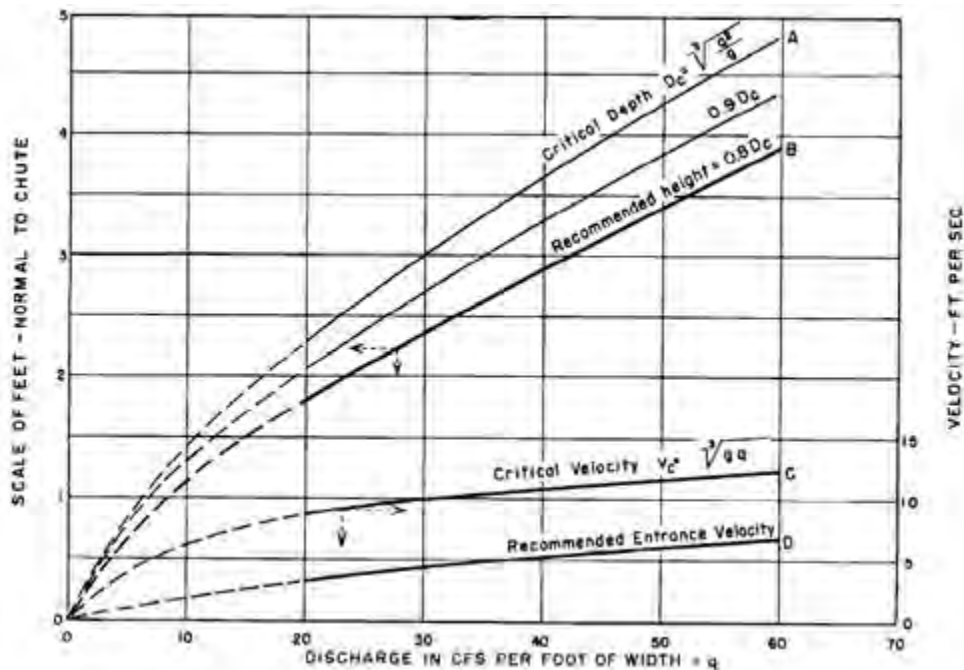

Figure 137.—Flow depth and acceptable approach velocities (Reclamation, 1984, p. 174). See Reclamation (1984) for information related to the variables as denoted in this figure.



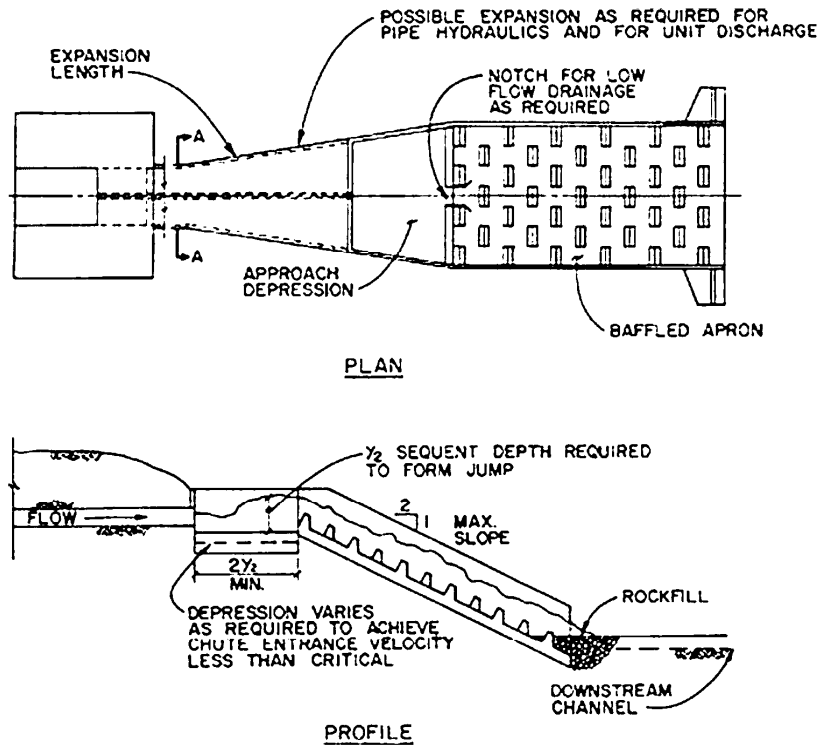

Figure 138.—Baffled chute with approach depression to lower approach velocities (Urban Drainage and Flood Control District, 2008, p. HS-76). See Urban Drainage and Flood Control District (2008) for information concerning the variables as denoted in this figure.

As flow enters the baffled drop at near or above critical velocity, the flow collides with the first row of baffles and is thrown vertically in the air causing excessive spray in the approach area that increases the potential for erosion (Reclamation, 1984, p. 174). With high approach velocities, flow could pass completely over the first and second rows of baffles, diminishing the energy dissipation. With approximately seven rows of baffles, the water becomes saturated. Rock riprap is recommended along the outside walls of the chute to control erosion due to spray from the highly aerated water. Figure 139 shows some erosion of the backfill due to this type of spray. Figure 140 shows another example of spray conditions. In this figure, the riprap along the side of the channel in is wet although the mean flow depth in the chute is well below the channel walls.

Baffled chute slopes are typically designed at a slope of 2:1 or flatter with the chute extending below the outlet channel invert. Slopes steeper than 2:1 should be model tested before being constructed. The depth of construction below the outlet channel floor is typically based on estimated scour or degradation in the outlet channel. The chute needs to be installed deeply enough to prevent damage from the estimated degradation and scour (Reclamation, 1984, p. 185). The long term potential for



**Figure 139.**—This baffled drop has a chute that is 9 feet wide and 90 feet in length founded upon a 2:1 slope. The training walls are 5 feet high. The baffles are 18 inches high and wide with 18-inch spaces between them. The rows of baffles are all 6 feet apart ([Reclamation, 1984, p. 187](#)).

scour and degradation along the outlet channel should be considered in the design of the baffled drop.

Another consideration is the unit discharge for the chute design. Unit discharge is defined as the discharge per foot of the chute width and is estimated by dividing the total discharge by the chute width. The typical design for a baffled chute limits the unit discharge to 10 to 80  $\text{ft}^3/\text{s}$  per foot of width. Reclamation has designed baffled drops for this range that have operated effectively up to 150  $\text{ft}^3/\text{s}$  per foot of width. The USACE has model tests with a specially designed baffle for unit discharges of up to 180  $\text{ft}^3/\text{s}$  per foot of width that have adequate energy dissipation for flows up to 900  $\text{ft}^3/\text{s}$  per foot of width ([USACE, 1990, p. 7-15](#)). Physical model studies are recommended when either the original design unit discharge of 80  $\text{ft}^3/\text{s}$  or a slope of 1:2 or steeper is exceeded.

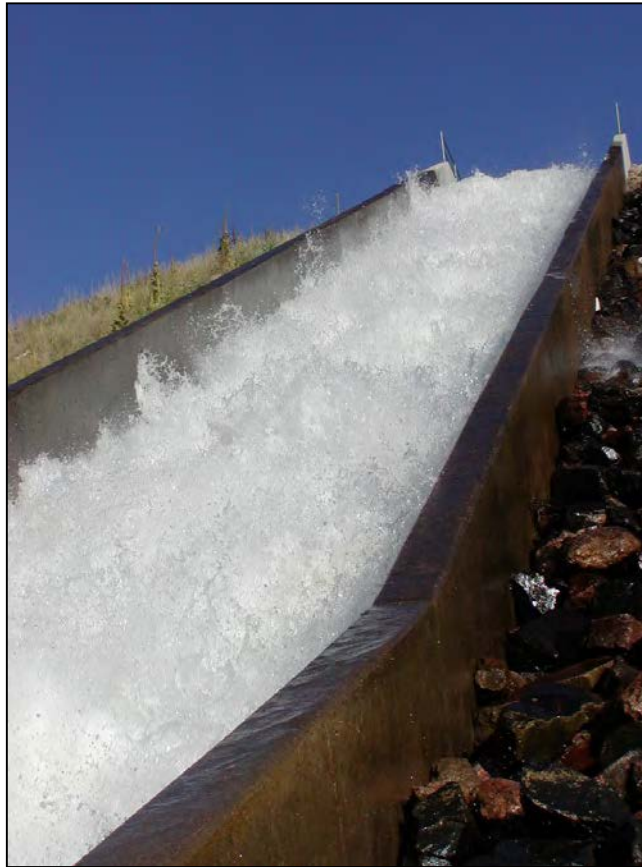

Figure 140.—Baffled drop aerating the flow so that it becomes saturated.

### 10.2 Design Guidance

Design guidance is available from several sources, such as [Reclamation's \*Hydraulic Design of Stilling Basins and Energy Dissipators\* \(1984\)](#), and will be summarized in this section. The starting point is to determine the maximum expected discharge for the baffled drop ( $Q$ ). The unit design discharge is calculated using equation 43:

$$q = Q/W \quad \text{eq. 43}$$

where,

- $q$  = unit discharge ( $\text{ft}^3/\text{s}$  per foot of width)
- $Q$  = total discharge ( $\text{ft}^3/\text{s}$ )
- $W$  = chute width (ft)

The chute width may also depend on the upstream or downstream channel width. Model studies have also indicated that a chute with a large unit discharge can be

based on about two-thirds of the maximum expected discharge and still obtain good energy dissipation. However, the chute walls need to be high enough to confine the maximum expected discharge.

The entrance velocity should be as low as possible. Either [figure 137](#) or the following equation (Curve *D* on [figure 137](#)) can be used for flows up to 69 ft<sup>3</sup>/s per foot of width.

$$V_1 = \sqrt[3]{gq} - 5 \quad \text{eq. 44}$$

where,

$$\begin{aligned} V_1 &= \text{approach velocity (ft/s)} \\ g &= \text{acceleration of gravity (32.2 ft/s}^2\text{)} \\ q &= \text{unit discharge (ft}^3\text{/s per foot of width)} \end{aligned}$$

As velocities near or exceed the critical velocity (see eq. 45), flow strikes the first row of baffle piers and is thrown in the air. Proper conditions for flow entering the baffled drop are critical to satisfactory energy dissipation and structure performance.

$$V_c = \sqrt[3]{gq} \quad \text{eq. 45}$$

where,

$$\begin{aligned} V_c &= \text{critical velocity (ft/s)} \\ g &= \text{acceleration of gravity (32.2 ft/s}^2\text{)} \\ q &= \text{unit discharge (ft}^3\text{/s per foot of width)} \end{aligned}$$

Next, the vertical offset between the approach channel floor and chute floor is used to establish a uniform approach velocity ( $V_1$ ). While the offset varies with installation, many times, a short-radius curve is provided. An alternative entrance configuration, the Fujimoto entrance, can be used as shown in [figure 141](#). This entrance has been successfully used on structures where the design unit discharge exceeds 100 ft<sup>3</sup>/s per foot of width. A physical model study should be performed to determine the optimum location for the first row of baffle piers.

The first row of baffle piers should be placed no more than 12 inches below the crest elevation. The baffle piers should be staggered by row to provide a baffle pier below each space between the baffle piers in the next upstream row. Backwater should be estimated to determine if the baffle piers affect upstream water surface profiles.

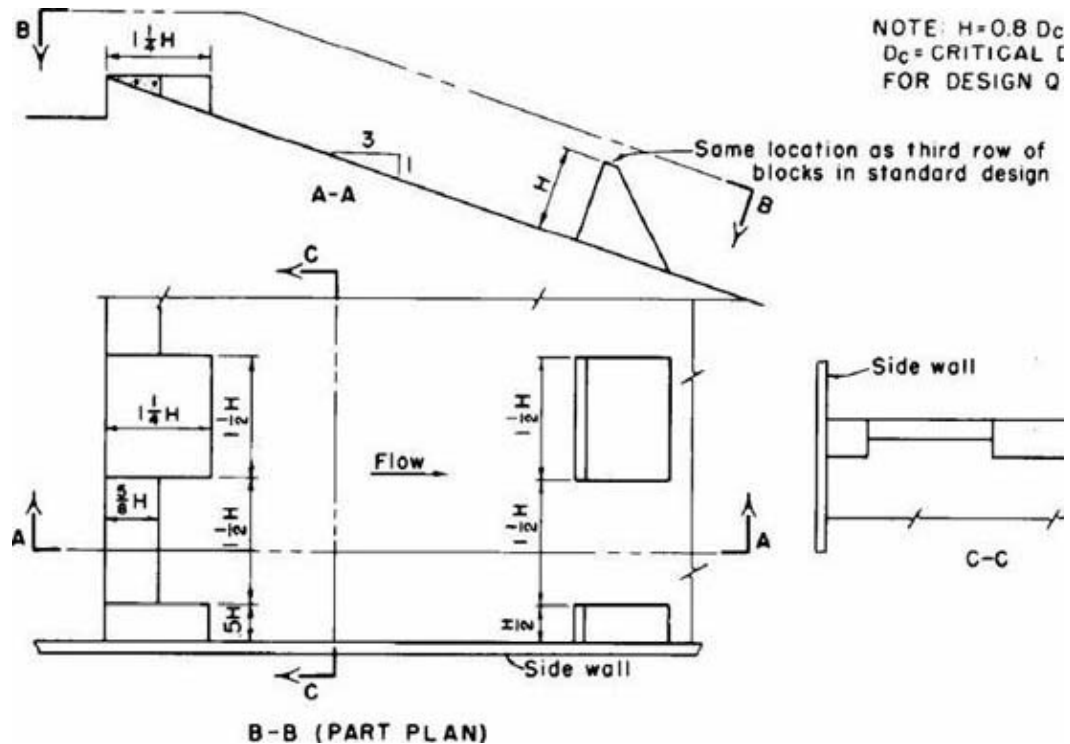

Figure 141.—Fujimoto entrance for baffled drops (Reclamation, 1987, p. 361). See Reclamation (1987) for information related to the variables as denoted in this figure.

Baffle pier height ( $H$ ) should be about  $0.8D_c$  or  $0.9D_c$ , where  $D_c$  is the critical depth for the rectangular chute as computed by Curve A in figure 137 or by:

$$D_c = \sqrt[3]{q^2 / g} \quad \text{eq. 46}$$

where,

- $D_c$  = critical depth of flow (ft)
- $q$  = unit discharge ( $\text{ft}^3/\text{s}$  per foot of width)
- $g$  = acceleration of gravity ( $32.2 \text{ ft}/\text{s}^2$ )

Baffle pier height should not be less than recommended. For unit discharge values greater than  $60 \text{ ft}^3/\text{s}$  per foot of width, Curve A on figure 137 may be extrapolated.

Baffle pier width and spacing should be equal using  $1.5H$  but not less than  $H$ . Other dimensions are not critical, but suggested dimensions are shown in figure 142.

The spacing down the slope between the rows of baffle piers should be  $H$  divided by the slope, where the slope is given in decimal form. For example, a 2:1 slope (0.50 in decimal form) makes the row spacing  $H/0.5$  or  $2H$  parallel to the chute floor.

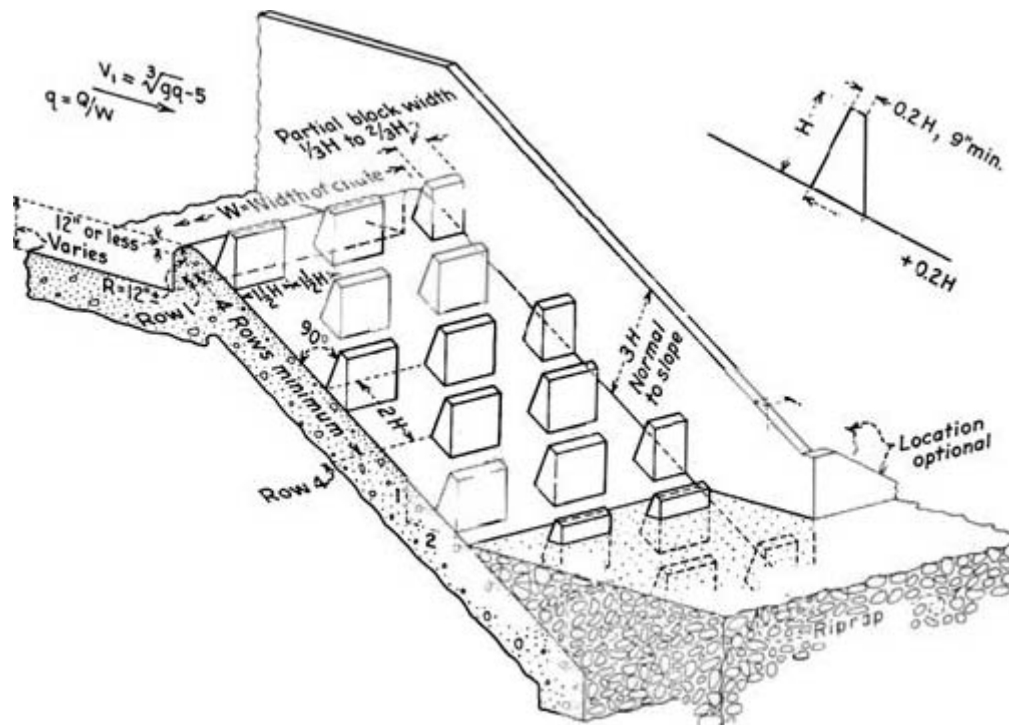

Figure 142.—Typical baffled drop layout (Reclamation, 1987, p. 361). See Reclamation (1987) for information related to the variables as denoted in this figure.

Baffle piers are typically constructed with the upstream face normal to the chute floor, but piers with vertical faces may be used. Baffle piers with vertical faces tend to produce more splash and less bed scour, but overall the differences are minor.

Four rows of baffle piers are typically needed to establish full control of the flow (some chutes with fewer rows of baffle piers have operated successfully). At least one row of baffle piers should be buried below the outlet channel grade to protect against scour. Additional rows of baffle piers may be buried as needed to protect against degradation.

Chute walls should be three times as high as the baffle piers measured normal to the floor. This height contains the main flow and most of the splash. The walls do not need to be built high enough to contain the entire splash from the baffle piers. If the chute has been designed for less than the maximum flow, the wall height may need to be increased accordingly.

Riprap should be sized and placed at the downstream end of the training walls to prevent erosion of the banks near the chute exit.



For all of these designs, debris accumulation and subsequent maintenance should be considered in the design. This becomes more important for those structures using a depression basin upstream to lower entrance velocities into the baffled drop; the depression basin may become a debris basin. Including a low flow drainage channel in the chute to drain the upstream depression basin should be considered.

### 10.3 Baffled Drops for Conduit Outlets

Baffled drops are typically used in irrigation canals, conveyance structures, and spillways, but the design can be used for outlet conduit energy dissipation. A transition is needed from the rectangular or circular conduit to the rectangular width of the baffled drop. Close attention to the conduit outlet velocity is needed to meet approach velocity guidance. The designs shown in figures 138 and 143 may be considered.

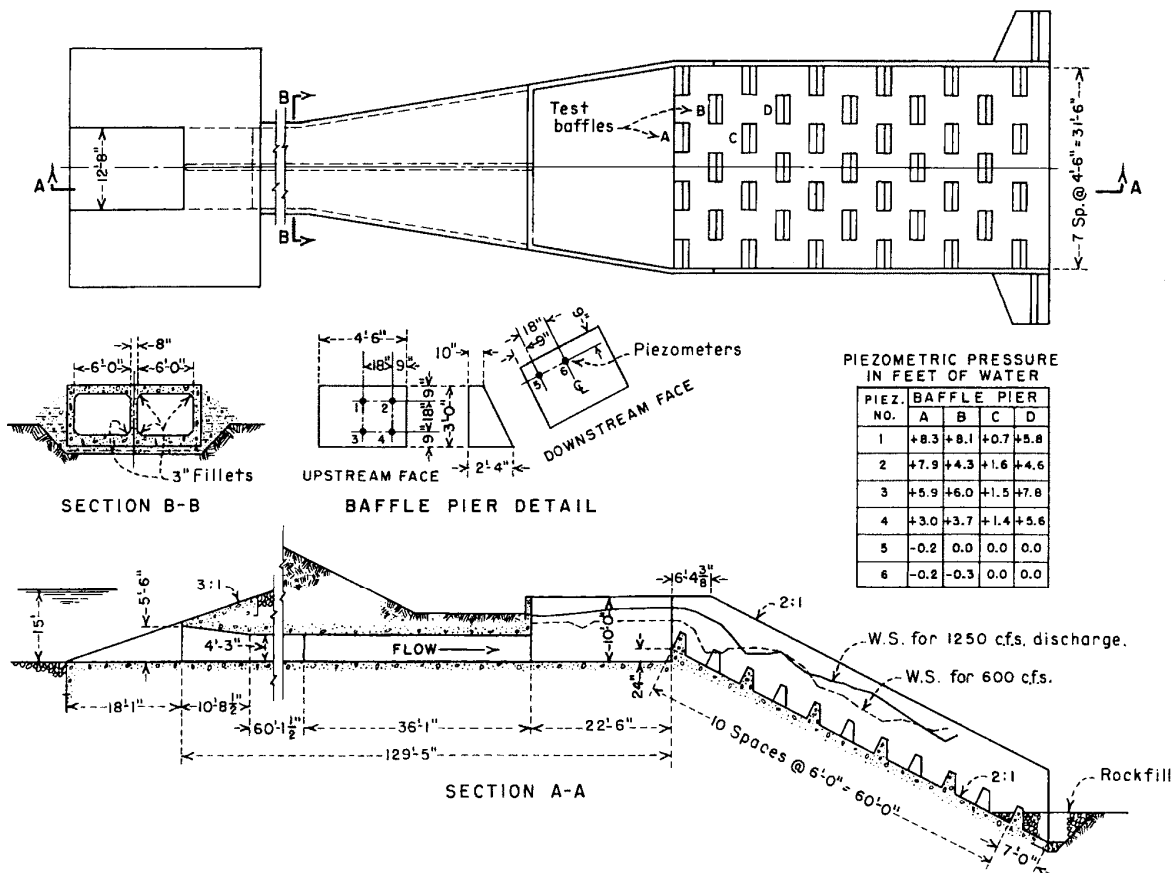

Figure 143.—Typical plan for baffled drop downstream from box culverts (Reclamation, 1984, p. 154).

## Chapter 11

# Inspection

Inspection of energy dissipation structures can detect many developing problems before safety and reliability are affected. Inspection should also assess the adequacy and quality of maintenance procedures. Periodic inspection may reveal trends that indicate that more serious problems are developing. The dissipation structure is typically inspected as part of an overall inspection of the dam and its appurtenant features. However, depending on the type of dissipation structure, many of its components are often submerged, and a complete examination cannot always be routinely made. Factors such as the frequency of operation at full discharge or larger than normal discharge capacity, seismic activity, or other special conditions may require additional inspection.

Inaccessible features should be inspected regularly unless compelling justification exists to increase the frequency of inspection or to discontinue inspections.

Typically, structural defects and deterioration develop progressively over time. A trained and experienced inspector can identify defects and potential problems before existing conditions become serious. However, some situations (e.g., seismic events) can arise suddenly and cause serious damage in a short period of time.

As discussed in [FEMA's \*Conduits through Embankment Dams\* \(2005\)](#), 14 federal and state agencies developed a comprehensive training program (Training Aids for Dam Safety [TADS]) designed to train individuals involved with, or having responsibility for the safety of dams. The TADS program consists of modules that can be tailored to meet individual or organizational needs. The TADS program is widely used and recognized by the dam safety community. Further details on the TADS program are available from Reclamation. Also, training courses on dam safety inspection are available from various sources. Interested parties should consult the Association of State Dam Safety Officials (ASDSO) website for a listing of available training opportunities.

General information concerning types of inspection, preparing for an inspection, and performing an inspection can be found in [FEMA's \*Conduits through Embankment Dams\*](#) and the TADS modules. This chapter will focus solely on the inspection concerns involving energy dissipators. Portions of this chapter have been adapted from [chapter 9 in FEMA's \*Conduits through Embankment Dams\* \(2005\)](#).

All new structures should be designed with adequate provisions to accommodate inspection (i.e., slots for bulkheads and stoplogs, properly sized underdrains for closed circuit television, and provisions to control hydrostatic uplift when structures are unwatered for inspection).

### 11.1 Types of Inspections

Inspection intervals may vary, depending on the overall conditions determined from previous inspections and the existence of any dam safety concerns. Periodic inspections can vary in scope and purpose and by the organization or personnel (damtender, agency/district level, etc.) performing the inspection.

Dam safety organizations and dam owners may employ a variety of inspections during the life of a dam and its appurtenant features including its energy dissipation structure (figure 144). These inspections may include the following types:

- *Initial or formal.*—Initial or formal inspections include an in-depth review of all pertinent data available for the structure to be inspected. Design and construction data are evaluated relative to the current state-of-the-art to identify potential dam safety problems or areas requiring particular attention. A thorough onsite inspection of all features is conducted, and an attempt is made to operate all mechanical equipment through their full operating ranges if possible. Many federal and state agencies require formal inspections on a set frequency. Formal inspections are often performed shortly after both the initial construction and major modifications for a dam as well as when an existing dam is new to a dam safety program.
- *Periodic or intermediate.*—Periodic or intermediate inspections are conducted between formal inspections. An in depth review is made of all pertinent data available on the structure to be inspected. However, the data review focuses on the current status of the structure, and the data are not evaluated relative to current state-of-the-art criteria. A thorough onsite inspection of all features is conducted. All mechanical equipment may not be tested during any one inspection. Some equipment may be operated at another time or during the next inspection.
- *Routine.*—Field or operating personnel typically conduct routine inspections. The primary focus is on the current condition of the structure. Available data might not be reviewed and evaluated prior to the inspection, depending on the inspector's familiarity with the dissipation structure. Inspections may be scheduled regularly or performed in conjunction with other routine tasks.



Figure 144.—A periodic inspection being performed at an impact basin.

- *Special*.—A special inspection is conducted when a unique opportunity exists for inspection. For example, if a reservoir is low, exposing a normally inundated structure, a special inspection may be arranged. A special inspection may also be performed to examine conditions related to a specific deficiency.
- *Emergency*.—An emergency inspection is performed when an immediate dam safety concern is present or in the event of an unusual or potentially adverse condition (e.g., immediately following an earthquake).

The actual terms and meanings used to define the types of inspection may vary between dam safety organizations and dam owners.

The operating personnel responsible for daily operation and maintenance of the facility should also participate as inspection team members. Where applicable, water user organization representatives should also participate in the inspection. Additionally, the applicable state water resource agency may need to be advised for their possible participation in the inspection.

To the extent possible, inspections should be scheduled in different seasons. This will enable the structure or facility to be examined for differing reservoir levels, water deliveries, and site conditions. Also, to obtain a variety of perspectives, avoid use of the same inspector each time an examination is performed.

Before beginning inspection of a facility, the inspection team should discuss the order in which features are to be examined to accommodate operations as well as to ensure that time for the inspection team is appropriately allotted. In addition, the team should conduct a job hazard analysis (JHA) prior to the inspection, whereby procedures and equipment necessary to minimize or avoid potential safety and health hazards are discussed. Of primary importance is the need for detailed clearance (particularly if there are confined spaces), and lockout or “tag-out” procedures when accessing areas affected by equipment or valve/gate operations.

### 11.2 Factors Influencing Scheduling of Inspections

Scheduling of periodic inspection may be influenced by (Reclamation, 1988, p. III-7):

- *Sufficient notice.*—Dam owners and operators may need sufficient time to make arrangements, such as preinspections, associated with lockout/tagout and confined space entry, special equipment, or special approval for unwatering. This process could require several weeks or months, depending on the facility.
- *Scheduling access.*—Access for the inspection should be scheduled when most or all of the major components of the structure can be examined. Some features, such as blocks, end sills, and floor slabs are usually submerged and not accessible. Structures may or may not be able to be unwatered and made accessible for inspection. The dam owner or operator may be requested to provide notification when reservoir conditions permit or when the reservoir can be drawn down to allow the inspection to be performed.

If the feature to be inspected is normally inundated and inaccessible, certain factors (Reclamation, 1985, p. 4) should be considered in determining the extent and frequency for inspection, such as:

1. Results of a previous “hands on” inspection or evidence from the inspection of the normally accessible portions of the feature. Inspection of the normally accessible portions of a feature may provide information on the probable condition of the inaccessible portion. This information may include:
  - a. *Condition of the feature.*—Cracking, joint separation, or significant deterioration.
  - b. *Flow conditions.*—Changes in the discharge capacity of the outlet works (caused, for example, by sediment or debris buildup).

- c. *Damage and deterioration.*—Damage or deterioration of valves, gates, and metalwork.
      - d. *Water quality.*—Water quality known to be detrimental to concrete or waterstops. Excessive amounts of sand or other material transported by the discharge could cause poor water quality.
2. Operational history and performance of the dissipation structure since its previous inspection.
3. Relative costs for providing access for inspection of the dissipation structure, including costs associated with lost water and power revenues.
4. Age of the feature.
5. Design and construction considerations such as:
  - a. *Changes in standards or guidelines.*—Design criteria, construction techniques, and/or quality of material at the time of construction that fail to meet current standards or guidelines.
  - b. *Foundation conditions.*—The dissipation structure was constructed on foundation of varying compressibility, where there is a potential for differential settlement. This may result in cracking of the structure or excessive opening of joints. Differential settlement is also possible between the chute and stilling basin due to different pressures being exerted on them.
  - c. *Foundation faults.*—The dissipation structure crosses a foundation fault where there is the potential for movement or disruption of the structure.
6. Critical function of the dissipation structure.
7. Frequency of use of the energy dissipator.
8. Any existing site conditions that may compromise the safety of the feature (e.g., rockfall onto the structure).
9. The appropriate frequency and extent to which the normally inundated features are examined will vary based on available information. The review personnel and decision makers will need to determine the appropriate frequency and extent based on the above factors. As an example, Reclamation has identified about 6 years as an appropriate



frequency for a “hands-on or equivalent inspection frequency” for inaccessible features like dissipation structures.

- *Operation.*—Certain problems may not normally appear when the feature is dry that appear when the feature is being operated. Also, when a feature is operating during a period of higher than normal releases, additional information may be gathered that may not have been available during normal operations.

The opportunity to optimize both access and operation during a single inspection typically is not possible. Inspection objectives may have to alternate from one inspection to the next. This may necessitate the need for scheduling “special” inspections during unusual conditions, in addition to regular inspections, to provide a comprehensive understanding of the dissipation structure’s safety. Special inspections may be required after floods, seismic activity, or other unusual or extreme events.

### 11.3 Periodic Inspections by Selected Organizations

The frequency of periodic inspections varies among federal, state, local organizations and agencies, and dam owners. Emergency situations may require much more frequent inspections, such as daily or hourly. Situations can arise suddenly that cause serious damage in a short period of time. Examples of these problems are operations at full discharge capacity and seismic activity. The need for special inspections should be evaluated after occurrence of any of these situations. [FEMA’s \*Conduits through Embankment Dams\* \(2005\)](#) has a sampling of periodic inspections that selected organizations require.

### 11.4 Preparing for an Inspection

The success of an inspection depends upon good planning and preparation. Any inspection should consider:

- *Selection of the inspection team.*—Members of inspection teams vary depending on the needs and resources of the organization or dam owner, type of the inspection, results of the data review, and any special requirements.
- *Review of project data.*—The amount of available data may vary greatly. The extent of project data review and evaluation depends on the type of inspection to be conducted. After reviewing available documentation, a list of important and significant concerns should be prepared for use during the inspection. Typical documents that should be reviewed prior to an inspection include:

1. Technical record of design and construction.

2. Design summary.
3. Laboratory reports.
4. Stress model reports.
5. Materials investigations.
6. Geology reports.
7. Site seismicity reports.
8. Plans and specifications.
9. As-built drawings and topography/surveys.
10. Maps including those for site geology, landslides, USGS quads, land ownership, and wetlands.
11. Upstream and downstream areas.
12. Final construction report.
13. Construction progress reports.
14. Maintenance records (e.g., drain cleaning reports).
15. Travel reports.
16. Correspondence files.
17. Operation and maintenance records.
18. Instrumentation records.
19. Examination reports (including any previously outstanding recommendations).
20. Designers' operating criteria.
21. Standing operating procedures.
22. Reservoir operation records.

23. Data books.
  24. Dam logbook.
  25. Emergency action plan.
  26. Job hazard analysis.
  27. Special land use information including archaeology, environmental, and tribal socio-religious concerns.
  28. Emergency response reports.
  29. After-action reports (i.e., of actual events).
  30. Historical information of operational problems/occurrences and performance during extreme events. Historical information could come from local media, newspaper records, government offices, historical societies, and town or county offices.
- *Preparation of an inspection plan.*—A detailed inspection plan should be prepared to identify all features to be inspected, problem areas, and areas of potential problems. The inspection plan also identifies special logistics, access, or equipment requirements. An inspection checklist is typically prepared as part of an inspection plan. The checklist is used to identify specific inspection objectives and is also useful in developing the final inspection report. The inspection team should also meet with those familiar with the dam and discuss any outstanding issues.

A log should be established at the dam that records the date, type of inspection performed, name of the inspectors, and the results. All inspections should be documented in the form of an inspection report with photographs, reservoir water levels, discharges from the outlet works, and relevant data from instrumentation, such as nearby piezometers. The report should be forwarded to the engineering staff or personnel responsible for technical review and evaluation. An ongoing visual inspection checklist should be developed to provide guidance and consistency in looking for signs of distress. If information is found that suggests the dam, foundation, or outlet works was not designed to current standards, specific items should be added to the inspection checklist to address specific deficiencies. All inspection reports should be maintained in a secure location for future reference. Good recordkeeping of inspection reports, technical reports, etc. ensures that development of any adverse trends are identified and proper actions are taken to correct any problems.

For further guidance on inspection programs and checklists for inspection, see [Reclamation's \*Review of Operation and Maintenance Program Field Examination Guidelines\* \(1991\)](#).

A job hazard analysis should be prepared for dam and dissipation structure inspections, following approved safety guidelines. The basic elements of a JHA are outlined in [Reclamation's \*Safety and Health Standards\* \(2009\)](#). Other agencies and organizations may utilize their own set of standards for safety guidance. All personnel involved in the inspection should receive and review a copy of the JHA. As a minimum, a JHA should include:

- Names of all participants and the agency, organization, or group they are representing.
- Operations to be performed.
- Special considerations, such as monitoring of atmospheric conditions prior to entry into confined spaces. Detection of adverse atmospheric conditions at any location requires that the confined space be mechanically ventilated or the examination be abandoned. Entry should only proceed upon confirmation of acceptable atmospheric conditions. All entrants into confined spaces are to have lockout/tagout and confined space entry training and should wear an approved body harness as required based on identified hazards to facilitate extraction of personnel should they become incapacitated.
- Potential hazards associated with the confined spaces defined previously are engulfment by water; oxygen deficiency; walking/working surfaces; electrical hazards; lighting; poisonous gases; molds, mildews, and spores capable of irritating the respiratory system; potentially harmful animals (e.g., rodents, snakes, spiders and/or insects, or crayfish); and other hazards. Heat can be another concern especially if Tyvek suits and respirators are required in a hazardous environment. Also, inspection team members should inform others if potentially serious health issues exist such as diabetes or heart ailments.
- Mitigating measures.
- Hazards and solutions.
- Health concerns of inspection participants.
- Safety-related equipment, such as hard hats, safety boots, proper clothing, gloves, communication equipment, oxygen/gas detection meter, mechanical ventilation equipment, flashlights, first aid kit, rubber boots, safety lines and harnesses, extraction/hoist equipment, and eye protection.

- Safety standard requirements.
- Available onsite communication strategy.
- Emergency services.
- Signatures of the inspection team members indicating that they have reviewed the JHA and have been instructed in and understand the requirements and hazards associated with the entry into confined spaces for the purpose of conducting this examination.

Upon completion of the inspection, all participants should discuss the inspection to identify what could be improved in the JHA for the next time. Any findings or recommendations should be documented for inclusion in future JHAs. Any mishaps or near misses should be identified during the postinspection discussion.

A dive plan or dive hazard assessment should be prepared prior to any dive inspection. Most commercial diving companies have their own dive plans. Guidance on dive safety can be found in [Occupational Safety and Health Administration \(OSHA\) Standards 29 CFR, Subpart T, \*Commercial Diving Operations—General Industry\* \(2004\)](#), and the [Association of Diving Contractors International's \(ADCI\), \*Consensus Standards for Commercial Diving and Underwater Operations\* \(2004\)](#). Various government agencies have guidance on dive safety, such as [Reclamation's \*Safety and Health Standards\*, Section 29, "Marine and Diving Operations" \(2009\)](#).

### 11.5 Performing the Inspection

Methods used for the inspection of the dissipation structure mainly depend upon accessibility. Factors influencing accessibility include:

- *Inundation*.—Reservoir operations and water levels may make some features unavailable for normal inspection and require specialized inspection services (e.g., dive team, closed circuit television, remotely operated vehicles), or unwatering.
- *Confined space*.—Certain features may require OSHA confined space permitting for man-entry, lockout/tagout procedures, and preparation of a JHA. An alternative to man-entry is the use of specialized inspection services (i.e., closed circuit television, remotely operated vehicles).
- *Size constraints*.—Limitations in size may prevent man-entry and require specialized inspection services (i.e., closed circuit television, remotely operated vehicles).

When performing an inspection, the inspector must understand how the dissipation structure should perform during operation, so that areas likely to be damaged can be thoroughly examined. Improper operation can result in erosion at the downstream end of the structure, causing loss of foundation support. Unusual water currents, eddies, and swirls may carry rock and debris into the dissipation structure.

When a basin cannot be unwatered, the inspector may need to record soundings from a boat. Surveying equipment may be needed to determine the location of subsurface damage. When damage is suspected, underwater inspection may be required to substantiate the degree of damage.

Since these structures reduce velocity and dissipate energy in the flow, damage can occur to all components. Typical problems include (Reclamation, 1988, p. IV-73):

- Deterioration of materials:
  1. *Concrete*.—Concrete surfaces should be visually examined for damage from cavitation, abrasion erosion, unusual or extreme stresses, reinforcement corrosion, spalling, weathering, alkali or other chemical attack, vandalism, and other destructive forces. Areas of concern include:
    - a. *Cavitation*.—The sides of chute blocks, baffles, and dentates are exposed to considerable turbulence, and any offsets or irregularities can initiate damage from cavitation. [Figure 145](#) shows a flip bucket invert that has sustained cavitation damage.
    - b. *Abrasion erosion*.—Abrasion erosion of flow surfaces is the most frequent problem associated with energy dissipators. This problem commonly occurs on the flow surfaces of hydraulic jump stilling basins, but isolated cases of this have occurred at other types of energy dissipators, too. Abrasion erosion can occur for discharges much smaller than the design discharge, especially where a high tailwater causes the jump to form on the sloping chute approach to the horizontal floor of the basin. In hydraulic jump stilling basins, circulation of rocks, gravel, sand, construction debris, or other materials has caused abrasion erosion. The main sources for these materials to enter the basin are rock slopes behind the basin walls and visitors throwing debris into the basin. In some cases, the abrasive materials may come from the reservoir itself. Some hydraulic jump basins are more prone to circulation of these materials in the basin rather than sweeping or flushing them out. Reasons for this include ([Jansen, 1988, pp. 701–702](#)):





Figure 145.—The invert of this flip bucket sustained significant cavitation damage during operation.

- Tendency of vertical plane eddies to carry abrasive materials from the outlet channel back into the basin.
- If several outlets are being used, nonsymmetrical discharges may cause large horizontal eddies to carry outlet channel material back into the basin.
- The hydraulic jump violently circulates any abrasive material in the basin.
- Most hydraulic jump basins are not designed to be self-cleaning.

Circulation of abrasive materials results in erosion of the flow surfaces that, in some cases, has been many feet in depth. Abrasion erosion continues until the materials are removed from the basin. Floors, walls, chute blocks, and dentates can be exposed to erosional damage from materials suspended in the flow. Abrasion erosion is evidenced on floors and walls by a circular grinding pattern. Steel reinforcement can become exposed leading to corrosion and loss of flexural strength. Even if abrasion erosion does not cause a failure, it can greatly affect other failure modes such as damage from cavitation. Studies by Reclamation seem to indicate that the type II basin may be

more prone to pulling debris into the basin by back circulation than other basin types. However, the type III basin also experiences back circulation. Figures 146 and 147 show examples of abrasion erosion damage. Figure 148 shows concrete that has been eroded due to waterborne debris. The Clark Canyon case history in the appendix illustrates how materials in the stilling basin can cause erosional damage when the basin operates.

Inexperienced inspectors may have difficulty in distinguishing abrasion erosion from cavitation damage. Abrasion erosion is usually characterized by a relatively smooth and polished look, especially to the aggregates. Cavitation damage is usually much rougher, and can start as a small area of damage and progress to larger areas of damage in the downstream direction.

- c. *Cracking*.—Cracking in concrete is usually the first visible sign of distress. Concrete can exhibit many different types of cracking. Not all cracks are serious, but cracks should be monitored since they can provide openings in the concrete that allow other types of deficiencies to develop. Items to consider when evaluating a

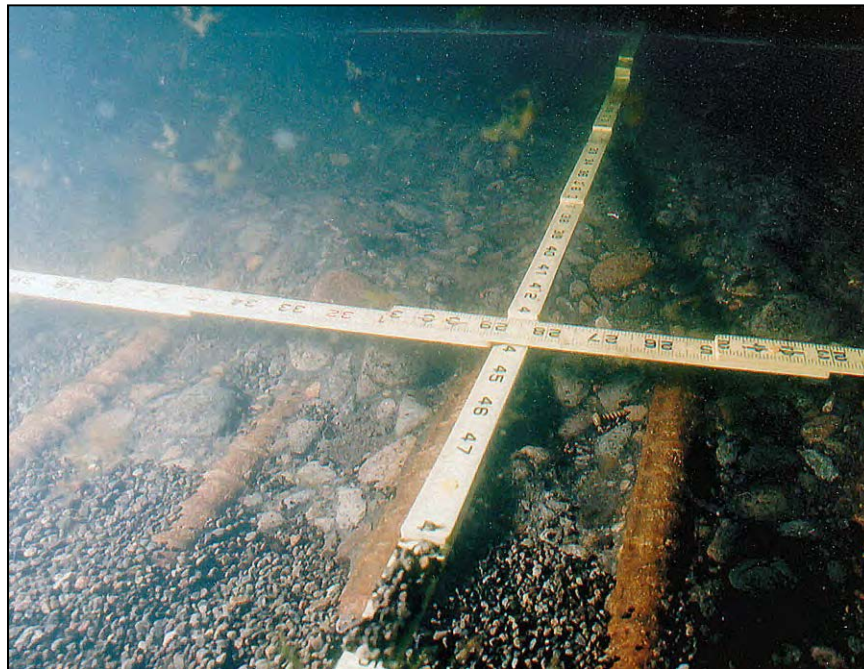

Figure 146.—A dive team inspection revealed significant concrete damage and exposed reinforcement on this stilling basin floor caused by abrasion erosion.



Figure 147.—Abrasion erosion damage at a dentate block.



Figure 148.—Eroded concrete caused by abrasion.

suspected structural crack are the concrete thickness, the size and location of the reinforcing steel, the type of foundation, and the drainage provisions for the structure. Deep, wide cracking is due to stresses that are primarily caused by structural loads. [Figure 149](#) shows an example of a wall that has experienced structural cracking. Shrinkage and concrete quality cause minor or hairline surface cracking. The results of this minor cracking can be the eventual loss of concrete, which exposes reinforcing steel and accelerates deterioration. Generally, minor surface cracking does not affect the structural integrity and performance of the concrete structure. Cracks through concrete surfaces exposed to flowing water may lead to the internal erosion or piping of foundation soils from around

and/or under the dissipation structure. Chute blocks and dentates are cracked, loosened, or removed by ice during low winter flows.

- d. *Joint movement.*—Wall and floor joints can experience cracked, loosened, deteriorated, or missing joint filler (figure 150) or waterstops from flow, spalling, settlement, ice loadings, or backfill. Movement of adjacent floor slabs can allow water to be directed into the joint during high velocity flow. This could result in excessive hydrostatic pressures underneath the floor slab causing it to heave or crack, which increases the potential for accelerated deterioration and undermining.
  - e. *Corrosion.*—Reinforcement can become corroded or damaged from abrasion erosion and cavitation (figure 151) if the protective cover is removed. Rust stains that are noted on the concrete surface may indicate that internal corrosion and deterioration of reinforcement steel is occurring.
2. *Steel linings.*—Steel linings should be examined for erosion damage from cavitation and abrasion, corrosion, pitting, warping/deformation, fatigue, tearing, and ruptures.
  3. *Riprap displacement.*—Riprap can be moved or lost during high flows. Voids may be left when the riprap is removed and the underlying bedding and foundation material eroded.
  4. *Geotextile.*—Geotextile should not be exposed to direct flow or sunlight. Geotextile should be examined for tearing (during construction) or foundation movement.

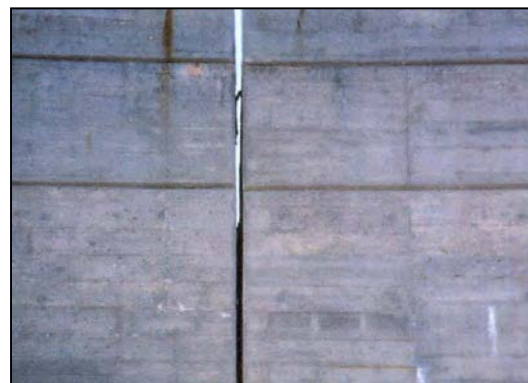

Figure 149.—Vertical crack in wall. Figure 150.—Loss of joint filler in a wall joint.





Figure 151.—The protective concrete cover has been removed exposing the reinforcement.

- Obstructions:
  1. *Debris*.—Baffles and basin appurtenances can become clogged with trash and other debris.
  2. *Material buildup*.—Return currents can bring downstream materials into the dissipation structure resulting in buildups that can affect discharges.
  3. *Vegetation*.—Heavy vegetation, such as thick grasses and cattails, can grow in plunge basins.
  4. *Thrown objects*.—People throw rocks and other objects into structures.
  5. Snow and ice dams.
  6. Beaver dams.
  7. Manmade structures.

- *Misalignment.*—Deflection of wall or floor due to differential settlement, loading, or poor design/construction. Movement can be small scale (differential) or large scale (dislocation of entire structure). [Figure 152](#) shows an example of wall joints that have experienced displacement.
- *Malfunctioning drains or weep holes.*—Drains in walls and beneath floors can become filled with sediments, organic materials, iron bacteria, or calcium carbonate deposits, or become infiltrated by fines, or blocked by debris ([figure 153](#)). Foundation movement can damage drains making them incapable of normal operation. Flows from underdrains should be observed and measured. Cloudy flows may indicate that internal erosion is occurring beneath or adjacent to the concrete structure, which may affect foundation support. Weep holes in the concrete are used to allow free drainage and relieve excessive hydrostatic pressures from building up underneath the structure. Weep holes in walls should be checked for the accumulation of silt and granular deposits. These deposits may obstruct flow or indicate loss of support material behind the wall.



Figure 152.—This vertical wall joint has experienced a 2-inch offset.





Figure 153.—Debris deposited around a chute block.

- *Backfill and foundation deficiencies.*—Cracks or settlement in backfill (figure 154) may indicate the existence of voids and erosion channels. Settlement of the floor can affect the performance of the hydraulic jump. Foundation deficiencies can also expose cutoff walls. Tapping the concrete surface with a hammer or some other device helps locate voids if they are present, as well as give an indication of the condition and soundness of the concrete. This can also be an indication of delamination occurring in the concrete. Loss of underlying soil or lack of filter action can undermine riprap. Sand or gravel lining beneath the plunge basin can be subjected to erosive conditions.
- *Expansive foundation.*—Expansive clay or clay-shale foundations are subject to heaving and misalignment across joints.
- *Excessive seepage.*—Materials can be moved and soils saturated causing the structure to shift or collapse.

Inspection of the outlet channel should also be performed in conjunction with the energy dissipation structure. If the outlet channel fails to properly function, excess flow could result in damage to the dissipation structure or downstream toe of the dam.



**Figure 154.**—A sinkhole developed next to this basin wall indicating internal erosion of foundation materials was occurring.

## 11.6 Specialized Inspection

When the inspection cannot be performed using typical methods, specialized inspection may be required. Specialized inspection includes the use of a dive team, climbing team, remotely operated vehicle (ROV), or closed circuit television.

### 11.6.1 Dive team

Underwater inspection is typically accomplished by scuba diving operations. Scuba diving equipment typically includes a breathing gas supply tank, which the diver carries (figure 155). This method of inspection can limit diver communication and should be limited to areas without overhead obstructions where the diver has an unobstructed path directly to the surface.



Figure 155.—A diver preparing to perform a stilling basin inspection.

Dive inspections are expensive, and costs are greatly influenced by the depth of the dive, the elevation at which the dive is performed, and the temperature of the water. All specialized inspections involve a number of variables. As a general rule of thumb, when comparing the costs involved with dive inspections to ROV or CCTV inspections, dive inspections are about 3 to 5 times more expensive.

A dive inspection has the advantage of using a variety of instruments for testing the structural integrity of the dissipation structure such as a rebound hammer for providing data on concrete surface hardness, a magnetic reinforcing steel locator to locate and measure the amount of concrete cover or reinforcement, and an ultrasonic pulse velocity meter to determine the general condition of concrete based on sound measurements. Dive inspections also offer the potential for hands-on, tactile inspection of features in limited visibility or those covered with shallow layers of organics or sediments (figures 156 and 157). The [Virginia Smith Dam case history](#) in the appendix discusses how dive inspection was used to discover damage in the stilling basin. Divers should pay special attention to the rock shape characteristics of any debris found in the stilling basin. Angular or sharp cornered rock often indicates that it has not been subjected to excessive tumbling action or “abrasion erosion.” Well rounded rocks generally imply considerable grinding. However, the possibility of rounded rocks thrown into the basin must also be considered. Rock coloration from abrasion erosion and degree of algae accumulation on rock deposits can also be





Figure 156.—A diver inspecting a baffle block.

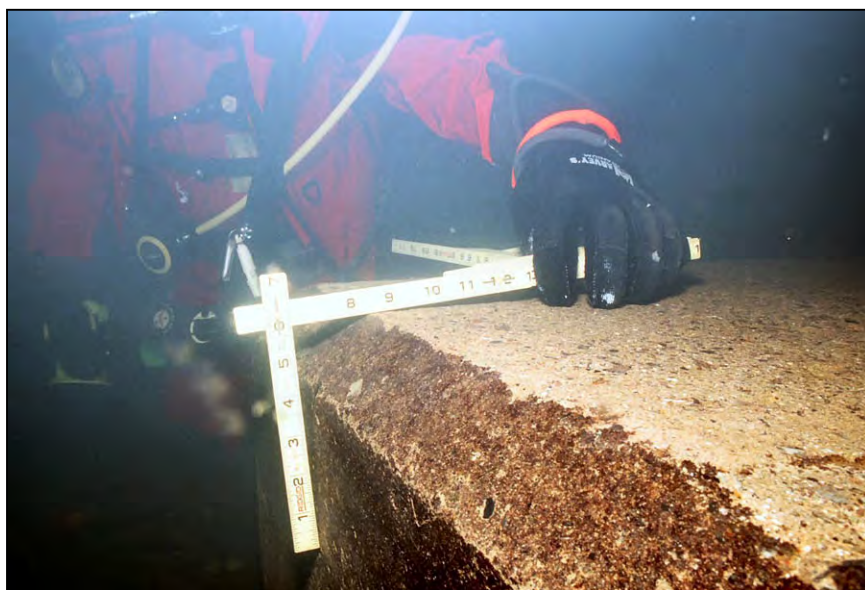

Figure 157.—A diver inspecting the chamfer on chute block.

indications of how static or dynamic the material is during operation of the structure. The location of rock deposits in the stilling basin can indicate how they entered the basin. Upstream currents can also pull rocks in and deposit them toward the upstream end of the basin. This rock is often grouped together. Rock located at the upstream end of the stilling basin resting on the chute blocks probably entered the basin by the outlet works. Hydraulic action may have pulled in rock located at the downstream end of the stilling basin (look for riprap missing immediately

downstream from the basin). People throwing rocks probably account for rock that is scattered about the stilling basin floor or in larger accumulations near the sides of the basin.

Some important considerations for any dive inspection are:

- *Qualification.*—All divers involved in a dive inspection should be professional divers trained in underwater inspection. Commercial diving contractors participating in underwater inspection should utilize certified commercial divers trained to meet the minimum requirements of the [Association of Diving Contractors International's \(ADCI\) Consensus Standards for Commercial Diving and Underwater Operations \(2004\)](#) through the training standard of an accredited Association of Commercial Diving Schools program. Many governmental entities maintain inspection dive teams for their various facilities. These teams typically consist of divers who have extensive training in the specific aspects of diving necessary to perform the required inspection work but not necessarily to perform many of the tasks associated with commercial diving such as welding or underwater construction. All divers should be trained in first aid and cardiopulmonary resuscitation (CPR) and be in compliance with OSHA standards.
- *Dive team.*—The dive team should, at a minimum, include the diving supervisor, a lead diver, and a backup diver for relief or emergencies. The diving team should have a dive master, whose primary talents are coordination of his crew and a solid understanding of what needs to be accomplished. Other members of the dive team should have a good understanding of the mechanical equipment and the functions that need to be maintained as well as solid experience with electronic equipment such as ultrasonic thickness gauges, underwater still cameras, and communication equipment. Great benefit can be derived from having an individual on the team who is experienced in the design/analysis/operations of hydraulic structures. All divers on the team should have the strength to accomplish the physically demanding tasks involved with the inspection.
- *Communication.*—Communication with a diver underwater is difficult. Everyone involved with the project needs to know the chain of command and what role each individual plays. All parties who may be involved with any portion of the diving inspection should fully understand the means of contact, both primary and secondary.
- *Safety.*—A specific job hazard analysis should be performed to address all aspects of the diving operation. The individual performing the hazard analysis should be in contact with the personnel who operate the facility to ensure all aspects of the structure and its potential energy sources are considered. All parties who may be involved with any portion of the diving inspection should

hold a kickoff meeting. Discussion should include the need for lockout tag-out (LOTO) procedures. A draft copy of the procedures should be provided to all attendees. The procedures should be finalized prior to commencement of any diving. No diving activity should start until the LOTO procedures are finalized, and all parties involved accept it.

Diving in an environment where the diver does not have a direct route to the surface is a very specialized area of diving. No clear-cut criteria exist for what divers can or cannot reasonably inspect. Diving has many inherent risks and should only be undertaken by trained professionals. Certain factors must be weighed against one another and a judgment made as to the viability of a dive inspection. Factors that must be considered include:

- *Depth.*—As the depth below the water surface increases, the difficulty of performing a dive increases. Divers have a limited amount of time on a given dive, and that time decreases with the increased pressures on deeper dives. In addition, as the dive becomes deeper, more of the allowable dive time is spent descending to the floor of the dissipation structure.
- *Altitude.*—The altitude at which the dissipation structure is located can greatly affect the viability of a dive inspection. This could really be considered a subfactor of the depth factor. Due to the lower atmospheric pressure at higher altitudes, the diver has even less bottom time for a given depth of dive.
- *Water temperature.*—As the water temperature decreases, it can have the effect of decreasing the dive time available to a diver. This is not necessarily a quantifiable variable as it relates to dive time. Often, the temperature effect can be mitigated to some degree by the level of thermal protection worn by the diver.
- *Size.*—As with depth, the dissipation structure's size becomes a factor relating to the amount of time the diver has available at depth. If the dissipation structure is extremely long and/or wide, it can take much more time to inspect than the diver has available. The available dive time for a long dissipation structure can be increased, but this can be costly.
- *Access.*—Some entrances into dissipation structures may present access issues. In these situations, it is important that a second diver be stationed underwater at the confined space entry point to tend the primary diver's needs.
- *Leakage and currents.*—The leakage of downstream valves or gates is a safety factor that can affect whether a dive inspection can be safely performed. Currents can be unpredictable. Any inspection of this type should be performed such that the diver enters the dissipation structure against any current and exits with the current.



- *Visibility.*—The distance a diver can see is important in determining whether a dive inspection of a dissipation structure is advisable. In poor visibility situations, divers can use their sense of touch for inspection. Sometimes a diver can use a hand to probe areas that cannot be seen. In the event of zero visibility, there would likely be little reason to pursue a dive inspection, because the entire surface of a dissipation structure would be extremely difficult to inspect by touch alone. If a dive inspection is planned, consideration should be given to making a large release prior to the inspection as a means of flushing sediments from the dissipation structure and allowing time for particles in the water to settle out prior to diver entry. This time depends on the type of sediments in the water but could vary from a day to a week. If visibility is good, the diver may want to use a high resolution hand-held video camera to document conditions. The video camera can be either self-contained or configured for topside viewing. A self-contained video camera is enclosed in a special waterproof case that allows for easy operation by the diver. For topside viewing, a cable is required from the camera to the monitor located on the top. The diver or topside personnel can provide narration during the recording. Video cameras can also be mounted on the diver's helmet. However, no matter how good the video camera's resolution is, if visibility is poor, the camera is only able to document a few square inches of surface at one time.

In certain situations, the combined use of divers and ROV or CCTV equipment may be required to complete the inspection. The divers are used to gain access and place the ROV or CCTV equipment in the proper location to continue the inspection.

### 11.6.2 Climbing team

A climbing team may be utilized to perform inspection of the inaccessible portions of dissipation structures ([figure 158](#)). Climbing inspections should always be performed in conformance with current OSHA guidelines. The inspection crew should have appropriate harnesses, helmets, boots, and secure tie-off points, including some redundancy in safety equipment.

The design of new structures, or rehabilitations of existing structures, should include provisions to facilitate future inspections. The incorporation of permanently mounted ladders, where appropriate, can increase the safety of future climbing inspections. In addition, permanently mounted tie-off points in the structure can be included in the construction work, eliminating the need to destructively anchor harness lines later.



Figure 158.—A climbing team preparing to perform a wall inspection.

### 11.6.3 Remotely operated vehicle

The ROV was first developed for industrial purposes to inspect oil and gas pipelines and offshore platforms. ROVs are now being utilized for underwater inspections of appurtenant structures and conduits.

The benefits of using ROVs for inspection include:

- Significant benefit/cost ratios compared to dive inspections. This ratio increases with more frequent ROV inspections.
- The ability to mobilize more quickly to conduct an inspection than a dive team.
- The ability to identify problems before they become chronic.
- The ability to aid in the design of solutions prior to scheduled maintenance or repair.
- Provides a visual record of what is observed.
- Can be used to aid divers in conducting inspections.

Some of the limitations of using an ROV for inspection include (USACE, 1995b, p. 2-15):

- *Two-dimensional.*—The ROV inspection provides only a two-dimensional view and does not project the full extent of any defect. If the dissipation structure is large, the ROV inspection is much more likely to be limited to one small path, whereas a diver can cover a much larger path or wider swath as the diver moves along the structure.
- *Visibility.*—Murky water limits the effectiveness of an ROV inspection. With an ROV in a limited visibility situation, the only area inspected is the small area directly in front of the camera. A diver can use their sense of feel, in a limited visibility situation and focus in on any problem areas.
- *Orientation.*—In some situations, it may be difficult to determine the exact orientation or position of the ROV. This can impede accurate identification of the area being observed. If any water currents exist in the stilling basin, this can be especially troublesome to the ROV. In addition, since ROVs often rely upon a compass, steel lining and/or concrete reinforcement can affect the navigation. If a CCTV camera-crawler is used in lieu of an ROV, the length of cable tether can be measured to determine the location.
- *Maneuverability.*—In some “tight” areas, the ROV may have more difficulty with maneuverability than divers would have in the same situation. Water currents can also affect maneuverability by causing the tether to become entangled.
- *Scale and measurement.*—Size or scale is difficult to interpret and precise measurements are not possible.

Commercially available ROVs are normally tethered to a surface power source via an umbilical cord, although untethered models are also available. ROVs that are tethered to the surface have cables that carry power and operation signals from the operator to the ROV. Most ROVs are equipped with at least a video camera and lights. Additional equipment can be added to expand the vehicle’s capabilities. These may include a still camera, a manipulator or cutting arm, water samplers, and instruments that measure water clarity, light penetration, and temperature.

An ROV consists of a high quality video unit, a power source for propulsion, vehicle controllers (referred to as “joysticks”), and a display monitor. The ROV can provide real-time viewing. Observations can be recorded onto videotape (VHS), DVD, or hard drive. Most ROVs are either observation or working class vehicles. An observation class vehicle is small and compact and is used for visual inspection where nonintervention applications are required. Typically, observation-class ROVs include a high resolution color video camera capable of zoom and manual or auto

focus. [Figure 159](#) shows an observation-class ROV entering the water. Precision color scanning sonar is an added option, but can be expensive. Some observation class ROVs may have a single function manipulator. Working class ROVs are typically capable of search, survey, inspection, and light intervention to depths up to 2,000 feet. Working class vehicles can typically support a payload capacity to allow for the attachment of sophisticated accessories. Most working class ROVs have multifunction manipulators. ROVs typically range in size from 10 to 160 pounds depending upon payload and features. In most cases, depending upon the size of the vehicle, one or two people can deploy an ROV.

An operator or “pilot” controls the vehicle from the surface. Using a joystick, a camera controller, and a video monitor, the operator moves the ROV to the desired location. The operator’s eyes essentially “become” the camera lens. The vehicle’s depth and heading can be recorded. A global positioning system is generally not available on most ROVs and is an expensive and complicated added feature. Joysticks are used to control the propulsion and manipulation of the ROV and any accessory equipment. ROVs typically have three thrusters, two horizontal and one vertical. The thrusters allow the vehicle to move forward and backward and to turn left and right. Some ROVs may have a fourth thruster mounted horizontally for lateral movement.

ROVs are capable of accommodating various attachments (e.g., pincer claw) for grasping, cleaning, and performing other inspection tasks. However, the addition of attachments requires larger ROVs to accommodate the attachments. Specially designed ROVs can accommodate and operate nondestructive testing equipment. In the event that diving is impractical or prohibitively expensive and unwatering of the dissipation structure is not economically or technically practical, an ROV can be utilized. ROVs can compensate for the limitations inherent in underwater inspections performed by divers, since they can function at extreme depths and water temperatures, are not affected by altitude concerns, can remain underwater for long durations, and repeatedly perform the same tasks without sacrifice in quality. In addition, the costs involved for ROV inspection are considerably less than for dive inspection or unwatering of a stilling basin. Inspection by ROV may be preferable in certain situations prior to performing a dive inspection. This is especially important in regards to safety. An ROV that is damaged or destroyed can be replaced. This is in no way comparable to the loss experienced when a diver is injured or killed. The easy deployment of an ROV can encourage inspections that are more frequent.



**Figure 159.**—An observation-class ROV entering the water to begin an inspection.

Caution is advised when performing an ROV inspection. The ROV operator should be qualified, experienced, and knowledgeable about the hazards involved. The potential exists for the ROV to become entangled in its umbilical cable or the umbilical cable can become entangled within debris. However, the learning curve to acquire the necessary skills and abilities to proficiently operate an ROV is short. With some modest training, operators should easily be able to operate and maintain an ROV system.

The technology associated with ROVs is continually evolving. Continued advancements (such as acoustic positioning) will allow the operator to overcome some of the existing ROV limitations by utilizing more sophisticated attachments and instruments to improve diagnostic capabilities.

### **11.6.4 Closed circuit television (CCTV)**

CCTV is very useful for examining small or inaccessible conduits and pipes (outlet works and toe drains) and has some applicability for examining energy dissipators where risks, costs, or system complexity may make remote inspection more advantageous than other methods of inspection. CCTV is especially useful for inspecting structural underdrains for damage or obstructions ([section 2.6.6](#)).

CCTV inspection provides mobility and provides real time video images that can be especially useful where confined space entry issues may require permitting prior to



man-entry. OSHA regulations define a confined space as having limited access and egress, and not being designed for continuous human habitation.

Generally, a CCTV inspection consists of a video camera attached to a self-propelled transport vehicle (crawler). Some crawlers utilize tracks, and others use wheels. The transport vehicle and camera are commonly referred to as a camera-crawler (figure 160). An operator remotely controls both the transport vehicle and camera. The camera can provide both longitudinal and transverse views of surfaces. Video images are transmitted from the camera to a television monitor, from which the operator can view the underwater conditions. The video images are recorded onto videotape or DVD for future evaluation and documentation. The operator can add voice narrative and text captions or notations as the inspection progresses.

Depending on the model, the cameras have pan, tilt, and zoom capabilities, a wide range of tether pulling capacity (200 to 1,500 feet), and steering capabilities. Actual tether limits obtainable in the field vary greatly, depending upon a number of factors, such as invert slopes and existing invert conditions, such as sediments, mineral encrustations, and bacterial growths.

If required, some models of camera-crawlers allow for the attachment of retrieval tools, such as alligator clamps, grippers, and magnets. These tools can be used to remove light debris or damage. The attachment of any type of retrieval tool requires additional clearance to operate the retrieval tool. Some models of crawlers have robotic cutters attached to them. These cutters can be used to remove debris or protrusions in concrete, steel, or reinforcement. Most camera-crawler systems are portable and can be carried to access locations. The use of an all-terrain vehicle (ATV) may be beneficial for transport of equipment in difficult access areas.



Figure 160.—A camera-crawler used for CCTV inspection.



Sometimes certain features of the dissipation structure may be too small (e.g., an underdrain) and a transport vehicle cannot be used, or obstructions/invert conditions exist that prevent its use. For these types of situations, a small color video camera (1.5 to 3 inches in diameter) with maximum pressure depth ratings up to 1,000 feet of water can be used. [Figure 161](#) shows an example of this type of video camera. This video camera can be attached to metal or PVC poles (commonly referred to as push poles) and manually pushed up the structural underdrain pipe. Push poles are normally used for straight sections of pipe. The use of push poles for advancement is generally limited to about 400 feet of length. If bends exist in the pipe, a flexible snake device (spring steel wire, coiled wire, or flexible polypropylene-jacketed fiberglass push rod) can be used instead of the push poles. A coaxial cable connects the video camera to a VHS or DVD recorder and television monitor. Snake devices are generally limited to about 75 to 200 feet of length. The [Twin Lakes case history](#) in the appendix describes the use of a small CCTV camera to inspect an outlet works stilling basin underdrain system.

The quality and adaptability of CCTV inspection equipment can vary greatly, depending on the requirements of the inspection. Any company or contractor selected to perform a CCTV inspection should have a wide range of available equipment for differing site conditions. No CCTV inspection equipment exists that is fully adaptable for all conditions, and a variety of crawler configurations and cameras may be required to accommodate differing pipe diameters, invert slopes, and pipe loads. Refer to [section 2.6.6](#) for guidance on designing underdrains to accommodate CCTV equipment.

Camera-crawler inspection equipment is expensive to purchase, operate, and maintain. The environment being inspected is often harsh and can pose many hazards and obstructions. Although rare, camera-crawler inspection equipment can become lodged in small underdrains, if adverse offsets or obstructions exist. If camera-crawler inspection equipment becomes lodged within a pipe, it can block or reduce its discharge capacity. In addition, due to the harsh environment, this type of inspection equipment can experience breakdown while operating. The retrieval process for removing a lodged camera-crawler can be expensive and time consuming. If the camera-crawler inspection equipment becomes stuck in totally inaccessible portions of an energy dissipator, complete abandonment and loss of the equipment is possible. For this reason, the operator of any inspection equipment must be very experienced and have a clear understanding of the capabilities and limitations of the equipment. The operator must be very cautious and should not push the equipment beyond retrievable limits. The ability to recognize inspection limitations is based largely on the operator's skill and prior experience. The operator must have a thorough understanding of potential dam safety defects, materials, and obstructions. A conservative approach to inspection is best advised.

A successful CCTV inspection depends upon the quality of the equipment and the experience of the operator. A CCTV inspection usually requires a two-person crew



**Figure 161.**—Small video camera that can be attached to PVC or metal poles and manually pushed into underdrain pipes.

consisting of an operator and cable reel handler. Additional crew members may be required in difficult access locations.

### 11.6.5 Soundings

Soundings are useful in areas that cannot be unwatered regularly because of economics (e.g., a large basin with high tailwater that is always high). Soundings could also be used downstream from the structure or in plunge pools to help monitor any unexpected or excessive erosion. Soundings conducted by dragging a hooked chain may also be useful in determining if reinforcing steel has been exposed by erosion.

### 11.6.6 Sonar

If unwatering a basin is not feasible, sonar may be useful to gather information concerning the conditions beneath the water surface. Sonar uses sound waves reflecting back from a basin surface to collect information related to the amount of debris or damage existing in the structure. In addition, sonar can be beneficial for downstream erosion mapping.

Divers are frequently used in inspection, maintenance, and repair of stilling basins. However, in turbid water, the lack of visibility severely reduces their effectiveness

and subjects them to potentially dangerous operational conditions. In addition, the diver must wait until he returns to the surface before sketching what he saw or felt with his hands while underwater. Inspection using sonar may have some application for use in underwater examination of stilling basins. Small sonars can also be deployed on ROVs.

The benefits and savings of sonar include the following:

- Expedites construction, repair, and maintenance of underwater structures.
- Provides safer conditions for personnel engaged in wet construction and inspection activities.
- Enables the user to log underwater images from inspections immediately and permanently.
- Allows for detection and evaluation of damaged areas.

Several different ROV types of underwater sonar exist for varying applications:

- Single-beam sonar is for depth sounding and consists of a single transducer with a single element. If the structure is known to be clear of debris, soundings may detect adverse settlement of the structure, as well as the presence of relatively large areas of abrasion erosion damage (on horizontal surfaces). Small areas of abrasion erosion damage might not be detected by soundings, depending on the grid spacing of the soundings.
- Multibeam sonar is used for mapping the bottom surface and for fish counting. As the name implies, it consists of several elements within a single transducer.
- Side-scan sonar is used for mapping the bottom surface. This consists of two transducer arrays mounted horizontally on a platform creating a fan-shaped beam that images a large swath of bottom surface on both sides of the platform. The USACE's ERDC has been using side-scanning sonar to help with inspections on navigation structures normally underwater. Side scanning sonar creates an image of an area. Results generally are not conclusive.
- Acoustical imaging sonar is used for inspecting structures and identifying objects. This consists of a multi-elements array and produces either a two- or three-dimensional image with high resolution. Acoustical imaging had its genesis in the medical industry for detecting and evaluating various abnormalities of the body. While these medical acoustical imaging systems operate in the 5- to 10-MHz frequency range, may consist of several hundred channels, and may be arranged in a one- or two-dimensional array, present-day

units designed for underwater applications consist of fewer channels and operate at a maximum frequency of 3 MHz. Some acoustical cameras allow the operator to use both a high and low frequency. The lower operating frequency allows some underwater imaging cameras to obtain images out to 300 feet or better at the expense of being able to see small objects; but the higher operating frequencies allow users to see objects that are on the order of 0.4 inch wide at a distance of 3 feet from the camera.

- In general, an underwater acoustical imaging system includes the imaging camera, a computer to display and store the data, and a platform, including a pan and tilt device, on which to deploy the system. The imaging system may be deployed by a boat, ROV, or d position mounts (figures 162 and 163).
- In order to achieve high resolution and high speed at reasonable size and cost, acoustical imaging systems produce smaller viewing windows. Consequently, the user is best served with an image mosaicing capability to increase the image size and provide some filtering for the random noise that is present in ultrasonic systems. Figure 164 shows an example of a mosaiced image. The only requirement for mosaicing images is a stable mounting platform, so the water surface conditions need to be somewhat calm.



Figure 162.—Interior of a USACE boat equipped for surface deployment of an acoustical imaging system.



Figure 163.—Acoustical imaging camera mounted with pan and tilt mechanism.

### 11.6.7 Unwatering a dissipation structure for inspection

Prior to unwatering a basin for inspection, the resistance of the basin to hydrostatic uplift should be analyzed. For a normally inundated structure, the groundwater level around the structure commonly matches that of the level of the pool within the basin. Removal of the pool within the basin prior to lowering the adjacent groundwater will create an upward force on the structure, potentially destabilizing the structure. Measures should be taken to ensure the self-weight of the structure is sufficient to resist this uplift. Alternatively, the water could be removed from the basin slowly, allowing the adjacent groundwater to drop in tandem. In addition, the surrounding groundwater could be pumped down prior to unwatering the basin. Provisions may also be required for preventing tailwater from reentering the basin through the underdrain system.

Unwatering of a basin subjects the underdrain system of the structure and the surrounding soil (native or placed fill) to seepage gradients as the groundwater levels equalize to the new lower level of the tailwater. In the event of rapid unwatering, this can result in gradients that greatly exceed the original design. For instance, pumping out 15 feet of tailwater from a shallow basin in 8 hours would be the equivalent of 45 feet of drawdown in a 24 hour period, which is well above anything a dam would be subjected to except in an emergency condition. While these failures are typically localized, it is unknown if other unseen damage may occur. These extreme gradients are also occurring within the underdrain system beneath the basin



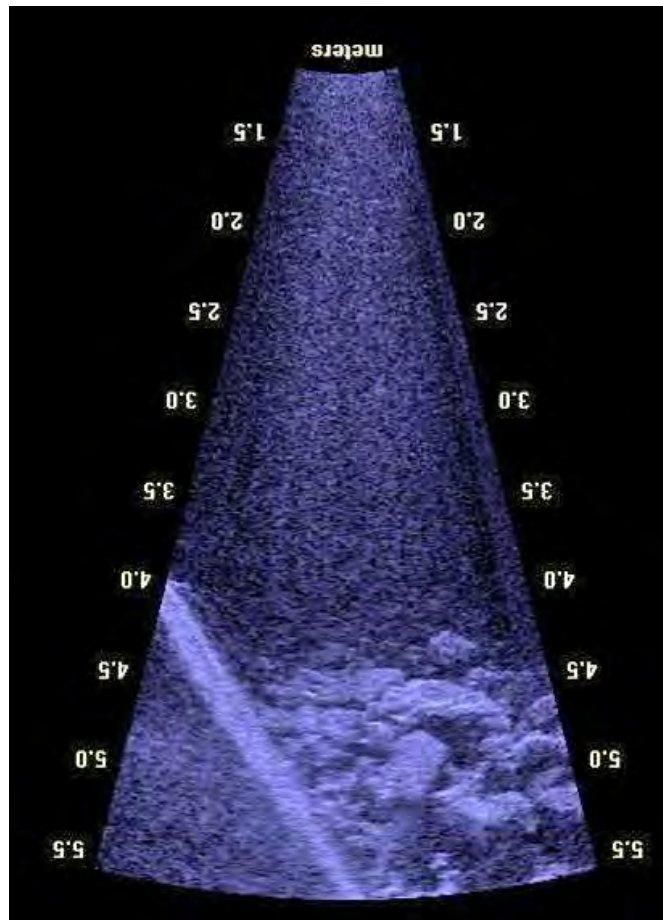

Figure 164.—Inspection of stilling basin for abrasion erosion using an acoustical camera. Rock can be seen lying on the stilling basin floor.

and this can result in undue pressure on the system. In the last 6 years, underdrain system failures have occurred or were detected at several Reclamation facilities. While not all of these structures were unwatered, several were. Unwatering alone is not likely to have caused these failures, but it may well have been a major contributing factor. Many basins exist that were undoubtedly not designed to be unwatered, at least not with inoperable underdrains. However, many basin underdrains are plugged by organic materials and no longer offer any relief of the groundwater beneath the basin. This can create an uplift failure potential during an unwatering activity, even when previous unwatering activities were fine because the drains were not yet fully plugged.

Measures for unwatering dissipation structures should be incorporated into the design of new basins (or rehabilitations of existing basins). These measures include providing sufficient self-weight of the structure to resist uplift, well designed underdrain systems, and provisions to accommodate temporary structures that may



be used in the unwatering process, such as stoplogs. If stoplog slots are not provided, other means of utilizing stoplogs need to be considered. [Figure 165](#) shows a situation where stoplog slots were not available and an improvised stoplog had to be installed at the downstream end of the basin. [Figure 166](#) shows an example of a cofferdam used to keep the work area dry. An alternative to the traditional earthen cofferdam is the use of a polyethylene baffled bladder dam ([figure 167](#)).

When the cost of unwatering is excessive, it could possibly be delayed by performing dive inspections instead. In addition, if the structure has not been used extensively or has not seen significantly larger flows than normal, the inspections may possibly be made less frequently. Inspections requiring unwatering should be scheduled to coincide with any needed cleaning of the basin. The [Norman Dam case history](#) in the appendix discusses a stilling basin unwatering which contributed to a slope failure.

### 11.6.8 Cleaning of dissipation structures

Silt and sand deposits are common in many stilling basins. These deposits can enter the stilling basin directly from the intake structure, through underdrains, by water surface runoff into the basin, or by wind. If the deposits become too deep, there is concern whether flow will overtop the basin walls. Methods available for cleaning the basin can be expensive and in many cases the deposits may likely form again.

Reasons for cleaning a dissipation structure include:

- To allow for inspection within the dissipation structure.
- As part of the selected renovation method.
- To improve the flow capacity due to hard deposits, bacterial growths, sediments, or debris that may have collected in the dissipation structure. Periodic operation flushes out many of these types of collections. However, infrequent operation or nonoperation may allow for continued buildup of these collections.
- Removal of abrasion erosion materials before they cause damage.

#### 11.6.8.1 Cleaning Methods

A variety of cleaning methods are available, but each varies as to the level of effort required and costs involved:



Figure 165.—Divers assisting with the installation of stoplogs at the downstream end of a stilling basin. Turnbuckles were attached to the stoplogs and basin. These held the stoplogs against the end of the basin walls until the basin was unwatered and the outside water pressure kept them in place. Rubber seals on the stoplogs prevented leakage.



Figure 166.—Cofferdam constructed to keep the basin area dry for repairs.



**Figure 167.**—A polyethylene baffled bladder dam is being placed downstream from a stilling basin. The dam is 250 feet long by 19 feet wide by 8 feet high. The dam weighs 2,600 pounds (dry). Two 3-inch pumps (8 hp) and two 3-inch pumps (4.5 hp) were used to fill the dam with 150,000 gallons of water. The dam took about four hours to deploy (watering up and rolling out the dam). Upon removal, the dam took 2 hours of dewatering and 2½ hours to roll up and remove. Removal of the dam required the rental and use of two track-hoes for rolling up the dam on a log.

- *Flushing.*—Flushing using discharge from the outlet works is often an economical method for cleaning a stilling basin. Flushing tests should begin at a low discharge and progress to higher discharges as needed for removal of sand and sediments. Increases in discharge should be gradual and include specified hold periods to avoid any damage to the stilling basin. In stilling basins with thick deposits of firm clay, flushing may not be completely effective and the use of a clamshell equipped crane may be required to remove deposits remaining at the downstream end of the basin.

Usually, for a type II stilling basin, cleaning requires a flow of at least maximum design discharge for materials to be flushed from the basin without being carried back in again. [Figure 168](#) shows the flow pattern (and rocks being pulled in) that can develop during normal operation of a hydraulic jump stilling basin. When the jet lifts off of the basin floor, flow near the bottom is pulled upstream creating the recirculating flow pattern. For type III stilling basins, materials can be pulled in at all discharges because the basin baffle blocks force the jet off of the basin floor. For type IV basins, there is not much documentation of abrasion erosion damage. Since these basins are designed for

Froude numbers between 2.5 and 4.5, the hydraulic jump is not fully developed and they may be less likely to bring materials in. Model studies would need to confirm this.

- *Dredging.*—A clamshell equipped crane can be used to remove sediments.
- *High pressure wash.*—High pressure spray wash can be used to loosen and move deposits. Another method is required to physically remove the debris from the stilling basin. High pressure jetting has also been used to clean sediments, deposits, and organics from structure underdrains. Extreme caution and the lowest pressure needed should be used to avoid damaging the underdrain system.
- *Removal by hand.*—Small amounts of debris (tree limbs, small rocks, etc) can be removed by hand.

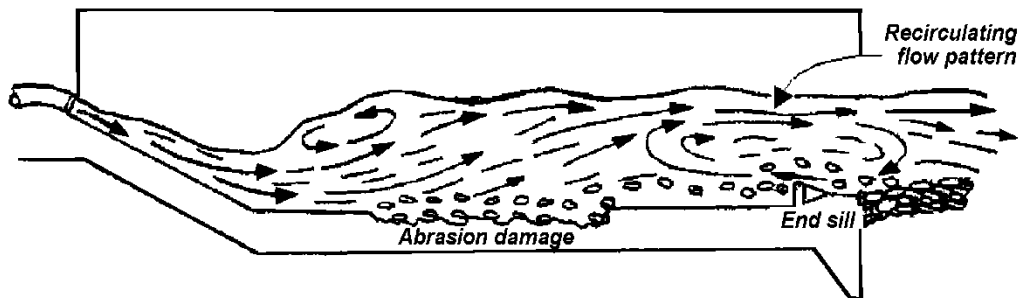

Figure 168.—Recirculating flow pattern pulling rocks into the basin.





## Chapter 12

# Maintenance and Repair

Most outlet works energy dissipation structures are or at least partially constructed with concrete. Valves and gates are made of various other materials, but repairs tend to be done by the manufacturer. Since most energy dissipation structures are concrete and suffer from various forms of causes, this chapter focuses primarily on maintenance and repair of concrete structures that remain submerged or partially submerged most of the time.

Various causes of outlet works energy dissipation damage requiring repairs are cumulative in nature. If not addressed, these causes could lead to erosion or loss of concrete floors or walls leaving the structure to more erosion and eventual undermining of the entire structure. Depending on the nature of the dam (earthen, rock, concrete) and the foundation (soil or rock), loss of the energy dissipator could lead to slope instabilities, compromised seepage defenses, or backward erosion through the dam. To determine if these potential failure modes are a concern for the dam under study, refer to the end of [Chapter 1](#) for more information on Potential Failure Modes Analysis and risk informed decisions.

The maintenance and repair of energy dissipators that are either partially, completely, or periodically under water present many complex problems. Many energy dissipators are kept in operation well beyond their original design lives. Experience has shown that many of these older structures require significant maintenance, repair, and rehabilitation ([McDonald and Campbell, 1985](#)). Although damage to older structures frequently occurs, newer structures are not immune to problems. Newer structures have not experienced flows at design levels and often have not had their design or construction weaknesses revealed. The annual cost to owners for repair, rehabilitation, strengthening, and protection of concrete structures in the United States has been estimated to be between \$18 billion and \$21 billion ([Strategic Development Council, 2006](#)). Energy dissipators must be properly maintained to ensure their continued operation and that repairs, when needed, be made as efficiently as possible while addressing the cause of the problem, rather than just the symptom presented, to prevent recurrence of the problem. Effective ongoing maintenance is best achieved by developing a formal inspection and maintenance program for the structure that documents future requirements, identifies personnel responsible for performing them, and ensures that they are included in annual maintenance budgets ([CCANZ, 2005](#)).



While basic maintenance and/or repair procedures and materials for energy dissipators may be similar to those required in typical maintenance and repair of other structures, the harsh environmental conditions and specific problems associated with working underwater or in the splash zone area of such structures cause many differences, may require specialized products and systems, and may require the services of uniquely qualified and experienced professionals. A survey of maintenance and repair of USACE concrete structures showed that half of all repairs were rated as less than good, with a full 35 percent rated as poor or failed (McDonald and Campbell, 1985, p. 38); this report did not differentiate between repairs to structures subjected to water exposure or not subjected to water exposure, so it is not unreasonable to expect that repairs of hydraulic structures exhibit a higher rate of unsatisfactory repairs.

In spite of the poor historic performance of repairs at hydraulic structures, there have been relatively few comprehensive programs addressing the adequacy of various maintenance and repair techniques and materials. The USACE conducted a multi-year program, from 1984 to 1998, addressing effective and affordable technology for maintaining and extending the service life of existing USACE civil works structures, titled “Repair, Evaluation, Maintenance, and Rehabilitation (REMR) Research Program.” Results of the REMR program are contained in 184 technical reports, 173 technical notes, and 9 video reports. A website (<http://www.wes.army.mil/REMR/remr.html>) provides access to much of the REMR technology (McCleese, 2000).

### 12.1 Diagnosis of cause

The primary construction material used in stilling basins is concrete, so the following sections focus on problems pertinent to concrete. A basic understanding of underlying causes of concrete deficiencies is essential to performing successful repairs in stilling basins. If the cause of a deficiency is understood, it is much more likely that the correct repair method will be selected and that, consequently, the repair will be successful. Symptoms or observations of a deficiency must be differentiated from the actual cause of the deficiency, and it is imperative that causes, rather than symptoms, be addressed in repairs. Only after the cause or causes are known can rational decisions be made concerning the selection of a proper method of repair and in determining how to avoid a repetition of the circumstances that led to the problem.

For example, abrasion erosion may be a result of unsymmetrical gate operation or unusual energy dissipator flow conditions bringing rock back into the basin. Fixing the cause may require additional structures to be added (or removed) or an alteration in operations. Refer to the case histories in the Appendix for [Pomona Dam](#) and [Kinzua Dam](#) for examples of stilling basins that experienced abrasion erosion

damage. Structural repairs were frequently made at these dams until the cause was detected and corrected.

### **12.1.1 Evaluation of the structure**

Proper evaluation of the present condition of the structure is the essential first step for designing any repair or rehabilitation for the structure. If repairs are needed, a comprehensive evaluation of the structure is needed to determine the scope and extent of repairs. To be most effective, an evaluation should include several, if not all, of the following: a review of design and construction documents; a review of operation and maintenance records; a review of instrumentation data; a visual examination of the condition of the concrete in the structure; an evaluation of the structure by nondestructive testing means; a laboratory evaluation of the condition of concrete specimens recovered from the structure; a stress analysis; and a stability analysis of the entire structure.

#### **12.1.1.1 Review of engineering data**



Evaluation of the existing structure requires a thorough review of all pertinent historical information on the structure and its environment, including review of design and construction documents; operation and maintenance records; records of periodic on-site inspections or repairs; and records of instrumentation and monument survey data. Sources of engineering data which can yield useful information of this nature include project design memoranda, plans and specifications, construction history reports, as-built drawings, concrete report or concrete records (including materials used, batch plant and field inspection records, and laboratory test data), instrumentation data, operation and maintenance records, and periodic inspection reports. Instrumentation data and monument survey data to detect movement of the structure should be evaluated.

#### **12.1.1.2 Condition survey**

Once a review of available engineering data is performed, a survey of the structure should be performed to identify and define areas of distress. This survey (termed Condition Survey in [USACE, 1995b](#)) usually includes a mapping of the various types of concrete deficiencies that may be found, such as cracking, surface problems (disintegration and spalling), and joint deterioration. Cracks are usually mapped on fold-out sketches of the monolith surfaces. Mapping must include inspection and delineating of embedded features, and openings. Additionally, a condition survey frequently includes core drilling to obtain specimens for laboratory testing and analysis. American Concrete Institute ([ACI 207.3R](#) and [ACI 364.1R1](#)) provide additional information on procedures for conducting condition surveys. Condition surveys involve several steps:

- *Visual inspection.*—The first step in the on-site evaluation of the structure is a visual inspection of the concrete surfaces. Terms typically used in an inspection are listed in [table 6](#); each term in the table can be found in greater detail in [USACE \(1995b\)](#), [ACI 116R](#), and [ACI 201.1R](#).
- *Crack survey.*—In many cases, cracking is the first symptom of concrete distress. Therefore, a crack survey is significant in evaluating the future serviceability of the structure. A crack survey is an examination of a concrete structure for the purpose of locating, marking, and identifying cracks and determining the relationship of the cracks with other destructive phenomena ([ACI 207.3R](#)). The first step in a crack survey is to locate and mark the cracking and define it by type. The types of cracks are listed in [table 6](#). The width and depth over various portions of the crack should be documented, and it may be necessary to utilize instrumentation to monitor/measure cracks. Monitoring of the crack under various loading conditions is recommended as well.
- *Surface mapping.*—Surface mapping parallels the cracking survey in that deterioration of the surface concrete is located and described. Surface mapping may be accomplished by use of detailed drawings, photographs, or video. Items most often identified and mapped include cracking, spalling, scaling, popouts, honeycombing, exudation, distortion, unusual discoloration, erosion, damage from cavitation, seepage, conditions of joints and joint materials, corrosion of reinforcement (if exposed), and soundness of surface concrete ([USACE, 1995b](#)). A list of items recommended for use in and procedure of a surface mapping may be found in [ACI 207.3R](#) and [USACE \(1995b\)](#).
- *Joint survey.*—A joint survey is a visual inspection of the joints in a structure to determine their condition. All expansion, contraction, control, and construction joints should be located and described and their existing condition noted. Opened or displaced joints should be checked for movement if appropriate, taking into consideration the various loading conditions when measurements of joints are taken. All joints should be checked for defects, and the condition of joint filler, if present, should be examined ([USACE, 1995b](#)).
- *Core drilling.*—Core drilling to recover concrete for laboratory analysis or testing is the best method of obtaining information on the condition of concrete within a structure. Given the expense of core drilling, it is recommended to be considered only when sampling and testing of interior concrete is deemed necessary. If core samples are to be taken, samples should be collected in accordance with American Society for Testing and Materials ([ASTM C 823](#)). More detail on core drilling may be found in [USACE \(1995b\)](#) and [ACI 207.3R](#).

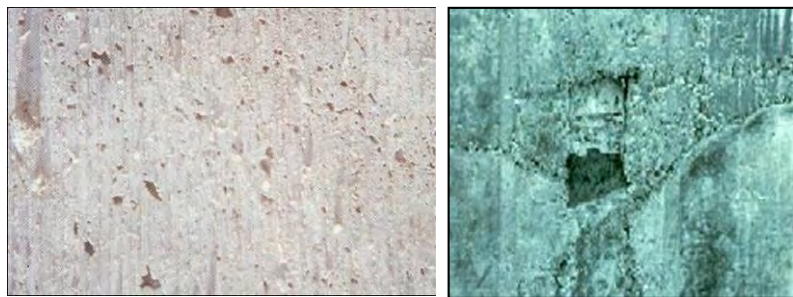
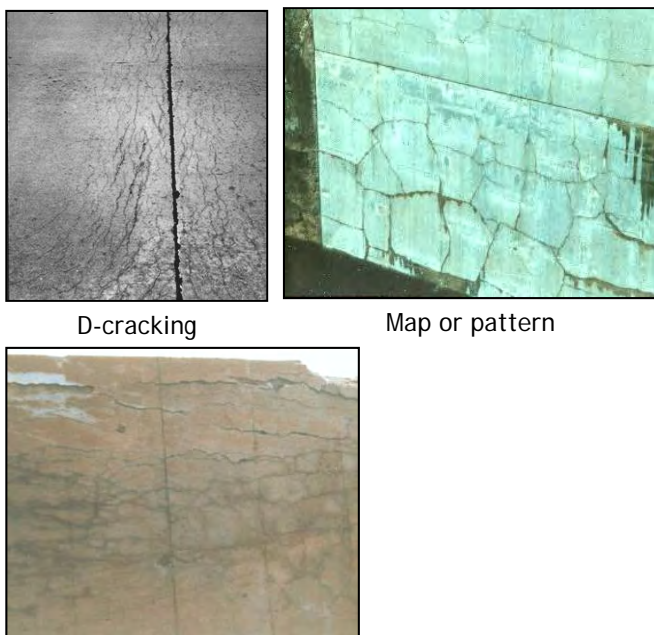
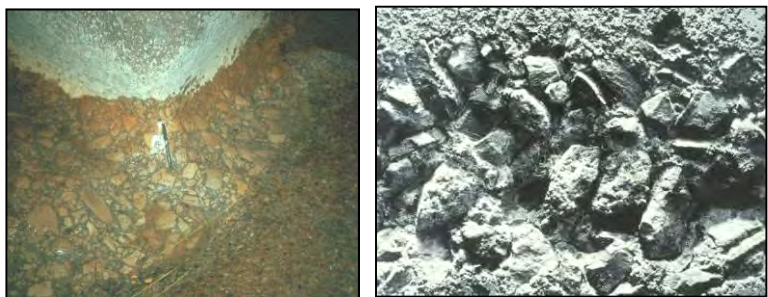
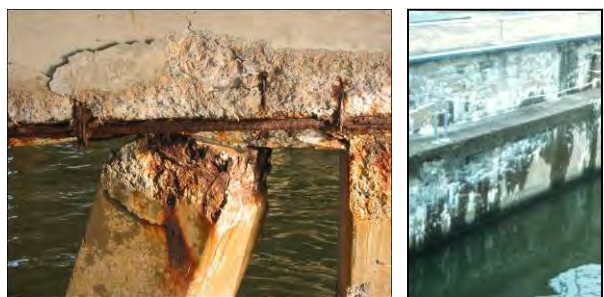

Table 6.—Terms associated with visual inspection of concrete (USACE, 1995b)

Category of defect	Types of defects associated with category	Examples
Construction faults	Bug holes Cold joints Exposed reinforcing steel Honeycombing Irregular surface	 <div style="display: flex; justify-content: space-around; margin-top: 5px;"> <span data-bbox="763 766 868 798">Bug holes</span> <span data-bbox="1128 766 1299 798">Honeycombing</span> </div>
Cracking	Checking or crazing D-cracking Diagonal Hairline Longitudinal Map or pattern Random Transverse Vertical Horizontal Freezing and thawing	 <div style="display: flex; justify-content: space-around; margin-top: 5px;"> <span data-bbox="673 1134 795 1165">D-cracking</span> <span data-bbox="982 1134 1153 1165">Map or pattern</span> </div> <div style="text-align: center; margin-top: 10px;">  <p data-bbox="657 1470 901 1501">Freezing and thawing</p> </div>
Disintegration	Blistering Chalking Delamination Dusting Peeling Scaling Weathering	 <div style="display: flex; justify-content: space-around; margin-top: 5px;"> <span data-bbox="771 1827 860 1858">Dusting</span> <span data-bbox="1209 1827 1299 1858">Scaling</span> </div>



## Outlet Works Energy Dissipators

Table 6.—Terms associated with visual inspection of concrete (continued) (USACE, 1995b)

Category of defect	Types of defects associated with category	Examples
Distortion or movement	Buckling Curling or warping Faulting Settling Tilting	
Erosion	Abrasion Cavitation	
Seepage	Corrosion Discoloration or staining Exudation Efflorescence Incrustation	
Spalling	Popouts Spall	

### 12.1.1.3 Underwater inspection

A variety of procedures and equipment for conducting underwater inspections are available and are discussed in greater detail in [chapter 11](#).

### 12.1.1.4 Laboratory investigations

Once samples of concrete have been obtained, whether by coring or other means, they should be examined in a qualified laboratory. In general, the examination should include petrographic, chemical, or physical tests. Petrographic examination of hardened concrete should be performed in accordance with [ASTM C 856](#) by a person qualified by education and experience so that proper interpretation of test results can be made. Testing core samples for compressive strength and tensile strength should follow the method specified in [ASTM C 42](#).

### 12.1.1.5 Nondestructive testing

The purpose of nondestructive testing (NDT) is to determine the various relative properties of concrete such as strength, modulus of elasticity, homogeneity, integrity, and internal cracking and voids, without damaging the structure. Selection of the most applicable method or methods of testing requires good judgment based on the information needed, size and nature of the project, site conditions, and risk to the structure (ACI 207.3R). Information on NDT techniques can be found in [Malhotra \(1976\)](#), [Thornton and Alexander \(1987\)](#), [Carino \(1992\)](#), and [Alexander \(1993\)](#), with recent advances in nondestructive testing of concrete summarized by [Malhotra and Carino \(2003\)](#).

### 12.1.1.6 Additional investigations





[USACE \(1995b\)](#) describes several additional investigations which may be pursued, including stability analysis, deformation monitoring, concrete service life (freeze-thaw and other deterioration mechanisms), and a reliability analysis. [USACE \(1995b\)](#) provides information on where guidance for each of these investigations may be found.

## 12.1.2 Causes of distress and deterioration

Once the evaluation phase has been completed for a structure, the next step is to establish the cause or causes for the damage that has been detected. The common causes of problems in concrete are shown in [table 7](#). In most cases, the damage detected is the result of more than one mechanism ([USACE, 1995b](#)).

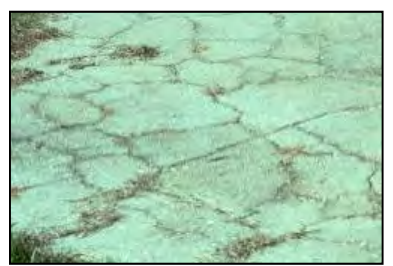

Table 7.—Common causes of distress and deterioration in concrete (USACE, 1995b)

Cause of distress/deterioration	Examples of cause		
Accidental loadings			
Chemical reactions (Examples shown below)	Acid attack Aggressive-water attack Alkali-carbonate rock reaction Alkali-silica reaction Miscellaneous chemical attack Sulfate attack		
			
Acidic water attack	Aggressive water attack	Pattern cracking from alkali-silica reaction	Sulfate attack
Construction errors			
Corrosion of embedded metals			
Design errors		Inadequate structural design Poor design details	
Erosion		Abrasion Cavitation	
Freezing and thawing			
Settlement and movement			
Shrinkage			
Temperature changes		Internally generated Externally generated Fire	
Weathering			

### 12.1.2.1 Accidental loadings

Accidental loadings may be characterized as short-duration, one-time events such as the impact of a large object against a wall or a seismic event. These loadings can generate stresses higher than the strength of the concrete, which may result in localized or general failure. Determination of whether an accidental loading caused damage to the concrete requires knowledge of the events preceding discovery of the damage. Visual examination usually shows spalling or cracking of concrete that has been subjected to accidental loadings. Although, by their very nature, accidental loadings cannot be avoided, their impact to structural integrity can be minimized by adhering to proper design criteria and procedures.

Figure 169 shows a baffle block that has experienced damage resulting from impact.

### 12.1.2.2 Chemical reactions

Deleterious chemical reactions may be classified as those that occur as the result of external chemicals attacking the concrete (acid attack, aggressive water attack, miscellaneous chemical attack, and sulfate attack) or those that occur as a result of internal chemical reactions between the constituents of the concrete (alkali-silica and alkali-carbonate rock reactions). The visual aspects of each chemical reaction are described in this section. For further details, refer to [USACE \(1995c\)](#). Descriptions of these chemical reactions include:

- *Acid attack.*—Visual examination shows disintegration of the concrete evidenced by loss of cement paste and aggregate. If the acid has reached reinforcing, rust staining, cracking, and spalling may be present.
- *Aggressive water attack.*—Visual examination shows concrete surfaces that are very rough in areas where the paste has been leached. Sand grains may be present on the surface of the concrete, making it resemble coarse sandpaper. If the aggregate is susceptible to leaching, holes where the coarse aggregate has been dissolved will be evident.
- *Alkali carbonate rock reaction.*—Visual examination of those reactions that are serious enough to disrupt the concrete in a structure generally shows map or pattern cracking and a general appearance that indicates that the concrete is swelling. A distinguishing feature that differentiates alkali-carbonate rock reaction from alkali-silica reaction is the lack of silica gel exudations at cracks. Petrographic examination in accordance with [ASTM C 295](#) may be used to confirm the presence of alkali-carbonate rock reaction.



**Figure 169.**—This baffle block has experienced impact damage resulting from an object in the flow.

- *Alkali silica reaction.*—Visual examination of those concrete structures that are affected generally shows map or pattern cracking and a general appearance that indicates that the concrete is swelling. Petrographic examination may be used to confirm the presence of alkali-silica reaction.
- *Sulfate attack.*—Visual examination shows map and pattern cracking as well as a general disintegration of the concrete. Laboratory analysis can verify the occurrence of the reactions described.
- *Miscellaneous chemical attack.*—Concrete resists chemical attack to varying degrees, depending upon the exact nature of the chemical. [ACI 515.1R](#) includes an extensive listing of the resistance of concrete to various chemicals.

Visual examination of concrete that has been subjected to chemical attack usually shows surface disintegration and spalling ([figure 170](#)) and the opening of joints and cracks. There may also be swelling and general disruption of the concrete mass. Coarse aggregate particles are generally more inert than the cement paste matrix; therefore, aggregate particles may be seen as protruding from the matrix. Laboratory analysis may be required to identify the unknown chemicals that are causing the damage.



**Figure 170.**—Chemical attack is often characterized by surface disintegration and spalling.

#### **12.1.2.3 Construction errors**

Failure to follow specified procedures and good practice may lead to a number of conditions that may be grouped together as construction errors. Typically, most of these errors do not lead directly to failure or deterioration of concrete. Instead, they enhance the adverse impacts of other mechanisms identified in this chapter. Common construction errors include, adding water to concrete, improper alignment of formwork, improper consolidation of concrete, improper curing, improper location of reinforcing steel, movement of formwork, premature removal of shores or reshores, settling of the concrete, vibration of freshly placed concrete, and improper finishing of flatwork. In general, the best preventive measure is a thorough knowledge of what these construction errors are plus an aggressive inspection program. Errors of this type are equally as likely to occur during repair or rehabilitation projects as they are likely to occur during new construction. For further details, a brief description of each is given in [USACE \(1995c\)](#).

#### **12.1.2.4 Corrosion of embedded materials**

Corrosion of the reinforcing steel is among the most frequent causes of damage to concrete. Corrosion is generally detected by rust staining of the concrete followed by parallel lines of cracking in uniform intervals and spalling of the concrete. For causes and effects of reinforcing steel corrosion, refer to [USACE \(1995c\)](#).



### 12.1.2.5 Design errors

Design errors may be divided into two general types: those resulting from inadequate structural design and those resulting from lack of attention to relatively minor design details (USACE, 1995c).

### 12.1.2.6 Erosion

Two kinds of erosion can damage energy dissipators:

- *Abrasion erosion.*—Causes of abrasion erosion damage and the procedures for repair and prevention of damage are described in ACI 210R (1993). The action of debris rolling and grinding against a concrete surface causes abrasion erosion damage. The sources of the debris include construction trash left in a structure, rock, sand, and gravel brought back into a basin by eddy currents that are produced inherently during operation of a hydraulic jump basin, or asymmetrical discharge, and rock, sand, and gravel or other debris thrown into a basin by vandals. Concrete surfaces abraded by waterborne debris are generally smooth and may contain localized depressions (see the example in table 6). Most of the debris remaining in the structure will be spherical and smooth. Mechanical abrasion is usually characterized by long shallow grooves in the concrete surface and spalling along monolith joints. Armor plating is often torn away or bent.

Unfortunately, all of the construction materials currently being used in hydraulic structures are to some degree susceptible to erosion, given the right flow conditions with debris present. Fortunately, eliminating or reducing the source of debris can be accomplished in most cases. Prior to construction or repair of major structures, hydraulic model studies of the structure may be required to identify potential causes of erosion damage and to evaluate the effectiveness of various modifications in eliminating those undesirable hydraulic conditions (see the [Mason Dam case history](#) in the appendix). Operational considerations should also be taken into account, such that releases of water are balanced across all gates, to avoid the induction of eddies that may bring debris back into the basin. Substantial discharges should be released into a basin to flush debris from it. If possible, other means of cleaning are recommended if flushing cannot clear debris from the basin. Periodic inspections should evaluate the presence of debris in the basin and the extent of any erosion. Refer to [chapter 11](#) for additional information on inspection and basin cleaning.

The location of extensive abrasion erosion damage can occur at different locations within the structure depending on the quantity of discharge. For example, at low discharges in a stilling basin, damage may be found at the upstream end on the chute floor. At slightly higher discharges, damage may be found near the toe of the chute (both on the chute and stilling basin floor). At progressively higher flows, extensive damage from abrasion may be found further

downstream in the stilling basin. The velocity of flow plays an important part in the potential for abrasion. Rocks entrained in high velocity flow can cause a higher degree of damage than rocks being moved by slower flow.

The case histories in the appendix for [Arkabutla, Enid, Pomme de Terre, and Pomona Dams](#) illustrate the problems abrasion erosion can create.

- *Cavitation erosion.*—Cavitation erosion is the result of flow irregularities over surfaces such as concrete or steel subjected to high velocity flow. Cavitation is a serious problem because the forced upon the concrete when the cavitation bubbles implode can be large enough to damage the surface. Left unchecked, cavitation may remove large quantities of material such that the very integrity of the structure itself will be threatened.

Generally, cavitation cannot occur unless flow velocities exceed 40 feet per second and surface irregularities are present. Cavitation has severely damaged the outlet works of many high dams. Concrete that has been damaged is severely pitted and extremely rough (see example in [table 6](#)). As the damage progresses, the roughness of the damaged area may induce additional cavitation. The best means by which to avoid damage from cavitation are to follow proper hydraulic design criteria, such as found in [Reclamation's \*Cavitation in Chutes and Spillways\*, 1990b](#). Although reducing or eliminating the causes of cavitation are the only totally effective solution to cavitation problems, it is recognized that in repairing a structure, reducing or eliminating the source of cavitation may not be possible. In such a case, the design should be changed or the flow aerated. Replacing cavitation-damaged concrete with more cavitation-resistant materials is only effective for a very short period.

The following parameters provide guidance for the recognition of cavitation damage ([Reclamation, 1990b, pp. 39-41](#)):

1. *Texture.*—Collapsing cavities are primarily caused by a pressure wave that travels at the speed of sound in the water. Since the speed of sound is between 10 and 40 times greater than the flow velocities, which are normally associated with damage, damage appears to be caused by a source perpendicular to the surface. This means the direction of flow cannot be determined by examining the damaged area. In addition, this effect has an impact on the texture of the damage.

On steel, the collapse of the many minute cavitation bubbles perpendicular to the surface produces a grainy texture. The scale of surface texture depends upon the size of the cavitation bubbles that are produced.



The collapse perpendicular to a concrete surface cleans individual pieces of aggregate of the cement that binds the concrete. Deep crevices and holes can be found in the matrix giving an appearance as though worms have bored into the concrete. None of the aggregate is broken.

The contrast between the texture of damage caused by cavitation and that caused by erosion with sand-laden water is easily recognized for steel. With cavitation, direction cannot be detected, and the surface has a grainy texture. With erosion by sand-laden water, flow direction is apparent, and the surface is smooth and shiny.

Similarly, the difference between cavitation damage, freeze-thaw damage, and erosion by sand-laden water is apparent for concrete. With cavitation, individual, polished pieces of aggregate are exposed in the damaged zone.

In a freeze-thaw zone, individual pieces of aggregate are broken, and the profile through the damaged area is relatively flat. With erosion by sand-laden water, individual pieces of aggregate are polished, as with cavitation, but the underlying surface is smooth and relatively even.

2. *Symmetry*.—If cavitation damage occurs on a structure, it occurs in similar locations elsewhere on the structure. For instance, if cavitation damage is observed on the conduit wall downstream of a gate slot, it will occur downstream of the opposite gate slot.
3. *Origin*.—Cavitation damage always occurs downstream from its source. This has two important implications. First, there must be a source of the cavitation, and secondly, the damage will not progress upstream of the source. Usually, the source is easily identified. Surface irregularities, calcite deposits, gate slots, and sudden changes in flow alignment are typical sources for damage.

Longitudinal vortices in the flow are known also to be sources of cavitation damage. Generally, the exact location of these sources cannot be accurately specified.

### 12.1.2.7 Freezing and thawing

Freezing and thawing may result in symptoms ranging from surface scaling to extensive disintegration. Laboratory examination of cores taken from structures that show surficial effects of freezing and thawing often shows a series of cracks parallel to the surface of the structure (USACE, 1995b). This is also referred to as delamination. ACI 201.2R contains recommended preventive measures for saturated concrete exposed to freeze-thaw action. Concrete is especially vulnerable in areas of fluctuating water levels or under spraying conditions (USACE, 1995b).

#### 12.1.2.8 Settlement and movement

Visual examination of structures undergoing settlement or movement usually reveals cracking, spalling, or faulty alignment of structural members. An increase of water leaking into the structure is another good indication of structural movement. A review of instrumentation data is helpful in determining whether apparent movement is real since differential settlement of the foundation of a structure is usually a long-term phenomenon. A review by structural and geotechnical engineering specialists is required (USACE, 1995b).

#### 12.1.2.9 Shrinkage

There are several causes of shrinkage. Shrinkage from the loss of moisture from concrete is typically the most prevalent cause. Shrinkage from moisture loss may be divided into two general categories: that which occurs before setting (plastic shrinkage) and that which occurs after setting (drying shrinkage) (USACE, 1995b).

#### 12.1.2.10 Temperature changes

Changes in temperature cause a corresponding change in the volume of concrete. However, temperature-induced volume changes must be combined with restraint before damage can occur. Three temperature change phenomena may damage concrete: (1) temperature changes that are generated internally by the heat of hydration of cement in large placements; (2) temperature changes generated by variations in climatic conditions; and (3) the special case of externally generated temperature change, fire damage.

#### 12.1.2.11 Weathering

Weathering is frequently referred to as a cause of concrete deterioration. ACI 116R defines weathering as “Changes in color, texture, strength, chemical composition, or other properties of a natural or artificial material due to the action of the weather.” Since all of these effects may be more correctly attributed to other causes of concrete deterioration described in previous sections, weathering itself is not considered a specific cause of deterioration (USACE, 1995b).

### 12.1.3 Relating symptoms to causes of distress/deterioration

Since many of the causes of concrete deterioration cause the same symptoms, it is more difficult than it may first appear to relate symptoms to causes. The procedure set forth by Johnson (1965) is recommended in USACE (1995b) as a starting point in analysis:

1. *Evaluate structure design to determine adequacy.*—First consider what types of stress could have caused the observed symptoms. Secondly, attempt to relate the

## Outlet Works Energy Dissipators

probable types of stress causing the damage noted to the locations of the damage. Next, if the damage seems appropriate for the location, attempt to relate the specific orientation of the damage to the stress pattern. If no inconsistency is encountered during this evaluation, then overstress may be the cause of the observed damage. A thorough stress analysis is warranted to confirm this finding.

2. *Relate the symptoms to potential causes.*—If an inconsistency has been detected in the previous step, such as cracking in a compression zone, this step in the procedure should be followed. For this step, table 8 should be used. Depending upon the symptom, it may be possible to eliminate several possible causes.

**Table 8.**—Relating symptoms to causes of distress and deterioration of concrete (USACE, 1995b)

Causes	Symptom						
	Cracking	Disintegration	Distortion/movement	Erosion	Joint failures	Seepage	Spalling
Accidental loadings	X						X
Chemical reactions	X	X				X	
Construction errors	X				X	X	X
Corrosion	X						X
Design errors	X				X	X	X
Erosion		X		X			
Freezing and thawing	X	X					X
Settlement and movement	X		X		X		X
Shrinkage	X		X				
Temperature changes	X				X		X

3. *Eliminate the readily identifiable causes.*—From the list of possible causes remaining after symptoms have been related to potential causes, it may be possible to eliminate two causes very quickly since they are relatively easy to identify.

4. *Analyze the available clues.*—If no solution has been reached at this stage, all of the evidences generated by field and laboratory investigations should be carefully reviewed.
5. *Determine why the deterioration has occurred.*—Once the basic cause or causes of the damage have been established, there remains one final requirement: to understand how the causal agent acted upon the concrete. Only when the cause and its mode of action are completely understood should the next step of selecting a repair material and method be attempted (USACE, 1995b).

## 12.2 Methods of Repair

In order to achieve a long-lasting, effective repair, it is necessary to consider the design and selection of repair systems as parts of a composite system. The repair material is only one consideration; equally important are surface preparation, method of application, method of construction and inspection. Figures 171 and 172 show concrete surfaces undergoing various preparations. *Reclamation's Guide to Concrete Repair* (1997) provides a good source for methods and material selection for use in repairing concrete.

### 12.2.1 Design of concrete repairs

The repair material and method should be compatible with the existing concrete substrate. The repair system should withstand all anticipated stresses over the design life with no distress or deterioration. For detailed discussion of compatibility issues, refer to *Emmons, Vaysburd, and McDonald* (1993 and 1994) and *McDonald, Vaysburd, and Poston* (2000).

#### 12.2.1.1 Properties of repair materials

In addition to conventional Portland cement concrete and mortar, there are hundreds of proprietary repair materials on the market, and new materials are continually being introduced. This wide variety of both specialty and conventional repair materials provides a greater opportunity to match material properties with specific project requirements; however, it can also increase the chances of selecting an inappropriate material. No matter how carefully a repair is made, use of the wrong material will likely lead to early repair failure. Before selecting a repair material, take into account the material's compressive strength, modulus of elasticity, coefficient of thermal expansion, adhesion/bond, drying shrinkage, creep and permeability. These properties should be considered before any material is selected for use on a repair or rehabilitation project. For further details on these properties, refer to *USACE* (1995c).



Figure 171.—Sawcutting the perimeter of spalled concrete prior to removal of concrete.



Figure 172.—Blowing compressed air over the surface of the concrete to remove excess moisture.



### 12.2.1.2 Application and service conditions

The conditions under which the repair material is placed and the anticipated service or exposure conditions can have a major impact on design of a repair and selection of the repair material. The following factors should be considered in planning a repair strategy.

Application conditions:

- *Geometry.*—The depth and orientation of a repair section can influence selection of the repair material. In thick sections, heat generated during curing of some repair materials can result in unacceptable thermal stresses. In addition, some materials shrink excessively when placed in thick layers. Some materials, particularly cementitious materials, spall if placed in very thin layers. In contrast, some polymer-based materials can be placed in very thin sections. The maximum size of aggregate that can be used is dictated by the minimum thickness of the repair. The repair material must be capable of adhering to the substrate without sagging when placed on vertical or overhead surfaces without forming.
- *Temperature.*—Portland cement hydration ceases at or near freezing temperatures, and latex emulsions do not coalesce to form films at temperature below about 45 °F. Other materials may be used at temperatures well below freezing, although setting times may be increased. High temperatures make many repair materials set faster, decrease their working life, or preclude their use entirely.
- *Moisture.*—A condition particular to hydraulic structures is the presence of moisture or flowing water in the repair area. Generally, flowing water must be stopped by grouting, external waterproofing techniques, diverting water, or with drainage systems. Some epoxy and polymer materials do not cure properly in the presence of moisture while others are moisture insensitive.
- *Location.*—Limited access to the repair site may restrict the type of equipment, and thus the type of material that can be used for repair. In addition, components of some repair materials are odorous, toxic, or combustible. Obviously, such materials should not be used in poorly ventilated areas or in areas where flammable materials are not permitted.

Service conditions:

- *Down time.*—Materials with rapid strength gain characteristics that can be easily placed with minimal waste should be used when the repaired structure must be returned to service in a short period. Several types of rapid-hardening cements and patching materials are described in [REMR Technical Note CS-MR-7.3](#).



- *Traffic*.—If the repair will be subject to heavy vehicular traffic, a high strength material with good abrasion and skid resistance is necessary.
- *Temperature*.—A material with a coefficient of thermal expansion similar to that of the concrete substrate should be used for repairs subject to wide fluctuations in temperature. High service temperatures may adversely affect the performance of some polymer materials. Resistance to cycles of freezing and thawing is important in many applications.
- *Chemical attack*.—Acids and sulfates cause deterioration in cement-based materials while polymers are resistant to such chemical attack. However, strong solvents may attack some polymers. Soft water is corrosive to Portland cement materials.
- *Appearance*.—If it is necessary to match the color and texture of the original concrete, many, if not most, of the available repair materials will be unsuitable. Portland cement mixtures with materials and proportions similar to those used in the original construction are necessary where appearance is a major consideration.
- *Service life*.—The function and remaining service life of the structure requiring repair should be considered in selection of a repair material. An extended service life requirement may dictate the choice of repair material regardless of cost. On the other hand, perhaps a lower cost, less durable, or more easily applied material can be used if the repair is only temporary.

### 12.2.1.3 Material selection

Most repair projects have unique conditions and special requirements that must be thoroughly examined before the final repair material criteria can be established. Once the criteria for a dimensionally compatible repair have been established, materials with the properties necessary to meet these criteria should be identified. A variety of repair materials has been formulated to provide a wide range of properties. Since these properties affect the performance of a repair, selecting the correct material for a specific application requires careful study.

### 12.2.1.4 Repairs material database

The USACE Repair Material Database was developed to provide technology transfer of results from evaluations of commercial repair products performed under the REMR Research Program.

#### 12.2.1.5 General categorization of repair approach

For ease of selecting repair methods and materials, it is helpful to divide the possible approaches into two general categories: those more suited for cracking or those more suited for spalling and disintegration. For information on selecting materials and methods for repair, refer to [USACE \(1995c\)](#) or [Reclamation \(1997\)](#).

#### 12.2.2 Concrete removal and preparation for repair

Most repair projects involve removal of distressed or deteriorated concrete. For techniques involving removal of concrete, preparation of concrete surfaces for further work such as overlays, preparation and replacement of reinforcing steel that has been exposed during concrete removal, and anchorage systems refer to [USACE \(1995c\)](#) or [Reclamation \(1997\)](#).

#### 12.2.3 Materials and methods

For descriptions of various materials and methods that are available for repair or rehabilitation of concrete structures, refer to [USACE \(1995c\)](#) or [Reclamation \(1997\)](#). Materials and methods described in these references include description, applications and limitations, and procedure.

#### 12.2.4 Underwater repairs

Because of the difficult working conditions and the difficulty of providing adequate inspection during construction, underwater placement of concrete and other materials is often susceptible to errors and poor construction practices. For information on surface preparation, anchors, materials, inspection, and support personnel/equipment refer to [USACE \(1995c\)](#) or [Reclamation \(1997\)](#).

### 12.3 Maintenance of Concrete

Most, if not all, regulatory agencies with authority to oversee dam safety programs establish minimum general maintenance requirements for all dams under their purview (as examples, see [NYSOLD, 2000](#) and [NCDENR, 2007](#)). Likewise, governmental agencies that operate large dams typically spell out general maintenance requirements in appropriate governing documents such as [USACE's Flood Control Operations and Maintenance Policies \(1996\)](#). However, these guidelines are nearly always quite general and nonspecific. Dam operators should maintain an Operations and Maintenance Manual for each dam project operated, with specific maintenance needs outlined in as much detail as possible. Proper maintenance of concrete to prevent deterioration is far more economical than repairing concrete. The primary types of maintenance for concrete include timely repair of cracks and

spalls, cleaning of concrete to remove unsightly material, surface protection, and joint restoration.

### 12.3.1 Surface coatings and sealing compounds

Surface coatings and sealing compounds are applied to concrete for protection against chemical attack of surfaces by acids, alkalis, salt solutions, or a wide variety of organic chemicals. For further guidance on procedures for surface preparation, coatings, and sealers refer to [USACE \(1995c\)](#) or [Reclamation \(1997\)](#).

### 12.3.2 Joint maintenance

Little maintenance is required for buried sealants such as waterstops because they are not exposed to weathering and other deteriorating influences. Most field-molded sealants do, however, require periodic maintenance if an effective seal is to be maintained and deterioration of the structure is to be avoided. The necessity for joint maintenance is determined by service conditions and by the type of material used.

Minor touchups of small gaps and soft or hard spots in field-molded sealants can usually be made with the same sealant. However, where the failure is extensive, it is usually necessary to remove the sealant and replace it. A sealant that has generally failed but has not come out of the sealing groove should be removed by hand tools or, on large projects, by routing or plowing with suitable tools. To improve the shape factor, the sealant reservoir may be enlarged by sawing. After proper preparation has been made to ensure clean joint faces and additional measures designed to improve sealant performance, such as improvement of shape factor, provision of backup material, and possible selection of a better type of sealant, have been accomplished, the joint may be resealed. For additional information on joint sealant materials, joint design, and installation of sealants, see [USACE's EM 1110-2-2102 \(1995d\)](#) and [ACI 504R](#).

## Chapter 13

# Public Safety and Vandalism Protection

Accident reports indicate many mishaps at dams have occurred downstream from gated structures. Several areas around a dam are dangerous for swimming. These include outflows, intakes, spillways, and energy dissipators. Given the opportunity, there are people who would eagerly dive into an energy dissipator. This may seem relatively harmless on a warm summer day when the outflows through the basin do not appear dangerous. However, because of the way energy dissipators are constructed, egress can be difficult.

People who choose to swim too close to dam facilities are taking a great risk with their own lives (figure 173). Turbulent currents that cannot be readily discerned at the water's surface can drag the swimmer underwater. Roller currents in energy dissipators that can carry rocks and debris back into the basin can also severely injure or kill. In addition, roller currents can keep swimmers submerged, causing death by drowning (Pugh and Klumpp, 1988).

Even in an energy dissipator with little flow and no dangerous currents, a swimmer who is unable to touch the bottom and unable to extricate themselves from the dissipator can become exhausted and unable to stay afloat. Although entry may have been unlawful and unwise, if no means are provided for potential swimmers to exit the energy dissipator, their lives may be endangered.

Energy dissipators can also present significant dangers to boaters. Boats operating too close to the structure may become entrapped by currents around the structure, pulling the boat into turbulent waters. Enhancing public safety around energy dissipators can be summarized in three categories: discouraging access, preventing access, and providing for rescue.

### 13.1 Discouraging Access

Efforts to educate the public about the dangers existing near energy dissipators can be an effective tool in preventing accidents. Dam owners, particularly those owned by public agencies, are typically aware of the dangers existing near their dams, and



Figure 173.—Person taking great risk near an intake structure.

often have an opportunity to disseminate this information to the public. Outreach efforts can be made through brochures, posters, videotapes, websites, television and radio announcements, and newspapers. As part of a public relations program, an owner can directly interact with the public at schools, civic organizations, etc. Information concerning the normal operations of the appurtenant structures of the dam affecting public safety should be made available by the owner. The public should also be alerted to special operating circumstances creating safety issues differing from those arising from normal operation of the structure. The Coast Guard, state natural resource agencies, schools, private boating and swimming clubs, and water safety organizations such as the National Water Safety Congress, may have existing safety programs and information available.

### 13.1.1 Signs and buoys

Properly designed, located, and maintained signs ([figure 174](#)) and buoys can be an effective means of limiting entrance of the public into hazardous areas. These devices are typically required in areas where it is necessary to warn the public of dangerous conditions. Multiple layers of signs and buoys, as one approaches the dangerous condition, may be desirable. A person may already be in danger by the time he or she is able to view a single warning given at the site of the dangerous condition. In at least two instances, warning sign requirements have been incorporated into state dam safety law ([State of Wisconsin, 2005](#); [State of Pennsylvania, 1998](#)).



Figure 174.—Warning sign.

Signs should be used to direct, identify, inform, or warn the public and should:

- Be located to gain visitors' attention.
- Convey the nature of the hazard posed by specific conduct.
- Warn of the hazard with intensity commensurate with the potential outcome.
- Explain how to act to avoid injury.
- Explain consequences of failing to obey.

The Federal Energy Regulatory Commission's (FERC) [“Safety Signage at Hydropower Projects”](#) (2001) provides dam owners with easy-to-access information and examples of safety signage suitable for use at their facilities. This manual presents relevant and generally available information, and directs interested individuals to more detailed references and resources. The manual contains:

- An overview of safety signage concepts and current standards.
- Examples of possible dangers associated with projects that require signage.
- Annotated signage examples.
- A safety bibliography.
- An internet resource list with links to safety web sites.
- Supporting safety documents.



Lettering on signs should be large enough to be read from a distance, even by those with less than perfect eyesight. A general rule, given in many references, is that a sign should be legible, and easily noticed, from a distance of 300 feet (FERC, 1992). In addition to “No Trespassing” and “Keep Out” messages, signs can also advise the reader of the real danger associated with the intended message, such as “Danger—Dam Ahead,” “Danger of Drowning,” “Stay Alive by Staying Out,” or “Entering Will Result in Certain Death.” Effective signs not only warn the reader, but also tell them what they should do.

Signs should be maintained in a readable condition and regularly inspected to ensure problems with the signs are corrected. Faded lettering should be replaced. Trees, brush, and other vegetation obstructing the view of the sign should be removed, as well as any accumulation of debris. In addition to a regular inspection program, signs should be inspected after significant flooding or severe weather events.

Buoys essentially serve as floating signs. Buoys are used to delineate navigation routes, identify danger zones, mark hazardous submerged objects, regulate boat velocity, and provide other information to boaters and swimmers. Buoys should be installed in conformance with accepted rules and regulations as required in the state where the project is located.

### **13.1.2 Audible devices**

Audible devices are typically used to provide warnings to those in the immediate vicinity of a structure of an upcoming change in operation of a structure, or of an anticipated increase in hazard. The devices may consist of sirens, horns, buzzers, or loudspeakers. Care should be taken with the use of audible devices so that they are not mistaken for devices used for emergency vehicles. In addition, the sounding of audible devices should precede the hazardous event by a sufficient amount of time for those within the warning limits to exit the area. Signs describing the meaning of the audible devices should be utilized along access points to the areas. The language used in the audible warning should take into consideration the general population(s) near the dam.

### **13.1.3 Lights**

Lights are usually utilized as a component of discouraging access to energy dissipators, along with other measures. Lighting provides a complement to signs and buoys, particularly in areas with heavy night usage. Strobe lighting or beacons may also be employed with audible devices for additional effect. Hazardous areas may also be lit to prevent accidental night access.

### 13.1.4 Camouflage

Another approach to inhibit access to energy dissipators is to hide the structure with vegetation. This approach would serve to reduce the temptation for a would-be trespasser to enter the structure. Hiding the structure, as the sole means of inhibiting access, however, would not typically be appropriate. Screening the structure from view, perhaps from a public roadway, may be useful as a component of more comprehensive safety measures. Typical maintenance standards for controlling vegetation near appurtenant structures around dams would make use of this approach difficult in areas immediately adjacent to stilling basins.

## 13.2 Preventing Access

### 13.2.1 Land-based access barriers

A physical barrier is commonly provided to prevent access to energy dissipators. These barriers are most commonly constructed of fencing material (figure 175). Fences, along with signs and locked gates, typically provide the most effective means of prohibiting access to energy dissipators. The required fence height, as well as the need for supplementary measures such as barbed wire along the top of the fence, need to be carefully considered by the designer based on site-specific project requirements.

Another means of providing a physical barrier includes the use of guardrail, in the case of vehicular traffic. The barrier may also be constructed by extending the walls of the structure vertically, above the surrounding grade, or by strategically placing appurtenant buildings for the dam between the public and the hazardous situation. Natural features, such as high cliff walls, may also provide effective access control (figure 176).

### 13.2.2 Boat barriers

Positive restraining barriers may be placed across the channel downstream of energy dissipators to prevent boaters from entering unsafe areas. These barriers may be either floating or permanently affixed to the channel bottom. Floating barriers may be preferable for most applications, as these barriers can be removed seasonally to prevent ice damage. Floating barriers also tend to accumulate less debris.

Barriers should be painted with bright colors, and include signs and/or standard U.S. Coast Guard Inland Waterway markings to educate the boater of the danger lying beyond the barrier. Well lit barriers should be considered in applications where boating at night is anticipated.



Figure 175.—Fencing installed along the tops of the stilling basin walls.



Figure 176.—Fencing at a stilling basin. The steep cliffs also provide an access deterrent.

### 13.2.3 Vegetation

Thorny vegetation can be an effective secondary measure to prevent land-based access to energy dissipators. Well placed vegetation can be particularly helpful, when placed adjacent to fencing, in discouraging climbers. Vegetation can also be placed along the edge of the downstream channel near the energy dissipator to discourage the entry of trespassers into the water and swimming into the energy dissipator.

Typical maintenance standards for controlling vegetation near appurtenant structures around dams would make use of this approach difficult in areas immediately adjacent to energy dissipators.

### **13.2.4 Marshes**

Shallow, flooded areas downstream of energy dissipation structures have been used successfully to prevent pedestrian access to energy dissipators ([State of Wisconsin Department of Natural Resources \(2006\)](#)). The use of marshes to control access to energy dissipators is heavily dependant on site topography and flow characteristics adjacent to the structure.

### **13.2.5 Guards**

Uniformed guards and watchmen can be employed in areas with heavy public use to restrict access to dangerous areas and enforce regulations governing use of the project site.

## **13.3 Extraction and Self-Rescue**

### **13.3.1 Slope changes**

In energy dissipation structures too deep for a trapped swimmer to stand, gently sloping sides can allow the trapped swimmer to exit the pool. In a structure with otherwise vertical sidewalls above the pool, a section of the structure could be constructed with a gentle slope to allow for self-rescue.

### **13.3.2 Benches**

A bench can be constructed into the side of the structure, at a depth of about 18 inches below the normal water surface, such that a trapped swimmer could rest on the bench until rescued.

### **13.3.3 Handholds and ladders**

Handholds or ladders can be placed in the sides of the structure where trapped swimmers could hold themselves above the water surface until rescued. These items could also be utilized to allow trapped swimmers to extricate themselves from the energy dissipation structure. These devices, however, could be attractive nuisances, and create a point of entry for the determined trespasser to enter the basin. The use of handholds/ladders should be carefully considered and not employed where their use may create a more dangerous condition.

### 13.3.4 Cables and nets

Safety cables, booms, or nets may be placed across a normally inundated structure to rescue trapped swimmers that may be caught in a flow of water. Ladders may be employed adjacent to the anchorages for these devices, to allow the swimmer to escape. Care should be taken with the use of suspended cables, as these devices may not be readily visible, and could create a hazard for boaters in the area.

### 13.3.5 Life preservers

Life preservers and life rings may be suitable for use adjacent to structures where aid is likely to be available for a trapped swimmer. These devices should be placed in readily accessible locations and well identified. At remote or unmanned facilities, or at facilities subject to frequent vandalism, the installation of these devices may not be practical.

## 13.4 Vandalism Protection

Vandals sometimes throw objects into energy dissipation structures. These objects can cause problems with abrasion erosion during operation. A variety of ways exists for dam operators and other personnel to deal with this and other types of vandalism at dam facilities. These include vertical and horizontal barriers, grouting the source rock, and eliminating the rock.

Signage, as a means to discourage rock throwing, is not generally effective and may very well increase the likelihood of vandalism occurring.

### 13.4.1 Consequences of rock throwing

Allowing quantities of rock to be thrown into energy dissipators can cause different degrees of damage. The primary damaging mechanism with rocks thrown by vandals is ball milling. The degree of damage to the energy dissipator is dependent on several factors, including the duration and volume of flows through the energy dissipator, flow characteristics, size of rocks and objects trapped in the energy dissipator, etc. Damage can range from minor ([figure 177](#)) to severe ([figure 178](#)), depending on the combination of these factors present within a particular energy dissipator. However, most of this type of damage to energy dissipators would be classified as an operation and maintenance concern, and not dam safety, except for some rare instances.





Figure 177.—Minor abrasion erosion damage.



Figure 178.—Severe abrasion erosion damage.

In order to create a large amount of damage to an energy dissipator, significant quantities of rock would have to enter the energy dissipator, by the action of vandals, rock slides, or hydraulic action downstream. Smaller quantities of large rocks and other objects can, however, chip the concrete and create a weak point where flows could further degrade the concrete surface. Additionally, it would seem logical that relatively small rocks would not be as much of a concern as larger rocks. However, there have been cases when very small rocks have caused significant damage. One example is the [Virginia Smith Dam](#) in the appendix. Virginia Smith Dam had been in operation for approximately 14 years. In April of 2000, a dive inspection revealed large areas of eroded concrete in the bays of the outlet works stilling basin. In one bay, the length of eroded area was approximately 28 feet in length to a maximum depth of 22 inches. Erosion due to abrasion erosion was so severe in some places that the reinforcing steel had been completely worn through. This discovery eventually led inspectors and operators to find additional problems with the basin that had been previously unknown. The type of material that had damaged the stilling basin in this manner was quite small, similar to pea-gravel ([figure 179](#)).





Figure 179.—Small aggregates can cause damage.

Although this material had not entered the basin via vandalism, this is a useful illustration of the potential for damage that can come from even small particles entering an energy dissipator.

### 13.4.2 Preventive measures

Preventive measures can be taken to reduce the potential for vandals to throw objects into energy dissipators:

- *Vertical barriers.*—Placing vertical barriers between potential sources of rock and stilling basins can be an effective measure to reduce damage from rock-throwing vandals. The barriers are typically constructed of some type of fencing material, with metal chain link fencing used most commonly. Fencing is typically installed vertically, although inclined sections of fencing have been found to be quite effective (figure 180). Reinforced concrete walls, such as extensions from sidewalls of stilling basins, have also been utilized.

The height of the barrier should be coordinated with the size of the rock utilized near the energy dissipator. A minimum barrier height of 8 feet would be required to prevent most rocks capable of being lifted overhead from being dropped over the top of the fence by the vandal. Rocks capable of being thrown (50 lb or less) would require higher fencing.

- *Horizontal barriers.*—Horizontal barriers can be placed directly over the stilling basin, preventing rocks from entering the basin from vandals. A horizontal barrier also can have the added benefit of hiding the stilling basin from view, reducing temptation for the potential vandal. These coverings can be constructed of any type of material capable of supporting self-weight and potential live loads.



Figure 180.—Inclined fencing to reduce damage from vandalism (Reclamation, 1993, p. 1).

Reinforced concrete would be an appropriate material for a cover over a small energy dissipator with a relatively short span length, particularly if the covering could be subjected to substantial live loads. Steel mesh grating could also be utilized for small span lengths subject to live loads from personnel. Longer span lengths would require the use of intermediate piers. Steel chain-link fencing could conceivably be used, although this material would not be suitable for foot traffic. Additionally, chain-link fencing could present a maintenance issue due to the difficulty in removing thrown material that had collected on top of the covering. One problem with chain link mesh is that small rock could still get through the openings.

A potential issue to evaluate prior to placing a barrier over an energy dissipator is the effect on air flow, or venting, of the structure during operation. Significant fluctuations in air pressures can be created during the operation of an energy dissipating structure. Research performed by Reclamation on a covered stilling basin, while testing a prototype deflector plate design, indicated that covering a large percentage of the basin created a “blow-hole” effect. Air pulses rushed from the open areas around the stilling basin, creating significant noise and vibration.

- *Source rock treatment.*—Discouraging or preventing the source rock from being picked up by vandals has shown to be a valuable method of preventing

vandalism from rock throwing. The source rock can either be grouted in place, or the rock can be of such size that it is difficult to pick up.

Grouting rock in place, as a means to prevent vandalism, must be consistent with the original intent of placing the rock at that location. Should the original intent of placing the rock include the ability of the rock to settle, or adjust, to changing foundation conditions, grouting could cause the rock to bridge over underlying voids? If the subgrade for the rock is relatively stable, grouting may be acceptable means to limit individual rocks from being picked up and thrown. Grouting also has the advantage of reducing the number of smaller rock pieces that may be d with the source rock.

Increasing the size of the rock to reduce the likelihood of it being picked up can also be effective. A minimum size of 80 pounds has been suggested as one possible criterion (USACE, 1994, p. 3-6). Obtaining rock without smaller stones interd, however, may be difficult. In addition, the bedding stones required to be placed beneath the larger stones could become exposed, providing a ready source of throwable rock.

- *Alternative materials.*—Other erosion resistant materials can be utilized as an alternative to rock which would reduce the likelihood of vandalism. Manufactured systems of concrete blocks, cabled together into mats, have been utilized in hydraulic structures with success (see [section 9.6](#)). These systems would tend to prevent the individual blocks from being removed, both due to the cabling interconnecting the blocks as well as the tendency for these units to become embedded in the soil/vegetative matrix. The site for these materials must be consistent with their intended use.

## References

The following references have been specifically cited in this manual.

Alexander, A. Michel, *Impacts on a Source of Acoustic Pulse-Echo Energy for Nondestructive Testing of Concrete Structures*, Technical Report REMR-CS-40, U.S. Army Engineer Waterways Experiment Station, Vicksburg, Mississippi, April 1993.

American Concrete Institute, *Guide to the Use of Waterproofing, Dampproofing, Protective, and Decorative Barrier Systems for Concrete*, ACI 515.1R, 1985.

American Concrete Institute, *Guide to Sealing Joints in Concrete Structures*, ACI 504R, 1990.

American Concrete Institute, *Guide for Making a Condition Survey of Concrete in Service*, ACI 201.1R, 1992.

American Concrete Institute, *Erosion of Concrete in Hydraulic Structures*, ACI 210R, 1993.

American Concrete Institute, *Guide for Evaluation of Concrete Structures Prior to Rehabilitation*, 364.R1, 1994.

American Concrete Institute, *Practices for Evaluation of Concrete in Existing Massive Structures for Service Conditions*, ACI 207.3R, 1994.

American Concrete Institute, *Cement and Concrete Terminology*, ACI 116R, 2000.

American Concrete Institute, *Guide to Durable Concrete*, ACI 201.2R, 2008.

Association of Diving Contractors International, *Consensus Standards for Commercial Diving and Underwater Operations*, 2004.

Ball, J.W. and W.P. Simmons, *Progress Report on Hydraulic Characteristics of Pipelines and Sudden Enlargements Used for Energy Dissipation*, Hydraulics Branch Report No. Hyd-519, Bureau of Reclamation, December 1963.

Ball, J.W., J.P. Tullis, and T. Stripling, "Predicting Cavitation in Sudden Enlargements," *ASCE Journal of the Hydraulics Division*, HY 4, July 1975.

Baston, Conrad R., *Preliminary Investigation of Culvert Outlet Baffle Block Geometry and Energy Dissipation*, Thesis submitted to the College of Engineering at West Virginia University, Morgantown, West Virginia, 2000.

## Outlet Works Energy Dissipators

---

Blaisdell, F.W., "The SAF Stilling Basin—A Structure to Dissipate the Destructive Energy in High Velocity Flow from Spillways," Agricultural Handbook No. 156, Agricultural Research Service and St. Anthony Falls Laboratory, Minneapolis, Minn., 1959.

Blaisdell, F.W. and C.L. Anderson, *Scour at cantilevered pipe outlets: Plunge pool energy dissipator design criteria*, ARS-76, Washington, D.C., USDA-ARS, 1989.

Bureau of Reclamation, *Progress Report I, Impact Type Energy Dissipators for flow at Pipe Outlets*, Laboratory Report No. Hyd-398, compiled by A.J. Peterka, March 4, 1955.

Bureau of Reclamation, *Progress Report IV—Research Study on Stilling Basins, Energy Dissipators, and Associated Appurtenances, Section 8, Stilling Basin for High Head Outlet Works Utilizing Hollow-Jet Valve Control (Basin VIII)*, Hydraulic Laboratory Report No. Hyd-446, 1960.

Bureau of Reclamation, *Hydraulic Model Studies of the Modified Outlet Works Stilling Basin*, HYD-573, 1967.

Bureau of Reclamation, *Hydraulic Model Studies of Vertical Stilling Wells*, REC-ERC-73-3, February 1973.

Bureau of Reclamation, *Hydraulic Model Studies of Plunge Basins for Jet-flow*, REC-ERC-74-9, 1974.

Bureau of Reclamation, *Hydraulic Design of Stilling Basin for Pipe or Channel Outlets*, Research Report No. 24, G.L. Beichley, 1978a.

Bureau of Reclamation, *Design of Small Canal Structures*, 1978b.

Bureau of Reclamation, A.J. Peterka, *Hydraulic Design of Stilling Basins and Energy Dissipators*, Engineering Monograph No. 25, May 1984.

Bureau of Reclamation, *Guidelines for Determining Whether Normally Inundated Outlet-Works Features Should Be Examined*, ACER Technical Memorandum No. 6, 1985.

Bureau of Reclamation, *Design of Small Dams*, 1987.

Bureau of Reclamation, *Preparing to Conduct a Dam Safety Inspection*, Training Aids for Dam Safety, 1988.

Bureau of Reclamation, *Criteria and Guidelines for Evacuating Storage Reservoirs and Sizing Low-Level Outlet Works*, ACER Technical Memorandum No. 3, 1990a.

- Bureau of Reclamation, *Cavitation in Chutes and Spillways*, Engineering Monograph No. 42, 1990b.
- Bureau of Reclamation, *Review of Operation and Maintenance Program Field Examination Guidelines*, 1991.
- Bureau of Reclamation, Design Standards No. 13, *Embankment Dams*, Chapter 19, “Geotextiles,” September 1992.
- Bureau of Reclamation, *Water Operation and Maintenance, Bulletin No. 166*, December 1993.
- Bureau of Reclamation, *Guide to Concrete Repair*, 1997.
- Bureau of Reclamation, Design Standards No. 13, *Embankment Dams*, Chapter 7, “Riprap Slope Protection,” 2001.
- Bureau of Reclamation, *Drainage for Dams and Associated Structures*, 2004.
- Bureau of Reclamation, Design Standards No. 13, *Embankment Dams*, Chapter 5, “Protective Filters,” 2007.
- Bureau of Reclamation, *Reclamation Safety and Health Standards*, 2009.
- Cai, J., J. Feng, and Z. Zhang, “Flood Tunnel with Orifices to Control Flow Rate,” *Fourth International Conference on Hydrosience and Engineering, Seoul Korea*, September 2000.
- Carino, Nicholas J., *Recent Developments in Nondestructive Testing of Concrete*, Advances in Concrete Technology, Canada Center for Mineral and Energy Technology, Ottawa, Canada, January 1992, pp. 281–328.
- Cement and Concrete Association of New Zealand, *Repairs to Concrete, Information Bulletin: IB 08*, Second Edition, Wellington, New Zealand, August 2005.
- Clopper, P.E and Y. Chen, “Minimizing Embankment Damage During Overtopping Flow,” FHWA-RD-88-181, McLean, VA: Office of Engineering and Highway Operations Research and Development, 1988.
- Clopper, P.E., “Hydraulic Stability of Articulated Concrete Block Revetment Systems During Overtopping Flow,” FHWA-RD-89-199, McLean, VA: Office of Engineering and Highway Operations Research and Development, 1989.
- Colorado Department of Transportation, *Drainage Design Manual*, Chapter 11, 2004.



## Outlet Works Energy Dissipators

---

Cooper, Chuck R., *Closed Circuit Television Inspection of Outlet Works and Spillway Conduits and Toe Drains*, ASDSO Annual Conference, 2005.

Crowe, C.T., J.A. Roberson, and Elgar, *Engineering Fluid Mechanics*, 9th edition, 2001.

Emmons, Peter. H., Alexander M. Vaysburd, and James E. McDonald, "A Rational Approach to Durable Concrete Repairs," *Concrete International*, Vol. 15, No. 9, September 1993, pp. 40–45.

Emmons, Peter. H., Alexander M. Vaysburd, and James E. McDonald, *Concrete Repair in The Future Turn Of The Century—Any Problems?*, *Concrete International*, Vol. 16, No. 3, March 1994, pp. 42–49.

Falvey, H.T., Bureau of Reclamation Experience with Flow-Induced Vibrations, *Practical Experiences with Flow-Induced Vibrations*, 1979.

Federal Energy Regulatory Commission, Division of Dam Safety and Inspections, *Guidelines for Public Safety at Hydropower Projects*, March 1992.

Federal Energy Regulatory Commission, Division of Dam Safety and Inspections, *Safety Signage at Hydropower Projects*, October 2001.

Federal Emergency Management Agency, *Technical Manual: Conduits through Embankment Dams: Best Practices for Design, Construction, Problem Identification and Evaluation, Inspection, Maintenance, Renovation, and Repair*, FEMA 484, September 2005.

Federal Emergency Management Agency, *Technical Manual: Plastic Pipe Used in Embankment Dams: Best Practices for Design, Construction, Problem Identification and Evaluation, Inspection, Maintenance, Renovation, and Repair*, FEMA P-675, November 2007.

Federal Highway Administration, *Introduction to Highway Hydraulics*, Hydraulic Design Series No. 4, Publication No. FHWA NHI 01-019, August 2001.

Federal Highway Administration, *Design of Roadside Channels with Flexible Linings*, HEC-15, 2005.

Federal Highway Administration, *Hydraulic Design of Energy Dissipators for Culverts and Channels*, HEC No. 14, July 2006.

- Fletcher, B.P. and J.L. Grace, "Practical Guidance for Estimating and Controlling Erosion at Culvert Outlets," Misc. Paper H-72-5, U.S. Army Engineer Waterways Experiment Station, Vicksburg, Mississippi, 1972.
- Geosynthetics Magazine, *Annual Specifier's Guide*.
- Hager, W.H., *Wastewater Hydraulics, Theory and Practice*, 1999.
- Harris County Flood Control District, *Design Manual for Articulating Concrete Block Systems*, 2001.
- Jansen, Robert B., *Advanced Dam Engineering for Design, Construction, and Rehabilitation*, 1988.
- Johnson, Michael C. and Rajesh Dham, "Innovative Energy-Dissipating Hood," *Journal of Hydraulic Engineering*, ASCE, August 2006.
- Johnson, P.L., Bureau of Reclamation, *Hydraulic Model Studies of Plunge Basins for Jet-Flow*, REC-ERC-74-9, 1974.
- Johnson, S.M., *Deterioration, Maintenance, and Repair of Structures*, New York, 1965.
- MacDonald, T.C., *Model Studies of Energy Dissipators for Large Culverts*, Hydraulic Engineering Laboratory Study HEL-13-5, University of California, Berkeley, November 1967.
- Malhotra, V.M., *Testing Hardened Concrete: Nondestructive Methods*, ACI Monograph No. 9, Detroit, Michigan, 1976.
- Malhotra, V.M. and Nicholas J. Carino, *Handbook on Nondestructive Testing of Concrete*, 2003.
- Maryland Department of the Environment, *Specifications for Soil Erosion and Sediment Control*, 1994.
- Mason, P.J., "The Choice of Hydraulic Energy Dissipator for Dam Outlet Works Based on a Survey of Prototype Usage," *Proceedings of the Institution of Civil Engineers*, 1982.
- McCleese, William F., *REMR Program Overview and Guide*, June 2000.
- McDonald, James E. and Roy L. Campbell, Sr., *The Condition of Corps of Engineers Civil Works Concrete Structures*, Technical Report REMR-CS-2, U.S. Army Engineer Waterways Experiment Station, Structures Laboratory, Vicksburg, Mississippi, April 1985.

McDonald, James, E., Alexander M. Vaysburd,, and Randall W. Poston, *Performance Criteria for Dimensionally Compatible Repair Materials*, High-Performance Materials and Systems Research Program, Information Bulletin 00-1, Vicksburg, Mississippi, January 2000.

Mercer, A.C., “Vane Failures of Hollow-Cone Valves,” *Proceedings, LAHR*, Stockholm, Sweden, 1970.

Miller, D.S., *Internal Flow Systems*, 1978.

Natural Resource Conservation Service (Soil Conservation Service), *Gated Outlet Appurtenances, Earth Dams*, Technical Release TR-46, 1969.

Natural Resource Conservation Service (Soil Conservation Service), *Riprap-Lined Plunge Pool for Cantilever Outlet*, Design Note 6, March 5, 1986.

Natural Resources Conservation Service, *Gradation Design of Sand and Gravel Filters*, National Engineering Handbook Part 633, Chapter 26, Washington, D.C., 1994.

Natural Resources Conservation Service, *Specifications for Construction Contracts*, National Engineering Handbook Part 642, Washington, D.C., 2001.

Natural Resources Conservation Service, *Filter Diaphragms*, National Engineering Handbook Part 628, Chapter 45, Washington D.C., 2007a.

Natural Resources Conservation Service, *Use of Articulating Concrete Block Revetment Systems for Stream Restoration and Stabilization Projects*, Technical Supplement 14L, 210, VI-NEH, 2007b.

New Zealand Society on Large Dams, *New Zealand Dam Safety Guidelines*, November 2000.

New York State Department of Environmental Conservation, *New York Standards and Specifications for Rock Outlet Protection*, 2005.

North Carolina Department of Environment and Natural Resources, *Dam Operation, Maintenance, and Inspection Manual*, 2007.

Numachi, F., M. Yamabe, and R. Oba, *Cavitation Effect on the Discharge Coefficient of the Sharp Edged Orifice Plate*, Journal of Basic Engineering, Transactions, ASME, March 1960.

Occupational Safety and Health Administration, *Commercial Diving Operations—General Industry*, Standards 29 CFR, Subpart T, 2004.

- Parmakian, John, "Structural Failures in Hydraulic Equipment," *Western Water and Power Symposium Proceedings*, April 1968, pp. B143-B147.
- Pugh, Clifford A. and Cassie C. Klumpp, *Hydraulic Modeling of Boating Hazards and Sedimentation—Union Avenue Dam, Denver, Colorado*, Bureau of Reclamation, 1988.
- Rahmeyer, W., "Energy Dissipation and Limiting Flow through Orifices," *ASCE Journal of Transportation Engineering*, Vol. 114, No. 2, March 1988.
- Rice, C.E. and K.C. Kadavy, "Riprap Design for SAF Stilling Basins," American Society of Agricultural Engineers, *Transactions of the ASAE*, Vol. 35, No. 6, 1992, pp. 1817–1825.
- Rice, C.E. and K.C. Kadavy, "Plunge Pool Design at Submerged Pipe Spillway Outlets," *Transactions of ASAE*, Vol. 37, No. 4, 1994, pp. 1167-1173.
- Rice, C.E. and K.C. Kadavy, "Riprap Design for Pipe Spillway Outlets:  $-1.0 \leq TW/D_o \leq 0.7$ ," American Society of Agricultural Engineers, *Transactions of the ASAE*, Vol. 38, No. 5, 1995, pp. 1405–1411.
- Russell, S.O. and J.W. Ball, "Sudden Enlargements Energy Dissipator for Mica Dam," *ASCE Journal of the Hydraulics Division*, HY 4, July 1967.
- Simons, Stephens, and Watts, *Riprapped Basins for Culvert Outfalls*, Highway Research Record No. 373, pp. 24-38, 1971.
- Soil Conservation Service, *Guide for the Use of Geotextiles*, Design Note 24, 1991.
- State of Pennsylvania, *Act 91 of 1998—Buoy and Sign Guidelines for Run-of-River Dams*, June 1998.
- State of Wisconsin, *Chapter NR 330—Warning Signs and Portages for Dams*, April 2005.
- State of Wisconsin Department of Natural Resources, *Milwaukee County Grounds Flood Project Including Wetland Water Quality Certification, Culverts on an Unnamed Tributary to The Menomonee River, Rehabilitation of Underwood Creek, a Diversion of Water from Underwood Creek and an Inlet on Underwood Creek*, June 2006.
- Strategic Development Council, *Vision 2020: A Vision for the Concrete Repair, Protection and Strengthening Industry*, Version 1.0, June 16, 2006.
- Thornton, H.T. and A.M. Alexander, *Development of Nondestructive Testing Systems for In Situ Evaluation of Concrete Structures*, Technical Report REMR-CS-10, U.S. Army Engineer Waterways Experiment Station, Vicksburg, Mississippi, December 1987.

## Outlet Works Energy Dissipators

---

Tullis, J. Paul, *Hydraulics of Pipelines, Pumps, Valves, Cavitation, Transients*, 1989.

U.S. Army Corps of Engineers, *Impact-Type Energy Dissipator for Storm Drainage Outfalls Stilling Well Design*, TR 2-620, U.S. Army Engineer Waterways Experiment Station, Vicksburg, Mississippi, March 1963.

U.S. Army Corps of Engineers, *Hydraulic Design Criteria, Sheet 712-1 Stone Stability - Velocity vs. Stone Diameter*, U.S. Army Engineer Waterways Experiment Station, Vicksburg, Mississippi, 1970.

U.S. Army Corps of Engineers, *Hydraulic Design Criteria, Sheets 722-1 to 722-3, Storm Drain Outlets, and Energy Dissipators*, U.S. Army Engineer Waterways Experiment Station, Vicksburg, Mississippi, 1973.

U.S. Army Corps of Engineers, *Hydraulic Design of Reservoir Outlet Works*, EM 1110-2-1602, 1980.

U.S. Army Corps of Engineers, *Engineering and Design—Drainage and Erosion Control Mobilization Construction*, EM 1110-3-136, 1984.

U.S. Army Corps of Engineers, *Case History of Underwater Concrete Repair: Repair of Stilling Basin, Webbers Falls Lock and Dam, Arkansas River, Using Tremie Concrete*, REMR Technical Note CS-MR-8.1, 1985.

U.S. Army Corps of Engineers, *Crack Repair Method: Stitching*, REMR Technical Note CS-MR-3.5, 1985.

U.S. Army Corps of Engineers, *Specialized Repair Technique: Repair of Structures Damaged by Abrasion-Erosion*, REMR Technical Note CS-MR-9.1, 1985.

U.S. Army Corps of Engineers, *Underwater Nondestructive Testing of Metal Structures (Training for Divers)*, REMR Technical Note CS-ES-1.6, 1988.

U.S. Army Corps of Engineers, *Hydraulic Design of Spillways*, EM 1110-2-1603, 1990.

U.S. Army Corps of Engineers, *Design and Construction of Grouted Riprap*, Technical Letter No. 1110-2-334, August 1992.

U.S. Army Corps of Engineers, *Rapid Hardening Cements and Patching Materials*, REMR Technical Note CS-MR-7.3, 1992.

U.S. Army Corps of Engineers, *Hydraulic Design of Flood Control Channels*, EM 1110-2-1601, 1994.

- U.S. Army Corps of Engineers, *Standard Practice for Concrete for Civil Works Structures*, EM 1110-2-2000, 1994.
- U.S. Army Corps of Engineers, *Engineering Use of Geotextiles*, TM 5-818-8, 1995a.
- U.S. Army Corps of Engineers, *Engineering and Design: Evaluation and Repair of Concrete Structures*, EM 1110-2-2002, 1995b.
- U.S. Army Corps of Engineers, *Periodic Inspection and Continuing Evaluation of Completed Civil Works Structures*, ER 1110-2-100, February 15, 1995c.
- U.S. Army Corps of Engineers, *Waterstops and Other Joint Materials*, EM 1110-2-2102, 1995d.
- U.S. Army Corps of Engineers, *Flood Control Operations and Maintenance Policies*, ER 1130-2-530, October 30, 1996.
- Urban Drainage and Flood Control District, *Drainage Criteria Manual*, Denver, Colorado, 2008.
- West Virginia Department of Transportation, Division of Highways, *Effectiveness of West Virginia Department of Highways Standard Baffle Design at Culvert Outlets*, Final Report: RP #142, Principal Investigator, Robert N. Eli, Department of Civil and Environmental Engineering, West Virginia University, April 2002.
- Wittler, R.J., G.W. Annandale, S.R. Abt, J.F. Ruff, "New Technology for Estimating Plunge Pool or Spillway Scour," *Proceedings of the 1998 Annual Conference of the Association of State Dam Safety Officials*, 1998.
- WRC Engineering, Inc., *Boulder County Storm Drainage Criteria Manual*, Denver, Colorado, 1984.
- Zhang, Q.Y. and B.Q. Chai, "Hydraulic Characteristics of Multistage Orifice Tunnels," *ASCE Journal of Hydraulic Engineering*, Vol. 127, No. 8, August 2001, pp. 663–668.
- Zhang, Z. and J. Cai, "Compromise Orifice Geometry to Minimize Pressure Drop," *ASCE Journal of the Hydraulic Engineering*, HY 11, November 1999.





## Additional Reading

The following references have not been specifically cited within this manual and are provided as suggested “additional reading.” These references are intended to assist the user with furthering their understanding of topics related to outlet works energy dissipators and dams. The reader will find additional references related to outlet works and embankment dams in FEMA’s *Technical Manual: Conduits through Embankment Dams*, 2005.

Sound engineering judgment should always be applied when reviewing any of these references. While most of these references contain valuable information, a few may contain certain information that has become outdated in regards to design and construction aspects and/or philosophies. Readers are cautioned to keep this in mind when reviewing these references for design and construction purposes.

The reader may want to periodically visit a particular agency or organization’s website for updates or revisions to these references.

Abt, Steven R., Glenn B. Hamilton, Chester C. Watson, and John Smith, “Riprap Sizing for Modified ARS-Type Basin,” ASCE, *Journal of Hydraulic Engineering*, Vol. 120, No. 2, February, 1994.

Akbari, M.E., M.K. Mittal, and P.K. Pande, *Pressure Fluctuations on the Floor of Free and Forced Hydraulic Jumps*, Paper C1, Hydraulic Modeling of Civil Engineering Structures, Coventry, England, September 22–24, 1982.

Alaska Power Authority, *Scour Hole Development Downstream of High-Head Dams*, Subtask 6.14, March 1982.

American Society for Testing and Materials, *Annual Book of ASTM Standards* (Annual).

American Society of Civil Engineers, “Energy Dissipators for Spillways and Outlet Works, Progress Report of the Task Force on Energy Dissipators for Spillways and Outlet Works Committee on Hydraulic Structures,” *Journal of the Hydraulics Division, Proceedings of the ASCE*, Vol. 90, No. HY1, January, 1964.

Anderson, Clayton L., “Erosion Control at Pipe Outlets,” *Proceedings of the Symposium on Surface Water Impoundments*, ASCE, June 2–5, 1980.

Anderson, C.L., *Plunge Pool Energy Dissipator*, Paper No. 81-2574, for presentation at the 1981 Winter Meeting, American Society of Agricultural Engineers, Palmer House, Chicago, Illinois, December 15–18, 1981.

Annandale, George W., “Scour of Rock Case Study, Rico Bayo Dam,” *ASDSO Conference Proceedings*, 2006.

Armengou, J. and D.A. Ervine, “Mean and fluctuating pressure field in full width free nappe stilling basin,” *Proceedings of the 24th LAHR Congress, Models and Control System for Hydraulic Engineering, Madrid, Spain, September 9–13, 1991*, Vol. D., 1991, pp. 261–269.

Armenio, V., P. Toscano, and V. Fiorotto, “On the effects of a negative step in pressure fluctuations at the bottom of a hydraulic jump,” *Journal of Hydraulic Research*, Vol. 38, No. 5, 2000.

Asmathullah, H. Md., M.C. Deo, and P.B. Deolalikar, “Neural Networks for Estimation of Scour Downstream of a Ski-Jump Bucket,” ASCE, *Journal of Hydraulic Engineering*, Vol. 131, No. 10, October 1, 2005.

Bacciega, Jorge D., Claudio A. Fattor, and Hector D. Barrionuevo, *Environmental Considerations in the Design of Spillways: Analysis of Hydrodynamic Behavior*, Programa Hidraulica de Obras, Laboratorio de Hidraulica y del Ambiente, Instituto Nacional del Agua y del Ambiente (INA), translated to English, date unknown.

Bakhmeteff, Boris A. and Arthur E. Matzke, “The Hydraulic Jump in Terms of Dynamic Similarity,” *ASCE Transactions*, 1936.

Basco, D.R., *Trends in Baffled, Hydraulic Jump Stilling Basin Designs of the Corps of Engineers Since 1947*, Miscellaneous Paper H-69-1, U.S. Army Engineer Waterways Experiment Station, Vicksburg, Mississippi, January 1969.

Basco, D.R., *An Experimental Study of Drag Forces and Other Performance Criteria of Baffle Blocks in Hydraulic Jumps*, Miscellaneous Paper H-70-4, U.S. Army Engineer Waterways Experiment Station, Vicksburg, Mississippi, May 1970.

Basco, David R. and John R. Adams, “Drag Forces on Baffle Blocks in Hydraulic Jumps,” *Journal of the Hydraulics Division, Proceedings of the ASCE*, Vol. 97., No. HY12, December 1971.

BC Environment, *Dam Safety Guidelines: Inspection and Maintenance of Dams*, Water Management Branch, Public Safety Section, 1998.

B.C. Hydro, *Hugh Keenleyside Dam: Energy Dissipation Basin, Investigation of Erosion Problems*, Vancouver, B.C., International Power and Engineering Consultants, 1972.

Beichley, G.L., *Hydraulic model studies of an energy dissipator for a fixed-cone valve at the Ute Dam outlet works*, Bureau of Reclamation, Interstate Stream Commission, 1970.

Beichley, G.L. and A.J. Peterka, "Hydraulic Design of Hollow-Jet Valve Stilling Basins," *ASCE Transactions*, Vol. 127, Part I, Paper No. 3296, 1932, pp. 210–245.

Bellin, Alberto, Fiorotto, and Virgilio, "Direct Dynamic Force Measurement on Slabs in Spillway Stilling Basins," *ASCE Journal of Hydraulic Engineering*, Vol. 121, No. 10, October 1995.

Bhowmik, Nani G., "Stilling Basin Design for Low Froude Number," *Journal of the Hydraulics Division, Proceedings of the ASCE*, Vol. 101, No. HY7, July 1975.

Blaisdell, Fred W., "The Use of Sand Beds for Comparing Relative Stilling Basin Performance," 23<sup>rd</sup> Annual Meeting of the American Geophysical Union, April 3–4, 1942, United States Department of Agriculture, Soil Conservation Service, October 1942.

Blaisdell, Fred W., *Development and Hydraulic Design, Saint Anthony Falls Stilling Basin*, *ASCE Transactions*, Vol. 113, Paper No. 2342, 1948, p. 483.

Blaisdell, Fred W., *Analysis of Scour Observations at Cantilever Outlets*, United States Department of Agriculture, Miscellaneous Publication Number 1427, July 1983.

Blaisdell, Fred W. and Charles A. Donnelly, "The Box Inlet Drop Spillway and its Outlet," *ASCE Transactions*, Vol. 121, Paper No. 2828, 1956, p. 955.

Blaisdell, Fred W. and Clayton L. Anderson, "Pipe Spillway Plunge Pool Design Equations," *Proceedings of the Conference Water for Resource Development, HY Div./ASCE Coeur d'Alene, Idaho, August 14–17, 1984*.

Blaisdell, Fred W. and Clayton L. Anderson, "A Comprehensive Generalized Study of Scour at Cantilevered Pipe Outlets," *LAHR Journal of Hydraulic Research*, Vol. 26, No. 4, 1988.

Blaisdell, Fred W. and Clayton L. Anderson, "Pipe Plunge Pool Energy Dissipator," *ASCE Journal of Hydraulic Engineering*, Vol. 117, No. 3, March 1991.

Blaisdell, Fred W., Clayton L. Anderson, and George G. Hebaus, "Ultimate Dimensions of Local Scour," *Journal of the Hydraulics Division, Proceedings of the ASCE*, Vol. 107, No. HY3, March 1981.

Bollaert, E. and A. Schleiss, "Scour of rock due to the impact of plunging high velocity jets, Part I: A state-of-the-art review," *LAHR Journal of Hydraulic Research*, Vol. 41, No. 5, 2003, pp. 451–464.

Bollaert, E., P. Manso, and A. Schleiss, "Dynamic pressure fluctuations at real-life plunge pool bottoms," *Proceedings of the International Conference on Hydraulics of Dams and River Structures, Tebran, Iran*, April 2004, pp. 117–124.

Borghei, S.M. and P. Zarnani, "Jet impact geometry and plunge pool dimensions effects on dynamic pressures at pool sidewalls," *Canadian Journal of Civil Engineering*, v 35, n 4, April 2008, p. 408–417.

Bowers, C. Edward and Frank Y. Tsai, "Fluctuating Pressures in Spillway Stilling Basins," *Proceedings of the ASCE*, Vol. 95., No. HY6, November 1969.

Bowers, C. Edward and Joel Toso, "Karnafuli Project, Model Studies of Spillway Damage," ASCE, *Journal of Hydraulic Engineering*, Vol. 114, No. 5, May 1988.

Bradley, J.N. and A.J. Peterka, "The Hydraulic Design of Stilling Basins: Hydraulic Jumps on a Horizontal Apron (Basin I)," *Journal of the Hydraulics Division, Proceedings of the ASCE*, Proc. Paper 1401, Vol. 83, No. HY5, October 1957.

Brevard, John A. and G.L. Beichley, *Criteria for the Hydraulic Design of Impact Basins Associated with Full Flow in Pipe Conduits*, USDA Soil Conservation Service, Technical Release No. 49, 1971.

Broehl, D.J. and J. Fisch, "Solution of Vibration Problems Experienced with Howell-Bunger Valves at Round Butte Dam," ICOLD, Istanbul, Turkey, Question 33, Response 20, 1967.

Bukreev, V.I., *Statistical Characteristics of the Pressure Fluctuation in a Hydraulic Jump*, Zhurnal Prikladnof Makhaniki I Tekhnicheskoi Fiziki, Vol. 7, No. 5, 1966, pp. 134–137.

Bureau of Reclamation, *Hydraulic Model Studies of the Regulating Gate and Stilling Well—Trenton Dam Canal Outlet Works—Missouri River Basin Project*, Hydraulic Laboratory Report No. Hyd-300, April 11, 1951.

Bureau of Reclamation, *Progress Report II, Research Study on Stilling Basins, Energy Dissipators, and Associated Appurtenances*, Report No. Hyd-399, June 1, 1955.

Bureau of Reclamation, *Progress Report III, Research Study on Stilling Basins, Energy Dissipators, and Associated Appurtenances, Section 7—Slotted and Solid Buckets for High, Medium and Low Dam Spillways*, Report No. Hyd-415, July 1, 1956.

Bureau of Reclamation, *Progress Report V, Research Study on Stilling Basins, Energy Dissipators, and Associated Appurtenances, Section 9, Baffled Apron on 2:1 Slope for Canal or Spillway Drops (Basin IX)*, Report No. Hyd-445, April 28, 1961.

Bureau of Reclamation, *Progress Report VII—Research Study on Stilling Basins, Energy Dissipators, and Associated Appertunances—Section 13 Stilling Basins for High Head Outlet Works with Slide-Gate Control (Preliminary Studies)*, Report No. Hyd-544, 1965.

Bureau of Reclamation, *Report on Inspection of Folsom Dam Stilling Basin, October 1965*, 1966.

Bureau of Reclamation, *Progress Report No. XIII—Research Study on Stilling Basins, Energy Dissipators, and Associated Appurtenances—Section 14, Modification of Section 6 (Stilling Basin for Pipe or Open Channel Outlets—Basin VI)*, Report No. HYD-572, June 1969.

Bureau of Reclamation, *Studies to Determine the Feasibility of a Baffled Apron Drop as a Spillway Energy Dissipator, Conconully Dam Spillway, Okanogan Project, Washington*, REC-ERC-71-29, 1971.

Bureau of Reclamation, *Hydraulic Model Studies of the Teton Canal Outlet Works Energy Dissipator*, REC-ERC-74-16, 1974.

Bureau of Reclamation, *Hydraulic Tests and Development of Multijet Sleeve Valves*, REC-ERC-77-14, December 1977.

Bureau of Reclamation, *Low Froude Number Stilling Basin Design*, REC-ERC-78-8, 1978.

Bureau of Reclamation, *Computing Degradation and Local Scour, Technical Guideline for Bureau of Reclamation*, 1984.

Bureau of Reclamation, *Guidelines for Controlling Seepage along Conduits through Embankments*, ACER Technical Memorandum No. 9, 1987.

Bureau of Reclamation, *Hydraulic Model Studies of Upper Stillwater Dam Stepped Spillway and Outlet Works*, REC-ERC-87-6, 1987.

Bureau of Reclamation, *Downstream Hazard Classification Guidelines*, ACER Technical Memorandum No. 11, 1988.

Bureau of Reclamation, *Hydraulic Model Studies of a 52-Inch Multiported Sleeve Valve for Sixth Water Aqueduct Flow Structure*, R-93-12, July 1993.

Bureau of Reclamation, *Preliminary Evaluation of a Test Method for Determining the Underwater Abrasion-Erosion Resistance of Concrete*, GR-84-1, 1995.

Bureau of Reclamation, *Water Operation and Maintenance Bulletin No. 185*, December 1995.



Bureau of Reclamation, *Review/Examination Program for High- and Significant-Hazard Dams*, Reclamation Manual, Directives and Standards FAC 01-07, 1998.

Bureau of Reclamation, *Diving Safe Practices Manual—Underwater Inspection Program*, November 2006.

Bureau of Reclamation, *Erosion and Sedimentation Manual*, November 2006.

Burgi, P.H, D.P. Cosakos, H.T. Falvey, M.J. Sawka, S.J. Schlenker, and T.N Waller, "Investigation and Repair of the Outlet Works Tunnel Slab Damage—Seven Oaks Dam, Ana River, CA," IAHR Symposium on Hydraulic Structures, Ciudad Guayana, Venezuela, October 2006.

Burgi, Phillip H., Edward O. Green, and Raoul E. Thibault, "Multiport Sleeve Valve Development and Application," ASCE, *Journal of the Hydraulics Division*, January 1981, pp. 95–111.

Canadian Dam Association, Technical Bulletin: *Public Safety Signage around Dams*, February 2010 (Draft).

Cassidy, John J., Frederick A. Locher, Wing Lee, and T. Nakato, *Hydraulic Design for Replacement of Floor Blocks for Pit 6 Stilling Basin*, 18<sup>th</sup> ICOLD, Durban, 1994.

Castillo, L.G., J. Dolz, and J. Polo, "Analysis of data to characterize dynamic actions in hydraulic energy," *Proceedings of the 24th IAHR Congress, Models and Control System for Hydraulic Engineering, Madrid, Spain*, Vol. D, September 1991, pp. 271–280.

Chanson, H., "A Review of Accidents and Failures of Stepped Spillways and Weirs," *Proceedings of the Institution of Civil Engineers Water and Maritime Engineering*, 2000, Vol. 142, December 2000, pp. 177–188.

Chanson, H. and T. Brattberg, "Experimental Study of the Air-Water Shear Flow in a Hydraulic Jump," *International Journal of Multiphase Flow* 26, 2000, pp. 583–607.

Chow, Ven Te, *Open Channel Hydraulics*, 1959.

City of Lincoln Public Works and Utilities Department and the Lower Platte South Natural Resources District, *Drainage Criteria Manual*, May 10, 2004.

Coastal Structure Underwater Inspection Technologies, *Coastal Structure Underwater Inspection Technologies*, CETN-III-62, December 1996.

Colgate, D., *Hydraulic Model Studies of Corrugated Metal Pipe Underdrain Energy Dissipators*, REC-ERC-71-10, Engineering and Research Center, Bureau of Reclamation, Prepared for Forest Service, San Dimas California, January 1971.

- Concrete Repair Digest, *Removing Some Common Stains from Concrete*, February/March 1993.
- Cooper, Chuck, *Remotely Controlled Video Inspection of Conduits*, Department of the Interior Dam Safety Coordination Conference, Whitefish, Montana, 2000.
- Doddiah, D., M.L. Albertson, and R. Thomas, “Scour from Jets,” *Proceedings of the Minnesota International Hydraulics Conference*, ASCE, September 1953, pp. 161–169.
- Dolen, Timothy P., *Underwater Crack Repair*, Bureau of Reclamation, Materials Engineering and Research Laboratory, Report DSO-07-10, September 2007.
- Donnelly, Charles A., *Design of an Outlet for Box Inlet Drop Spillway*, United States Department of Agriculture, Soil Conservation Service—Research, November 1947.
- Donnelly, Charles A. and Fred W. Blaisdaell, “Straight Drop Spillway Stilling Basin,” ASCE, *Journal of the Hydraulics Division, Proceedings of the ASCE*, May 1965, pp. 101–145.
- Dulin, Richard V. and Juan Crofton, *Underwater Inspection: The Engineer vs. The Diver*, 2004 ASDSO Annual Conference, 2004.
- Ead, S.A. and N. Rajaratnam, “Hydraulic Jumps on Corrugated Beds,” ASCE, *Journal of Hydraulic Engineering*, Vol. 128, No. 7, July 1, 2002.
- Elder, R.A. and J.M. Dougherty, “Characteristics of d-Dispersion Cone Valves,” *Proceedings of the ASCE*, Vol. 78, Separate 153, September 1952.
- Elder, R.A. and G.C. Dougherty, “Hydraulic Characteristics of Howell-Bunger Valves and Their Associated Structures,” Tennessee Valley Authority, November 1950.
- Falvey, H.T., *Cavitation: Basics and Hydraulic Structures*, 2010.
- Farhoudi, Javad, Narayanan, and Rangaswami, “Force on Slab Beneath Hydraulic Jump,” ASCE, *Journal of Hydraulic Engineering*, Vol. 117, No. 1, January 1991.
- Federal Emergency Management Agency, *Dam Safety: Hazard Potential Classification Systems for Dams*, Mitigation Directorate, FEMA 333, October 1998.
- Fiorotto, Virgilio, Rinaldo, and Andrea, “Fluctuating Uplift and Lining Design in Spillway Stilling Basins,” *ASCE Journal of Hydraulic Engineering*, Vol. 118, No. 4, April 1992.
- Fiorotto, Virgilio, Rinaldo, and Andrea, “Turbulent Pressure Fluctuations under Hydraulic Jumps,” *LAHR Journal of Hydraulic Research*, Vol. 30, No. 4, 1992.

- Fiorotto, Virgilio, Salandin, and Paolo, "Design of Anchored Slabs in Spillway Stilling Basins," *ASCE Journal of Hydraulic Engineering*, July 2000.
- Flammer, G.H., G.V Skogerboe, C.Y. Wei, and H. Rasheed, "Closed Conduit to Open Channel Stilling Basins," *Journal of the Irrigation and Drainage Division, Proceedings of ASCE*, Vol. 96, pp. 1–10.
- Fletcher, B.P. and P.E. Saunders, *Dynamic Loading on Sidewall Monoliths of Spillway Stilling Basins*, Tech Report HL-88-10, U.S. Army Engineer Waterways Experiment Station, Vicksburg, Mississippi, 1988.
- Franzetti, S. and M.G. Tanda, "Analysis of turbulent pressure fluctuation caused by a circular impinging jet," International Symposium on New Technology in Model Testing in Hydraulic Research, India, September 1987.
- Frizell, Kathleen H., *Spillway, Outlet Works, and Water Conveyance Structure Needs—Survey Results*, Bureau of Reclamation, Hydraulic Laboratory Report HL-2005-03, October 2005.
- Frizell, K. Warren, *Uplift and Crack Flow Resulting from Discharges Over Open Offset Joints*, Bureau of Reclamation, Water Resources Research Laboratory Group, Report DSO-07-07, December 2007.
- Garde, R.J. and P.D. Saraf, "Evolution of design of energy dissipator for pipe outlets," *ASCE Journal of Irrigation and Power*, 1986, pp. 145–154.
- Gibson, A.H., "The Conversion of Kinetic to Potential Energy in the Flow of Water Through Passages Having Divergent Boundaries," *Engineering*, Vol. 93, 1914, p. 205.
- Goel, Arun, "Experiments on Stilling Basins for Dam Outlets," *Proceedings of the Institution of Civil Engineers*, Issue WM4, pages 203–206, Paper 14254, December 2007.
- Goel, Arun and D.V.S Verma, "Alternate design of stilling basins for pipe outlets," *ASCE Journal of Irrigation and Drainage Systems*, Springer, Vol. 20, No. 3, pp. 139–150.
- Goel, Arun and D.V.S. Verma, "Improved design of energy dissipators for pipe outlets," *ASCE Journal of Irrigation and Drainage Systems*, The Netherlands, Vol. 13, No. 4, 1999, pp. 313–320.
- Goel, Arun and D.V.S Verma, "Model studies on stilling basins for pipe outlets," *ASCE Journal of Irrigation and Drainage Systems*, The Netherlands, Vol. 15, No. 1, 2001, pp. 81–91.
- Goel, Arun, "Design of Stilling Basins," *International Water Power and Dam Construction*, July 2007.

- Gomasta, S.K., M.K. Mittal, and K.P. Pande, *Hydrodynamic Forces on Baffle Blocks in Hydraulic Jump*, 17<sup>th</sup> Congress, IAHR, Baden-Baden, 1977.
- Grace, J.L. and G.A. Pickering, *Evaluation of Three Energy Dissipators for Storm-Drainage Outlets*, Hydraulic Laboratory Investigation, Research Report H-71-1, U.S. Army Engineer Waterways Experiment Station, Vicksburg, Mississippi, April 1971.
- Gwinn, Wendell R., *Model Study of a Box-Inlet Chute Spillway and SAF Stilling Basin*, U.S. Department of Agriculture, Science and Education Administration, Agricultural Reviews and Manuals, ARM-S-17, July 1981.
- Hager, Willi H., “B-jump in Sloping Channels,” *LAHR Journal of Hydraulic Research*, Vol. 27, No. 1, 1989.
- Hager, Willi, “Plunge Pool Scour: Early History and Hydraulicians,” ASCE, *Journal of Hydraulic Engineering*, December 1998.
- Hager, W.H., R. Bremen, and N. Kawagoshi, “Classical Hydraulic Jump: Length of Roller,” *LAHR Journal of Hydraulic Research*, Vol. 28, No. 5, 1990.
- Hampton, Neill J. and James Constantino, “Rehabilitation of the Diversion Tunnel Outlet Works at Cobble Mountain Reservoir Dam,” *Journal NEWWA*, March 2008.
- Hanna, Leslie, *Mason Dam Flow Deflectors for Preventing Stilling Basin Abrasion Damage*, Bureau of Reclamation, Hydraulic Laboratory Report HL-2005-01, October 2005.
- Hanna, Leslie, “Flow Deflectors to Prevent Stilling Basin Abrasion Damage,” Bureau of Reclamation, *Western Water and Power Solution Bulletin*, Research and Development Office—Denver, Colorado, Bulletin No. 1, June 2007.
- Hart, E.D., “Sluice Pressures, Gate Vibrations, and Stilling Basin Wall Pressures, Libby Dam, Kootenai River, Montana,” Technical Report H-76-17, U.S. Army Engineer Waterways Experiment Station, CE, Vicksburg, Mississippi, October 1976.
- Hartung, R. and E. Hausler, “Scours stilling basins and downstream protection under free overfall jets at dams,” *Proceedings of the 11th International Congress on Large Dams*, Madrid, Spain, 11–15 June 1973, Vol. II. pp. 39–56.
- Hartung, F. and Knauss, J., “Developments to Improve Economy, Capacity, and Efficiency of Structures Controlling the Passage of Flood Water through Reservoirs,” *Transactions of the 9<sup>th</sup> ICOLD Congress*, Istanbul, Turkey, Question 33, R14, 1967, pp. 227–249.
- Henry T. Falvey and Associates, Inc., *Seven Oaks Dam: Review of Damage to Invert*, June 17, 2005.

Husain, D., Abdel-Azim M. Negm, and A.A. Alhamid, "Length and Depth of Hydraulic Jump in Sloping Channels," *ASCE Journal of Hydraulic Research*, Vol. 32, No. 6, 1994.

Jansen, Robert B., editor, *Advanced Dam Engineering for Design, Construction and Rehabilitation*, Van Nostrand Reinhold, 1988.

Johnson, Geoffrey, "The Effect of Entrained Air on the Scouring Capacity of Water Jets," *Proceedings, Twelfth Congress of International Association of Hydraulic Research*, Vol. 3, Fort Collins, Colorado, 1967.

Keim, R.S., "The Contra Costa Energy Dissipator," *Journal of Hydraulic Division*, ASCE Paper 3077, March 1962, p. 109.

Khatsuria, R.M., Dispersive-Flow Energy Dissipator, "Discussion," ASCE, *Journal of Hydraulic Engineering*, ASCE, June 1996.

Khatsuria, R.M., *Hydraulics of Spillways and Energy Dissipators*, Marcel Dekker (publisher), 2005.

Kline, Robert A, *Innovations in Outlet Works Repairs*, ASDSO, 1992.

Knox County Tennessee, *Stormwater Management Manual*, Vol. 2, Section 7.5, year of publication unknown.

Lever, James H., Gary E. Phetteplace, Weale, and Jason C, *Benefits of Using Remotely Operated Vehicles to Inspect USACE Navigation Structures*, U.S. Army Corps of Engineers Cold Regions Research and Engineering Laboratory, ERDC/CRREL TR-07-4, March 2007.

Lever, James H., Gary E. Phetteplace, *Demonstration of Remotely Operated Vehicles to Aid Underwater Inspection of Corps of Engineers Navigation Structures, Winfield Locks and Dam*, U.S. Army Corps of Engineers Cold Regions Research and Engineering Laboratory, ERDC/CRREL TR-08-15, September 2008.

Liu, Tony C. and James E. McDonald, *Abrasion-Erosion Resistance of Fiber-Reinforced Concrete*, Miscellaneous Paper SL-81-32, U.S. Army Corps of Engineers, November 1981.

Locher, Frederick A., *Some Characteristics of Pressure Fluctuations on Low-Ogee Crest Spillways Relevant to Flow-Induced Structural Vibrations*, U.S. Corps of Engineers Contract No. DACW39-68-C-004, IIHR Report No. 130, February 1971.

Lopardo, R.A., J.C. De Lio, and G.F. Vernet, *Physical Modelling of Cavitation Tendency for Macroturbulence of Hydraulic Jump*, International Conference on the Hydraulic

- Modelling of Civil Engineering Structures, Coventry, England, September 22–24, 1982.
- Martins, Rui B.F., “Scouring of Rocky River Beds by Free Jet Spillways,” *International Water Power and Dam Construction*, Vol. 27, No. 5, England, pp. 152–153, April 1975.
- Mason, Peter J. and Kanapathypilly Arumugam, “Free Jet Scour Below Dams and Flip Buckets,” ASCE, *Journal of Hydraulic Engineering*, Vol. III, No. 2, February 1985, pp. 220–235.
- Maynard, Stephen T., *Practical Riprap Design*, Miscellaneous Paper H-78-7, U.S. Army Engineer Waterways Experiment Station, Vicksburg, Mississippi, June 1978.
- Maynard, Stephen T., *Riprap Stability: Studies in Near-Prototype Size Laboratory Channel*, Technical Report HL-92-5, U.S. Army Engineer Waterways Experiment Station, Vicksburg, Mississippi, June 1992.
- Mefford, Brent, *Sugar Pine Sleeve Valve Tests*, USBR Research and Lab Services, October 4, 1985.
- Melo, J.F., A.N. Pinheiro, and C.M. Ramos, “Forces on plunge pool slabs: Influence of joints location and width,” ASCE, *Journal of Hydraulic Engineering*, Vol. 132, No. 1, 2006, pp. 49–60.
- Merino, Sara R. Vegas, J. Reyes Salazar, and Cliff J. Schexnayder, “Use of Rock Blocks to Protect the Downstream Zone of a Hydraulic Discharge Structure,” *Practice Periodical On Structural Design and Construction*, ASCE, Vol. 10, No. 1, February 1, 2005.
- Miller, E., “Flow and Cavitation Characteristics of Control Valves,” *Journal of the Institution of Water Engineers*, Vol. 22, No. 7, October 1968, pp. 7–16.
- Narasimhan, S. and Ved P. Bhargava, “Pressure Fluctuations in Submerged Jump,” *Journal of the Hydraulics Divisions, Proceedings of the ASCE*, Vol. 102, HY3, March, 1976.
- Narayanan, Rangaswami and Loizos S. Schizas, “Force Fluctuations on Sill of Hydraulic Jump,” ASCE, *Journal of the Hydraulics Division*, Vol. 106, No. HY4, April 1980.
- Narayanan, Rangaswami and Loisois S. Schizas, “Force on Sill of Forced Jump,” *Journal of the Hydraulics Division, Proceedings of the ASCE*, Vol. 106, No. HY7, July 1980.
- Natural Resources Conservation Service, *Structural Design of SAF Stilling Basins*, Technical Release No. 54, Design Unit, October 1974.



Natural Resources Conservation Service, *Earth Spillway Erosion Model*, National Engineering Handbook Part 628: Dams, 210-vi-NEH, August 1997.

Natural Resources Conservation Service, *SITES Water Resource Site Analysis Computer Program*, Manual and Quickstart Guide, Version 2000.5, March 2005.

Negm, Abdel-Azim, "Hydraulic Jumps at Positive and Negative Steps on Sloping Floors," *IAHR Journal of Hydraulic Research*, Vol. 34, No 3, 1996.

Neilson, F.M., *Howell-Bunger Valve Vibration Summersville Dam Prototype Tests*, Technical Report H-71-6, U.S. Army Engineer Waterways Experiment Station, Vicksburg, Mississippi, September 1971.

Novak, P, A.I.B. Moffat, C. Nalluri, and R. Narayanan, *Hydraulic Structures*, Third Edition, Spon Press, 2001.

O'Connor, Robert W. and Joseph S. Haugh, *Televised Inspection of Aging Flood Control Structures to Assist in Prioritizing Maintenance Needs and Funding*, Date Unknown.

Ohtsu, I. and Y. Yasuda, "Hydraulic Jump in Sloping Channels," ASCE, *Journal of Hydraulic Engineering*, Vol. 117, No. 7, July 1991.

Oswalt, N.R., *Pomona Dam Outlet Stilling Basin Modifications*, Memorandum Report, U.S. Army Engineer Waterways Experiment Station, Vicksburg, Mississippi, 1971.

Oswalt, N.R., *Outlet Works Stilling Basin for Tallabala Dam, Tallabala Creek Mississippi, Hydraulic model Investigation*, Technical Report H-73-5, U.S. Army Engineer Waterways Experiment Station, Vicksburg, Mississippi, April 1973.

Paul, Dave and and Tom Scobell, *Rehabilitation of Lake Sherburne Dam Outlet Works Using Silica Flume Concrete*, USSD Annual Conference, 2009.

Pennino, Larsen, *Measurement of Flow Induced Forces on Floor Blocks, Pit 6 Dam Model Study*, Alden Research Laboratory, Worcester Polytechnic Institute, ASCE, July 1977.

Pillai, N.N. and Goel, Arun, *Stilling basins for low Froude number using wedge shaped blocks*, Ninth Congress of Asian and Pacific Division of IAHR, Singapore, 1994.

Pillai, N.N. and T.E. Unny, "Shapes of appurtenances in stilling basins," *Journal of the Hydraulic Division, Proceedings of ASCE*, Vol. 90, 1964, pp. 1–21.

Pillai, N. Narayana, Goel, Arun, Dubey, and Ashoke Kumar, "Hydraulic Jump Type Stilling Basin for Low Froude Numbers," ASCE, *Journal of Hydraulic Engineering*, Vol. 115, No. 7, July 1989.

- Prakash, Anand, *Water Resources Engineering, Handbook of Essential Methods and Design*, ASCE Press, 2004.
- Rajaratnam, Nallamuthu, Murahari, and Valupadas, “Flow Characteristics of Sloping Channel Jumps,” *Journal of the Hydraulics Division, Proceedings of the ASCE*, Vol. 100, No. HY6, June 1974.
- Rakhmanov, A.N., *Scouring Capacity of the Flow Below a Stilling Basin*, Izvestiia VNIIG, No. 105, 1974, pp. 223–246.
- Ranga Raju, K.G., M.K. Kitaal, M.S. Verma, and V.R. Ganeshan, “Analysis of Flow over Baffle Blocks and End Sills,” *LAHR Journal of Hydraulic Research*, Vol. 18, No. 3, 1980.
- Ree, William O., *Results of Tests on a Chute with a St. Anthony Falls Stilling Basin*, USDA Soil Conservation Service, September 1951.
- Ree, W.O., *Comparison of Chute and Stilling Basin Performance for Three Different Drop Box Inlets*, USDA Agricultural Research Service, ARS-S-126, July 1976.
- Rice, Charles E. and Fred W. Blaisdell, “Energy Dissipation Pool for a SAF Stilling Basin,” American Society of Agricultural Engineers, *Applied Engineering in Agriculture*, Vol. 3, No. 1, 1987, pp. 52–56.
- Rice, Charles E. and Kem C. Kadavy, “Scour at the Straight Drop Spillway with High Tailwater,” American Society of Agricultural Engineers, *Applied Engineering in Agriculture*, Vol. 5, No. 2, 1989, pp. 192–198.
- Rice, C.E. and K.C. Kadavy, “Riprap Design Downstream of Straight Drop Spillways,” American Society of Agricultural Engineers, *Transactions of the ASAE*, Vol. 34, No. 4, 1991, pp. 1715-1725.
- Rice, C.E. and K.C. Kadavy, “Riprap Design Upstream of Straight Drop Spillways,” American Society of Agricultural Engineers, *Transactions of the ASAE*, Vol. 35, No. 1, 1992, pp. 113–119.
- Rice, C.E. and K.C. Kadavy, “Riprap Design Downstream of Submerged Pipe Outlets,” American Society of Agricultural Engineers, *Transactions of the ASAE*, Vol. 37, No. 1, 1993, pp. 85–94.
- Rice, Charles E. and Kem C. Kadavy, *Velocity Reduction at a Submerged Pipe Outlet*, National Conference on Hydraulic Engineering and International Symposium on Engineering Hydrology, ASCE, San Francisco, California, July 25–30, 1993, pp. 228–233.

- Rice, Charles E. and Kem C. Kadavy, "Protection Against Scour at SAF Stilling Basins," ASCE, *Journal of Hydraulic Engineering*, ASCE, Vol. 119, No. 1, January 1993.
- Rice, C.E. and K.C. Kadavy, *Riprap Design for Pipe Spillways*, ASAE 1994 International Winter Meeting, December 1994.
- Rice, C.E., K.C. Kadavy, K.M. Robinson, and K.R. Cook, "Rock Chute Outlet Stability," American Society of Agricultural Engineers, *Applied Engineering in Agriculture*, Vol. 14, No. 2, pp. 145–148, 1998.
- Robinson, K.M. and K.C. Kadavy, "Low-Drop Grade-Control Structure," American Society of Agricultural Engineers, *Transactions of the ASAE*, Vol. 41, No. 5, pp. 1337–1341, 1998.
- Robinson, K.M. and K.C. Kadavy, *Hydraulic Modeling of a Low-Drop Grade Control Structure*, ASCE 1999 International Water Resources Engineering Conference, Seattle, WA, August 8–11, 1999.
- Robinson, K.M., C.E. Rice, and K.C. Kadavy, "Design of Rock Chutes," American Society of Agricultural Engineers, *Transactions of the ASAE*, Vol. 41, No. 3, pp. 621–626, 1998.
- Robinson, Kerry M., Charles E. Rice, and Kem C. Kadavy, *Velocity Downstream of a Submerged Pipe Outlet*, National Conference on Hydraulic Engineering and International Symposium on Engineering Hydrology, ASCE, San Francisco, California, 1993, pp. 1132-1136.
- Rouse, Hunter, Tien To Siao, and S. Nagaratnam, *Turbulence Characteristics of the Hydraulic Jump*, ASCE Transactions, Paper No. 3006, date unknown.
- Rudavsky, Alexander B., *Selection of Spillways and Energy Dissipators in Preliminary Planning of Dam Developments*, 12<sup>th</sup> ICOLD, Q 46, R 9, Mexico, 1976.
- Ruff, J.F., S.R. Abt, C. Mendoza, A. Shaikh and R. Kloberdanz, *Scour at Culvert Outlets in d Bed Materials*, Colorado State University Engineering Research Center Report No. FHWA/RD-82/011, Fort Collins, Colorado, 1982.
- Sanchez Bribiesca, Jose L., and Mariles Fuentes, Oscar A., *Experimental Analysis of Macroturbulence Effects on the Lining of Stilling Basins*, XI Congress on Large Dams, New Delhi, Q50, R6, 1979.
- Sarikelle, S. and Andrew L. Simon, *Field and Laboratory Evaluation of Energy Dissipators for Culvert and Storm Drain Outlets, Vol. I, Modular Energy Dissipators, Internal Energy Dissipators, Rock Channel Protection*, Book VIII, University of Akron, Ohio, Department of Civil Engineering, 1980.

- Scherich, Erwin T., *Design of Spillways and Outlet Works for Dams, A Design Manual*, Parts I and II (3 volumes), Bureau of Reclamation, February 1988.
- Schweiger, Paul G., *The State-of-the-Art of Armoring Embankment Dams Using Articulating Concrete Blocks*, ASDSO, 2001.
- Senturk, Fuat, Ph.D., *Hydraulics of Dams and Reservoirs*, Water Resources Publications, 1994.
- Smith, C.D., "Outlet structure design for conduits and tunnel," *ASCE Journal of Waterway, Port, Coastal and Ocean Engineering*, Vol. 114, 1988, pp. 505–513.
- Spoljaric, A., C. Maksimovic, and G. Hajdin, *Unsteady Dynamic force Due to Pressure Fluctuations on the Bottom of an Energy Dissipator—An Example*, International Conference on the Hydraulic Modeling of Civil Engineering Structures, Coventry, England, September 22–24, 1982.
- Strassburger, A.G., *Spillway Energy Dissipator Problems*, Transactions of the 11<sup>th</sup> Congress Large Dams, Q41, R 16, pp. 249–268, 1973.
- Tancev, Ljubomir, *Dams and Appurtenant Hydraulic Structures*, 2005.
- Texas Commission on Environmental Quality, *Guidelines for Operation and Maintenance of Dams in Texas*, Chapter 5, Inspection Guidelines, year of publication unknown.
- Thompson, L.R., *Hydraulic Model Studies of Methods to Dissipate the High-Velocity Jet from the Regulating Valve in Tecolote Tunnel, Santa Barbara Project, California*, Bureau of Reclamation, Branch of Design and Construction, 1951.
- Toso, Joel and Edward Bowers, "Extreme Pressures in Hydraulic-Jump Stilling Basins," ASCE, *Journal of Hydraulic Engineering*, Vol. 114., No. 8, August 1988.
- Training Aids for Dam Safety, *Inspection of Spillways and Outlet Works*, 1987.
- Tullis, J.P. and W.J. Rahmeyer, *Spillway Models*, International Conference on the Hydraulic Modeling of Civil Engineering Structures, Coventry, England, September 22–24, 1982.
- U.S. Army Corps of Engineers, *Model Studies of Conduits and Stilling Basin, Bull Shoals Dam, White River Arkansas*, Technical Memorandum No. 2-234, U.S. Army Engineer Waterways Experiment Station, Vicksburg, Mississippi, June 1947.
- U.S. Army Corps of Engineers, *Wave Action and Breakwater Location Port Washington Harbor, Wisconsin*, Technical Memorandum No. 2-334, U.S. Army Engineer Waterways Experiment Station, Vicksburg, Mississippi, November 1951.

## Outlet Works Energy Dissipators

---

U.S. Army Corps of Engineers, *Report on Inspection of McNary Stilling Basin, 1957: McNary Lock and Dam, Columbia River, Oregon and Washington*, Walla Walla District, Washington, 1957.

U.S. Army Corps of Engineers, *Report of Downstream Channel Erosion Below Stilling Basin; McNary Lock and Dam, Columbia River, Oregon and Washington*, Walla Walla District, Washington, 1962.

U.S. Army Corps of Engineers, Seattle District, *Report on November 1961 Inspection of Experimental Pilot Repair, Stilling Basin Chief Joseph Dam, Chief Joseph Project, Columbia River, Washington*, 1962.

U.S. Army Corps of Engineers, *Evaluation of Flared Outlet Transitions, Hydraulic Model Investigation*, Research Report H-72-1, U.S. Army Engineer Waterways Experiment Station, Hydraulics Laboratory, Vicksburg, Mississippi, June 1972.

U.S. Army Corps of Engineers, "Stilling Basins for Reservoir Outlet Works," ETL 1110-2-193, August 30, 1974, U.S. Army Engineer Waterways Experiment Station, CE, Vicksburg, Mississippi, 1974.

U.S. Army Corps of Engineers, *Selection of a Crack Repair Method*, REMR Technical Note CS-MR-3.1, September 1985.

U.S. Army Corps of Engineers, *Crack Repair Method: Conventional Reinforcement*, REMR Technical Note CS-MR-3.6, September 1985.

U.S. Army Corps of Engineers, *Crack Repair Method: Drilling and Plugging*, REMR Technical Note CS-MR-3.3, September 1985.

U.S. Army Corps of Engineers, *Crack Repair Method: External Stressing*, REMR Technical Note CS-MR-3.4, September 1985.

U.S. Army Corps of Engineers, *Crack Repair Method: Routing and Sealing*, REMR Technical Note CS-MR-3.2, September 1985.

U.S. Army Corps of Engineers, *Crack Repair Method: Grouting (Portland-Cement and Chemicals)*, REMR Technical Note CS-MR-3.7, September 1985.

U.S. Army Corps of Engineers, *Crack Repair Method: Drypacking*, REMR Technical Note CS-MR-3.8, September 1985.

U.S. Army Corps of Engineers, *Crack Repair Method: Epoxy Injection*, REMR Technical Note CS-MR-3.9, September 1985.

U.S. Army Corps of Engineers, *Crack Repair Method: Flexible Sealing or Mastic Filling*, REMR Technical Note CS-MR-3.10, September 1985.

- U.S. Army Corps of Engineers, *Crack Repair Method: Polymer Impregnation*, REMR Technical Note CS-MR-3.11, September 1985.
- U.S. Army Corps of Engineers, *Hydrostatic Tests of Injection Ports Used for In Situ Repair of Concrete*, REMR Technical Note CS-MR-3.12, undated.
- U.S. Army Corps of Engineers, *Removal and Prevention of Efflorescence on Concrete and Masonry Building Surfaces*, REMR Technical Note CS-MR-4.3, Suppl 3, 1985.
- U.S. Army Corps of Engineers, *Cleaning Concrete Surfaces*, REMR Technical Note CS-MR-4.4, Supplement 3, 1985.
- U.S. Army Corps of Engineers, *Specialized Repair Technique: Repair of Structures Damaged by Cavitation-Erosion*, REMR Technical Note CS-MR-9.2, 1985.
- U.S. Army Corps of Engineers, *Instrumentation for Concrete Structures*, EM 1110-2-4300, November 30, 1987.
- U.S. Army Corps of Engineers, *Ice Harbor Dam: Sonic Mapping Stilling Basin Inspection*, Walla Walla District, Washington, 1989.
- U.S. Army Corps of Engineers, *McNary Dam, Dworshak Dam: Sonic Mapping Stilling Basin Inspection*, Walla Walla District, Washington, 1989.
- U.S. Army Corps of Engineers, *Retaining and Flood Walls*, EM 1110-2-2502, Department of the Army, U.S. Army Corps of Engineers, Washington, D.C., 1989.
- U.S. Army Corps of Engineers, *Engineering and Design, Design and Construction of Grouted RipRap*, Technical Letter No. 1110-2-334, 1992.
- U.S. Army Corps of Engineers, *Engineering and Design: Hydraulic Design of Spillways*, Engineer Manual 1110-2-1603, January 16, 1990 (original), August 31, 1992 (errata #1).
- U.S. Army Corps of Engineers, *Lower Monumental Lock and Dam, Snake River, Washington: Spillway Stilling Basin Inspection*, Walla Walla District, Washington, 1992.
- U.S. Army Corps of Engineers, *Specialized Repair Technique, Preplaced-Aggregate Concrete*, REMR Technical Note CS-MR-9.4, 1992.
- U.S. Army Corps of Engineers, *Strength Design for Reinforced Concrete Hydraulic Structures*, EM 1110-2-2104, Department of the Army, U.S. Army Corps of Engineers, Washington, D.C., 1992.
- U.S. Army Corps of Engineers, *Spall Repair*, REMR Technical Note CS-MR-4.5, 1994.



U.S. Army Corps of Engineers, *Evaluation and Repair of Concrete Structures*, Manual No. 1110-2-2002, June 1995.

U.S. Army Corps of Engineers, *Project Geotechnical and Concrete Materials Completion Report for Major USACE Projects*, ER 1110-1-1901, 1999.

U.S. Army Corps of Engineers, *Handbook for Concrete and Cement*, with quarterly supplements (all CRD-C designations), U.S. Army Engineer Waterways Experiment Station Vicksburg, Mississippi, 2002.

U.S. Army Corps of Engineers, *Seven Oaks Dam Downstream Tunnel Slab Failure*, Letter Report, Los Angeles District, Portland District, March 28, 2005.

U.S. Federal Highway Administration, *Keyed Riprap*, Oregon Department of Transportation, FHWA, Region 15, 1976.

Verma D.V.S. and A. Goel, "Stilling basins for pipe outlets using wedge shaped splitter block," *ASCE Journal of Irrigation and Drainage Engg.*, Vol. 126, No. 3, 2000, pp. 179–184.

Verma, D.V.S. and Arun Goel, "Development of Efficient Stilling Basins for Pipe Outlets," *ASCE Journal of Irrigation and Drainage Engg.*, Vol. 126, No. 3, 2003, pp. 194–200.

Vasiliev, O.F. and V.I. Bukreyev, "Statistical Characteristics of Pressure Fluctuation in the Region of Hydraulic Jump," *International Association for Hydraulic Research, Proceedings*, Vol. 2, September 11–14, 1967.

Vittal, Nandana and Ayed M. Al-Garni, "Modified Type III Stilling Basin—New Method of Design," *LAHR Journal of Hydraulic Research*, Vol. 30, No. 4, 1992.

Yang, Shou Long, "Dispersive-Flow Energy Dissipator," *ASCE, Journal of Hydraulic Engineering*, Vol. 120, No. 12, December 1994.

Zhang, D., Z. Liu and T. Jin, "Cavitation Inception Witnessed by Sound Pressure Level in Both Mosel Test and Prototype Observation," *Proceedings of the Fourth International Symposium on Cavitation*, California Institute of Technology, 2001.

# Index

## A

- AASHTO standards, xxxix, 196, 204
- Abbreviations, xxxi
- Abrasion erosion, 8, 20, 44, 45, 231–241, 252, 255, 256, 258, 262, 272, 273, 290, 291, 341
- ACB, *see* Articulated concrete blocks
- Access to structures, 11, 19, 36, 41, 46, 124, 126, 140, 153, 198, 200, 221, 224–230, 243, 247–251, 262, 279, 283–290
  - discouraging access, 283–287
  - land-based access barriers, 287, 288
  - preventing access, 283, 287–289
- Accidental loadings, 268, 269, 276
- Acid, 268, 269, 280, 282
- Agate Dam, 39, 52, 93
- Aggregate, 197, 233, 269, 270, 273, 274, 279, 292
- Alkali, 231, 268, 269, 270, 282
- Analysis, 19, 173–175, 204, 224, 228, 242, 261, 263, 267, 270, 275
- Anchors, 15, 40, 98, 141, 199, 206, 207, 210, 244, 281, 290
- Angle, 8, 41, 46, 47, 61, 69, 83, 84, 87, 93, 106, 114, 167, 187, 246, 248
- Appurtenances, 8, 23, 27, 31, 48, 60, 64, 104, 120, 236, 341
  - stilling basin appurtenances, 31–35
- Approach velocity, 213, 217, 220
- Aprons, 15, 32, 59, 63, 183–187, 189–191, 198, 211, 341
  - transitional riprap aprons, 183–192
- Areo basin, *see* Hook basin
- Arkabutla Dam, 273
- Articulated concrete blocks, 197, 199–210, 341
- ASTM standards, xl, 193, 194, 200, 205–208, 264, 267, 269
- Attack, chemical, 231, 268, 269, 270, 271, 280, 282
- Audible devices, 286

## B

Backfill, 9, 36, 43, 107, 108, 195, 209, 210, 214, 235, 238

Baffles

    baffle blocks, 33–34

    baffle pier, 31, 33, 53, 63, 217–219, 341

    baffled drop, 3, 1512, 48, 53, 211–220, 341

    standard baffle basin, 78–79

Barriers, 69, 287, 290, 292, 293, 342, 344, 345

    boat barriers, 287

    land-based access barriers, 287

Bedding

    filter bedding, 195

    granular bedding, 195–196

Benches, 289

Blocks, *see* Articulated concrete, baffle, chute, or concrete blocks

Boats, 231, 253, 283, 284, 286, 287, 290

Bonneted slide gates, 13, 109, 138, 140–142, 343

Bottom discharge sleeve valves, 127–128

Boulder County storm drainage design guidance, 187

Buoys, 284, 286

Butterfly valve, 132–134

## C

Cables, 15, 16, 28, 40, 41, 100, 191, 200, 201, 202, 203, 205, 207, 223, 244, 246, 248, 250, 251, 267, 290, 294, 341

Camera-crawler, , 40, 42, 246, 249, 250, 341

Camouflage, 287–289

Cantilevers, 10, 11, 36, 47, 81, 84, 86

Case histories, 3, 39, 42, 43, 44, 45, 63, 77, 81, 82, 88, 93, 104, 159, 167, 169, 170, 177, 205, 206, 233, 240, 250, 256, 262, 272, 273

Cast-iron slide gates, 138, 141–147, 344

Causes of damage, 262–277

    causes of distress and deterioration, 267–275

    relating symptoms to causes of distress/deterioration, 275–277

Cavitation, 4, 8, 13, 17, 20, 24, 32, 47–49, 52, 61, 69, 89, 94, 109, 113, 122, 126, 133, 137, 139, 143, 146, 148, 150, 153, 157–159, 165, 167, 169–181, 231–233, 235, 264, 266, 268, 273, 342, 343–347

    alternative methods of cavitation analyses, 175–177

    prevention, 170–173

    the Tullis method of cavitation analysis, 173–175

- CCTV, *see* Closed circuit television
- Cement, 9, 36, 45, 81, 86, 104, 147, 156, 192–196, 201, 208, 231–237, 240, 243, 246–250, 264, 269, 270, 273, 275, 277, 279, 280, 281, 284, 344, 345, 348
- Chambers, *see* Horizontal energy dissipation chambers
- Charts, 191–192
- Checklists, 74, 228, 229
- Chemical reactions, 268, 269–271, 276
- Chute blocks, 32–33
- Clamshell gates, 13, 14, 147–151, 258
- Clark Canyon Dam, 233
- Cleaning, 12, 31, 42–45, 73, 101, 227, 232, 247, 256–260, 272, 282
- Cleaning methods, 256–260
- Climbing team inspection, 244–245
- Clogging, 18, 31, 42, 95, 97, 127, 128
- Closed circuit television (CCTV), 248–251
- Coatings, 282
- Coefficients, 61, 79, 112, 116, 131, 134, 140, 148, 150, 153, 161–167, 170–175, 177, 180, 277, 280
- Colorado State University rigid boundary basin, 79–80
- Computations, 96, 177–178
- Concrete
- articulated concrete blocks, 199–210
  - concrete removal and preparation for repair, 281
  - design of concrete repairs, 277–281
  - maintenance of concrete, 281–282
  - riprap and concrete blocks, 183–210
- Concrete preparation, 208, 226, 228, 230, 277, 281, 282
- Concrete removal, 39, 42, 73, 84, 85, 140, 254, 256, 258, 259, 271, 278, 281, 342, 347
- Condition survey, 263–267
- Conditions, application, and service, 279–280
- Conduit outlet, 11–13, 18, 72, 91, 95, 101–108, 183, 188, 199, 220, 342
- energy loss computations for sudden expansion and inline orifices, 177–178
  - expansion to a channel, 101
  - expansion to a stilling basin, 104
  - expansion with a hydraulic jump, 101–104
- Conjugate depth, 24, 30–32, 36, 40, 49, 52, 53, 57, 58, 60, 63, 341
- Construction errors, 268, 271, 276
- Contraction, *see* Jet contraction
- Converging walls, 62
- Conversion factors, xxxiv
- Corrosion of embedded materials, 146, 156, 169, 199, 231, 235, 264, 266, 268, 271, 276
- Cracks, 37, 43, 193, 198, 233, 234, 238, 263, 264, 269, 270, 274, 281
- Critical flow, 1, 23, 342
- Critical velocity, 1, 9, 23, 213, 214, 217, 342

Culverts, 77, 79, 104, 187, 220  
Cutoff walls, 38

## D

Dams, 7, 9, 10, 19, 20, 21, 23, 37, 39, 40, 42, 43, 44, 45, 46, 63, 77, 81, 82, 88, 93,  
101, 104, 108, 112, 114, 116, 122, 130, 132, 137, 139, 140, 141, 142, 143,  
150, 154, 157, 159, 167, 168, 173, 177, 179, 184, 206, 221, 222, 223, 224,  
226, 228, 229, 238, 240, 250, 254, 256, 258, 261, 262, 272, 281, 283, 284,  
285, 286, 287, 290, 291, 342, 343, 346, 348  
Agate, 39, 52, 93  
Arkabutla, 273  
Clark Canyon, 233  
Elkhead Creek, 82  
Enid, 273  
Ganado, 77  
Guadalupe, 205, 206  
Kinzua, 44, 262  
Lucky Peak, 81  
Mason, 33, 45, 272  
Mica, 167  
Navajo, 37, 63  
Nilan North, 104  
Norman, 256  
Palisades, 44  
Pineview, 169  
Pomme de Terre, 273  
Pomona, 44, 262, 273  
Seven Oaks, 81, 88, 159, 169, 173, 177, 179  
Standley Lake, 82  
Twin Lakes, 42, 139, 250  
Virginia Smith, 39, 43, 240, 291  
Xiaolangdi, 169  
Databases, 280–281  
Debris, 8, 12, 16, 17, 18, 23, 44, 63, 77, 78, 81, 84, 92, 95, 97, 101, 113, 123, 127, 128,  
131, 150, 169, 195, 220, 224, 231, 233, 236, 237, 238, 240, 248, 249, 251,  
252, 256, 259, 272, 283, 286, 287  
Defects, 193, 221, 250, 264, 265, 266  
Deficiencies, 223, 228, 229, 233, 238, 262, 263  
Deflectors, 35, 44, 45, 46, 114, 120, 293  
Degradation, 107, 189, 194, 198, 212, 214, 215, 219  
Dentates, 24, 31, 33, 34, 35, 49, 53, 63, 89, 231, 232, 234, 235, 338

- 
- Depth—initial, sequent, conjugate, and tailwater, 28–31
- Deposits, 156, 237, 241, 256, 258, 259, 274
- Design considerations
- ACB systems, 205–208
  - additional design considerations, 16–19
  - baffled drops, 211–216
  - conduit outlet expansions, 106–108
  - high head applications, 93
  - low head applications, 95–98
  - plunge basins, 85–88
  - sudden enlargements and inline orifices, 173–178
  - transitional riprap below SAF stilling basins, 190–191
- Design guidance
- ACB systems, 205–208
  - baffled drops, 216–220
  - Boulder County storm drainage design guidance, 187
  - conduit outlet expansions, 104–106
  - HEC-14, 184–187
  - high head applications, 93
  - hydraulic design rock chart, 191–192
  - low head applications, 98–99
  - New York and Maryland design guidance, 184
  - plunge basins, 85–88
  - sudden enlargements and inline orifices, 173–182
  - sudden enlargements and inline orifices, 178–182
  - transitional riprap below SAF stilling basins, 190–191
- Design errors, 272
- Design of concrete repairs, 277–281
- Deterioration of concrete, 194, 221, 224, 231, 234, 263, 267–277, 280–282
- Devices, 44, 74, 109, 110, 120, 143, 209, 211, 238, 250, 253, 284, 286, 289, 290
- Dewatering, 11, 258, 342
- Diagnosis of causes of concrete damage, 262–277
- Dimensions, 24, 51, 65, 70, 72, 76, 78, 81, 84, 87, 106, 116, 124, 126, 161, 185, 187, 199, 218
- Discharge
- butterfly valves for regulating free discharge flow, 132–134
  - vertical stilling wells energy dissipator for bottom discharge sleeve valves, 127–128
- Discouraging access, 283–287
- Displacement, 86, 192, 193, 235, 237
- Distance between series of inline orifices, 177
- Distress, 228, 233, 263, 267–277, 281
- Dive team inspection, 239–244
- Downstream consequences, *see* Risk and downstream consequences
- Downstream orifices, 178



Drainage, 36, 38, 39, 40, 41, 42, 64, 74, 107, 183, 187, 192, 196, 197, 199, 207, 213, 214, 220, 234, 237, 279, 342, 344  
Drilling, 193, 263, 264  
Durability, 169, 193, 194, 199

## E

Eddies, 4, 8, 17, 37, 38, 63, 64, 65, 84, 101, 159, 190, 191, 231, 232, 272  
Elkhead Creek Dam, 82  
Embankments, 140, 310  
Emergencies, 18, 19, 21, 132, 133, 134, 143, 147, 154, 155, 223, 226, 228, 230, 242, 254, 286, 348  
End sill, 34–35  
Energy dissipator  
    cleaning, 256–260  
    definition, 342  
    unwatering a dissipation structure for inspection, 254–256  
Energy loss, 25, 62, 114, 161, 170, 176–178, 180  
Engineering, 63, 89, 184, 187, 192, 197, 199, 207, 228, 263, 275, 344  
Enid Dam, 273  
Enlargements, *see* Sudden enlargements  
Erosion, 272–274  
Expansion, *see* Conduit outlet or sudden expansion  
Extraction and self-rescue, 289–290

## F

Fabricated slide gates, 145–147, 334  
Facilities, 36, 37, 40, 41, 42, 78, 122, 124, 141, 151, 200, 223, 224, 229, 242, 243, 244, 255, 283, 285, 290  
Factor of safety, 18, 21, 31, 35, 49, 60, 64, 65, 172, 205, 208, 343  
Failures, 192, 195, 198, 199, 205, 254, 255, 276  
Fences, 287  
Filter bedding, 195  
Fixed-cone valve, 109–120, 344  
Fixed-wheel gates, 151, 158–160, 344  
Flip bucket, 88–90  
Floods, 1, 20, 21, 69, 201, 213, 214, 226, 281, 286, 289

## Flow

- butterfly valves for regulating free discharge flow, 132–134
  - conduit outlet expansions (flow transitions), 101–108
  - critical, 1, 23, 342
  - flow deflectors, 44–46
  - jet-flow gates, 109, 134, 135–138
  - subcritical, 1, 9, 15, 23–25, 101, 211, 213, 345, 346
  - supercritical, 1, 23–25, 185, 211, 213, 345, 347
- Flow transitions, *see* Conduit outlet expansions
- Forces, 23, 74, 77, 107, 122, 132, 183, 192, 194, 196, 199, 231, 343, 344, 347
- Foundations, 20, 38, 39, 40, 41, 42, 43, 81, 82, 86, 87, 195, 225, 228, 231, 234, 235, 237, 238, 239, 261, 275, 294, 342, 344, 346
- Free discharge flow, 132–134
- Freeboard, 35, 36, 333
- Freezing and thawing, 42, 265, 268, 274–276, 279
- Friction, 23, 36, 41, 73, 145, 146, 153, 154, 155, 156, 161, 178, 180, 344
- Frost, 9, 36, 38, 108, 198
- Froude number, 9, 12, 15, 18, 23–32, 48–60, 63, 64, 65, 69, 72, 73, 77, 86, 102, 104–106, 183, 187, 190, 191, 205, 211, 258, 342, 343

## G

- Gabions, 199, 200, 343
- Ganado Dam, 77
- Gates, 1, 2, 4, 7, 8, 10, 13, 14, 19, 21, 23, 24, 28, 30, 31, 32, 36, 37, 39–41, 45–47, 49, 52, 53, 57, 58, 60, 63, 81, 86, 93, 104, 107, 109, 120, 128, 131–158, 170, 175, 178–180, 186, 193, 197, 224, 225, 233, 243, 261, 262, 269, 270, 272–274, 279, 283, 287, 292, 342–344, 346, 347
- General categorization of repair approach, 281
- Geotextiles, 15, 40, 195, 196, 197, 199, 200, 201, 203, 204, 207, 208, 209, 210, 235, 341, 344
- placement, 208
- Gradation, 85, 107, 189, 192–194, 197, 212, 214, 219
- Granular bedding, 195–196
- Groundwater, 39, 254, 255
- Grouted riprap, 83, 101, 197–199
- Guadalupe Dam, 205, 206
- Guards, 289
- Guidance, *see* Design guidance

## H

- Handholds and ladders, 289–290
- Head, 4, 9, 12, 16, 18, 25, 47, 52, 60, 72, 82, 87, 91, 93–95, 98, 101, 104, 109, 112, 116, 121, 124, 130, 132, 134, 137–139, 141, 143, 146, 150–154, 156–159, 161, 163–167, 170–176, 178–181, 200, 222, 239, 247, 279, 286, 292, 344, 345, 346
  - high head application, 91–95
  - low head application, 95–101
- Head loss, 13, 91–95, 151, 161, 163, 165–167, 170, 172, 175, 178, 180, 344
- Head loss, pressure, and velocity considerations, 161–167
- HEC-14 design guidance, 184–187
- High pressure gates, 134, 142–145, 259, 343, 344
- Hollow-jet valves, 37, 60–63, 112, 115, 347
- Hooded fixed-cone valves, 84, 113, 116–120
- Hook basin, 77–78
- Horizontal energy dissipators, 124–125
- Hydraulic design rock chart, 191–192
- Hydraulic head, *see* Head
- Hydraulic jump stilling basins, 23–72
- Hydraulic jumps, 1, 3, 8–11, 15, 18, 20, 23–30, 31, 34, 37, 38, 40, 44–49, 52, 55, 57, 59–61, 64, 70, 72, 77, 79, 98, 100–102, 104–107, 140, 144, 147, 154, 156, 199, 211, 231, 238, 258, 272, 341, 342, 345, 346
  - expansion with a hydraulic jump, 101–104
  - Froude number, 24–28
  - length of the hydraulic jump stilling basin, 31
  - selection of a hydraulic jump stilling basin, 46–69
- Hydraulic properties of riprap aprons, 191

## I

- Ice, 36, 78, 112, 113, 151, 198, 235, 236, 287
- Impact basins, 69–80
  - type VI impact basins, 69–77
- Impingement, 83, 84, 87, 114
- Incipient cavitation, 48, 172, 174, 175, 176, 179
- Initial depth, 28–31
- Inline orifice, 163–167, 177–182

- Inspections, 221–260
  - factors influencing scheduling, 224–226
  - performing, 230–239
  - periodic inspections by selected organizations, 226
  - preparing for an inspection, 226–230
  - specialized, 239–260
  - types, 222–224
  - underwater, 267
  - unwatering a dissipation structure for inspection, 254–256
- Installation, 37, 38, 41, 52, 60, 89, 91, 93, 95, 99, 112, 116, 121–123, 130, 132, 134, 140, 143, 145, 147, 150, 152–154, 156, 196, 199, 201, 205, 207–210, 217, 257, 282, 290, 347
- Instruments, 240, 246, 248
- Intervals, 13, 176, 197, 222, 271
- Inverts, 18, 41, 69, 72, 73, 81, 82, 86, 92, 97, 98, 99, 101, 141, 166, 187, 213, 214, 231, 232, 249, 250
- Investigations, 9, 38, 44, 45, 48, 94, 157, 175, 227, 267, 277

## J

- Jet trajectory, 83–84
- Jet-flow gates, 109, 134, 135–138
- Jets entering sudden enlargements, 161–167
- Joint maintenance, 282
- Jump, *see* Hydraulic jump

## K

- Kinetic energy, 1, 86, 159, 343, 345
- Kinzua Dam, 44, 262

## L

- Laboratories, 24, 48, 64, 165, 183, 191, 205, 227, 263, 264, 267, 270, 274, 277
- Laboratory investigations, 267
- Land-based access barriers, 287, 288
- Leakage, 130, 132, 138, 139, 143, 144, 147, 153, 243, 257, 344

Length, 18, 23, 27, 31, 34, 41–44, 46, 48, 52, 55, 57, 59–65, 81, 87, 104, 106, 130, 157, 159, 161, 169, 177, 181, 183–187, 189–191, 193, 208, 211, 213, 215, 246, 250, 291, 293, 341, 343  
    length of the hydraulic jump stilling basin, 31  
Life preservers, 290  
Lights, 25, 30, 38, 59, 73, 77, 95, 109, 124, 126, 130, 145, 171, 181, 192, 229, 235, 246, 249, 272, 286, 341, 342, 345, 347  
Lockout/tagout, 224, 229, 230  
Low head application, 95–101  
Lucky Peak Dam, 81

## M

Maintenance, 3, 8, 23, 38, 42, 45, 112, 124, 126, 132, 140, 143, 153, 156–158, 199, 220, 223, 227, 229, 245, 251, 261–282, 287, 290, 293  
    joint maintenance, 282  
Maintenance and repair, 261–282  
Manufacture, 114, 116, 117, 123, 124, 126, 128, 137, 148, 155, 195, 201, 206, 207, 208, 261, 294, 343  
Marshes, 289  
Maryland design guidance, 184  
Mason Dam, 33, 45, 272  
Materials, 8, 18, 20, 23, 35, 39–45, 63, 78, 81, 84–87, 106–108, 145, 169, 183, 186, 189, 192–197, 201–207, 210, 225, 227, 231–233, 235–239, 241, 250, 255, 258, 261–264, 271–273, 275, 277, 279–282, 287, 291–294, 341–346  
    corrosion of embedded materials, 271–272  
    for ACB systems, 206–207  
    properties of repair materials, 277–279  
    repair materials, 281  
Matrices, 15, 200, 270, 274, 294  
Methods of repair, 277–281  
Mica Dam, 167  
Mixtures, 192, 193, 203, 280  
Modes, 19, 20, 21, 112, 232, 248, 261  
Modifications, 40, 41, 99, 134, 222, 272  
Monovar valves, *see* Multi-ported sleeve valves  
Movement of structures, 41, 151, 154, 189, 191, 195, 196, 199, 225, 235, 237, 247, 263, 264, 266, 268, 271, 275, 276, 343, 347  
Multiple orifice valve, 128–132  
Multi-ported sleeve valves, 122–130  
    horizontal energy dissipators, 124–125  
    vertical stilling well energy dissipators, 125–127

## N

Navajo Dam, 37, 63  
Nets, 290  
New York design guidance, 184  
Nilan North Dam, 104  
Noise, 24, 124, 125, 169, 170, 171, 172, 175, 176, 177, 253, 293, 347  
Nondestructive testing, 267  
Norman Dam, 256

## O

Obstructions, 24, 41, 132, 170, 236, 239, 248, 250  
Operations, 31, 38, 39, 44, 45, 46, 82, 178, 224, 226, 229, 230, 239, 242, 262, 281, 284  
Operators, 61, 130, 132, 134, 171, 224, 246, 247, 248, 249, 250, 251, 253, 281, 290, 291, 345  
Orientation, 45, 69, 246, 276, 279  
Orifices  
    considerations for downstream orifices or sudden enlargements, 178  
    design guidance for sudden enlargements and inline orifices, 178–182  
    distance between series of inline orifices, 177  
    energy loss computations for sudden expansion and inline orifices, 177–178  
    inline orifice, 163–167, 177–182  
    multiple orifice valve, 128–132  
    sudden enlargements with jet contraction (inline orifices), 163–167  
    type of enlargements and orifices and effects on energy dissipation, 167–170  
Outlet, *see* Conduit outlet  
Overtopping, 43, 53, 74

## P

Palisades Dam, 44  
Palm Tree Creek outlet, 93  
Parameters, 81, 82, 85, 87, 104, 105, 161, 171, 172, 176, 179, 183, 188, 189, 191, 273  
Patterns, 10, 44, 60, 110, 128, 151, 160, 167, 232, 258, 259, 265, 268, 269, 270, 276, 343, 347  
Penetration, 36, 197, 210, 246  
Periodic inspections, 222, 226, 272  
Personnel, 19, 222, 223, 225, 228, 229, 243, 244, 252, 261, 281, 290, 293  
Pineview Dam, 169



Pipelines, 121, 122, 130, 161, 164, 169, 172, 245  
Pitting, 24, 170, 172, 235, 337  
Placement of ACB, 208–210  
Plunge basins, 81–90  
    design, 85–88  
    scour process, 84–85  
    types, 82–83  
Pomme de Terre Dam, 273  
Pomona Dam, 44, 262, 273  
Potential energy, 1, 177, 211, 243, 345  
Powerplants, 46, 60, 154, 158  
Preparation, 208  
    concrete removal and preparation for repair, 281  
    subgrade, 208  
Pressure-reducing valves, 122, 131  
Preventing access, 283, 287–289  
Preventive measures, 274, 292–294  
Properties of repair materials, 277–279  
Properties, hydraulic, 191  
Protection against vandalism, 290–294  
Public safety, 3, 283–294

## R

Radial gate, *see* Top-seal radial gate  
Ratios, 28, 30, 55, 56, 57, 58, 76, 87, 93, 95, 96, 97, 164, 166, 170, 173, 175, 176, 177, 179, 180, 186, 190, 191, 195, 245, 343  
Reclamation stilling basins, 48–63  
    type I, 49  
    type II, 49  
    type III, 49–52  
    type IV, 52–55  
    type V, 55–60  
    type VIII, 60–63  
Rehabilitation, 244, 255, 261, 262, 263, 271, 277, 281  
Reinforcement, 231, 232, 233, 235, 236, 240, 246, 249, 264, 344  
Remotely operated vehicle, 1, 3, 8–13, 15, 19, 23, 27, 30, 31–38, 40–44, 48, 52, 61, 69, 69, 73, 76, 79, 84, 86–89, 91, 96, 99, 101, 103, 107–110, 114, 116, 121, 124–126, 134, 138, 141, 143, 145, 148, 154, 157, 164, 170, 174, 181, 183, 186, 189, 192, 195–199, 201, 203, 207–211, 217, 222, 224–226, 228–230, 233, 239, 243–249, 252–256, 262, 267, 273, 277, 280–283, 285–288, 294, 341, 343, 345

- Repair, 261–282  
     concrete removal and preparation for repair, 281  
     design of concrete repairs, 277–281  
     general categorization of repair approach, 281  
     methods, 277–281  
     properties of repair materials, 277–279  
     repairs material database, 280–281  
     underwater, 281
- Reservoirs, 1, 16, 18, 19, 20, 40, 46, 63, 85, 87, 98, 144, 192, 223, 224, 227, 228, 230, 231, 282
- Resistance, 36, 169, 193, 194, 196, 254, 270, 280
- Review of engineering data, 263
- Riprap, 183–189  
     grouted, 197–199  
     riprap and concrete blocks, 183–210  
     aprons, 183–187  
     basins, 187–189  
     transitional riprap aprons downstream of energy dissipators, 189–192  
     transitional riprap design below SAF stilling basins, 190–191
- Risk, 19–21, 77, 172, 205, 243, 248, 261, 267, 283, 346, 347
- Risk and downstream consequences, 19–22
- Rock, 5, 8, 14, 17, 23, 38, 40, 42, 44, 74, 85, 87, 94, 97, 99, 183, 186, 188, 191–194, 197–199, 214, 225, 231, 236, 240–242, 255, 258, 261, 268, 272, 283, 290–294, 341, 342, 344  
     hydraulic design rock chart, 191–192  
     wire-enclosed rock or gabions, 199
- Rock throwing, 290–292
- ROV, *see* Remotely operated vehicle

## S

- SAF stilling basins, 1, 3, 8, 18, 20, 24, 30, 31, 35, 49, 60, 64–72, 88, 97, 112, 157, 169, 172, 190, 205, 208, 221–226, 229, 242–244, 247, 250, 252, 281, 283–287, 290, 341, 343, 348
- Safety, 3, 8, 18, 20, 30, 31, 35, 49, 60, 64, 88, 97, 112, 172, 205, 208, 221–226, 229, 242–244, 247, 250, 281, 283–294, 341, 343, 348  
     factor of safety, 18, 21, 31, 35, 49, 60, 64, 65, 172, 205, 208, 343  
     public safety and vandalism protection, 283–294
- Samples, 207, 246, 264, 267
- Sand, 17, 40, 42, 44, 87, 195, 199, 203, 208, 225, 231, 238, 256, 258, 269, 272, 274
- Scheduling of inspections, 224–226

## Outlet Works Energy Dissipators

---

- Scour, 4, 10, 17, 19, 23, 28, 34, 38, 60, 63, 69–71, 74, 77, 81, 84–87, 102, 106, 186, 189–191, 195, 210, 214, 219, 283, 286, 288, 290, 293, 343, 345, 346
  - plunge basin scour process, 84–85
- Sealing compounds, 282
- Seepage, 19, 21, 38, 39, 42, 43, 108, 196, 198, 238, 254, 261, 264, 266, 276, 342, 347, 348
- Selection, 7, 13, 41, 46–69, 100, 109, 196, 226, 262, 267, 277, 279, 282
  - material selection, 280
  - selection of a hydraulic jump stilling basin, 46–69
  - valve and gate selection and energy dissipation requirements, 109–156
- Sequent depth, 28–31
- Series of inline orifices, 177
- Service conditions, 279–280
  - material selection, 280
  - repairs material database, 280–281
- Settlement and movement, 275
- Seven Oaks Dam, 81, 88, 159, 169, 173, 177, 179
- Shape, 30, 38, 52, 60, 61, 73, 81, 82, 83, 85, 86, 87, 102, 110, 127, 170, 175, 184, 192, 193, 199, 201, 211, 240, 252, 282, 345
- Shrinkage, 234, 268, 275, 276, 277
- Side walls, 31, 34, 35–38, 38, 45, 62, 74, 214, 346, 348
- Signs, 9, 17, 24, 40, 46, 48, 81, 116, 120, 126, 133, 157, 184, 191, 220, 228, 284–287
- Sleeve valves, 11, 12, 91–94, 120–130, 170, 346, 347
  - bottom discharge sleeve valves, 127–128
- Slide gates, 13, 109, 134, 138–147, 151, 154, 178, 343, 344
  - bonneted, 13, 109, 138, 140–142, 343
  - cast-iron (unbonneted), 141–145
  - fabricated, 145–147
  - high pressure, 138–141
- Slope changes, 289
- Soil, 15, 23, 36, 38, 39, 40, 42, 53, 77, 81, 84, 85, 86, 87, 195–210, 234, 238, 254, 261, 294, 341, 342, 343, 344, 346
- Sonar, 247, 251–254
- Soundings, 231, 251, 252, 286
- Spalling, 231, 235, 263, 264, 266, 269, 270, 271, 272, 275, 276, 281
- Specialized inspection, 239–260
  - climbing team, 244–245
  - dive team, 239–244
- Splashing, 74, 76
- Splitter walls, 35, 37, 38, 45, 346
- Spray, 7, 12, 25, 35, 76, 78, 110, 112, 113, 115, 116, 125, 137, 151, 214, 259, 274
- Stability, 17, 21, 42, 190, 195, 205, 206, 207, 210, 263, 267
- Standard baffle basin, 78–79

- Standards, 186, 207, 225, 228–230, 242, 285, 287  
    AASHTO, xxxix  
    ASTM, xl
- Standley Lake Dam, 82
- Steel, 12, 17, 36, 45, 77, 92, 93, 94, 114, 138, 141, 143, 145, 146, 154, 169, 172, 179, 201, 202, 232, 234, 235, 240, 246, 249, 250, 251, 265, 271, 273, 274, 281, 291, 293, 344
- Stilling basin, *see also* Hydraulic jump, Reclamation, USACE, or SAF stilling basin  
    expansion to a stilling basin, 104  
    length of the hydraulic jump stilling basin, 31  
    other stilling basin features, 35–46  
    selection of a hydraulic jump stilling basin, 46–69  
    appurtenances, 31–35  
    transitional riprap design below SAF stilling basins, 190–191
- Stilling wells, 91–100  
    vertical stilling well energy dissipators for multi-ported sleeve valves, 125–127  
    vertical stilling wells energy dissipator for bottom discharge sleeve valves, 127–128
- Stoplogs, 35, 37, 38, 39, 222, 256, 257
- Streambed-level basins, 77–82
- Stresses, 134, 205, 231, 234, 269, 277, 279
- Structure underdrains, 38–44
- Subcritical flow, 1, 9, 15, 23–25, 101, 211, 213, 345, 346
- Subgrade preparation, 208
- Sudden enlargements, 157–182  
    considerations, 178  
    design guidance, 178–182  
    dimension and velocity of jet entering sudden enlargement, 161–162  
    energy loss computations for sudden expansion and inline orifices, 177–178  
    with jet contraction (inline orifices), 163–167  
    without jet contraction, 162–163
- Sulfates, 199, 268, 269, 270, 280
- Supercritical flow, 1, 23–25, 185, 211, 213, 345, 347
- Surface coatings, 282
- Surveys, 227, 231, 247, 262–267
- Swimming, 125, 283, 284, 288
- Symbols, xxxv
- Symptoms of distress/deterioration of concrete, 261, 262, 264, 274

### T

- Tailwater, definition, 346
- Tailwater depth, 28–31
- Television, *see* Closed circuit television
- Temperature, 9, 175, 240, 243, 246, 247, 268, 275, 276, 279, 280
- Testing, 9, 63, 116, 143, 144, 153, 191, 193, 194, 205, 207, 240, 247, 263, 264, 267, 293
  - nondestructive, 267
  - performance, 205
- Tilt, 40
- Top seal radial gates, 151, 153, 344
- Training, 221, 229, 242, 248, 287, 346
- Training walls, *see* Side walls
- Trajectories, 8, 30, 61, 83, 84, 85
- Transitional riprap aprons downstream of energy dissipators, 189–192
- Transitional riprap design below SAF stilling basins, 190–191
- Trenches, 42, 209, 210
- Tunnels, 5, 7, 109, 157, 167, 175, 176, 179
- Type I stilling basins, 49
- Type II stilling basins, 49
- Type III stilling basins, 49–52
- Type IV stilling basins, 52–55
- Type V stilling basins, 55–60
- Type VI impact basins, 69–77
- Type VIII stilling basin, 60–63
- Tullis method of cavitation analysis, 173–175
- Twin Lakes Dam, 42, 139, 250

### U

- Unbonneted gates, *see* Cast-iron slide gate (unbonneted)
- Underdrains, 33, 35, 38–43, 222, 237, 248, 250, 254–256, 259, 347
- Underwater, 44, 230, 231, 239, 242, 243, 245, 247, 249, 252, 253, 262, 267, 281, 283, 345
- Underwater inspection, 267
- Underwater repairs, 281
- Unwatering, 9, 35, 37, 38, 44, 124, 126, 222, 224, 230, 247, 251, 254–257, 347
- USACE stilling basin, 63–64

---

## V

Vapor, 48, 159, 164, 165, 170, 171, 172, 173, 175, 180, 342

### Valves

bottom discharge sleeve, 127–128

butterfly, 132–134

butterfly valves for guard valve, 134

fixed-cone, 109–120, 344

fixed-cone valve discharging into horizontal energy dissipation chambers, 114–116

hollow-jet, 37, 60–63, 112, 115, 347

hooded fixed-cone, 116–120

multiple orifice, 128–132

multi-ported sleeve, 122–130

sleeve, 11, 12, 91–94, 120–130, 170, 346, 347

valve and gate selection and energy dissipation requirements, 109–156

Vandalism protection, 3, 197, 199, 231, 272, 283, 290–294

Vegetation, 195, 201, 210, 236, 286–

Vehicles, 40, 230, 239, 245, 246, 247, 249, 250, 286, 342, 345

Velocity, 1, 4, 8–10, 15, 18, 23–25, 27, 30, 31, 34–36, 45, 47–49, 64, 69, 69, 72–74, 76, 83–85, 88, 91, 104, 106, 132–134, 157, 159, 161–163, 165, 167, 170, 177, 186–188, 190–192, 205–207, 211, 213, 217, 220, 231, 235, 240, 272, 286, 341, 342, 345, 346

critical, 1, 9, 23, 213, 214, 217, 342

dimension and velocity of jet entering sudden enlargement, 161–162

head loss, pressure, and velocity considerations, 161–167

Vena contracta, 163

### Vertical stilling well energy dissipators

for bottom discharge sleeve valves, 127–128

for multi-ported sleeve valves, 125–127

Vibration, 4, 9, 17, 18, 24, 37, 74, 95, 113, 144, 151, 153, 154, 155, 169, 172, 173, 176, 177, 271, 293

Video, 244

Virginia Smith Dam, 39, 43, 240, 291

Visibility, 240, 244, 246, 251



## W

Walls, 8, 10, 17, 23, 25, 28, 31, 34–40, 45, 47, 61–63, 69, 74, 83, 91, 93, 107, 114, 120, 140, 151, 170, 172, 189, 197, 211, 213–215, 217, 219, 231, 234, 237–239, 245, 256, 261, 266, 269, 274, 287–289, 292, 342, 343, 346, 348  
side walls, 31, 34, 35, 36, 38, 38, 45, 62, 74, 214, 346, 348  
splitter walls, 35, 37, 45, 346  
training walls, *see* Side walls  
wing walls, 35, 38, 69, 107, 348

Warnings, 284, 285, 286

Weathering, 5, 193, 194, 231, 265, 268, 275, 282

Websites, xli

Weep holes, 8, 18, 20, 30, 31, 41–43, 49, 53, 61, 65, 199, 231, 237, 341, 348

Weight, 134, 146, 151, 154, 161, 164, 188, 191, 192, 202, 205, 206, 207, 254, 255, 292

Wells, *see* Stilling wells

Wing walls, 35, 38, 38, 69, 107, 348

Wire-enclosed rock or gabions, 199

## X-Z

Xiaolangdi Dam, 169

Zones, 49, 286

## Glossary

The terms defined in this glossary use industry-accepted definitions whenever possible. The source of the definition is indicated in parentheses. A few of these industry-accepted definitions have been slightly modified to better fit within the context of this manual.

**Abrasion erosion:** Damage caused by the action of gravel, rocks, and other debris rolling and grinding against a concrete surface. The sources of these materials include construction trash left in a structure, rock or riprap brought back into a basin by eddy currents because of poor hydraulic design or asymmetrical discharge, and rock or riprap or other debris thrown into a basin by the public. Abrasion erosion is readily recognized from the smooth, worn-appearing concrete surface. The damaging material will also have a smooth appearance.

**Appurtenance:** Ancillary features in a stilling basin such as chute blocks, baffle blocks, and end sills. These features are used to increase turbulence and produce a stabilizing effect on the hydraulic jump which reduces the required length of the basin and provides a factor of safety against sweepout caused by inadequate tailwater depth.

**Apron:** A section of concrete or riprap constructed upstream or downstream from a control structure to prevent undercutting of the structure.

**Articulated concrete block (ACB):** A concrete block unit when installed and interconnected with other block units forms an erosion resistant revetment with specific hydraulic characteristics. The individual units are connected by geometric interlock, cables, ropes, geotextiles, geogrids, or a combination thereof, and typically overlay a geotextile for subsoil retention.

**Baffle block (baffle pier):** One of a series of upright obstructions placed in intermediate positions across a floor designed to create turbulence and dissipate energy as in the case of a stilling basin or drop structure. A block, usually of concrete, constructed in a channel or stilling basin to dissipate the energy of water flowing at high velocity.

**Baffled drop:** A hydraulic structure used to pass water to a lower elevation while controlling the energy and velocity of the water as it passes over.

**Bedding:** A material used for support purposes.

**Camera-crawler (FEMA, 2005):** A video camera attached to a self-propelled transport vehicle (crawler). Typically, the camera-crawler is used for closed circuit television inspection of inaccessible conduits and drain pipes.

**Cavitation (ACI, 2000):** Pitting of a material caused by implosion, that is, the collapse of vapor bubbles in flowing water that form in areas of low pressure and collapse as they enter areas of higher pressure.

**Chute block:** One of a series of upright obstructions placed at the upstream entrance to a stilling basin to increase the effective depth of the incoming flow, break the flow up into a number of small jets, and help create turbulence for energy dissipation.

**Closed circuit television (CCTV) (FEMA, 2005):** A method of inspection utilizing a closed circuit television camera system and appropriate transport and lighting equipment to view the interior surface of conduits and drainpipes.

**Conduit (FEMA, 2004):** A closed channel to convey water through, around, or under a dam.

**Conduit outlet expansion:** A relatively low cost energy dissipation structure that is designed to contain the hydraulic jump within the confines of a flared transition structure between the outlet conduit and the downstream channel.

**Conjugate depth:** The depth of flow after the occurrence of a hydraulic jump. The conjugate depth is dependent on the specific energy available at the entrance of the stilling basin (Froude number) and the initial depth of flow. The conjugate depth is also called the sequent depth.

**Critical flow:** The flow is critical when the Froude number of the flow is equal to one.

**Critical velocity:** The mean velocity when the flow is critical.

**Cutoff wall:** A concrete wall located in the foundation beneath an energy dissipator and used to form a water barrier and reduce seepage under the structure.

**Dewatering:** The removal and control of ground water from pores or other open spaces in soil or rock formations to the extent that allows construction activities to proceed as intended, including the relief of ground water pressure. Removing water by pumping, drainage, or evaporation. The removal of ground water and seepage from below the surface of the ground or other surfaces through the use of deep wells and well points.

**Discharge:** The amount of water flowing through a hydraulic structure or channel.

**End sill:** An upright obstruction usually located at the downstream end of a stilling basin. The end sill can be solid or dentated and is used to reduce the length of the stilling basin by creating additional tailwater depth and to provide for scour control.

**Energy dissipator:** A device constructed in a waterway to reduce the kinetic energy of fast flowing water.

**Erosion:** The progressive wearing away of a surface.

**Factor of safety:** The fraction of structural capability over that required, or a multiplier applied to the maximum expected load (force, torque, bending moment or a combination) to which a component or assembly will be subjected. The two senses of the term are completely different in that the first is a measure of the reliability of a particular design, while the second is a requirement imposed by law, standard, specification, contract or custom.

**Filter fabric:** A porous cloth-like material used to prevent movement of fine soil particles.

**Flow deflector:** A device placed across the downstream portion of a stilling basin to change the flow pattern with the basin. A flow deflector is used to reduce or eliminate abrasion erosion damage caused by waterborne materials and debris within the stilling basin.

**Freeboard:** The vertical difference in elevation between a water surface and top of wall or dam.

**Froude number:** A dimensionless number representing the ratio of inertia forces and gravity forces acting upon water and making it possible to distinguish between sub-critical and super-critical flow.

**Gabion:** A wire basket, filled with stones, used to stabilize banks of a water course.

**Gate:**

**Bonneted slide gate:** Essentially a completely enclosed slide gate used for regulating flow that is manufactured and designed to be embedded (except for the actuator) in concrete.

**Clam shell gate:** High pressure regulating gate consisting of two curved leaves which open and close over the end of a conduit. Used for free discharge into air with minimal cavitation damage.

**Fabricated slide gate:** A gate similar in appearance and operation to the cast-iron slide gate, but the construction is quite different. Fabricated slide gates can be made from carbon steel, stainless steel, aluminum, or composite.

**Fixed-wheel gate:** A gate consisting of a rectangular leaf mounted on wheels, particularly suited for high head situations. A gate having wheels or rollers mounted on the end posts of the gate. The wheels bear against rails in side grooves or gate guides.

**High pressure gate:** A gate consisting of a rectangular leaf encased in a body and bonnet and equipped with a hydraulic hoist for moving the gate leaf.

**Jet-flow gate:** A gate consisting of a wheel-mounted leaf moved vertically by a motor-driven screw hoist. High pressure gate resembling a ring follower gate in general configuration, but designed for regulating flow with minimal cavitation damage.

**Slide gate:** A gate that can be opened or closed by sliding in supporting guides. With seating or face pressure, water exerts a force on the front of the gate. The pressure of the water forces the gate slide against the frame. Unseating or back pressure is encountered when the depth of water is greater on the back side of the gate. Under these conditions, the fluid force pushes the slide away from the frame and the total force must be resisted by the wedging devices and assembly bolts of the gate. Therefore, gates are designed for considerably less back pressure than they are for face pressure. The possibility of leakage increases with the fluid pushing the slide away from its seating surfaces.

**Top seal radial gate:** A pivoted crest gate, the face of which is usually a circular arc, with the center of curvature at the pivot about which the gate swings. The gate has a curved upstream plate and radial arms hinged to piers or other supporting structure. Pressure is transferred from the curved face through the horizontal support beams to the radial arms at the sides of the opening. The arms act as columns and transfer thrust to a common bearing located on either side of the gate opening. The top of the gate has a seal to prevent overflow.

**Geotextile (FEMA, 2004):** Any fabric or textile (natural or synthetic) when used as an engineering material in conjunction with soil, foundations, or rock. Geotextiles have the following uses: drainage, filtration, separation of materials, reinforcement, moisture barriers, and erosion protection.

**Head loss:** The energy lost from a flowing fluid due to friction, transitions, bends, etc.

**Hook (Aero) basin:** An energy dissipating structure that utilizes hook shaped obstructions to reverse and turn the momentum of flow upon the surrounding flow to slow the overall velocity.

**Hydraulic head:** The difference between the respective elevations of the upstream water surface (headwater) above and the downstream surface water (tailwater).

**Hydraulic jump:** The abrupt rise in a water surface when flow at high velocity (supercritical) discharges into a zone of lower velocity (subcritical). The hydraulic jump is a commonly used method of energy dissipation.

**Impact basin:** An energy dissipating structure that utilizes a positive barrier (baffle) within the flow area. Energy dissipation is accomplished by the turbulence created by the loss of momentum as the flow impacts the barrier and the direction of flow is changed.

**Inline orifice:** An energy dissipating device (plate or structure) installed within a pressurized flow conduit. The orifice opening (normally circular) will be smaller in area (or diameter) than the main conduit, thereby forcing a contraction and acceleration of the flow past the orifice. Downstream of the orifice, the flow experiences a sudden expansion where most of the energy drop at the orifice is dissipated through the intense eddy action brought about by the viscous shear caused by the high velocity orifice jet. Inline orifices can be normal sharp crested, rounded, or tapered for different energy dissipation rates. Inline orifices are often placed in series, spaced apart to optimize energy dissipation, to incrementally step down the pressure drop and to avoid dangerous cavitation levels.

**Kinetic energy:** The energy of a body with respect to the motion of the body.

**Plunge basin:** A deep pool into which a free jet of water discharges for the purpose of kinetic energy dissipation before being returned to the downstream channel.

**Potential energy:** The energy of a body with respect to the position of the body.

**Remotely operated vehicle (ROV) (FEMA, 2005):** An unoccupied, highly maneuverable underwater robot controlled by a remote operator usually located in a ship or on the shore. Most vehicles are equipped with a video camera and lights. Additional equipment can be added to expand the vehicle's capabilities.

**Riprap (FEMA, 2004):** A layer of large uncoursed stone, precast blocks, bags of cement, or other suitable material, generally placed on the slope of an embankment or along a watercourse as protection against wave action, erosion, or scour. Riprap is usually placed by dumping or other mechanical methods, and in some cases is hand



placed. Riprap consists of pieces of relatively large size, as distinguished from a gravel blanket.

**Risk:** The relationship between the consequences resulting from an adverse event and its probability of occurrence. The ability to describe potential outcomes using historic probability. The likelihood or chance of an unacceptable event occurring.

**Scour (FEMA, 2005):** The loss of material occurring at an erosional surface, where a concentrated flow is located, such as a crack through a dam or the dam/foundation contact. Continued flow causes the erosion to progress, creating a larger and larger eroded area.

**Side walls (training walls):** Walls running parallel to the flow in a stilling basin with the purpose of containing a hydraulic jump.

**Stilling basin (FEMA, 2004):** A basin constructed to dissipate the energy of rapidly flowing water and to protect the riverbed from erosion.

**Stilling well:** An energy dissipation structure where the incoming flow can be directed vertically downward into the bottom of the well or horizontally into the well. The energy dissipation is achieved by the expansion in the enlarged stilling well, the impact of the fluid on the base and walls in the stilling well, and the change in momentum resulting from redirection of flow. The flow rises up and emerges from the top of the well, which is often flush with the outlet channel. Stilling wells often utilize fixed-cone and sleeve valves.

**Splitter wall:** A wall parallel to the direction of flow in a chute or stilling basin that separates flows released from different sources as a means of energy dissipation.

**Subcritical flow:** Those conditions of flow for which the depths are greater than critical and the velocities are less than critical.

**Subgrade:** Soil prepared and compacted to support a structure.

**Sudden enlargement:** A form of areal or diameter enlargement within a pressurized conduit used for energy dissipation. Examples include (a) abrupt expansion in pipe diameter or conduit dimension in the downstream flow direction, (b) flow through a gate into a larger pressurized conduit, (c) sharp crested, rounded, or tapered inline orifices, and (d) conduits with gradual contraction reducers followed by abrupt expansions. Energy is dissipated through the intense eddy action brought about by the viscous shear caused by the higher velocity jet entering the larger conduit. Sudden enlargements are often placed in series to incrementally step down the pressure drop and to avoid dangerous cavitation levels.

**Supercritical flow:** Those conditions of flow for which the depths are less than critical and the velocities are greater than critical.

**Tailwater:** The water in the natural stream immediately downstream from an energy dissipator. The elevation of water varies with discharge from the outlet works.

**Underdrain:** A system of inter-connected pipes beneath a stilling basin used to relieve hydrostatic pressures which could result in uplift forces.

**Unwatering:** The interception and removal of ground water outside of excavations and the removal of ponded or flowing surface water from within excavations. To remove or drain off water. The removal and control of ponded or flowing surface water, surface seepage, and precipitation from within and adjacent to excavations by the use of channels, ditches, and sumps.

**Valve:**

**Butterfly valve:** A valve designed for quick closure that consists of a circular leaf, slightly convex in form, mounted on a transverse shaft carried by two bearings.

**Fixed-cone valve:** A cylinder gate mounted with the axis horizontal.

**Hollow-jet valve:** A valve having a closing member that moves upstream to shut off the flow. The hollow-jet valve discharges a hollow or annular jet dispersed over a wide area.

**Multiple orifice valve:** A valve with sliding plates tapped with holes which allows flow or pressure controls without risk of cavitation and with a limited noise. The multiple orifice valve can be installed in-line (for flow or pressure control) or as a free discharged valve (discharge at the atmosphere). The valve is very compact and allows installation in very limited space locations.

**Sleeve valve:** A valve designed to incorporate multiple tapered nozzles on the sleeve for controlling flow and reducing pressure. The sleeve valve is designed to operate throughout its flow range without experiencing damaging cavitation for the conditions specified. The nozzles are arranged in a pattern which effectively directs the water streams to collide at the center of the downstream discharge pipe. The sleeve valve is capable of regulating flow by the linear movement of the sleeve which exposes the required amount of nozzles to achieve the correct flow rate. The sleeve valve is capable of dissipating energy enabling them to be opened against high differential head without damaging the seals.

**Weep hole:** A drain embedded in a structure intended to relieve pressure caused by seepage behind it.

**Wing wall:** A wall that guides water away from the stilling basin side walls to prevent them from being undermined.

### References for Glossary

American Concrete Institute, *Cement and Concrete Terminology*, Committee Report, 2000.

Federal Emergency Management Agency, *Federal Guidelines for Dam Safety: Glossary of Terms*, 2004.

Federal Emergency Management Agency, *Technical Manual: Conduits through Embankment Dams*, FEMA 484, 2005.

# Appendix

## Case Histories

### Index

Feature	Location	Topic	Page A-
Agate Dam	Oregon	Difficulties experienced with a sleeve valve and vertical stilling well	1
Arkabutla Dam	Mississippi	Abrasion erosion damage to a stilling basin	7
Clark Canyon Dam	Montana	Underwater dive inspection of a type II stilling basin	12
Enid Dam	Mississippi	Abrasion erosion damage to stilling basin	17
Elkhead Creek Dam	Colorado	Fixed-cone valve and concrete lined plunge pool	23
Ganado Dam	Arizona	Design and construction of a type VI stilling basin	30
Guadalupe Flood Control Project	California	Displacement of articulated concrete blocks	35
Kinzua Dam	Pennsylvania	Stilling basin experiences abrasion erosion damage and the subsequent repairs	41
Lucky Peak Dam	Idaho	Problems with flip bucket operation	53
Mason Dam	Oregon	Stilling basin flow deflector	58
Mica Dam	Canada	Sudden enlargement	68
Navajo Dam	New Mexico	Abrasion erosion damage at a hollow-jet stilling basin	70
Nilan North Dam	Montana	Replacement of a flared transition type energy dissipator	76

Feature	Location	Topic	Page A-
Norman Dam	Oklahoma	Slope slumping develops after unwatering of a stilling basin	80
Palisades Dam	Idaho	Abrasion erosion damage to a stilling basin	87
Palm Tree Creek Outlet	Australia	Performance of high head vertical stilling well using a ported sleeve valve	93
Pineview Dam	Utah	Inline orifices in a steel bypass pipe	96
Pomme de Terre Dam	Missouri	Abrasion erosion in a stilling basin	98
Pomona Dam	Kansas	Abrasion erosion damage in a stilling basin	103
Seven Oaks Dam	California	Design of a plunge basin	108
Seven Oaks Dam	California	Inline orifices	113
Standley Lake Dam	Colorado	Design and construction of a lined plunge basin	124
Twin Lakes Dam	Colorado	CCTV inspection of a stilling basin underdrain system	132
Virginia Smith Dam	Nebraska	Dive inspection reveals stilling basin damage and requires repairs to be performed	145
Virginia Smith Dam	Nebraska	Detection of internal erosion beneath a stilling basin and the subsequent repairs	153
Xiaolangdi Dam	China	Inline orifices	162

**Project:** Agate Dam

**Location:** Oregon

**Summary:** Difficulties experienced with a sleeve valve and vertical stilling well

Agate Dam is a zoned earth and rockfill embankment located on Dry Creek about 13 miles northeast of Medford, Oregon. The dam was constructed between 1965 and 1966. The dam is basically an offstream facility depending on inflow to the reservoir from diverted sources. Water released from reservoir supplies irrigation water and provides recreational opportunities.

Agate Dam has a structural height of 86 feet and a hydraulic height of 64 feet. The dam crest is 25 feet wide and 3,800 feet long at elevation 1520.0 feet. The reservoir has an active conservation storage capacity of 4,670 acre-feet at reservoir water surface elevation 1510.0.

The spillway is located through bedrock in the left abutment, and consists of an uncontrolled bathtub-shaped inlet with an ogee-shaped concrete crest structure, a concrete-lined chute, and a stilling basin. The stilling basin also accommodates discharges from the outlet works. The ogee crest is approximately 122 feet long at elevation 1510.00 and discharges onto the bathtub floor. The stilling basin is 64 feet long and has dentates at its downstream end. The discharge capacity of the spillway is 3,530 ft<sup>3</sup>/s at maximum reservoir water surface elevation 1514.0.

The outlet works is located through the left abutment bedrock, 228 feet to the right of the spillway. Releases are made through either the main outlet works cut-and-cover concrete conduit or the bypass pipe. The main outlet works consists of a trashracked concrete intake structure (sill elevation 1465.00) with bulkhead slots; a 136-foot long upstream reinforced concrete conduit lined with a 27-inch inside-diameter steel pipe (upstream end invert elevation 1461.50) and 6-inch diameter steel bypass pipe cast within the concrete conduit about 13 inches under the invert of the 27-inch diameter steel lined pipe; a gate chamber; a 6.5-foot diameter, 252-foot long horseshoe-shaped downstream tunnel which houses the 27-inch steel discharge pipe; and a regulating valve control house/stilling chamber at the downstream end. The outlet works utilizes the spillway basin for discharge release ([figure A-1](#)).

The emergency gate chamber houses a manually operated 6-inch gate valve, a 2-inch diameter steel filling pipe with a gate valve installed upstream from the 6-inch gate valve between the 6-inch bypass pipe and the 27-inch main conduit and a manually operated 24-inch gate valve (emergency gate for the 27-inch diameter pipeline). The downstream conduit continues for 252 feet to its termination at the regulating valve





Figure A-1.—Combined spillway and outlet works basin. The sleeve valve is located in the control house on the right side of the basin.

control structure. The 27-inch diameter main pressure pipe transitions to a vertical 24-inch diameter sleeve valve that discharges into a stilling well beneath the control structure. The stilling well is constructed integrally with the control structure for dissipating the energy of water released from the sleeve valve. The sleeve valve is designed for a maximum internal hydraulic pressure of 110 feet, but in this installation operates under a static head of 88 feet.

The sleeve valve consists of a seat, sleeve, guide, pipe connector, and a control stand. The control stand is mounted on top of the connector at the floor level in the control structure (figure A-2). The regulating element of the valve is a moveable sleeve that slides vertically in the guide and seals on the valve seat. Regulation is accomplished by moving the sleeve up or down, thus varying the water passage area between the sleeve and the cone. The valve is controlled by a handwheel hoist in the control stand (figure A-3). The hoist is connected to the sleeve by a hollow stainless steel stem and has a maximum travel of 10.5 inches. Water from the discharge pipe flows through the connector over a truncated distributor cone centered on the valve seat and spreads outward from radially outward from under the sleeve (figure A-4). The estimated weight of the sleeve valve, including the control stand, hoist, base, and supports is about 7,650 pounds. The water rises in the stilling well on the outside of the connector and flows out over a short flume in the side of the stilling well through an opening in the right spillway stilling basin wall into the spillway stilling basin (figure A-5). The discharge capacity of the outlet works is 78 ft<sup>3</sup>/s at reservoir water surface elevation 1510.0.



Figure A-2.—Control stand.

Shortly after completion of construction, the valve became difficult to open and close. Relatively fine abrasive material (sand) in small amounts was found on the upper stem and gland. This sand appeared to have been left over from some earlier sand blasting during construction. The sand was removed by wiping and vacuuming and the stem was relubricated. Additional problems were experienced with operation of the sleeve valve due to algae buildup, necessitating cleaning several times a year. The algae buildup required the use of excessive force on the handwheel. Eventually, the original V-type packing was replaced with a new self-lubricating type packing and the operating difficulties were corrected.

In 1969, the valve experienced noisy operation at flow below  $19 \text{ ft}^3/\text{s}$  when the reservoir was at higher levels. Although it was initially suspected that the cause of the noise may have been due to cavitation, it was later confirmed by pumping the stilling well dry that the noise was related to abrasion erosion caused by solid materials being driven against the concrete surfaces by the rapidly circulating water. The materials were likely silt suspended in the flow. The erosion exposed reinforcing steel in the floor. The decision was made to line the entire floor with steel plate in addition to repairing the eroded concrete. The steel lining also extended up the walls. Steel plates with  $\frac{7}{16}$ -inch thickness were used. To hold the lining firmly in place, anchors were placed on 1-foot centers. Grout taps were provided in the lining to allow for low pressure grouting beneath the lining to fill all voids between the lining and concrete. During a 1975 inspection, the stilling well



Figure A-3.—Handwheel control for sleeve valve. The handwheel requires  $3\frac{3}{4}$  turns to fully open the valve from the closed position.

was dewatered and inspected. While the steel lining had performed satisfactorily, additional damage had occurred to the concrete above the steel lining on the walls. Additional steel plates were added to cover these areas.

Vandalism had always been a problem in the area since there was considerable public access and use of the recreation area at the reservoir above. A shield was placed in the opening where the sleeve valve discharge spills into the spillway basin. This prevents people from throwing rocks into the sleeve valve well from the opposite side of the spillway basin. Rocks thrown in the stilling well were suspected to have caused the damage to the concrete observed in 1975. In addition, as a precautionary measure to reduce the possibility of materials causing abrasion erosion in the stilling well, the slope adjacent to the intake structure was flattened in an attempt to prevent material from being drawn into the intake.

Periodic dewatering and inspection of the stilling well has been performed over the years and no further significant deficiencies have been observed.





Figure A-4.—Truncated distributor cone.



Figure A-5.—Outlet works discharge enters the spillway stilling basin through an opening in the right wall.

### **Lessons learned:**

Periodic inspection is necessary to verify operation and performance is within acceptable limits.

Suspended materials in the flow can result in significant abrasion erosion damage requiring structural modifications.

### **References:**

Bureau of Reclamation, RO&M Report Files for Agate Dam, Denver, Colorado.

Bureau of Reclamation, *Standing Operating Procedures for Agate Dam*, Boise, Idaho.

**Project:** Arkabutla Dam

**Location:** Mississippi

**Summary:** Abrasion erosion damage to a stilling basin

Arkabutla Dam is an embankment dam located in northwestern Mississippi on the Coldwater River (figure A-6). The embankment dam was completed in 1943 and is 83 feet high, 10,000 feet long, and controls a drainage area of approximately 1,000 square miles. The dam was designed for the purpose of flood control. At the spillway crest elevation, the reservoir has a storage capacity of 525,000 acre-feet.

The outlet works, located near the south abutment, consist of a concrete approach, three-gated control structure, transition, 325-foot long single-barrel egg-shaped conduit (18.25 feet high and 16 feet wide), transition chute, and stilling basin. The outlet works has a design head of 50 feet and discharge capacity of 10,000 ft<sup>3</sup>/s. The reinforced concrete stilling basin is 143.5 feet long from headwall to end sill. There is a smooth transition from the conduit section at the portal to the trapezoidal basin. The width at the portal is 16 feet and at the end sill it is 88 feet. Essential elements of the hydraulic jump basin includes: a stepped chute that drops 7 feet, a 75-foot long horizontal apron, two rows of stepped baffles, a stepped end sill, and diverging spray and wing walls.

An informal inspection of the stilling basin was made in 1945, two years after the project was put into operation. The three gates were closed, but the basin was not unwatered. This inspection indicated 12 to 15 inches of silt and mud on the basin floor. A second inspection in 1967 under similar circumstances revealed an

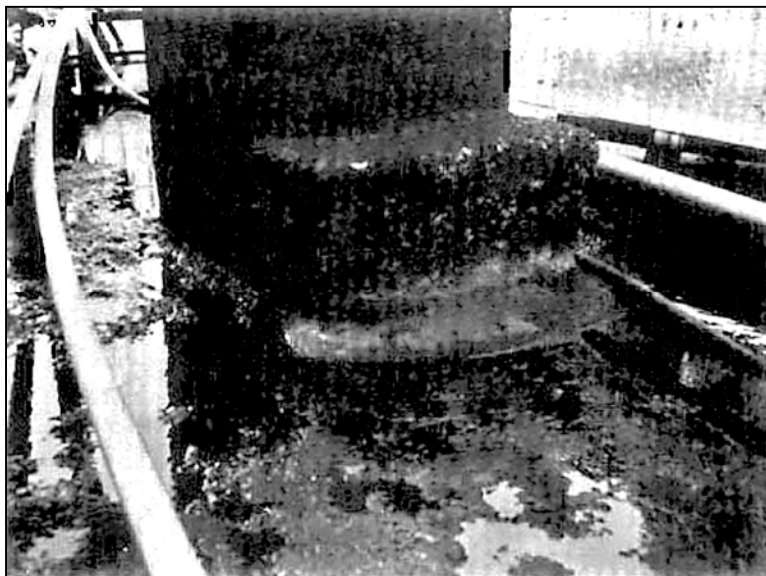

Figure A-6.—Aerial view of the upstream face of Arkabutla Dam.

accumulation of about 4 feet of mud, silt, and riprap. In 1969, the basin was unwatered for the first time to perform the initial periodic inspection. Abrasion erosion had occurred in the stilling basin, exposing reinforcing steel on the corners of three baffle piers (figure A-7) and at three locations on the floor surface. The depth of abrasion erosion was estimated at 5 to 6 inches.



Exposed reinforcement at base of baffle



Temporary repair of erosion

Figure A-7.—Abrasion erosion and repair of the baffle.



Due to the depth of the abrasion erosion at the locations where reinforcement was exposed, it was decided at the time of the 1969 inspection to repair these areas with thin-ply patches of a Portland cement base material mixed with marble dust and a gauging liquid (wetting agent), consisting primarily of polyvinyl acetate with polystyrene. Application of the material was accomplished by cleaning the subject area with water pumps and push brooms. Excess standing water was removed afterward with a compressor and air hose. The area was then spray-primed with a fine mist of gauging liquid. After the area was primed, a thin coat ( $\frac{1}{8}$  to  $\frac{1}{4}$  inches) of the patch mortar was scrubbed into the primed area with stiff push brooms. The area was covered with more mortar and troweled to an even finish slightly above the exposed aggregate and steel in the eroded areas. Upon completion of these repairs it was concluded that no further repairs would be necessary prior to the next inspection.

In 1974, the second periodic inspection indicated continued abrasion erosion of the concrete in the stilling basin since the last inspection. The increase in eroded depth was estimated at approximately 1-inch. The number of areas in the basin slab with exposed reinforcing had doubled since the 1969 inspection (figure A-8). The concrete patches made at the time of the initial inspection appeared in good condition with little effect of abrasion erosion noted. Therefore, it was decided to patch the eight eroded areas with the same material. Two baffles were also repaired in a similar manner.

In 1976, it was decided to restore the stilling basin floor slab and baffles to original grades and dimensions. After gate closure, a sandbag dike was built across the end sill and the stilling basin was unwatered by pumping. Silt and debris were removed from the area by hosing with water and using shovels. Loose concrete and previous temporary repairs were removed with jackhammers. After all surfaces to be repaired were sandblasted, they were thoroughly cleaned and dried prior to application of the epoxy bonding course.

The epoxy resin bonding material was mixed and applied to the receiving surfaces immediately prior to placement of the filler concrete. Stiff stable brooms were used to ensure complete coverage of the receiving surface with bonding. Filler concrete proportioned with  $\frac{3}{4}$ -inch maximum size aggregate (table A-1) for 28-day compressive strength of 4,000 lb/in<sup>2</sup> was placed on the receiving surfaces.

After finishing was completed, the concrete was cured under polyethylene for 3 days. At the end of the curing period, the polyethylene was removed and the surface was lightly sandblasted to remove surface laitance and produced a roughened surface. A light prime coat of neat epoxy was applied to the thoroughly cleaned and dried surface and followed by a  $\frac{1}{4}$ -inch epoxy mortar sealer and wearing course. The mortar, consisting of one part epoxy to three parts silica sand, was mixed in a 4.5 ft<sup>3</sup> mortar mixer. The mortar was finished to desired grade with steel trowels. Existing

## Outlet Works Energy Dissipators

---

expansion joints were replaced with premolded, sponge rubber joint filler and extended upward to the new surface.



Figure A-8.—Exposed reinforcement in the stilling basin downstream of the baffles.

Table A-1.—Filler concrete proportioned with ¾-inch maximum size aggregate

Material	Saturated Surface Dry Weight (in pounds)	Solid Volume (in cubic feet)
Portland cement, type III	611	3.11
Fine aggregate	1,203	7.36
Coarse aggregate	1,932	12.39
Water	258	4.14
Water-reducing admixture	(58 ounces)	--
Total	4,004	27.00

Surface preparation on the baffles was similar to that previously described for the basin floor slabs. Immediately after application of the epoxy bonding material, epoxy mortar was hand-troweled onto uneroded areas of the baffles to a minimum thickness of 1/4-inch. On eroded areas, the thickness of coating was that necessary to restore the baffles to their original dimensions.

**Lessons learned:**

Based on model tests, exit configurations (size and shape of end sill, training wall flare, and shape of the exit channel) should be designed to maximize flushing of the stilling basin and minimize the chances of debris from the exit channel entering the basin. For existing structures, control releases so as to avoid discharge conditions where flow separations and eddy action are prevalent. Substantial discharges that can provide a good hydraulic jump without eddy action should be released periodically in an attempt to flush debris from the basin. Periodic inspections should be completed to determine the presence of debris in the stilling basin and the extent of the erosion.

**References:**

U.S. Army Corps of Engineers, *Maintenance and Preservation of Concrete Structures*, TR C-78-4, April 1980.

## Outlet Works Energy Dissipators

---

**Project:** Clark Canyon Dam

**Location:** Montana

**Summary:** Underwater dive inspection of a type II stilling basin

Clark Canyon Dam is a zoned earthfill structure completed in 1964 located at the head of the Beaverhead River in Montana. The dam has a structural height of 147.5 feet, a crest length of 2,950 feet, and a volume of 1,970,000 cubic yards of material. Clark Canyon Reservoir has a total capacity of 257,152 acre-feet and an active capacity of 126,117 acre-feet. The spillway consists of an approach channel, concrete inlet channel, ungated concrete crest, concrete chute, concrete stilling basin, and an outlet channel. The last time the spillway operated was in 1984.

The outlet works consists of an approach channel; concrete intake structure; concrete conduit; a gate chamber with four 3- by 6.5-foot high pressure gates, two of which serve for emergency upstream of the regulating gates; concrete access shaft and shaft house; and a concrete type II stilling basin. The outlet channel is shared by the outlet works and spillway (figure A-9).

Underwater inspection and documentation were conducted on the outlet works intake structure, outlet works stilling basin, and spillway stilling basin in 2003. Only the outlet works inspection will be discussed further in this case history. Due to the high elevation (dam crest elevation of 5579.1 feet), high altitude diving procedures



Figure A-9.—View looking downstream from top of dam with outlet works stilling basin in middle and spillway stilling basin to the left.

and dive tables were incorporated into the dive plan. At the start of the day, divers and East Bench Irrigation District personnel discussed the underwater work to be performed and the associated Hazardous Energy Clearance procedures to be followed. Gates were closed and locks were placed as needed during the course of the inspection. Locks were removed at the end of the work day. Weather was sunny and mild with an ambient air temperature of 55 °F. Water temperature was 45 °F. Underwater visibility was good, at an estimated 4 to 5 feet. The reservoir water surface elevation was at elevation 5519.4 feet and the spillway stilling and outlet works stilling basins water surface elevation was at elevation 5445.00 feet (tailwater). In-river flows were met by passing 25 ft<sup>3</sup>/s through the outlet works (figure A-10).

In the outlet works stilling basin, the chute blocks were found to be in good condition with some broken edges and slight rounding of the outside corners of the concrete. All the underdrains were clear and flowing a small amount of clear, cold water. The floor in the area of the chute blocks had exposed aggregate and relief of up to 1.5 to 2 inches (figure A-11).



**Figure A-10.**—View looking upstream at the outlet works stilling basin. During the inspection of the basin, approximately 25 ft<sup>3</sup>/s was flowing through the outlet works.





**Figure A-11.**—View looking upstream at outlet works stilling basin left chute block underdrain. The drain is clear and flowing. Note edge relief of the chute block and the exposed vertical rebar on the left side of block. Concrete erosion of block is approximately 1.5 to 2 inches.

Located from approximately Stations 14+10 to 14+35 was a gravel bar consisting of 75 percent 1-inch minus subrounded to rounded material with a maximum size of 3 inches. The gravel bar was in the center of the basin and was rectangular in shape with rounded corners, 4 feet to 8 feet wide, and approximately 25 feet long with a maximum depth of 12 inches. The concrete floor in this area, where visible, had exposed aggregate and relief of up to 1-inch. Immediately downstream of the gravel bar area, from Stations 14+35 to 14+60, was an area of exposed rebar with a maximum width of 15 feet in the center that fairly uniformly decreased to zero at each end. The estimated relief from the original floor surface was up to 2½ inches or more, with 1-inch diameter transverse bars exposed up to a maximum of ¾ inch ([figure A-12](#)). The longitudinal bars were located underneath the transverse bars. Intermittent small pockets of subrounded to rounded gravel up to 3 inches in diameter were present within the area of exposed rebar.

From approximately Stations 14+60 to 14+85, the floor of the basin was clear with relief generally varying from ½-inch at the upstream end to ¼-inch at the downstream end. From approximately Stations 14+85 to 15+09 (the upstream face of the dentates), the floor relief varied from ¼-inch at the upstream end to smooth at the downstream end. The concrete surface of the dentates was smooth and in good condition with well defined corners ([figure A-13](#)).



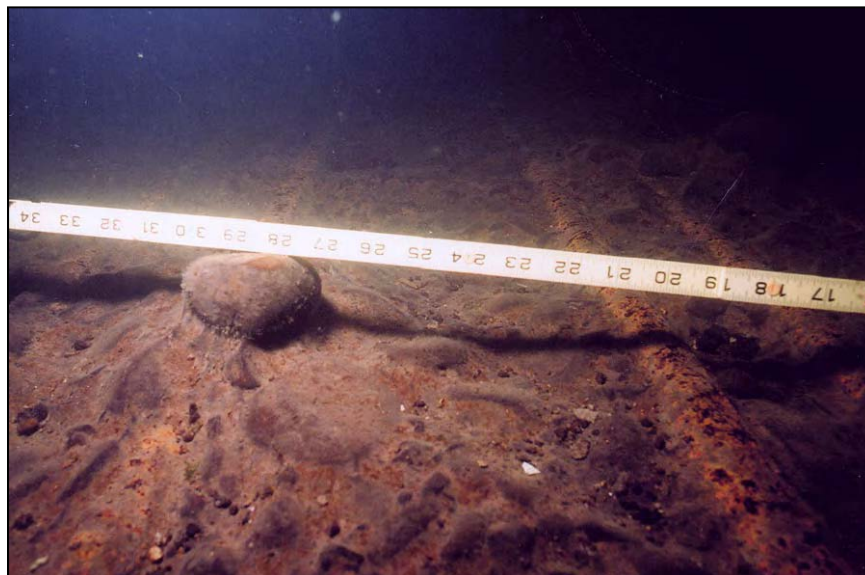

Figure A-12.—View of outlet works stilling basin showing 3-inch diameter aggregate still attached to concrete matrix. Erosion of floor is approximately 4 inches. Note exposed rebar on the right side of the photograph.



Figure A-13.—View looking downstream at far left dentate showing the general condition of outlet works stilling basin dentates. All dentates were in good condition with well defined edges and corners. No chipping of edges was noted.

The gravel bar in the outlet works stilling basin contains approximately 8 cubic yards of rounded material. This gravel bar was located upstream in the 1997 underwater examination and has moved downstream to the dentates. With continued outlet

works flows, this bar will eventually fill in around the dentates with the next large flow of the outlet works, and with extended flows can cause concrete erosion of the dentates. The concrete erosion on the floor of the basin documented in 1997 seems to be increasing in both area and depth (figure A-12). The area of the erosion is now approximately 390 ft<sup>2</sup> compared to approximately 190 ft<sup>2</sup> in 1997. The depth of erosion is now more than 6.5 inches as compared to the 2 inches documented in the 1997 report (figure A-14).



Figure A-14.—View of outlet works stilling basin showing larger exposed transverse rebar and lower longitudinal rebar. Erosion of floor in this area is approximately 6.5 inches. Lack of rust accumulation on rebar indicates active scour of basin floor.

### Lessons learned:

The rock material should be removed from the stilling basin prior to large releases and the eroded concrete and exposed rebar should be repaired.

Underwater inspections should be performed regularly to monitor material deposits and concrete conditions.

Additional concrete cover should be provided in stilling basin floor slabs.

### References:

Bureau of Reclamation, *Memorandum: Underwater Examination, Outlet Works Intake Structure, Outlet Works and Spillway Stilling Basins, Clark Canyon Dam, East Bench Unit, Three Forks Division, Pick-Sloan Missouri Basin Program, Montana*, 2003.

**Project:** Enid Dam

**Location:** Mississippi

**Summary:** Abrasion erosion damage to stilling basin

Enid Dam (figure A-15) is located on the Yocona River in northwestern Mississippi, approximately 12 miles south of Batesville. The dam and appurtenances were placed in operation for flood control in December 1952. Major features of construction were completed in August 1955.

The dam is composed of a main embankment, emergency spillway and an outlet works. The dam is a rolled fill structure, with a total length approximately 8,400 feet. The crest width is 30 feet at elevation 293 feet. The maximum height above streambed is 103 feet. The outlet works is located near the north abutment. The approach is trapezoidal in cross section and is 32 feet wide and 56 feet long. The outlet works has two 8- by 16-foot tractor-type service gates with one emergency gate. The spillway is located immediately north of the north end of the dam and is an uncontrolled type consisting of a concrete approach, weir, chute and stilling basin. The approach is at elevation 246.5 feet on the upstream end, elevation 258 feet on the downstream end and is 190 feet long and 200 feet wide. The weir crest is elevation 268 feet and is 200 feet wide.



Figure A-15.—Aerial view of the downstream face of Enid Dam.

## Outlet Works Energy Dissipators

The outlet works consists of a concrete approach, two-gated control intake structure, a transition, a two-barreled conduit, chute, and stilling basin. The design of discharge capacity is 9,400 ft<sup>3</sup>/s. The stilling basin (figure A-16) is 172 feet long from

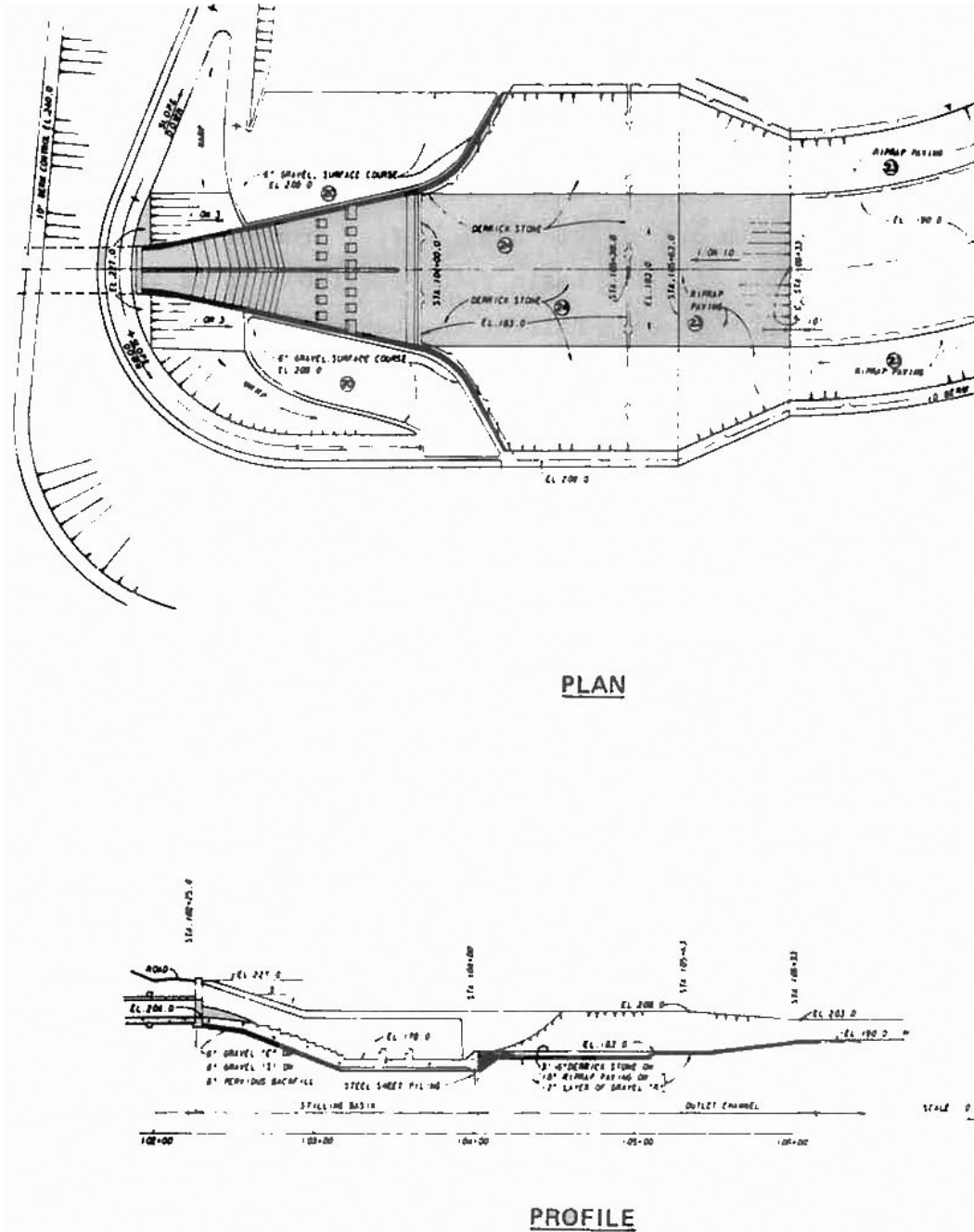

Figure A-16.—Plan and profile of the outlet works stilling basin.

headwall to end sill. A longitudinal splitter wall in the center of the structure, running from headwall to within 10 feet of the end sill, divides the basin into two symmetrical halves. The shape of the chute at the portal coincides with the inverts of the twin circular (11-foot diameter) conduit section, and the chute has an overall width of 30 feet. From elevation 204 feet, the chute drops by steps to the stilling basin floor (elevation 178 feet); it is 42 feet wide at the stilling basin. In each half of the basin, a smooth transition from semicircular to trapezoidal section is provided by means of constant radius fillets. The length of this transition is about 38 feet. The stilling basin is 95 feet wide at the sloping face end sill, which is 5 feet high. The stilling basin floor is surmounted by two rows of baffles 6 feet high and 5 feet wide, spaced on 10-foot centers.

The reinforced concrete stilling basin walls and base slab were designed as a framed structure. The base slab was analyzed by elastic beam theory resting on an elastic foundation. Wall stems were designed as cantilevers. The minimum thickness of the basin slab is 5 feet with a 3,000 lb/in<sup>2</sup> design compressive strength concrete.

An informal inspection of the stilling basin in 1959 revealed a heavy deposit of silt, which was removed from the basin. The initial periodic inspection in 1968 revealed eroded and pitted surfaces on the stilling basin floor, steps, and baffle piers. The deepest abrasion erosion into the concrete was about 5½ to 6 inches in the stilling basin floor in an area approximately 3½ to 4½ feet north and south, respectively, of the splitter wall and approximately midway between the lower step and first line of baffles (figure A-17). In the south passage, seven reinforcing bars were exposed from 1 to 11 inches in length. In the north passage, four bars were exposed from 1 to 7 inches in length. All joints appeared to be in good condition and no deep cracks were observed. There was no visible deflection in wing walls or center wall.

Areas with the most advanced abrasion erosion were repaired at the time of the 1968 inspection with a temporary protective coating. The material and method of application was the same as previously described for the Arkabutla case history. Although abrasion erosion on the steps was not as extensive as that on the stilling basin floor, two test patches were made on the seventh step (elevation 192 feet), in both the north and south passages. These patches were exposed each time the gates were closed so that durability could be monitored.

In 1973, the second periodic inspection of the stilling basin indicated continued abrasion erosion of the concrete at an increasing rate. The temporary repairs to the basin floor in 1968 had eroded except for a few small areas.

In both the north and south portions of the stilling basin the major areas of abrasion erosion were located approximately 5 to 6 feet from the splitter wall and midway between the lower step and first row of baffle piers (figure A-18). In addition, there were two deeply eroded areas in each passage, approximately 3 feet from the splitter



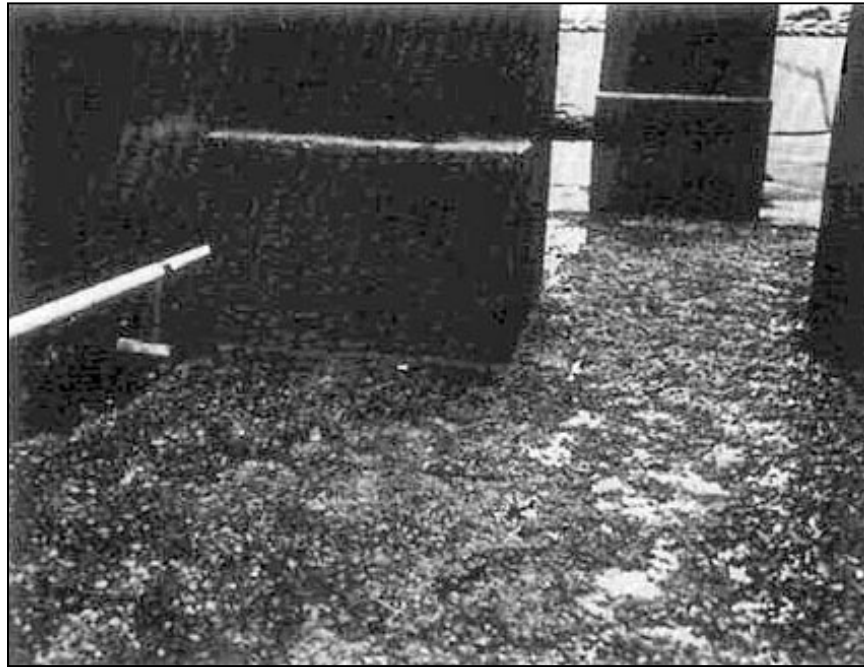

Figure A-17.—Abrasion erosion in the north passage of the stilling basin.

wall and midway between the two rows of baffles. Maximum depth of abrasion erosion was approaching 1-foot. Nine reinforcing bars were exposed in the south passage, ranging from 2 to 14 inches in length. In addition, in the north passage, six reinforcing bars were exposed, ranging in length from 2 to 12 inches. Until permanent repairs could be made, these areas with exposed reinforcement were temporarily repaired with the protective coating previously used.

In 1976, permanent repairs were made to the stilling basin floor slab and baffles. This work was accomplished under the same contract with essentially the same materials and techniques previously described for the [Arkabutla case history](#). The stilling basin slab was restored to original grade with an epoxy-bonded unreinforced concrete overlay (approximately 93 yd<sup>3</sup>) and epoxy mortar sealer and wearing course.

The stilling basin was unwatered for inspection in August 1978, approximately 2 years after completion of repairs. The inspection indicated an excellent bond between the epoxy mortar and fill concrete. With the exception of a relatively small area on each side of the longitudinal splitter wall, the epoxy mortar exhibited good resistance to abrasion erosion. In both cases, abrasion erosion occurred in a generally circular pattern around the upstream baffle nearest the splitter wall. The abrasion erosion pattern generally coincided with the areas of maximum abrasion erosion prior to repair. The maximum depth of abrasion erosion, which occurred in the north passage, was approximately 1/2-inch. The condition of the mortar due to



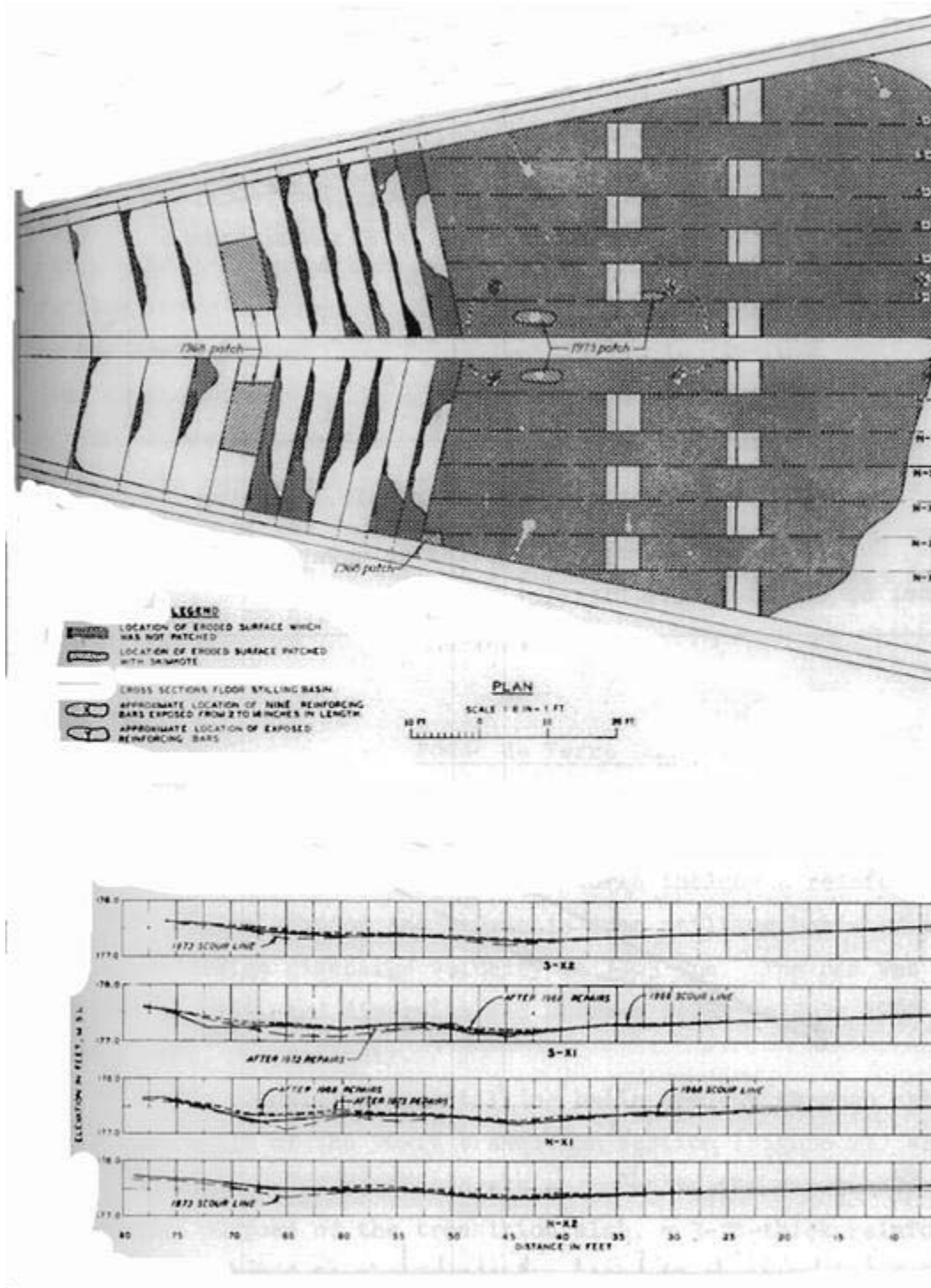

Figure A-18.—Stilling basin cross sections.

moisture seepage at construction joints was of some concern during the repair. However, the mortar in these areas appeared to have exhibited the same behavior as that elsewhere, with the exception of the joint. The baffles were in excellent condition with no evidence of abrasion erosion.

### **Lessons learned:**

Based on model tests, exit configurations (size and shape of end sill, training wall flare, and shape of the exit channel) should be designed to maximize flushing of the stilling basin and minimize the chances of debris from the exit channel entering the basin. For existing structures, control releases so as to avoid discharge conditions where flow separations and eddy action are prevalent. Substantial discharges that can provide a good hydraulic jump without eddy action should be released periodically in an attempt to flush debris from the basin. Periodic inspections should be completed to determine the presence of debris in the stilling basin and the extent of the erosion.

### **Reference:**

U.S. Army Corps of Engineers, *Maintenance and Preservation of Concrete Structure*, TR C-78-4, April 1980.

**Project:** Elkhead Creek Dam

**Location:** Colorado

**Summary:** Fixed-cone valve and concrete lined plunge pool

Elkhead Creek Dam is situated on Elkhead Creek a tributary to the Yampa River in northwestern Colorado about 10 miles east of Craig. The dam is a rolled earthfill embankment with a height of 110 feet and a crest length of 1,300 feet and crest elevation of 6,403 feet. The dam was original constructed in 1979 and the reservoir was enlarged in 2005 by raising the dam crest 25 feet, which doubled the storage capacity of the reservoir. The reservoir now has a surface area of 670 acres and storage capacity of 25,000 acre-feet. The purpose of the dam and reservoir is to provide a water supply for the City of Craig, recreation, irrigation and recovery of endangered fish species along the Yampa River.

Elkhead Creek Dam was enlarged to double the reservoir storage capacity by raising the dam crest 25 feet. The designer selected a downstream slope raise to facilitate the dam crest raise. As part of this enlargement project, the downstream toe of the existing dam was required to be extended downstream. This required the existing downstream energy dissipator structure for the outlet works to be moved downstream and the outlet conduits to also be extended downstream. Due to ongoing problems and safety concerns with the existing outlet works, the dam owner decided to abandoned the existing outlet works in place and construct a new outlet works at the left abutment of the dam. [Figure A-19](#) shows the completed energy dissipation structure.

The new outlet works consists of an upstream intake tower, a steel lined outlet tunnel and a downstream control house and dissipation structure with downstream control valves. The outlet works for Elkhead Creek Dam is designed for 98 feet of head and to provide flows ranging from 5 to 500 ft<sup>3</sup>/s. The outlet works provides the capability to evacuate the top five feet of the reservoir in five days to meet Colorado State Engineer's Office emergency drawdown requirements.

The outlet works consists of a vertical 96-foot tall intake structure connected to an outlet control house by a 6-foot diameter steel lined concrete encased conduit. Releases are controlled by three valves in the control house. This configuration was selected to:

- Provide a relatively simple and economical outlet works consistent with current practice for reservoir outlet works design.



**Figure A-19.**—View of the completed energy dissipation structure for Elkhead Creek Dam with 42-inch diameter fixed-cone valve in background.

- Provide multiple, redundant outlets including capability to isolate and drain conduits for inspection and allow access to equipment.
- Provide a range of outflows to meet downstream discharge requirements during different times of the year.

The tunnel alignment runs through the left abutment in rock along its entire length.

A vertical intake tower is located at the upstream end of the outlet works. The tower has four large knife gates and one small knife gate. The bottom gate at elevation 6,308 feet is a 72-inch diameter knife gate that controls discharge into the 72-inch diameter steel conduit running the length of the outlet works tunnel. The electrically operated gate is used to isolate the conduit for draining and normal inspection and maintenance. The smaller 24-inch diameter knife gate at elevation 6309 feet, feeds a 24-inch diameter by-pass conduit that can be used during maintenance of the 72-inch diameter conduit or used to increase discharge capacity of the system.

Drum screens were attached to each knife gate to prevent fish escapement through the intake tower during operation. One of the drum screens was designed to be removable to allow for the passage of flow in the event the screens become blocked. This screen is attached to the 72-inch diameter knife gate located at the base of the intake tower. All of these gates will be used for selective level withdrawal. The knife gates are operated using electric power with manual backup.

A reinforced concrete structure (located on top of the intake tower) houses the electrically operated knife gate and the drum screen operators. The elevation of the top of the intake structure is elevation 6403 feet, approximately 1.5 feet above the Probable Maximum Flood surface and even with the crest of the dam. The drum screens are sized for a velocity limitation of 4 ft/s. This limitation was selected to minimize the possibility of pinning fish against the screens.

A 6-foot diameter steel lined tunnel was constructed through the left abutment of the dam. The steel pipe is designed to carry the full internal pressures of the system. The inside of the pipe was epoxy coated. A manhole near the control house provides access for inspection and maintenance.

A control house is located near the downstream toe of the raised dam. This structure houses three valves that control emergency and normal releases. A 42-inch diameter fixed-cone valve is used for reservoir drawdown and an 18-inch diameter jet-flow gate is used for normal releases. A 14-inch diameter submerged knife gate valve is used for winter releases. The 18-inch diameter jet-flow is remotely controlled from the City of Craig. Water level and gate position instrumentation are included in the control house.

The 42-inch diameter fixed-cone valve and 18-inch diameter jet-flow gate have a maximum discharge capacity of approximately 525 ft<sup>3</sup>/s (at Maximum Normal Pool—elevation 6,388 feet). Each outlet has an individual concrete energy dissipator on the downstream side of the control house.

The rectangular box energy dissipation structure for the 42-inch diameter fixed cone is based on similar designs developed by Reclamation and others and is being used successfully at Friant, Los Vaqueros, and other dams. The jet from the fixed-cone valve hits the chamber floor, walls, and roof and then discharges to the downstream channel. The jet from the jet-flow gate impacts onto a sloping concrete baffle, similar to Reclamation impact-type stilling basin, and is deflected down into a plunge pool and then discharges to the downstream channel. A riprap lined trapezoidal channel connects the energy dissipation structure to downstream Elkhead Creek.

[Figure A-20](#) shows a plan and profile of the stilling basin.

Operational tests were conducted to verify performance of the fixed-cone valve and jet-flow gate. [Figures A-21](#) through [A-24](#) show the testing of the outlet works and stilling basin.

Figure A-20.—Plan and profile of the stilling basin.

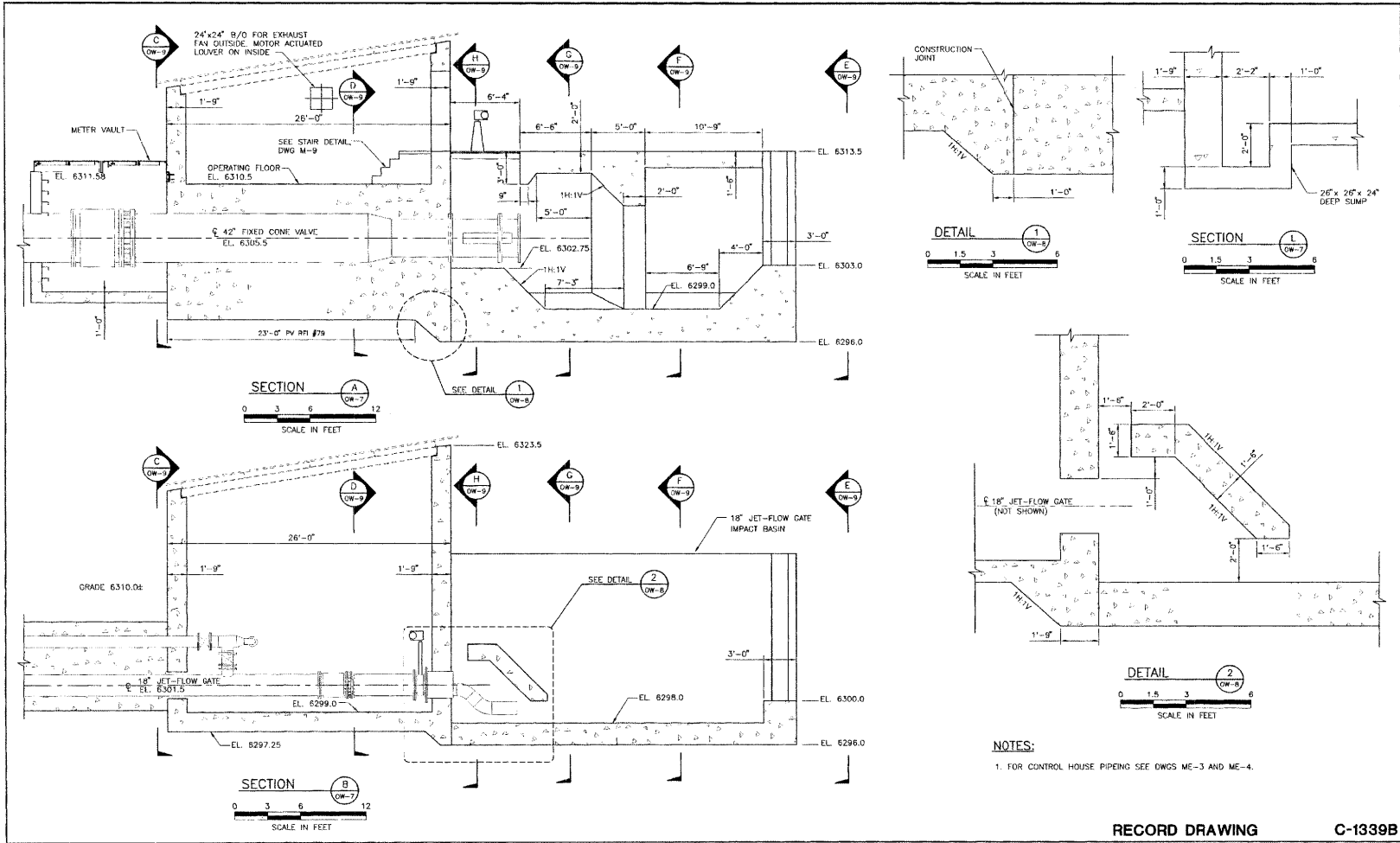





Figure A-21.—View of 42-inch diameter fixed-cone valve under low flow conditions.



Figure A-22.—View of 42-inch diameter fixed-cone valve discharging at about 20 ft<sup>3</sup>/s.



Figure A-23.—View of 18-inch diameter jet-flow gate discharging at about 50 to 70 ft<sup>3</sup>/s (near maximum discharge capacity).



Figure A-24.—View of outlet channel from energy dissipation structure.

**Lessons learned:**

After the completion of the outlet works, the outlet works and stilling basin were subjected to a full range of discharges up to approximately 500 ft<sup>3</sup>/s. During testing of the outlet works, the stilling basin performed normally as designed.

The jet-flow gate operates frequently for significant durations at the low end of its capacity, approximately 5 to 20 ft<sup>3</sup>/s out of a maximum of 75 ft<sup>3</sup>/s. Until the flow exceeds about 20 ft<sup>3</sup>/s, the jet misses the sloped energy dissipator, passing under it, across the stilling basin floor and hits the end sill going nearly straight up. This creates a lot of spray which is a concern in severe cold conditions that could potentially lead to significant ice build up, but this has not been a big issue to date during operation. Long-term wear of the floor of the stilling basin from high velocity water is also a concern. Once over 20 ft<sup>3</sup>/s is discharged, the hydraulic conditions allow submergence of the downstream edge of the sloped deflector and the system backwaters, and then very quiet water flows in an orderly manner over the end sill of the stilling basin.

The fixed-cone valve stilling basin has an abrupt plunge at the downstream face onto riprap. The sill of the cone valve stilling basin is not backwatered by the downstream riprap portion of the stilling basin even under highest combined spillway and outlet discharge experienced to date (about 2,000 ft<sup>3</sup>/s). During the initial operation of the outlet works, the fall of discharge over the end sill onto the riprap displaced some riprap just downstream of the fixed-cone valve stilling basin. This was repaired with larger riprap for the full depth of the displaced section, and performance has been satisfactory since then, although some subsequent rock movement has been noted, this condition will require continual monitoring and maintenance.

**References:**

URS Corporation, *Elkhead Creek Dam Enlargement Project*, Final Design Report, Section Nine, 2005.

**Project:** Ganado Dam

**Location:** Arizona

**Summary:** Design and construction of a type VI stilling basin

Ganado Dam is located on the Navajo Indian Reservation in northeast Arizona, approximately 2 miles northeast of the town of Ganado. The dam is an offstream structure and receives water from the Pueblo Colorado Wash via a nearby diversion structure. The primary purposes of the dam are irrigation and recreation. The dam was modified from 1994 to 1995 due to dam safety deficiencies and concerns. The original dam, constructed in 1919, was a homogeneous earthfill approximately 17.5 feet in height. The dam was raised 5.5 feet in 1943 to a crest elevation of approximately 6435.0 feet with a crest length of 3,300 feet and capable of impounding approximately 2800 acre-feet of water with the water surface elevation at the spillway crest (elevation 6433.3 feet). Appurtenant structures at the dam included a spillway and an outlet works. The spillway consisted of an uncontrolled mortar-stone overflow section constrained by two 40-inch diameter corrugated metal pipe (CMP) culverts. The outlet works consisted of a 24-inch by 15-inch concrete box conduit controlled by a 24-inch slide gate controlled from the crest of the dam. The reservoir had a history of seepage problems since its initial construction. The reservoir was finally drained in 1985, when breaching began in a downstream section of the dam. The dam remained in a drained condition thereafter. A CCTV inspection was performed May 1991, to determine the condition of the outlet works conduit. The inspection showed calcium deposits, deteriorated joints, erosion, and cracks throughout the outlet works conduit. The deteriorated condition of the outlet works concrete provided a potential pathway for internal erosion of embankment materials to occur.

The dam safety modifications included completely removing the existing embankment, excavating a cutoff trench, and constructing a new zoned earthfill dam with a crest elevation of 6440 feet, including a toe drain system downstream of the dam, a 15-foot wide spillway, and a 36-inch diameter outlet works including gates and an outlet channel, and other minor items. Construction of the dam modifications began in September 1994 and was completed by December 1995 ([figure A-25](#)).

As part of the outlet works replacement, an energy dissipation stilling basin was constructed at the downstream end of the outlet works conduit. The stilling basin is an impact type reinforced concrete hanging baffle stilling structure with a length of 14 feet 10 inches, a width of 9 feet 3 inches, and a height of 8 feet 2 inches. Flow entering the stilling basin impinges upon a hanging baffle energy dissipator and flows under the baffle and out the stilling basin into a riprap lined discharge channel.





Figure A-25.—Overall view of completed dam modifications from downstream right abutment. The outlet works stilling basin is located in the left center of the figure.

#### Design:

The maximum discharge through the outlet works at normal water surface elevation 6433.3 feet is 69 ft<sup>3</sup>/s.

The stilling basin was designed using the working stress design procedures assuming 4,000 lb/in<sup>2</sup> concrete in 28 days and 60,000 lb/in<sup>2</sup> reinforcement. The working stress design method is preferred for any structures considered to be an integral part of a hydraulic structure where crack control limitations are important. A 1.33 overstressing factor was used for unusual loads and a 1.50 overstressing factor for extreme loads. A Maximum Credible Earthquake (MCE) of 6.0 at 12 kilometers producing a peak horizontal ground acceleration of 0.275 g was used for the extreme seismic event.

The loading conditions used for structural analysis of the stilling basin were as follows:

- Saturated fill outside of the structure with no water loads within the structure. This was considered a usual loading condition.
- Saturated fill outside the structure, no water load inside the structure and subject to the MCE seismic event. This was an extreme loading condition.
- Uplift caused by maximum reservoir water levels with no water load in the stilling basin and no underdrains operating. This was considered an unusual loading condition.

## Outlet Works Energy Dissipators

---

The loads were determined and applied to the structure. Moments and shear were calculated assuming 1-foot wide fixed end and cantilever beams to determine the maximum shear and moments at selected sections of the stilling basin.

The material properties used in the design were:

Concrete:

$$f'_c = 4,000 \text{ lb/in}^2 \text{ at 28 days}$$

$$\text{Weight} = 150 \text{ lb/ft}^3$$

$$\text{Modulus of elasticity} = 3.83 \times 10^6 \text{ lb/in}^2$$

$$\text{Poisson's ratio} = 0.20$$

Reinforcement:

$$f_y = 60,000 \text{ lb/in}^2$$

Backfill:

	<u>Unit weight</u>	<u>Angle of internal friction</u>	<u>Cohesion</u>
Dry	111 lb/ft <sup>3</sup>	30 degrees	8 lb/in <sup>2</sup>
Saturated	129 lb/ft <sup>3</sup>	30 degrees	2 lb/in <sup>2</sup>

### Construction:

Construction of the stilling basin was part of the overall construction of the outlet works, but only the stilling basin construction will be discussed within this section of the case history.

The existing stilling basin structure was removed by excavation using a Komatsu PC400 excavator and a Caterpillar 988 front end loader. The concrete and unsalvageable materials were stockpiled on site until July 1995, when they were buried in one of the borrow areas.

After the foundation was prepared by compacting Zone 1 embankment materials, the carpenter crews began installing forming for the concrete placements and installing reinforcing steel (figure A-26). Concrete for the stilling basin floor was placed first followed by the walls, baffle, and ceiling. Concrete was placed using a Schwing concrete pump truck. The interior surface of the stilling basin was steel lined and a two-wire flush mounted corrosion monitoring system was attached to it. When the stilling basin structure was completed and the concrete had gained sufficient strength, the dam embankment was compacted about it. Figure A-27 shows the stilling basin after about 7 years of operation.

A 5-foot high chain link fence was installed around the stilling basin due to public safety concerns.





Figure A-26.—Construction crew installing forms for concrete placement of the stilling basin wingwalls.



Figure A-27.—View looking upstream at the completed outlet works stilling basin and discharge channel. The structure just to the right of the stilling basin is a toe drain inspection well.

**Lessons learned:**

When no concrete batch plants are located within remote project areas, consideration should be given to a temporary onsite batch plant or dry batching of

## Outlet Works Energy Dissipators

---

the concrete (a dry-batch plant delivers the dry concrete materials into the transit mixer vehicle and injects the necessary volume of water at the same time).

When no supply of construction water is available, consideration should be given to purchasing water for construction from any nearby towns for delivery and storage of this water at the damsite.

Vandals have thrown smaller pieces of riprap into the basin, although this has not been considered a significant problem.

### **References:**

Bureau of Reclamation, *Final Construction Report—Ganado Dam Modification*, Volume 1, April 1996.

**Project:** Guadalupe Flood Control Project

**Location:** California

**Summary:** Displacement of articulated concrete blocks

The Guadalupe River Project consists of approximately 2.6 miles of channel improvements through downtown San Jose to provide improved flood protection, riparian habitat, and recreation for the area. While this case history does not involve a dam or stilling basin, it does illustrate problems that can be encountered with articulated concrete blocks. A schematic of the project is shown in [figure A-28](#).

Project features include:

- A 0.6-mile-long double-barrel buried box culvert that parallels the east bank of the natural river channel. One culvert is 17 feet high by 30 feet wide and the second culvert is 17 feet high by 24 feet wide ([figure A-29](#)).
- Erosion control measures using cellular concrete mats (CCMs). The channel bed is approximately 3,000 feet long and armored using CCMs, incorporating a low flow channel section for fish passage.

A December 2002 flood displaced installed CCMs at few locations in the upstream section of Phase 3C. The flood is believed to have had a peak of about 6,000 ft<sup>3</sup>/s ([Mifkovic, 2003](#)). The CCM displacements occurred a few yards downstream from where the natural channel meets the improved channel. The flood event eroded both banks of the natural channel ([figure A-30](#)) and carried the eroded material through the improved section.

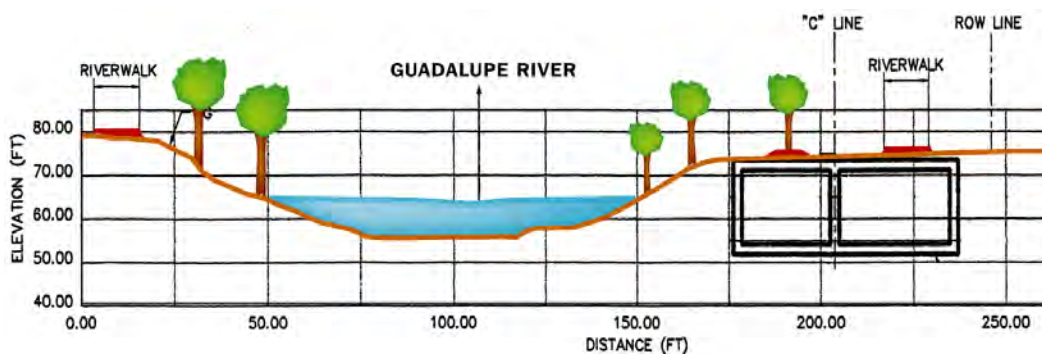

Figure A-28.—Guadalupe River Project Design Schematic.





Figure A-29.—Culvert Under Sobrato Business Park.



Figure A-30.—Eroded upstream bank.

Observations during field visits conducted on January and February of 2003 included:

- Uplifted CCMs were near a bridge pier ([figure A-31](#), an area of high water velocities and turbulence). A cabling system held the CCMs together.



Figure A-31.—Uplifted CCM mats near the bridge pier.

- Concrete blocks were lifted from their foundation at the side slope of the low flow channel. Their displacement was accompanied by a loss of granular filter material (figure A-32). The reason was not clear whether the blocks were pushed up by flow of foundation side slope soil or if they were first lifted by the water and the foundation/granular filter material was lost from beneath them.
- At some locations, the concrete blocks bridged breaks in the grade of the foundation surface, leaving open spaces between the bottom of the block and the granular filter soil.
- The top surface of the concrete blocks showed significant abrasion (figure A-33). The reason was not clear whether the abrasion was caused by water flow or by the eroded bank material grinding against the blocks' surfaces.
- Anchors were only installed at the edge of the CCMs.
- Not all seams between adjacent CCMs were grouted. Some cables did not seem to have the proper tension.





Figure A-32.—Uplifted blocks with loss of granular filter material.



Figure A-33.—Abraded concrete block surfaces.

Based on a review of project specifications, contractor submittals and independent calculations, the following issues might have contributed to the CCM displacements:

- Anchors were placed only at the edge of the overall CCM covered surface and around bridge piers. No anchors were placed within the CCMs or in the low flow channel.



- The contractor selected an unusually small protrusion height (0.28 inches) for the concrete blocks. A more typical design protrusion height is 0.5 inches. A protrusion height of 0.5 inches would have resulted in the selection of heavier and more stable blocks. Technical specifications were not sufficiently explicit regarding the use of a 0.5-inch protrusion height when using an analytical free-body method for design.
- The contractor's design was based on a maximum slope of 2H:1V. The low flow channel where one of the displacements occurred had side slopes of 1H:1V.
- Water turbulence, an ungrouted/unanchored seam near the bridge pier, and lack of tension in the cabling system might have contributed to the lifting of the CCMs in that area.

**Lessons learned:**

The following recommendations were proposed for CCM construction during subsequent phases of the Guadalupe Project:

- CCM design should follow the [Federal Highway Administration's \*Bridge Scour and Stream Instability Countermeasures\*, FHWA-HI-97-030 \(1997\)](#).
- The contractor should submit design calculations showing the concrete blocks will be stable under their own self weight and not rely on cables, anchors or grouting for stability. Anchors, cables, and grouting should provide redundancy to the installed system or for use in areas where dynamic forces may be higher than typical.
- The use of block stability data extrapolated from laboratory tests should not be allowed. If laboratory data specific to the proposed concrete block is not available, calculations should be provided showing that the proposed blocks are secured against overturning (using the free body rotational force balance method).
- The design should be based on a protrusion height of 0.5 inches and be checked for all grades within the project.
- Revetment cables should be polyester; the anchor body should be galvanized steel. These materials were recommended for consistency with the rest of the project. CCMs should be installed with no slack at the earth anchors or in the cables.

## Outlet Works Energy Dissipators

---

- Discontinuities or protrusions greatly increase the forces for overturning. At locations where discontinuities are more likely to occur the system should be grouted. Grouting (nonshrink grout) should be required at the following locations:
  1. At all spaces between blocks and uncovered soil areas, walls, piers, gabions or other structures/features.
  2. Between adjacent CCMs.
  3. Between blocks forming a 10-degree angle.
  4. Around blocks in the 1H:1V sloped areas (low flow channel side slopes).
  5. At exposed 2H:1V slopes.
  6. Anchor spacing should be as per design calculations. Anchors should be placed along the edge of the CCM covered areas and all uncovered soil areas, walls, piers, gabions, and other structures.

### References:

Guadalupe River Project Correspondence and Project Files.

Federal Highway Administration, *Bridge Scour and Stream Instability Countermeasures*, Publication FHWA-HI-97-030, 1997.

Mifkovic, C., *Field Trip Notes, Guadalupe River, San Jose CA*, 2003.

**Project:** Kinzua Dam

**Location:** Pennsylvania

**Summary:** Stilling basin experiences abrasion erosion damage and the subsequent repairs

Kinzua Dam was completed in 1966 and is located on the Allegheny River in Warren County, Pennsylvania, approximately 198 miles above the mouth of the river at Pittsburgh, Pennsylvania. The project is operated as a flood control dam with summer pool at elevation 1328 feet and winter pool at elevation 1300 feet. The project consists of an earth and rockfill dam embankment with a maximum height of 177 feet and top elevation of 1375.0 feet, an overflow spillway with a crest elevation at 1341.0 feet in the concrete-gravity section equipped with four 24-foot high by 45-foot width tainter gates, and an outlet works consisting of six low level sluices at elevation 1205 feet and two higher level sluices at elevation 1300 feet which discharge through the concrete gravity dam section into the spillway stilling basin (figure A-34). The sluices are all 10-foot high by 5-foot, 8 inches wide. The seepage control features include an upstream impervious blanket, an upstream cut-off wall, and an inclined and horizontal drain in the downstream shell. The maximum pool elevation for the Probable Maximum Flood, based on the National Oceanic and Atmospheric Administration's Hydrometeorological Report No. 51, has been estimated to be at elevation 1375.0 feet, which is equivalent to the top of the dam.



Figure A-34.—Aerial view of Kinzua Dam.

## Outlet Works Energy Dissipators

The stilling basin is a hydraulic jump type basin (figures A-35 and A-36) with a length of 178 feet and a width of 204 feet. The basin contains nine baffles, which are 8 feet high, 10 feet wide, and 18 feet 8 inches long and are located 55 feet 7 inches upstream of the end sill. The end sill is 11 feet high and 6 feet wide and extends across the entire stilling basin. Both the end sill and the baffles are keyed into the underlying rock by cutoffs extending 6 feet below the stilling basin floor slab. The articulated floor slab has contraction joints at approximately 30-foot centers longitudinally and 21-foot 6 inches in the transverse direction. The minimum thickness of the slab is 5 feet. Anchorage was provided by No. 11 anchors spaced at 7-foot 2-inches centers in the transverse direction and 10-foot centers longitudinally. Except for the anchors, no reinforcement was provided in the upstream part of the stilling basin. Reinforcement, however, was provided in the baffles, end sill, and

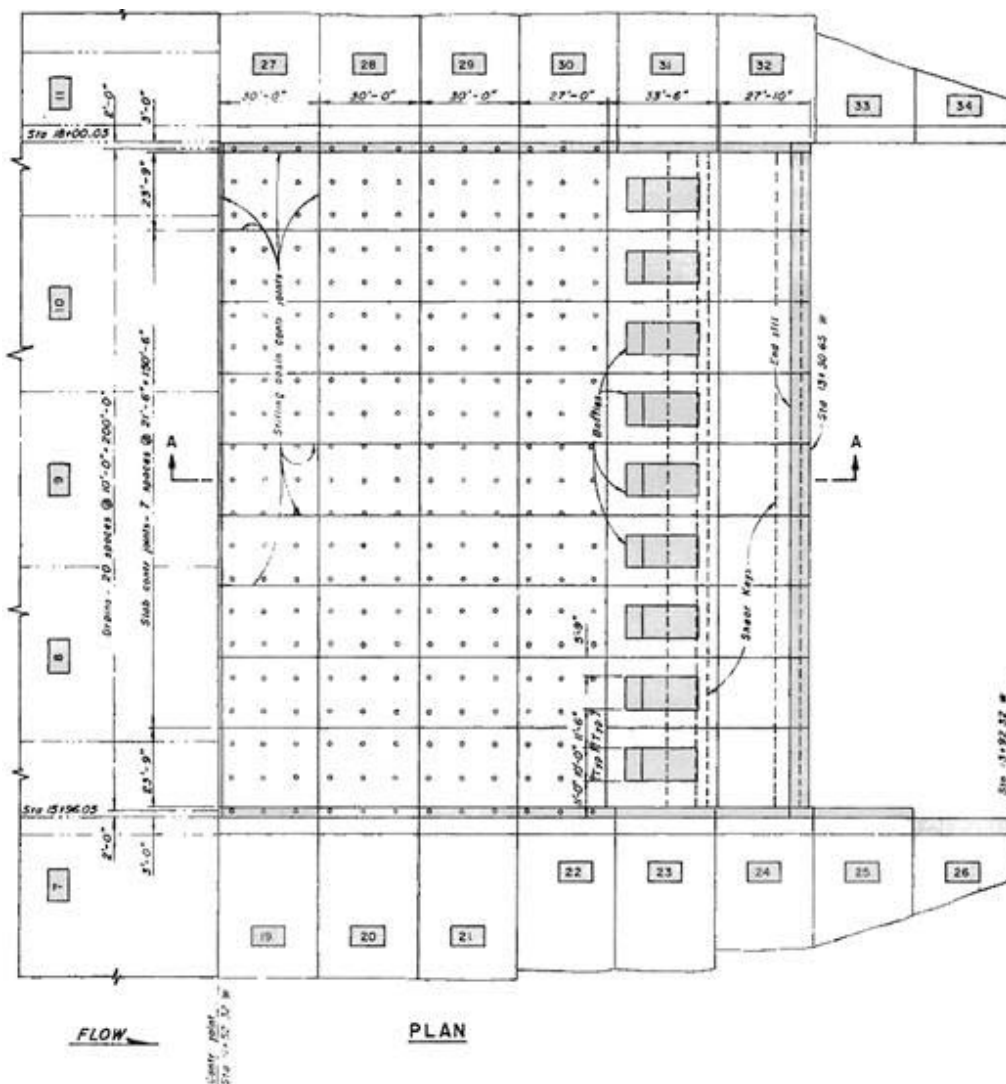

Figure A-35.—Stilling basin plan.

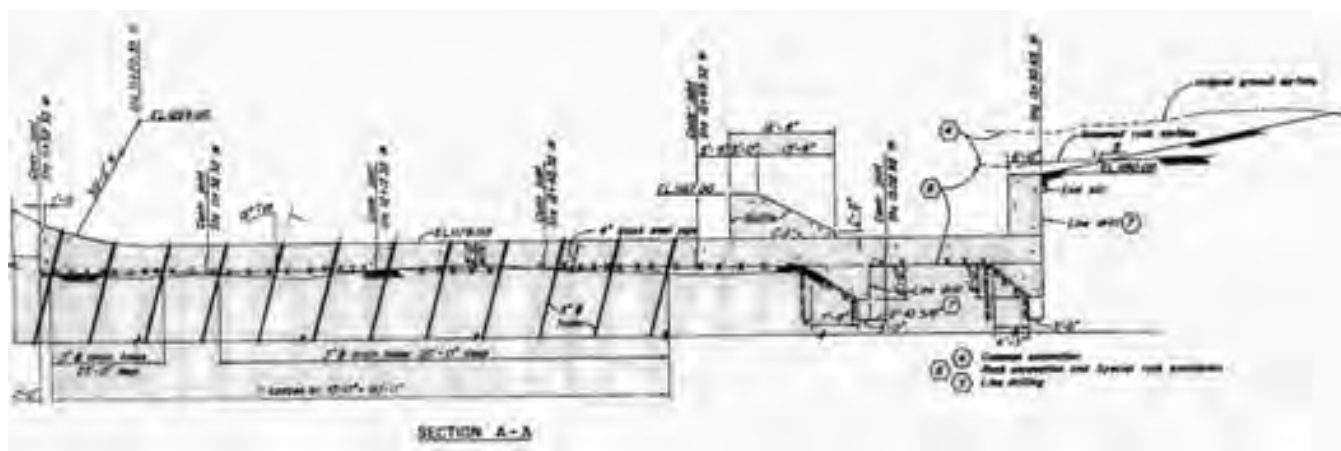

Figure A-36.—Stilling basin profile.

adjacent areas. Three-inch drainholes spaced on 10-foot centers in each direction are provided upstream of the baffle piers. These drains are 20 feet deep over the entire stilling basin except at the upstream end where three rows of drainholes are 25 feet deep.

The stilling basin was constructed of concrete with a 28-day compressive strength of 3,000 lb/in<sup>2</sup>. The top of the slab is at elevation 1179.0 feet and the top of the end sill at elevation 1190.0 feet. The slab was designed for 50 percent relief of maximum uplift pressure due to the hydraulic jump under design flood spillway discharge and is anchored to engage foundation rock to a depth sufficient to resist the unrelieved uplift force. The baffles were designed and anchored to be stable against the full impact force of the design flood spillway discharge jet. The end sill was designed for the force of the jet passing between the baffles. The stilling basin was first used in March 1963 when the stream was diverted through lowered monoliths 8 and 10 to begin second stage construction. Flow through the sluices began October 1964 when final closures were made, and normal operation of the dam began on 15 December 1965 with the final acceptance of the project by the construction engineer.

The spillway was designed for a maximum discharge of 140,000 ft<sup>3</sup>/s and a maximum velocity of 108 ft/s. The spillway has operated, but releases were small due to control by the tainter gates. The maximum discharge of record came during June 1972 when 24,800 ft<sup>3</sup>/s was discharged through the sluices. The maximum velocity at the sluice exit was 88 ft/s with the upper pool at elevation 1362.12 feet.

Because of the proximity of a pumped storage power plant on the left abutment and problems from spray, especially during the winter months, the right side sluices were used most of the time. Use of these sluices caused a circulatory current that carried

debris into the stilling basin. The end sill being below streambed level contributed to the deposition of debris in the basin.

As early as September 1969, less than 4 years after the stilling basin had been placed into normal operation, damage to the stilling basin floor had been reported by divers.

A later dive inspection using an electronic depth indicator verified the presence of holes and abrasion erosion as well as piles of rock, gravel, and other debris. The rock and gravel fragments were found to range from sand size to 8 inches in diameter. Most of the damage was at the contraction joints and the corners of the baffles. Scour holes were up to 42 inches deep.

In November 1972, an attempt to remove the debris by the use of a trash pump was not very successful because of the large size of some of the stone. A long-boom truck crane with a clamshell was brought in and was used to remove about 50 yd<sup>3</sup> of gravel, rock, and metal. Placing the truck crane on the right bank training wall required the construction of a 200-foot long road from the toe of the dam embankment.

A contract was awarded, and repairs were started in July 1973. The plans called for accomplishing the work in two stages using cellular cofferdams that would enclose about 60 percent of the stilling basin for each stage, permitting stream flow in the unobstructed part of the stilling basin. The cofferdams were pumped out at a rate not exceeding 9 inches/hour of water surface drop, and fish entrapped within the cofferdam were removed.

Damage to the stilling basin floor was most noticeable in the area downstream of sluices 4 and 5 ([figure A-37](#)). The two rows of slabs adjacent to the left training wall had generally minor surface abrasion erosion with a maximum depth of approximately 6 inches. A large, donut-shaped hole ([figure A-38](#)) extended over four slabs downstream of sluices 4 and 5 and had a maximum depth of about 42 inches. Abrasion erosion was generally deeper at the joints. Damage to the baffles was generally confined to the baffles in the middle of the basin (3 through 7) with baffles 1, 2, 7, and 8 relatively undamaged. Reinforcing was exposed over approximately two thirds of the upstream face and partially around the corners of the baffles in the worst cases ([figure A-39](#)). All faces of the baffles had eroded to varying degrees. The toe of the spillway section was eroded to a maximum depth of 4 inches from the floor of the stilling basin up to approximately elevation 1192.5 feet.

In preparation for the repair, the floor of the stilling basin was cleaned by wet sandblasting. Loose, weak, or deteriorated concrete was removed by chipping all loose materials and impurities were then removed by washing or wet sandblasting, and No. 8 dowels were installed on approximately 3-foot centers. The deeper holes were partly filled with concrete having a 28-day compressive strength of 3,000 lb/in<sup>2</sup>.





Figure A-37.—Abrasion erosion of the stilling basin slab.



Figure A-38.—Abrasion erosion of stilling basin slab. Note the constructed cellular cofferdam that encloses a portion of the basin.



Figure A-39.—Baffle pier damaged by abrasion erosion.

Prior to placement of the fibrous concrete, a trial mix was made at the batch plant to approve the suitability of the operation. Two 1-yd<sup>3</sup> batches of mixtures proportioned to have fine to coarse aggregate ratios of 3 to 1 and 3 to 2, respectively. Each batch contained 200 lb of thin, flat steel fibers 1-inch in length and was proportioned for 28-day compressive and flexural strengths of 6,000 and 1,100 lb/in<sup>2</sup>, respectively. Based on this trial, the 3 to 2 ratio mix was recommended for use in the repair work. In addition, it was recommended that 7-yd<sup>3</sup> batches be mixed in a 10-yd<sup>3</sup> capacity ready-mix truck. The batching sequence was sand, crushed limestone coarse aggregate, steel fibers, cement, and water.

The previously described procedure was used at the start of placing fibrous concrete with water added at the job site. However, these batches contained excessive “balls” and had to be rejected. The procedure was adjusted to add all the ingredients at the batch plant. The fine and coarse aggregates were placed in the mixer, and approximately 70 percent of the mixing water was added. The steel fibers were added next, using a high speed conveyor at a nearly continuous rate. All the cement was then charged into the mixer and the remaining water was added to the batch prior to transporting it to the job site. Balling of the batches was thus eliminated or reduced to a point where the balls could be removed. Six cubic yards were batched in a 10 yd<sup>3</sup> capacity transit mixer.

A high modulus epoxy bonding compound was placed on the stilling basin floor immediately prior to placement of the fibrous concrete overlay. The overlay was placed in slab sections conforming to the original slabs. Slab placement was in alternate sections starting at the upstream end of the row adjacent to the left training



Figure A-40.—General view of repair operations.

wall (figure A-40) and proceeding in adjoining rows to the center of the stilling basin. Relief drains were extended through the overlay. Approximately 1,400 yd<sup>3</sup> of fiber concrete was required for the overlay, which was placed to elevation 1180.0 feet, 1-foot higher than the original stilling basin floor from the toe of the dam to a point just short of the downstream end of the baffle piers.

The baffles were prepared for repair in the same manner as the stilling basin slab. Dowels were installed and an epoxy bonding compound applied. The front of the baffles was resurfaced with fibrous concrete and reinforced with No. 8 steel bars. In addition, corner pieces of corrosion-resistant steel plate,  $\frac{5}{8}$ -inch thick, were installed at the upstream corners of the baffles. Both of the sides, the top, and the back of damaged baffles were coated with an epoxy mortar. This same mortar, a 1 to 1 ratio of epoxy and silica sand, was used to coat the damaged spillway surface to a  $\frac{1}{2}$ -inch average thickness.

The only major difficulty encountered during the repair work was that of installing a cofferdam of sheet pile cells while a stream flow was maintained. A minor problem resulted during repairs when the 1-inch long steel fibers used in the fibrous concrete had a tendency to ball. When some of the water was added to the mix before the introduction of the steel fibers, however, this balling tendency was greatly reduced.

The preflooding inspection of Stage I was made on October 25, 1973 and for Stage II on August 29, 1974. All work was completed by the contractor on October 25, 1974 at a total cost of \$1,714,987. Approximately \$734,000 of this total was for construction of cofferdams required to unwater the structure.

The initial diver inspection of the repair in November 1974 indicated minor concrete deterioration on some of the baffles and in the surrounding floor area. Two large areas of epoxy repairs at the base of the spillway were missing. An estimated 45 yd<sup>3</sup> of debris was removed from the basin. At that time, an experiment was conducted to determine whether currents and eddies carried material back from the channel downstream of the stilling basin and over the end sill into the stilling basin.

Approximately 5,500 bricks of three different types were dropped from a boat into the river and were distributed downstream of the basin. Six days after the placement of the bricks, the stilling basin was inspected by two divers who found innumerable smooth pieces of all three types of brick in various sizes.

In April 1975, additional concrete abrasion erosion was noted on five baffles and in the floor area between and downstream of the baffles. Trenches around some baffles had approximate maximum depths of 4 to 12 inches. The stilling basin floor upstream of the baffles contained several areas of abrasion erosion in the recently completed fiber-reinforced concrete overlay. Numerous No. 8 dowels were exposed in vertical heights from about 1 to 13 inches, indicating depths of abrasion erosion in these areas to be approximately 5 to 17 inches deep. Additional areas of epoxy repairs at the bottom of the spillway were missing. Approximately 45 yd<sup>3</sup> of debris was removed from the stilling basin. Included in this debris were numerous pieces of all three types of brick previously deposited in the river. The original bricks had been worn or broken into small pieces of various sizes and had been rounded smooth. This proved beyond any question that scouring material was being brought into the stilling basin from areas downstream of the end sill.

Downstream of the end sill and a pile of debris at the right training wall, the divers located a trench in the riverbed rock adjacent to and parallel with the right training wall during the May 1975 inspection. This trench, which was about 10 feet wide and 2 to 3 feet deep, extended downstream beyond the end monolith 26 in a meandering direction. About five or six new dished holes in the concrete were located in the second and third rows of floor slabs downstream between sluices 7 and 8. The largest of these new holes was about 2 feet in diameter and had a maximum depth of about 14 inches. Approximately 60 yd<sup>3</sup> of debris was removed from the stilling basin. All sluices were recommended to be operated symmetrically, despite any objections from the pumped-storage power plant representatives. This policy was placed in operation. Additional concrete abrasion erosion in the stilling basin was noted during the September 1975 inspection, but the rate of deterioration had decreased considerably. There was increased abrasion erosion of the original concrete flooring downstream of the baffles, exposing approximately 90 rebars. The two piles of debris found in the stilling basin were estimated to contain about 20 yd<sup>3</sup>, which was approximately the estimated amount of debris left inside the stilling basin after the cleanout in May 1975, as the crane could not reach the center area between the training walls. This material was removed in November 1975, and the basin was reported to be clear of debris. As a result of sluice experiments, a table outlining the sluice operating procedure for a range of outflow was prepared.



No piles of debris were found on the stilling basin floor during the January 1976 inspection. The only debris was located in some existing scour holes. The scour holes located upstream of the baffles in the fiber concrete went down to or continued into the original concrete below. Many of the No. 8 dowels were exposed from about 1-inch up to a maximum of about 18 inches. Soundings were taken along the deepest parts of the 10-foot wide trench in the bedrock adjacent to the right training wall. The approximate elevation at the deepest part was 1177.7 feet. There was no undercutting of the two downstream monoliths 25 and 26, which had a final grade between elevations 1173.3 to 1171.3 feet. Additional tests of various symmetrical sluice operations with different gate openings were conducted. The power plant added a series of heat lamps to the electrical equipment installed on top of the roof to help prevent the insulators from becoming covered with ice.

No piles of debris were found on the stilling basin floor in either the April or September 1976 inspection. The only debris was located inside existing scour holes in the fiber concrete overlay, mainly in the first three floor slabs downstream from and between sluices 3 and 8. Similar conditions were noted at the last inspection, but the debris was not removed from the basin. The debris consisted of smooth stones, ranging from about 1-inch diameter to about fist-sized pieces of epoxy that had broke away from repairs to the lower portion of the downstream face of the spillway, and a few riprap, the largest measuring 8- by 6- by 18-inch long. These riprap stones had apparently been thrown into the stilling basin by visitors at the project. In the first row of floor slabs downstream from and in front of sluices 6, 7, and 8, the concrete floor surface had deteriorated to a greater extent in September 1976 and had become wavier than was previously reported. With this exception, there appeared to be no additional concrete deterioration of the stilling basin floor, the baffles, and the end sill since the inspection of September 1975. The conditions downstream of the sill appeared to be about the same as those found during the inspection of January 1976.

A diver inspection in June 1977 indicated fiber concrete in the basin slab had eroded to a maximum depth of 36 inches. During a similar inspection in October 1978, divers removed approximately five wheelbarrow loads of miscellaneous debris, most of which appeared to have been tossed into the basin by visitors. Although a number of the No. 8 dowels were still exposed, this was the first inspection that failed to locate any sheared dowels within the basin since the repair. Major abrasion erosion of the fiber concrete was concentrated in the first two rows of slabs immediately downstream of the spillway. The deepest abrasion erosion (42 inches) occurred in the second floor slab downstream of sluice 7. The next deepest abrasion erosion (29 inches) was located in the second floor slab downstream from and to the right of sluice 5. A debris trap has subsequently been installed as shown in [figures A-41](#) and [A-42](#).

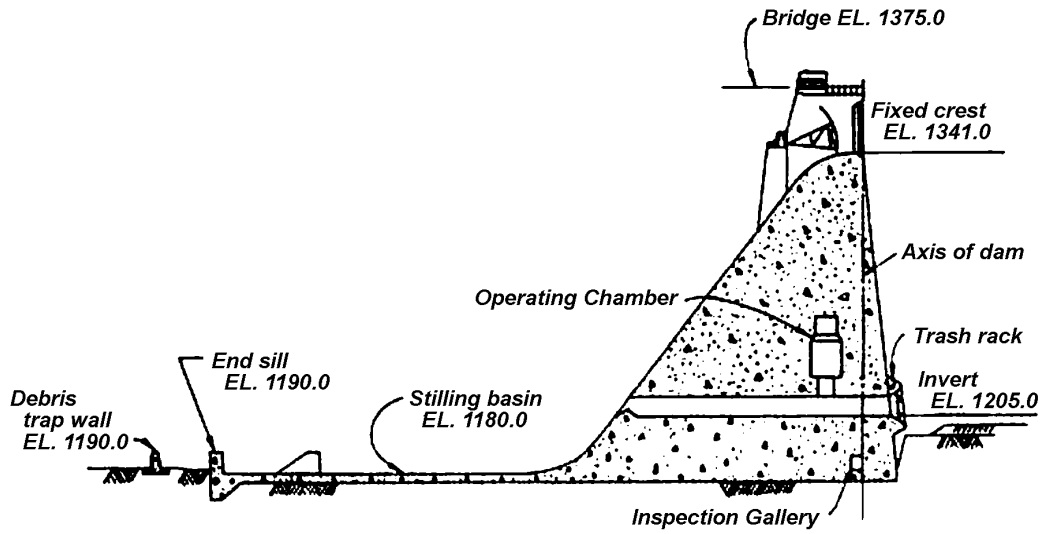

Figure A-41.—Stilling basin profile with debris trap.

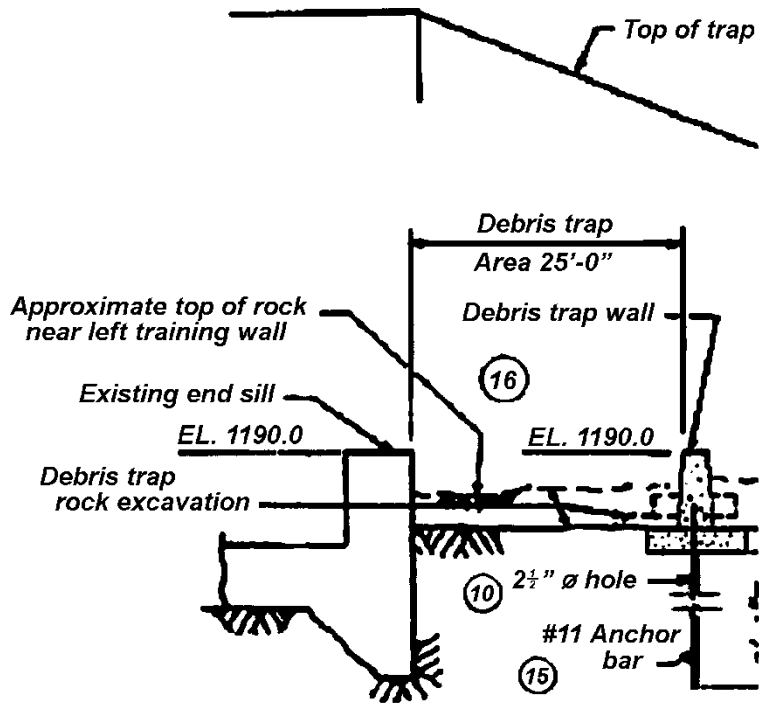

Figure A-42.—Details of the debris trap.



Kinzua Dam pulled debris into the basin from both an unbalanced operation of the sluice gates and having a downstream channel about the same height of the end sill. Although having balanced flow releases reduced the debris being pulled in the basin, the high downstream channel still led to debris being pulled into the basin. Current USACE guidance recommends the downstream channel be below the end sill to allow for a roller to form downstream from the end sill without pulling debris back into the basin.

Rehabilitation of the stilling basin had been completed in 1983. The repair method included the placement of a maximum one foot thick overlay of silica fume concrete in the basin floor and a debris trap defined by a reinforced concrete end wall (figure A-42). Annual diver inspection indicates that the deterioration of the stilling basin is continuing at a slow rate. The condition will continue to be monitored annually.

Diver inspections in 2000 and 2002 noted no significant change in the basin condition from other dive inspections conducted since at least 1993 and there was minimal debris in the basin. The concrete floor was generally in good condition with minor erosion, less than 8 inches deep, present at some joints. There was also random cracking throughout the basin floor, minor deterioration of the baffles, and minor deterioration at the toe of the dam. Undercutting of the upstream face of the debris trap end sill wall, ranging from 6 inches to a maximum of 18 inches in select areas, primarily near the left training wall, was noted in an August 1996 diver's inspection. Investigation of the undercutting in subsequent divers inspections has been difficult, as the areas have generally been filled with debris. The 2002 divers report noted spot undercutting of the upstream face up to 1-foot deep.

**Lessons learned:**

Kinzua Dam pulled debris into the basin from both an unbalanced operation of the sluice gates and having a downstream channel about the same height of the end sill. Although having balanced flow releases reduced the debris being pulled in the basin, the high downstream channel still led to debris being pulled into the basin. Current USACE guidance recommends the downstream channel be below the end sill to allow for a roller to form downstream from the end sill without pulling debris back into the basin.

**References:**

U.S. Army Corps of Engineers, *Maintenance and Preservation of Concrete Structure*, TR C-78-4, April 1980.

## Outlet Works Energy Dissipators

---

U.S. Army Corps of Engineers, *Engineering and Design: Evaluation and Repair of Concrete Structures*, Engineer Manual 1110-2-2002, June 30, 1995.

**Project:** Lucky Peak Dam

**Location:** Idaho

**Summary:** Problems with flip bucket operation

Lucky Peak Dam, located 10 miles from Boise, is a rolled earthfill dam and was completed in 1955 (figure A-43). The dam is 2,340 feet long and 340 feet high. The storage capacity of the reservoir is 300,000 acre-feet. The reservoir is 12 miles long with 45 miles of shoreline. The outlet works is located in the left abutment. The original outlet works had a diameter of 23 feet with six 5-foot 3-inch by 10-foot slide gates and a 30-inch diameter hollow-jet valve. Emergency slide gates (10-foot by 23-foot Broome type gates) are provided at the intake tower. The outlet works has a maximum discharge capacity of 28,500 ft<sup>3</sup>/s with 228 feet of head. A 600-foot long concrete ogee crest free-overflow spillway is located on the left abutment. The spillway has never operated.



Figure A-43.—Aerial view of Lucky Peak Dam. The arrow denotes the location of the six slide gates and flip buckets.

## Outlet Works Energy Dissipators

---

The dam was originally built with one intake structure, outlet conduit, and outlet structure with the potential for future hydropower. Discharge flows from the six bay outlet structure through six slide gates. Flows released through the slide gates enter six flip buckets where the free falling high velocity flow is directed downstream into an unlined plunge basin (approximately 80 in depth). The single outlet works proved to be inadequate because no water could be released when the outlet works were taken out of service for inspection and maintenance. A second (auxiliary) outlet works was built for the construction of the power plant that was completed in 1988. Construction included a bifurcation of the original outlet conduit to supply water to the powerhouse. The maximum discharge capacity through the power plant is 7,600 ft<sup>3</sup>/s. Construction of the power plant eliminated most of the operation required through the original outlet structure.

No water is released from Lucky Peak Reservoir solely for the purpose of producing electricity. Power is produced primarily from April—October when flood control and irrigation needs require releases of water. Minimal power production is possible during the other months. When water flows over the flip buckets, this creates a popular unique and unusual water display (rooster tail) for the public (figure A-44). The water used to create the display comes from flows in excess of what is needed for power generation at full capacity. The “rooster tail” discharge comes through the outlet works slide gates and enters a flip bucket, which sends the water dozens of feet into the air, creating an arch of spray into the Boise River (figure A-45). The display does not operate every year due to lack of available water. The “rooster tail” has been observed reaching heights up to about 150 feet. Flow directed downstream by the flip buckets has resulted in significant water vapor being created (figure A-46)



Figure A-44.—Discharge emerging from flip bucket operations.





Figure A-45.—High velocity flow being directed downstream into the plunge basin.



Figure A-46.—Operation of the flip bucket caused significant icing due to water vapor.



**Figure A-47.**—Discharge from the upstream slide gate resulted in significant cavitation damage to the invert of the flip bucket.

which drifts across the river channel. During the colder months this spray causes icing on a nearby highway.

From initial operation, the slide gates and flip buckets were plagued by high maintenance and cavitation damage (figure A-47). Excessive erosion on the bottom of the channel and the sides near the bottom of the gates openings occurs at gate opening less than two feet. Cavitation is caused by the high velocity of the water exiting from the gates, which can approach 120 feet per second. Concrete repairs and eventual armoring of the flip buckets with steel lining was required. Bays 1 through 4 were steel lined as a result of frequent use. Bays 5 and 6 were not steel lined since they were the least used. The flip buckets typically receive enough cavitation damage in a single season to require repairs. The cavitation would cause “honeycombing” in the stainless plate to a depth of as much as  $\frac{3}{4}$ -inch in a single season of use. Additional modifications included altering the angle of the lip of the flip buckets and the installation of air vents. Operation of the slide gates is now kept to a minimum, so they are seldom used.

Over the years, operation of the flip buckets caused the development of a small gravel bar downstream from the plunge basin.



**Lessons learned:**

Because of the amount of energy to be dissipated, this type of outlet works energy dissipator tends to be high maintenance, if used continuously.

**Reference:**

Phone conversation with Mr. Tom Nelson, Lucky Peak Power Plant Project, January 2009.

**Project:** Mason Dam

**Location:** Oregon

**Summary:** Stilling basin flow deflector

Mason Dam is located in east-central Oregon on the Powder River, approximately 17 miles southwest of Baker City, Oregon. The zoned earth and rockfill embankment was completed in 1968. The dam is 173 feet in height, 895 feet in length at a crest elevation of 4082.0 feet, and has a 35-foot wide crest. Figure A-48 shows the downstream face of the dam. Appurtenant structures at the dam consist of a spillway and an outlet works.

The outlet works passes through the left abutment and consists of a tower intake structure with a sill elevation of 3975.0 feet, a 6.5-foot diameter upstream circular tunnel, a gate chamber containing a 48-inch square high pressure emergency gate, a 8.75-foot diameter modified horseshoe downstream tunnel housing a 56-inch diameter steel pipe, a control structure housing two 33-inch square high pressure regulating gates, a type II stilling basin, and a discharge channel. The design discharge capacity of the outlet works is 880 ft<sup>3</sup>/s at reservoir water surface elevation 4077.25 feet. However, releases have been limited to about 450 ft<sup>3</sup>/s to prevent damage to the stilling basin and exceeding the downstream channel capacity.

The outlet works stilling basin at Mason Dam has had a long history of abrasion erosion damage and repeated repairs and was determined to be an excellent candidate for a field installation of a flow deflector. A physical model study was



Figure A-48.—Mason Dam as seen from the left abutment.

conducted to evaluate the hydraulic characteristics of the stilling basin and to design a flow deflector for the purpose of mitigating basin abrasion damage.

A 1:7 geometric scale was used to model the Mason Dam outlet works stilling basin. Froude scale similitude was used to establish the kinematic relationship between model and prototype because hydraulic performance depends predominantly on gravitational and inertial forces. Froude scale similitude produced the following relationships between the model and the prototype:

$$\begin{aligned}\text{Length ratio } L_r &= 1:7 \\ \text{Velocity ratio } V_r &= L_r^{1/2} = 1:2.65 \\ \text{Discharge ratio } Q_r &= L_r^{5/2} = 1:130\end{aligned}$$

A physical model was used to study the effect of deflector angle and position on flow patterns over the basin end sill (figure A-49).

Prototype features modeled included:

- The two 33- by 33-inch high pressure regulating gates and upstream bifurcation.
- The 17-foot wide hydraulic jump twin bay stilling basin with 2:1 sloping chutes, and dentated end sill.
- Approximately 75 feet of topography downstream from the basin, constructed on a 5:1 slope.

Velocities were measured with a SonTek Acoustic Doppler Velocimeter (ADV) probe and were measured at the downstream end of the basin at its centerline. Tailwater elevation was set for each flow condition tested, using tailwater data obtained during Mason Dam outlet works operations. The deflector was modeled with a flat section of sheet metal spanning the 17-foot wide basin and mounted on guides attached to the basin sidewalls, to allow vertical movement of the deflector within the basin (figure A-50).

Model investigations were conducted to evaluate hydraulic conditions in the stilling basin and downstream apron area for the range of operating conditions expected in the prototype. Both high pressure regulating gates of the twin bay design were operated symmetrically at all times as required by the operating procedures at the dam. Velocity data and dye streak data were collected and analyzed to define basin performance. This data was used to determine the most effective deflector angle and the best lateral and vertical locations within the basin. Although investigations were



Figure A-49.—Looking through the plexiglass sidewall of the model operating at 40 percent gate opening.



Figure A-50.—Looking upstream at stilling basin model with ADV probe and deflector installed near the end of basin.

conducted up to the maximum possible discharge of 870 ft<sup>3</sup>/s (100 percent gate opening at maximum reservoir, elevation 4077 feet), the optimum deflector design was based only on discharges up to 575 ft<sup>3</sup>/s (60 percent gate opening at maximum reservoir), due to the discharge limitations in place. Velocities were measured at numerous locations within and downstream from the stilling basin to map out resulting hydraulic flow patterns for each discharge tested. Initial measurements included mapping vertical velocity profiles measured at the downstream end of the stilling basin for gate openings of 20, 40, 60, 80 and 100 percent, with discharge based on maximum reservoir.

Velocities were measured at approximately 0.7-foot vertical increments starting 0.29 feet above the basin invert and continuing until air entrained in the flow prevented further measurements (all dimensions are prototype). Early investigations showed that average velocities measured at the end of the basin, at its centerline, and 0.44 feet above the invert elevation provide a good representation of the bottom velocities that carry materials into the basin. Therefore, velocities measured at this location were used as a basis to determine deflector performance for all subsequent investigations. In addition, 8 piezometer taps were installed equally spaced across the upstream and downstream faces of the deflector. The taps were connected to a manometer board to measure differential loading on the deflector for flow rates up to a maximum discharge of 870 ft<sup>3</sup>/s at 100 percent gate opening.

Tests were initially conducted at 40 and 60 percent gate openings only, since these conditions produced the strongest upstream bottom velocities adjacent to the riprap apron, within the maximum operating range specified by the Mason Dam operating procedures. Four different parameters were investigated to determine what criteria would produce the best deflector performance (all parameters are referenced to the bottom upstream edge of the deflector):

- *Lateral and vertical positioning.*—Initial investigations were conducted with a 5-foot high deflector, angled at 60 degrees and spanning the width of the basin. Lateral location was defined as the distance from the downstream end of the stilling basin (defined as the downstream end of the basin sidewalls) to the deflector. Lateral locations were varied from 0 to 14 feet. The best position for the deflector laterally along the length of the basin was determined by setting the deflector a specified distance from the end of the basin and then measuring average bottom velocities at the end of the basin. For each lateral position, the deflector was moved in vertical increments so that average bottom velocities could be measured for a range of deflector elevations for each flow condition tested. Deflector elevation was varied from 4 to 15 feet above the elevation of the basin floor (floor elevation 3889 feet).

Deflector performance was defined by comparing these velocities, that is, the higher the velocity in the positive direction, the better the performance.

Positive values indicated that average velocity was in the downstream direction, away from the basin.

- *Angle.*—Once the most effective range for lateral and vertical positioning was established, deflector angle was varied to determine best performance. For this case, lateral positioning was kept constant at 5 feet and deflector elevation was varied from elevation 3896 to 3901 feet. Velocities were measured for deflector angles ranging from 40 to 90 degrees referenced from the horizontal plane.
- *Size.*—The next step was to determine if the deflector could be reduced in size in order to reduce costs and still maintain performance. For this set of tests, deflector lateral positioning was kept constant at 5 feet and deflector elevation was kept constant at elevation 3900 feet. Deflectors 3 feet and 4 feet in height were tested at 80 and 90 degrees. After some discussion, it was determined the additional cost was insignificant compared to the increased confidence level in performance, and therefore the 5-foot deflector was selected for the final design.

As a result of these investigations, it was determined that best deflector performance, based on average bottom velocities measured at the downstream end of the basin, occurred with a 5-foot high deflector mounted 5 feet upstream from the end of the basin at elevation 3900 feet (11 feet above basin floor) and angled at 90 degrees.

Piezometer taps installed on the upstream and downstream faces of the model deflector were used to measure differential loading. The maximum loads predicted for the prototype deflector were 6,000, 12,000, and 12,600 pounds, respectively, for basin operations of 60-, 80-, and 100-percent gate openings.

After the optimal design parameters were set, it was important to look at deflector performance with the basin operating throughout the full range of possible discharges up to the maximum flow at 100 percent gate opening, in case unusual circumstances should require releases above those normally allowed while the deflector is in place. With the optimal deflector design in place, performance at gate openings ranging from 20 to 60 percent was very good. Average velocities for this range of discharge were greater than 1.0 ft/s and were directed in the downstream direction.

Further testing demonstrated that performance at higher discharges can be significantly improved by moving the deflector to a lower elevation. This could be accomplished with a mobile deflector supported on guides to allow vertical adjustments in position for operations at high and low discharges. However, since the outlet works will probably never be operated at these higher releases due to operating limitations at the dam, the stationary deflector design positioned at elevation 3900 feet was determined acceptable.



Model investigations showed that without a deflector, materials can be flushed from the basin throughout the range of operations tested, due to the nature of the flow occurring within the basin. This phenomenon occurs because turbulence within the basin periodically tosses materials high enough into the water column to be caught and subsequently carried out by the main jet exiting the basin. However, these suspended materials often hit their fall velocity as they are exiting the basin and are deposited back onto the basin end sill; thereby making them readily accessible to be carried right back into the basin by the upstream current. As a result, for a large range of discharges, although materials are flushed out, the inflow of materials is constant, thereby resulting in significant abrasion damage.

With the optimal deflector design in place, model investigations demonstrated that the upstream component of velocity at the end of the basin is no longer strong enough to carry a significant amount of material back into the basin; therefore most materials that are flushed from the basin will not be carried back in. As a result the basin potentially becomes hydraulically self-cleaning, thereby reducing abrasion damage significantly. The range of sizes of materials that can be flushed from the basin will depend on outlet works operations and will be determined more precisely in future studies.

The final prototype deflector for Mason Dam was designed with a set of guides that would allow the deflector to be manually adjusted in angle and elevation for testing purposes. The prototype flow deflector was delivered to Mason Dam and installed in October of 2002 ([figure A-51](#)). In addition, basin abrasion erosion damage was repaired with new concrete at the time the deflector was installed. In April of 2003, the deflector was set to optimal position as determined from the model study before seasonal operations began.

In August 2003, after nearly 5 months of basin operations with the deflector in place, a field evaluation and dive inspection were conducted to verify the effectiveness of the deflector.

An Acoustic Doppler Profiler probe was installed by a dive team to measure exit velocities at the downstream end of the basin. The deflector was raised above the water surface and basin exit velocities were measured for outlet works operations ranging from 10 percent gate opening up to 60 percent gate opening at 10 percent increments. The same measurements were repeated with the deflector lowered to optimal position, with bottom elevation set to elevation 3900 feet and angled at 90 degrees.

Divers conducting the initial underwater inspection in August 2003 found only a few small stones in the basin and noted that the new concrete was very smooth and in excellent condition, with no signs of any abrasion erosion or wear. A second dive inspection of the stilling basin was conducted in August 2004 after a second season



Figure A-51.—Prototype flow deflector installation at Mason Dam in October 2002.

of operations with the deflector in place. Again, the divers found only a few small stones (total of 4) throughout the entire basin. However, in addition they discovered that a thin layer of the new concrete (used to repair the basin in October 2002) was gone, exposing aggregate at its surface.

After spending some time examining photos of the basin floor and consulting with concrete experts and divers who had conducted similar inspections, it was concluded there was no indication that the cause of the missing layer was due to abrasion erosion. Several factors were cited as probable causes of this phenomenon including the fact that the concrete was exposed (despite an effort to protect it with a layer of hay) to temperatures well below freezing (5 °F) immediately following the laying of the new concrete. This likely caused the top layer to freeze before it had time to cure, thereby creating a weak top surface. In addition several dive team members had seen similar surfaces at other sites where there were no signs of abrasion erosion damage or rocks in the basin, and erosion did not progress further in subsequent years.

A third dive inspection, conducted June 2005, showed no signs of abrasion damage and only a few stones in the basin, thus providing further evidence the deflector was performing as desired.

### **Lessons learned:**

#### *Model tests:*

Results from model investigations indicate that the installation of a flow deflector in the stilling basin can help improve flow conditions to minimize the potential for carrying materials into the basin, thereby extending basin life, and reducing long-term O&M costs.

Model investigations were used to design an effective flow deflector for discharges up to the maximum downstream river channel capacity of 500 ft<sup>3</sup>/s, maximum discharge allowed by operating procedures at the dam.

The investigations determined that the optimal deflector design was a 5-foot high deflector positioned 5-foot upstream from the end of the basin at elevation 3900 feet (referenced to the upstream lower edge of the deflector) and angled at 90 degrees (vertical).

The 5-foot high deflector spanning the 17-foot wide basin produced better performance than a 3 or 4-foot high deflector. However, performance was acceptable for all three configurations.

Without a deflector in the basin, the average bottom velocities measured at the end of the basin were predominantly in the upstream direction and ranged in magnitude

from -0.4 ft/s to -0.8 ft/s for gate openings ranging from 20 to 100 percent (negative values indicate velocities were upstream into the basin). Maximum upstream velocities measured were in the range of -2.0 ft/s to -3.0 ft/s. All dimensions and measurements reported here are scaled to prototype dimensions.

With the optimal deflector design in place, average velocities were directed downstream away from the basin. Maximum downstream bottom velocities measured at the end of the basin ranged from 3.0 ft/s to 5.0 ft/s for the range of operations tested. Velocities of this magnitude should not cause any significant erosion downstream from the basin.

Model investigations indicated that with a deflector installed in the basin, flow releases ranging from 30 to 60 percent gate opening can be used to flush materials from the basin. Without a deflector, releases at 100 percent gate opening (870 ft<sup>3</sup>/s) are required to purge materials from the basin. However, since this exceeds the maximum downstream river channel capacity of 500 ft<sup>3</sup>/s and Standing Operating Procedures requirements, releases at 100 percent gate opening are not normally allowed. Therefore the basin cannot be flushed regularly without a deflector. The exact size of materials that can be flushed from the basin with the deflector in place will depend on operations and have not yet been determined.

The difference in water surface profiles measured along the basin walls, with and without the deflector installed, was negligible.

Piezometer taps were used to measure the differential loading across the deflector for model operations up to 100 percent gate opening at maximum reservoir elevation. The maximum force on the prototype deflector due to static hydraulic loading was predicted to be about 12,600 lb.

### *Field evaluation:*

Average vertical velocity profiles measured at Mason Dam at the exit of the basin without a deflector correlated well with the velocities measured in the model, especially those velocities measured near the bottom where air entrainment was minimal. This demonstrated that the physical model provided an accurate representation of prototype conditions.

Average velocities measured at the basin exit with the deflector in place correlated well with the model for discharge releases up to 30 percent gate opening. Velocities measured at gate openings greater than 30 percent, with the deflector in place, were inconclusive due to high air concentration in the flow that interfered with data acquisition.

The dive team inspecting the basin in August 2004, after two seasons of operations with the deflector in place, found only a few stones in the basin and no indications

of abrasion damage. The flaking off of a thin top layer of the new concrete was attributed to other causes. In June 2005, a subsequent dive inspection was conducted and there were still no signs of abrasion damage; thereby indicating the deflector was performing as desired. In addition, divers found no signs of erosion immediately downstream from the end of the basin.

The high correlation between model and prototype data indicates that the installation of a deflector in the basin can help improve flow conditions significantly to minimize the potential for entraining materials in the basin, thereby extending basin life, and reducing long-term O&M costs.

**Reference:**

Bureau of Reclamation, *Mason Dam Flow Deflectors for Preventing Stilling Basin Abrasion Damage*, Hydraulic Laboratory Report HL-2005-01, October 2005.



**Project:** Mica Dam

**Location:** Canada

**Summary:** Sudden enlargement

Mica Dam (figure A-52) is a hydroelectric dam located about 80 miles north of Revelstoke, British Columbia, Canada. The dam spans the Columbia River and was completed in 1973. The dam was built to a height of 800 feet above bedrock. The Mica powerhouse has a generating capacity of 1,805 megawatts (MW). The dam's underground powerhouse was the largest in the world at the time of its construction.

The principal of sudden enlargements was first used on a large scale in the low level outlet works at Mica Dam in British Columbia in 1967. The design objective was to provide temporary low level outlets while the reservoir was still filling in the dead-storage zone and maintain river flow. The design concern was a potential outlet velocity of 170 ft/s if a significant portion of the 450 feet of head was not dissipated. See [figure 119](#) in the main body of this manual for a design schematic.

One of the two original 45-foot diameter diversion tunnels was used for the outlet works. Two concrete 160-foot long concrete plugs were added. Both plugs would contain with 3 smaller tunnels in which the geometry varies from rectangular to circular. The key feature is the downstream end of plug 1 ([Section CC in figure 119](#)



Figure A-52.—Aerial view of Mica Dam.



in the main body of this manual) where the three 11.5-foot diameter tunnels exit the plug in a converging fashion. Several different shapes were investigated before arriving at the final design. The control slide gate are located upstream of the same plug and would benefit from the backpressures created from the energy dissipation downstream of both plugs. Except for steel housing around the upstream and downstream gates, the tunnels are concrete lined.

The ratio of areal expansion between control tunnels and main expansion is about 20 percent. The maximum release velocity from the control tunnels is estimated to be about 96 ft/s. A design cavitation parameter ( $\sigma$ ) of 3.0 was used as the design guidance. A value of 2.5 was estimated to represent incipient cavitation levels ( $\sigma_i$ ) and 1.0 for incipient damage ( $\sigma_{id}$ ). The cavitation criteria was developed by physical model (1:56.6 scale) tests at the Western Canada Hydraulic Laboratories.

**Lessons learned:**

Model tests with the high head connection were able to verify that the concrete lining in the expansion chambers would not be damaged from cavitation activity.

**Reference:**

Russell and Ball (1967).

## Outlet Works Energy Dissipators

---

**Project::** Navajo Dam

**Location:** New Mexico

**Summary:** Abrasion erosion damage at a hollow-jet stilling basin

Navajo Dam is on the San Juan River in northwestern New Mexico about 34 miles east of Farmington. The dam is a rolled earthfill embankment with a structural height of 402 feet and a crest length of 3,648 feet. The dam contains 26,840,863 cubic yards of materials. The top width of the dam is 30 feet, and the maximum base width is 2,566 feet. Navajo Reservoir extends 35 miles up the San Juan River, 13 miles up the Pine River, and 4 miles up the Piedra River in southern Colorado. The reservoir occupies 15,610 acres, with a total capacity of 1,708,600 acre-feet and an active capacity of 1,036,100 acre-feet. [Figure A-53](#) shows an aerial view of Navajo Dam.

The typical annual reservoir cycle consists of the reservoir being lowered in the summer during the irrigation season, and filled to capacity by the end of the spring. Releases from the reservoir are scheduled to supply downstream water rights, power requirements, fish habitat, and water for irrigation.

The spillway, on the right abutment, consists of an approach channel, concrete crest structure without gates, spillway bridge, concrete chute and stilling basin, and outlet channel. The width of the spillway ranges from 138 feet in the chute section to 195 feet in the stilling basin. The design capacity at maximum water surface



**Figure A-53.**—Aerial view of Navajo Dam. The hollow-jet-valve outlet works basin is located next to the spillway stilling basin.

elevation is 34,000 ft<sup>3</sup>/s. An auxiliary outlet works consisting of a concrete intake structure and a concrete-lined tunnel with gate chamber for two 4-foot-square gates also is located in the right abutment. Flows from the auxiliary outlet works discharge into the spillway stilling basin.

The main outlet works consists of a concrete tower intake structure, an 18.75-foot diameter concrete-lined tunnel, valve house, and a type VIII stilling basin. Control is by one 6- by 13-foot fixed-wheel gate, two 72-inch diameter ring-follower gates, and two 72-inch diameter hollow-jet valves. The valves were tilted downward at 24 degrees to permit the emerging jets to effectively penetrate the basin pool. The outlet works tunnel, located in the right abutment, is 1,603 feet long. Discharge capacity is 4,200 cubic feet per second at an elevation of 6106.6 feet. The first outlet works release was made in 1963.

In the initial model studies conducted in 1957, special attention was given to the excessive tailwater depth, but tests indicated satisfactory operation for the design discharge of 4,200 ft<sup>3</sup>/s through both valves at a maximum static head of 382 feet. Since the major concern was the basin's adequacy to pass the larger diversion flows, a relatively short study of outlet works releases was made. The need for determining the possible damage which might be caused by circulation of abrasive solids in the hydraulic jump was not foreseen. Pressures on the divider wall were measured by open-tube water manometers. There was no indication of the presence of transient hydrodynamic forces which would cause vibration and accompanying structural damage.

The first main outlet works release was made in July 1963. Operation, with one valve 10 to 20 percent open continued until January 1964. Head on the valves varied between 210 feet and 220 feet during that time. The outlet works was shut down in January 1964 and remained closed until May 1, 1964, when one valve was opened 17 percent to permit discharge calibration measurement. From May 23 to June 10, 1964, both valves were operated at equal openings up to 25 percent. Head on the valves increased from 233 to 245 feet in this period. For the first time the jets were observed to penetrate the pool. Operation began with equal valve openings up to 40 percent. This operation continued until August 3, 1964. The reservoir level dropped in this period to where the static head was reduced to 128 feet. During the larger discharges, golf-ball-size gravel was observed in the swirling current.

The valves were closed temporarily to permit inspection of the walls by means of a small boat. The erosion observed through relatively clear water prompted a more thorough examination. On April 17, 1965, an underwater inspection by divers was undertaken. Large quantities of gravel, boulders, and other debris, and extensive damage to the basin walls and floor were discovered. After removal of these materials by means of a clamshell, underwater reexamination disclosed a large cavity about 4 feet deep in the floor of the left bay at the base of the chute. The cavity extended about 4 feet into the face of the concrete-wedge. Other seriously eroded

areas were reported. A decision was made to unwater the basin and make immediate temporary repairs to permit release of the current year's high runoff. Large quantities of loose rock, foreign debris, reinforcement bars, and badly eroded concrete were exposed by the unwatering.

Temporary repair work began immediately to restore the basin floor, walls, and wedges to their original dimensions. Epoxy-bonded concrete and epoxy-bonded epoxy mortar were used to repair the floor. Because of the extreme urgency and the expanse of wall scour, a major portion of which was 2 to 5 inches in depth, those areas were covered with epoxy-bonded pneumatically applied mortar. Permanent modification of the basin would be required to avoid further extensive damage. After the 72-inch diameter hollow-jet valve releases were resumed on May 23, 1965, frequent periodic inspections by divers were made to appraise the effectiveness of the temporary repair. Within 2 weeks, with flows approximating 2,700 ft<sup>3</sup>/s, definite signs of damage were again apparent. Loose rock had again been carried into the basin from the outlet channel. Releases were then increased to maximum capacity of the valves in an effort to sluice out the foreign material. While some was removed, it was observed that the area yielding to erosion had shifted to the downstream portion of the basin. The damage here became successively more severe and soon advanced to a critical state. The bottom of the divider wall at its contact with the floor had undergone severe spalling action evidently due to compression failure induced by intense vibration. On July 10, 1965, the valves were closed for comprehensive evaluation of the basin's condition. Because of operational demands, the 72-inch diameter valves were opened on November 1, 1965, to permit a discharge of 500 ft<sup>3</sup>/s through each for a 3-month period. The emerging jets did not penetrate the basin pool, and no additional damage resulted to the unrepaired basin.

Extensive hydraulic model studies were undertaken to investigate the causes of damage and determine necessary modifications to ensure against damage under the full range of future operation. These studies showed that the original design of the basin, with the converging wedges and center dividing wall, could not be improved upon with respect to efficiency in energy dissipation and stability of the turbulent action. However, the high efficiency produced areas of intense turbulence which caused the basin to be susceptible to damage by the circulation of abrasive materials.

Differential pressures between points on directly opposite faces of the divider wall were measured on the hydraulic model, and an analysis of the distribution of fluctuating pressures was made. Although the differential pressures varied more or less randomly, examination of the record showed several spans of time wherein pressure pulsations of 4 to 7 feet of head were nearly sinusoidal for 4 or 5 cycles. The frequency during these periods was approximately the same as the natural frequency computed for the prototype divider wall, indicating a condition of near resonance for a few cycles. To estimate this effect, it was assumed that a resonant, sinusoidally varying, differential head of 5 feet of water acted on the wall. Assuming a viscous structural damping of 5 percent of critical, computations revealed that in

less than 2 cycles the bending moment in the wall far exceeded that caused by an unopposed full-depth hydrostatic load which was assumed for the initial design.

In the course of model testing, several modifications were made to the original design. These modifications included removal of the converging wedges, testing of several configurations of the divider wall, installation of sloping chutes to increase the degree of impingement of the jets, and improvement of the downstream river channel. Tests made on these model modifications included visual observation of flow conditions in the basin and river channel, observation of the circulation of abrasive material in the basin and the tendency for material to be conveyed into the basin from the downstream channel, recording of instantaneous pressures and vibration on the divider and outside walls, and observation of scour in the outlet channel and abrasion erosion of the basin flow surfaces.

The optimum model modification consisted of complete removal of the converging wedges and center divider wall, installation of 2½:1 sloping chute at the upstream end of the basin, and the addition of 12 inches of additional concrete (prototype thickness) to the inner surfaces of the outside walls and the basin floor. Also, the bottom and side slopes of the outlet channel were paved with an 18-inch thickness of concrete for a distance of approximately 140 feet downstream from the end of the basin (prototype dimensions). The outlet channel improvement also included walls at the tops of the paved slopes to prevent material from entering the channel and a trap at the downstream end of the basin to collect material which might otherwise enter the stilling basin.

Model operation at discharges above 3,200 ft<sup>3</sup>/s at maximum reservoir elevation resulted in strong surging in the basin and high waves in the downstream channel. Because of the absence of a center divider wall, it was found that balanced operation of both valves was necessary for satisfactory stilling basin flow conditions.

Design for modification of the stilling basin incorporated the findings of the model tests. The converging wedges and divider wall were eliminated. A stainless steel-clad plate covers the new, less precipitous chute. A concrete slab extends 137 feet beyond the end sill over the originally riprapped area. The maximum discharge was limited to 3,200 ft<sup>3</sup>/s to ensure tolerable stilling action, and equal valve openings will be required. If an emergency requires operation of one valve alone, strong surging and rapid upstream circulation in the nonoperating side can be expected.

An underwater examination made in 1970 revealed only minor damage and very few rocks in the basin. [Figure A-54](#) shows the modified stilling basin and paved downstream areas. [Figure A-55](#) shows the both hollow-jet valves being operated.

# Outlet Works Energy Dissipators

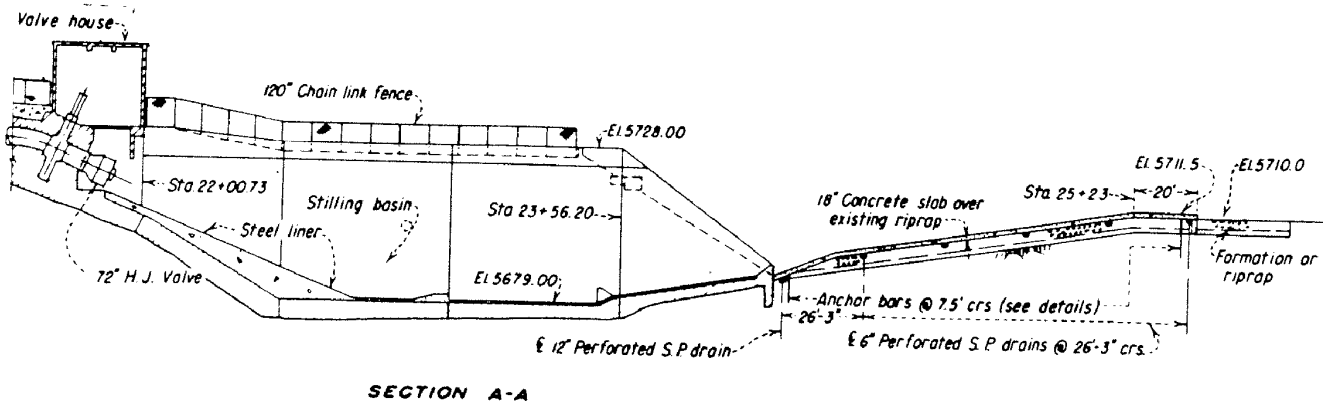
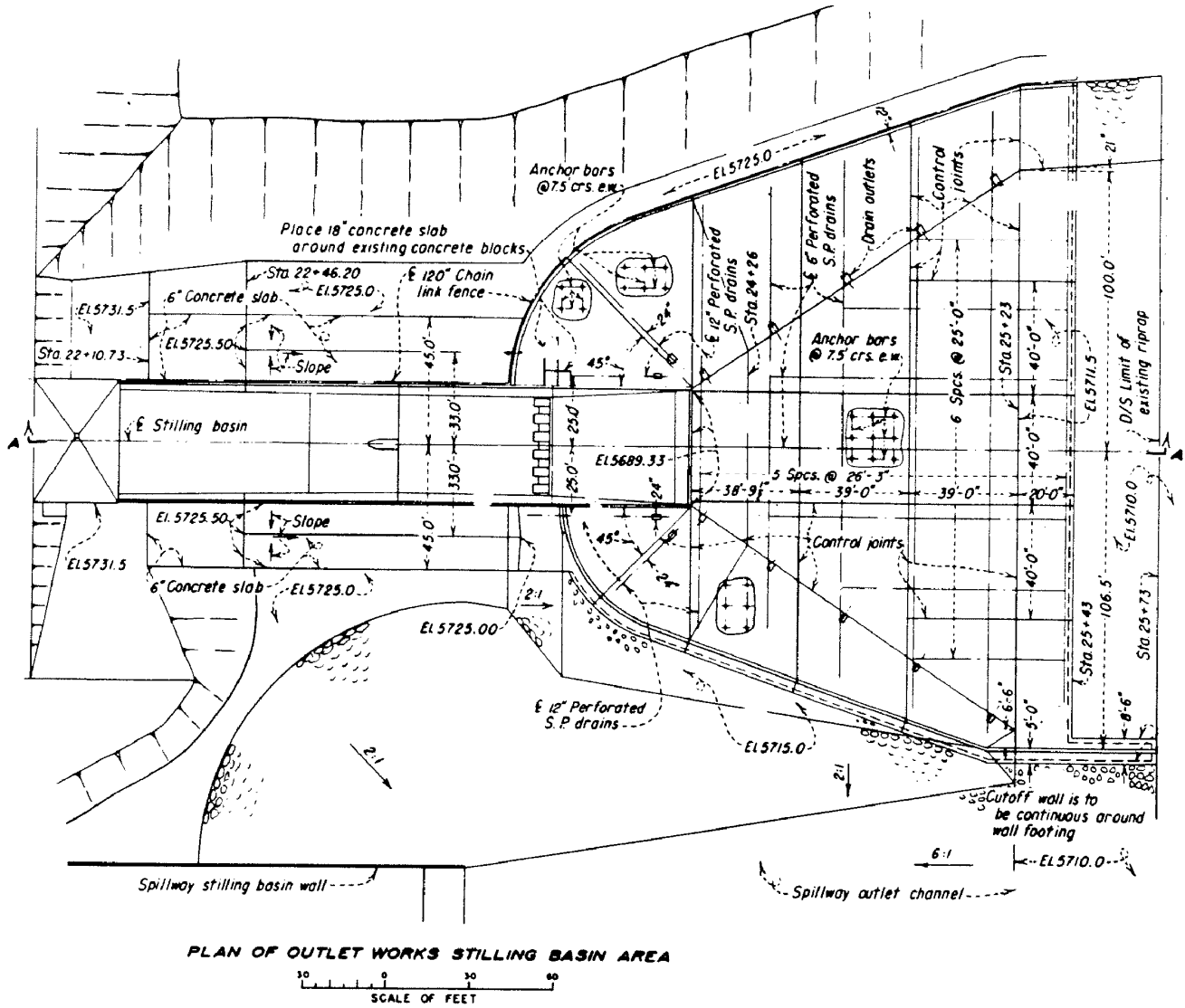

Figure A-54.—Plan and profile of the hollow-jet stilling basin at Navajo Dam.





Figure A-55.—Both hollow-jet valves being operated at near full discharge capacity.

**Lessons learned:**

Initial model studies conducted in 1957 indicated satisfactory operation. However, follow up model studies were required to aid in the design of basin modifications to significantly reduce abrasion erosion and improve flow conditions.

**References:**

Arthur, H.G. and Jabara, Melvin A.; *Problems Involved in Operation and Maintenance of Spillways and Outlets at Bureau of Reclamation Dams*, Question 33—Response 5, Commission Internationale, Istanbul, 1967.

Jansen, Robert B., *Advanced Dam Engineering for Design, Construction, and Rehabilitation*, 1988, p. 712.

## Outlet Works Energy Dissipators

---

**Project:** Nilan North Dam

**Location:** Montana

**Summary:** Replacement of a flared transition type energy dissipator

Nilan North Dam is a 54-foot high earthen embankment located near Augusta, Montana. The dam was completed in 1951. The off-stream reservoir retains 10,092 acre-feet of water behind two earthen embankments (North Dam and East Dam) and is used for irrigation. Each embankment has a 48-inch diameter cast-in-place reinforced concrete conduit. Flows at each dam are controlled with a 48-inch cast-iron sluice gate that is located in a “wet-tower” just upstream from the crest of the dam. The original energy dissipator for the North Dam was a trapezoidal structure that flared from a 4-foot bottom width with vertical side-walls at the upstream end to a 7-foot bottom width with 1.5H on 1V side walls 20 feet downstream. The height of the walls varied from 8 feet to 5 feet over the same distance. The hydraulic performance of the dissipator was very satisfactory for the typical 75 ft<sup>3</sup>/s irrigation releases that it had been historically required to deliver.

By 2000, the energy dissipator on the North Dam was in an advanced state of deterioration with severe cracking and deflection of the right wall (figures A-56 and A-57). The cracking and deflection are believed to be due to excessive soil



Figure A-56.—Original trapezoidal energy dissipator.



Figure A-57.—Deflection in left wall of dissipator.

loading that resulted from poor drainage of seepage flows behind the wall. Irrigation deliveries were subsequently limited until the energy dissipator could be replaced.

The decision was made to replace rather than repair the existing structure due to the advanced state of deterioration. Although the original dissipator performed adequately for the  $75 \text{ ft}^3/\text{s}$  service releases, it was unknown how well it would perform during the higher releases that may be required during an emergency drawdown. The existing outlet and gate system is capable of discharging up to  $350 \text{ ft}^3/\text{s}$  with the gate fully open at the full reservoir pool level. While consideration was given towards designing the energy dissipator for this maximum value, the final dissipator design discharge was selected by sizing it to fit the existing site conditions and verifying that it would provide adequate energy dissipation during an emergency drawdown condition (table A-2). A design capacity of  $150 \text{ ft}^3/\text{s}$  was ultimately selected. A release of  $150 \text{ ft}^3/\text{s}$  is twice the  $75 \text{ ft}^3/\text{s}$  design capacity of the downstream canal, but slightly less than the  $180 \text{ ft}^3/\text{s}$  zero-freeboard canal capacity. Although there is some possibility that releases of  $150 \text{ ft}^3/\text{s}$  would overtop the canal, this was deemed acceptable in the event of an emergency drawdown. The replacement structure design is based upon the NRCS PWD type basin (figure A-58). As compared with the original structure, the headwall height was reduced to 6 feet above the conduit invert, and the side-walls are vertical instead of





Figure A-58.—Replacement structure.

sloped. The replacement structure also has a 2-foot depressed basin and was shortened to 17 feet from the original 20-foot length.

Table A-2.—Estimated and recommended reservoir evacuation times for Nilan North Dam at a maximum release rate of 150 ft<sup>3</sup>/s

Evacuation stage	Nilan North Dam (days)	Recommended time high hazard, significant risk (days)
75% Height	15.2	20-30
50% Height	25.4	40-50
25% Height	31.2	70-90
10% Storage	30.5	50-60

The selected design incorporates the following elements:

- Meets emergency drawdown evacuation criteria as defined by ACER Technical Memorandum No. 3 (USBR, 1990).
- The 150 ft<sup>3</sup>/s design discharge is compatible with the 180 ft<sup>3</sup>/s ultimate (zero-freeboard) capacity of the downstream canal.

- The walls were designed to withstand both earth and full hydrostatic loading in the event that the drainage system should fail.
- Articulated concrete blocks were used as slope and channel bottom protection downstream of the structure in the transition area in place of riprap.
- The existing conduit was extended 6 feet to facilitate the installation of a protective seepage filter around the conduit terminus.

**Lessons learned:**

Energy dissipator design capacity should consider both routine releases, as well as the maximum releases that may be required in the event of an emergency drawdown.

May not be practical or necessary to design the energy dissipator for the maximum outlet capacity.

**Reference:**

Bureau of Reclamation, *Criteria and Guidelines for Evacuating Storage Reservoirs and Sizing Low-Level Outlet Works*, ACER Technical Memorandum No. 3, 1990.

**Project:** Norman Dam

**Location:** Oklahoma

**Summary:** Slope slumping develops after unwatering of a stilling basin

Norman Dam is a zoned earthfill structure on the confluence of Little River and Hog Creek, located approximately 13 miles east of Norman, Oklahoma (figure A-59). The dam was constructed between 1962 and 1965. The reservoir impounded by the dam, Lake Thunderbird, has an active conservation capacity of 106,000 acre-feet at reservoir water surface elevation 1039.0 feet. Benefits provided by the reservoir include storage of water for municipal and industrial use, flood control, enhancement of fish and wildlife, and recreation.

The dam has a structural height of 144 feet, a crest length of 7,260 feet, crest elevation 1071.0 feet, and a crest width of 30 feet. The hydraulic height of the dam is 80.4 feet, measured between streambed elevation 969 feet at the dam axis and spillway crest elevation 1049.4 feet. The spillway is located approximately 2,920 feet from the left end of the dam.

The river outlet works is located approximately 730 feet to the right of the spillway, and consists of a trashracked intake structure that transitions to a 13-foot diameter upstream conduit, a gate chamber where the upstream conduit bifurcates and transitions to two metal-lined waterways (within each is installed a pair of 6.5- by



Figure A-59.—Aerial view of Norman Dam.



10-foot high pressure slide gates), a downstream conduit (the waterways transition and merge into a single conduit with a modified horseshoe cross section that is 15 feet 6 inches high and 17 feet wide), a downstream outlet portal at invert elevation of 991.96 feet, an open chute section, and a type II stilling basin (115.50 feet long and 40 feet wide). The discharge capacity of the river outlet works is 6,950 ft<sup>3</sup>/s at a reservoir water surface elevation of 1064.7 feet.

Norman Dam has been formally classified as a high hazard dam due to the potential inundation of downstream communities.

In 2006, to address O&M Recommendations, the stilling basin was required to be unwatered for removal of rocks and boulders and to document the condition of the concrete. The last underwater inspection of the stilling basin was in 2000.

In order to unwater the stilling basin, the contractor created a small earthen dike in the downstream river channel (figure A-60). A 6-inch diesel-driven pump was used to draw the water level down. Approximately 50 yd<sup>3</sup> of rocks and gravel ranging in size from a few inches to 30 inches in diameter were found in the stilling basin. The materials were located on the downstream two-thirds of the basin floor (figure A-61). The upper one-third of the basin floor was covered in 6 inches of fine sediment and organic materials. A crane was used to lower a front-end loader



Figure A-60.—The contractor created a small earthen dike in the downstream river channel to facilitate unwatering of the stilling basin.



Figure A-61.—Most of the rocks and gravel were located on the downstream two-thirds of the basin floor.

into the basin to load debris into a metal container for removal (figure A-62). The metal container was unloaded into a dump truck by the crane. The debris was moved to a location along the river channel approximately 500 feet downstream.

The basin floor was inspected for damage and joint offsets, but nothing of concern was found. The chute blocks and end sill dentates appeared to be in satisfactory condition. The underdrain outlets in the chute blocks also appeared to be functional, as clear water was observed exiting the drains.

Shortly after unwatering, an excavated slope in the surrounding basin area was observed to be experiencing cracking and developing a slump (figures A-63 and A-64). The crack revealed a displacement of about 2 inches in both the x and y directions. Seepage was also observed existing below the slump area below the normal water level. The likely cause of the slump was determined to be a result of water from the downstream river channel flowing back into the unwatered basin underneath the riprap and eroding material from the bank. This issue may have been eliminated if a better berm/cutoff had been constructed between the dewatered stilling basin and the river channel downstream. Remedial measures included increased monitoring, cutting the slope back to a 3:1, and backfilling any depressed areas (figures A-65 and A-66).

After the basin was refilled, the area was monitored for further settling since voids may have been created underneath the surface. A sinkhole, approximately 3 feet deep and 3 feet wide appeared on the surface of the bank above the water line indicating a void had indeed formed.





Figure A-62.—A crane was used to lower a front-end loader into the basin. The front-end loader was used to load debris into a metal container for removal.



Figure A-63.—Shortly after unwatering, an excavated slope downstream and to the right of the stilling basin was observed to be experiencing cracking and developing a slump. There are pink flags marking the edge of the slump area.





Figure A-64.—Cracking developing on slope near fence line.



Figure A-65.—Slump area after cutting back slope. Sod is being placed to prevent erosion.



**Figure A-66.**—After the basin was refilled, a sinkhole approximately 3 feet deep and 3 feet wide appeared on the surface of the bank above the water line.

### **Lessons learned:**

Surging velocities exist along the floor of the basin under certain release conditions. These flow conditions move riprap placed immediately downstream of the basin in an upstream direction. In addition, the flow conditions would prevent any rock thrown into the basin from being flushed out. Flow deflectors have been successfully installed at other dams to prevent upstream surging velocities. Another option is to avoid release rates which cause upstream surging velocities.

Placement of concrete over the downstream riprap to lock the rock in place was deemed to be not appropriate. The concrete could break loose over time as the riprap shifts and settles creating additional material which could be drawn upstream into the basin.

The drawdown rate at which the stilling basin is dewatered is crucial to ensure unbalanced water head pressures in the soils can be adequately relieved. Failure to do so could result in soil movement/sloughing or potential for piping initiation because of the increased hydrostatic head differential. Movement of material from the stilling basin underdrain system was seen while the basin was dewatered, but does not occur at normal water levels.

## Outlet Works Energy Dissipators

---

Periodic removal of rock from within the stilling basin may be more cost effective than concrete repairs.

The quantity and size of rock pulled into the stilling basin was so large in size that the rock itself seemed to provide protection from damage to the basin floor (i.e., the material did not move around once it entered the basin).

Dewatering procedures should include close monitoring of the surrounding area and slopes for instability and any unusual conditions.

### **Reference:**

Bureau of Reclamation, *Outlet Works Stilling Basin, Norman Dam, Norman Project, Oklahoma*, March 2006.



**Project:** Palisades Dam

**Location:** Idaho

**Summary:** Abrasion erosion damage to a stilling basin

Palisades Dam, built in the late 1950s is located on the main tributary of the Snake River in southeastern Idaho (figure A-67). The dam is a zoned embankment structure that impounds 1,200,000 acre-feet of water at the top of active conservation (elevation 5620 feet). The reservoir provides irrigation and hydroelectric power generation, flood control, and recreation. The dam has a crest length of 2,100 feet, a crest width of 40 feet, and a crest elevation of 5630 feet. A spillway containing a crest structure, two radial gates, a concrete lined tunnel and a discharge channel is located on the left abutment. The river outlet works, located at the left abutment, consists of a 20-foot diameter steel lined tunnel that branches into three pressure conduits, each of these conduits then bifurcates into two conduits, for a total of 6 terminal pressure conduits. Flows through the left and right pairs of terminal conduits are controlled by 7-foot 6-inch by 9-foot high pressure guard and regulating gates on each conduit. Flow through the middle pair of terminal conduits is controlled by a 96-inch diameter ring-follower guard gate and a 96-inch diameter hollow-jet regulating valve on each conduit. Flows from the high pressure regulating gates and hollow-jet valves are discharged into a 400-foot-long stilling basin. A 19-foot 8-inch by 28.03-foot fixed-wheel gate at the tunnel inlet provides the means to close the tunnel for dewatering and maintenance. The combined discharge



Figure A-67.—Aerial view of Palisades Dam.

## Outlet Works Energy Dissipators

---

capacity of the river outlet works gates and valves is approximately 33,000 ft<sup>3</sup>/s at reservoir water surface elevation 5620 feet. A power tunnel of similar features as the river outlet works is located 125 feet to the right of the river outlet works.

The river outlet works stilling basin is divided into 4 bays with 2 gates discharging into each bay. The bays are separated by large splitter walls with 2 rows of flow dissipators (dentates) in each bay. Repairs to the stilling basin have been ongoing since the late 1960s due to abrasion erosion and ball mill action from downstream rocks hydraulically pulled upstream into the stilling basin (figures A-68 through A-70). In the late 1980s, the project decided to develop a better concrete mix for the repairs. Several different methods and s were evaluated to find the best repair method. Since the stilling basin cannot be dewatered until October each year, repair conditions include snowstorms and temperatures ranging from sub-zero to the upper 20s. While the batches vary slightly from year to year the 7-day compressive strengths range from the mid 4,000s to the low 5,000s (lb/in<sup>2</sup>) and 28 day compressive strengths range from the mid 6,000s to the mid 7,000s (lb/in<sup>2</sup>). Table A-3 illustrates the developed mix design and table A-4 illustrates the properties of the fresh concrete. Due to the distance from town, it was decided to deliver dry batched concrete loads to the dam and add hot water to the batch at the dam.

Concrete surface preparation steps included perimeter saw cuts, sandblasting loose and damaged concrete from the repair surface and chipping around existing rebar to ensure good concrete to rebar bond. When completing slab repairs, chipping and removing ice just ahead of the concrete placement is common due to snow and



Figure A-68.—Damage to chute block. Note the exposed reinforcement.



Figure A-69.—Damage to splitter wall.



Figure A-70.—Damage to dentate sill.

freezing temperatures. Depending upon the placement, the concrete is pumped into the forms or slab (figures A-71 through A-73). New concrete was covered and heated until proper strength was achieved and forms could be removed, typically 2 to 3 days. The stilling basin was flooded immediately following form removal providing an excellent water cure. The outlet gates are not used in the winter due to ice formation, which allows the concrete to cure submerged until Spring.

## Outlet Works Energy Dissipators

---

Table A-3.—Developed mix design for repair of stilling basin

Mix design	Amount
Water-cement ratio	0.34
Type I/II low alkali cement	705 lb
Silica fume	72 lb
Water	262 lb
Course aggregate, ¾ in	1,974 lb
Fine aggregate—sand	1,071 lb
Air entraining admixture (AEA)	1 oz / cwt
Water reducing admixture	3 oz / cwt
High range water reducing admixture	10 oz / cwt
Fiber mesh	1.5 lb

oz/cwt = ounces per 100 lb cementitious / yd<sup>3</sup>

Table A-4.—Fresh concrete properties

Property value(s)	Units
Slump	5 to 8 inches
Air content	5 +/- 1.5 percent
Unit weight	151.3 lb / ft <sup>3</sup>





Figure A-71.—Concrete being pumped to forms for repairs to dentate sill.



Figure A-72.—Concrete being pumped for placement at floor.



Figure A-73.—Closer view of concrete being placed.

### Lessons learned:

The available time frame for making repairs often is during winter shutdown of the outlet works. This may require covering the concrete and as soon as the forms can be removed and the basin filled with water to prevent freezing of the concrete.

Concrete mix design may require changes based on conditions and newer materials.

Silica fume concrete is conventional Portland cement concrete containing admixtures of silica fume. Silica fume is a finely divided powder by-product resulting from the use of electric arc furnaces. When mixed with Portland cement concrete, silica fume acts as a “super pozzolan.” Concrete containing 5 to 15 percent silica fume by mass commonly can develop 10,000 to 15,000 lb/in<sup>2</sup> compressive strengths, reduced tendency to segregate, very low permeability, enhanced freeze-thaw properties and superior abrasion resistance.

### Reference:

Bureau of Reclamation, “Concrete Repairs at Palisades Dam,” *Concrete Corner*, March 2008.



**Project:** Palm Tree Creek Outlet

**Location:** Australia

**Summary:** Performance of high head vertical stilling well using a ported sleeve valve

The Palm Tree Creek Outlet is part of the outlet works at Teemburra Dam in North Queensland, Australia. The project was completed in 1996 and is owned and operated by SunWater, a Queensland Government owned corporation. Teemburra Dam is located about 30 miles inland from the coastal city of Mackay and supplies water for irrigation, industrial and urban uses. The reservoir capacity is approximately 121,000 acre-feet and is impounded by a 190-foot high concrete faced rockfill dam on Teemburra Creek and two saddle dams.

The Palm Tree Creek Outlet is located at the end of a 1 mile long pipeline downstream of the larger of the two saddle dams and is used to make releases to a stream in an adjacent valley. The pipeline ranges in diameter from 64 inches near the saddle dam to 48 inches over most of its remaining length. A short 36-inch diameter branch line directs water to the stilling well. The main 48-inch diameter pipeline is capped beyond the branch providing a future connection point for a small hydroelectric power station or a second outlet facility. A 36-inch diameter butterfly valve is provided as a guard valve immediately upstream of the ported sleeve valve. The Palm Tree Creek Outlet is designed to operate under 600 feet of head and to discharge up to 100 ft<sup>3</sup>/s.

The reason a vertical stilling well with ported sleeve valve was used was primarily to reduce noise impacts on nearby residences. The whole structure is below ground with only the concrete roof at the surface. Apart from reducing noise, having the structure below ground adds to the security of the site. The stilling well design is based on standard proportions provided in [Reclamation's \*Design of Small Canal Structures\* \(1978\)](#). The well is approximately 14 feet square and 26 feet deep below the control weir crest. Flow discharges from the well over the control weir into an 80-foot long, 48-inch diameter gravity main which delivers water to an open channel. In terms of energy dissipation and low noise emission, this arrangement performs exceptionally well.

Notwithstanding, problems have been experienced with unreliable operation of the original vertical ported sleeve valve installed in the outlet. The steel liner provided in the stilling well also initially suffered some local deformation between anchor points, particularly across the floor of the well no doubt associated with large pressure fluctuations formed by the high velocity jets issuing across the floor from the valve. The liner was regouted and has not suffered any further signs of distress to date.

## Outlet Works Energy Dissipators

---

The original sleeve valve installed in the outlet (figure A-74) incorporated four parallel sided ports. This valve remained in service for about 10 years, but presented a number of problems that made its operation unsatisfactory and discontinuous over that period. Initially problems were experienced in retaining the rubber sealing seat material in the area beneath each of the port. The valve also did not fully meet specified discharge when first commissioned. Subsequent works carried out by the valve supplier to increase its discharge capacity were accompanied by excessive vibration of the internal valve operating stem.

After numerous modifications carried out both under manufacturer's warranty and subsequently over the initial 10 years of operation SunWater decided to replace the valve with a V-ported sleeve valve of more durable design. The replacement works are not yet complete.

As an interim measure to maintain water supply the operating components of the original parallel ported valve were removed and replaced with a fixed cylindrical disperser section. This section comprises an array of small diameter round holes distributed over the surface area of the cylinder (pepper pot design). Under this configuration the outlet is run at fixed discharge by fully opening the guard valve. As the outlet is usually operated for several weeks at a time, this temporary arrangement has provided a satisfactory way of meeting water supply requirements while the replacement valve is procured. However, some damage to the guard valve seals is to be anticipated.



Figure A-74.—Stilling well at Palm Tree Creek Dam.

**Lessons learned:**

The vertical stilling well based on standard proportions provided in [Reclamation's \*Design of Small Canal Structures\* \(1978\)](#) performs extremely well in terms of energy dissipation and low noise levels under high head operation.

In high head vertical stilling well applications, consideration should be given to the use of a V-ported or possibly a pepper pot type sleeve valves with metal seals. If leakage is of concern then it can be controlled by closure of the guard valve under effectively no-flow conditions following closure of the regulating valve.

**References:**

SunWater Queensland, Australia.

Bureau of Reclamation, *Design of Small Canal Structures*, 1978.

**Project:** Pineview Dam

**Location:** Utah

**Summary:** Inline orifices in a steel bypass pipe

The Ogden River Project, in north-central Utah near Ogden and Brigham City, furnishes an irrigation supply to almost 25,000 acres of land lying between the Wasatch Mountains and the Great Salt Lake, and a supplemental municipal water supply for the city of Ogden. Project features include Pineview Dam and Reservoir, the reconstructed Ogden Canyon Conduit, the Ogden-Brigham Canal, the South Ogden Highline Canal, and the gravity-pressure distribution system constructed for the South Ogden Conservation District.

The Pineview Dam Hydroelectric Project was completed and began producing power June 1, 1991. The project was a joint venture between the Weber-Box Elder Conservation District and Bountiful City. The hydroelectric facility consists of one 2,500 hp horizontal Francis turbine with a 1,800 kW synchronous generator. Water is diverted from the 75-inch diameter Ogden Canyon Conduit through the facility and back into the conduit. The facility also has a river bypass where water can be diverted into the Ogden River. The operating flow range for the plant is between 120 and 300 ft<sup>3</sup>/s.

Water for project use is stored in Pineview Reservoir. Pineview Dam (figure A-75) is located at the eastern end of Ogden Canyon at the confluence of the north, south



Figure A-75.—Downstream face of Pineview Dam.

and center forks of the Ogden River. The dam is a zoned embankment containing 15,500 yd<sup>3</sup> of earth, rock and riprap materials. The crest of the dam is at elevation 4,908.0 feet, and is 30 feet wide and 600 feet in length. The dam is 137 feet in height and has a reservoir capacity of 110,150 acre-feet.

The hydro-electric plant withdraws water from the Pineview Reservoir near Ogden, Utah through two intakes located 80 feet under reservoir water surface. The intakes are 10 feet wide by 20 feet high and are equipped with 10-inch diameter openings in the trashrack. Two orifices exist with 41- and 40-inch diameter openings inside the 80-inch diameter steel pipe. The orifices in series are located in the bypass flow pipeline for emergencies or maintenance work on the turbines. The flow rate in the bypass is about 300 ft<sup>3</sup>/s with maximum velocities of about 50 ft/s.

**Lessons learned:**

The orifices are inspected annually and no operation and maintenance (O&M) issues with the orifices have been observed.

**Reference:**

Conversations with Dr. J.P. Tullis and Bonneville City Light and Power, 1999.

**Project:** Pomme de Terre Dam

**Location:** Missouri

**Summary:** Abrasion erosion in a stilling basin

The Pomme de Terre Dam is located on the Pomme de Terre River near Hermitage, Missouri. The dam was constructed in 1959, and diversion and storage began in July 1960 and October 1961, respectively. The dam is 7,230 feet long, 30 feet wide at the top, 950 feet wide at the base (maximum), and has a height of 155 feet (figure A-76).

The outlet works consists of an intake structure, a 14-foot diameter circular tunnel with two 6.5- by 14-foot hydraulic slide service gates, and a single 24-inch circular low flow gate, a reinforced concrete transition section, with a hydraulic jump stilling basin of natural rock. The outlet works stilling basin is 40 feet wide and 200 feet long (figure A-77). The basin floor and walls are natural rock. The basin has a three-step, 13-foot high end sill. The walls of the 90-foot transition section (figure A-78) are lined with 2-foot thick reinforced concrete anchored to the surrounding rock. The primary purpose of the transition slab, a 3-foot thick reinforced concrete slab anchored to the foundation rock, is to prevent undue erosion of the foundation and undercutting of the basin walls and the tunnel. Two concrete mixtures were used. The first layer, containing 3-inch maximum size aggregate and 376 lb/yd<sup>3</sup> of



Figure A-76.—Aerial view of Pomme de Terre Dam.



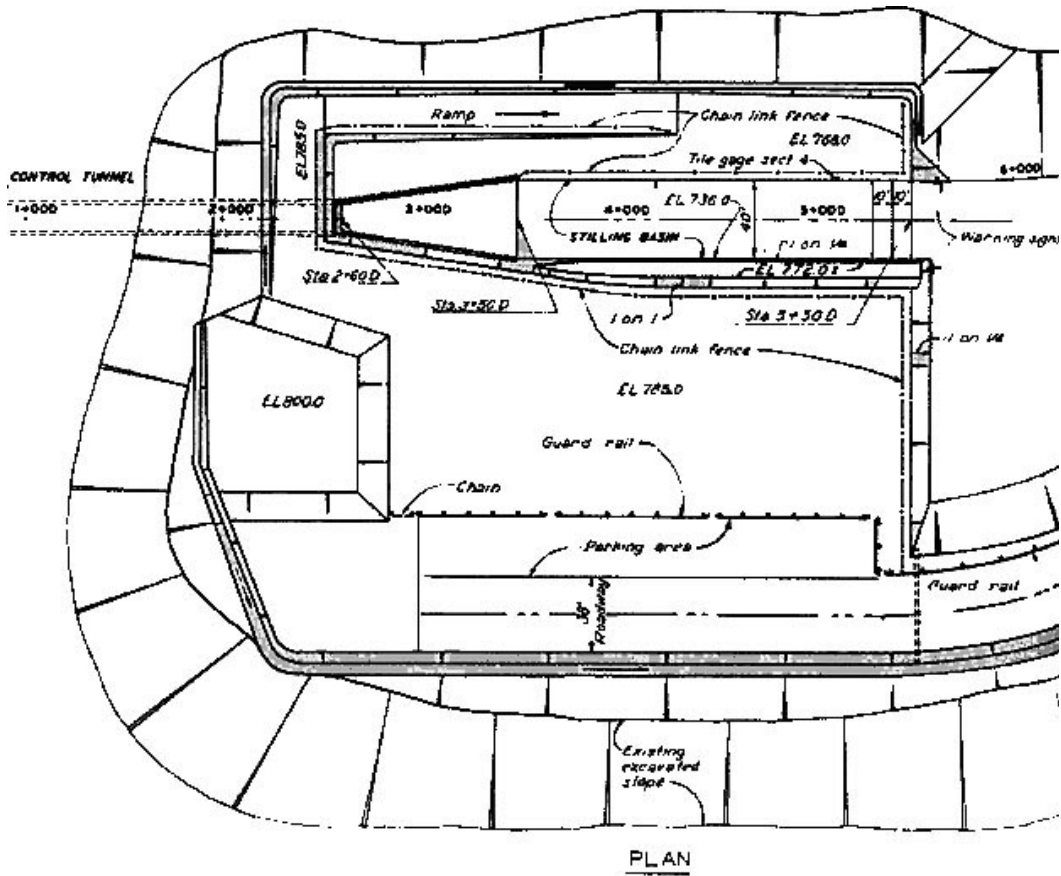

PLAN

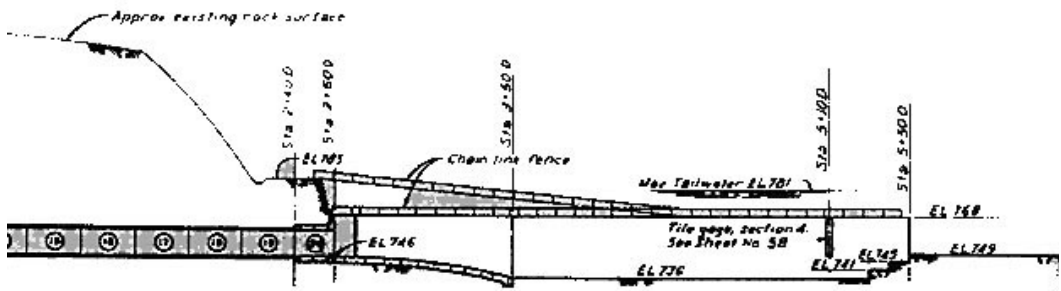

Figure A-77.—Plan and profile of the outlet works stilling basin.

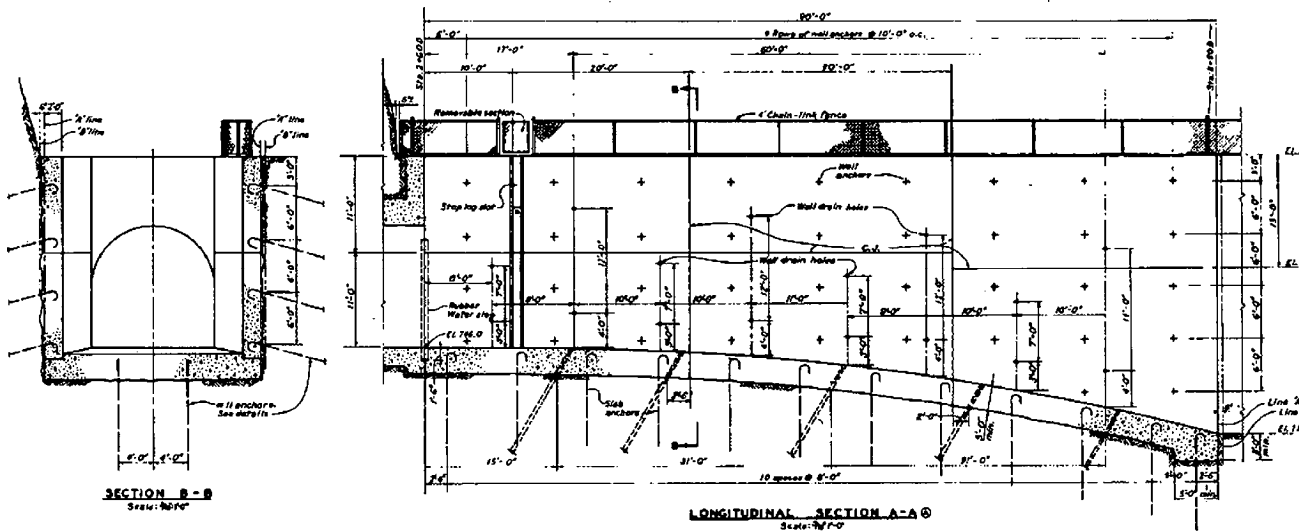

Figure A-78.—Transition section for the basin.

cement, was designed for 3,000 lb/in<sup>2</sup> compressive strength. The top layer (12-inch thickness) was proportioned with 0.46 water-cement for 4,000 lb/in<sup>2</sup>. Job mixture cylinder strengths ranged from 3,325 to 5,100 lb/in<sup>2</sup> with an average of 4,191 lb/in<sup>2</sup>. Air content and slump averaged 3.3 percent and 2½ inches, respectively. The design discharge velocity is 74.3 ft/s.

The initial unwatering of the basin occurred during the first periodic inspection in October 1965. Minor wear at the downstream end of the transition slab had exposed aggregate. Small, fist-size, well rounded rocks were found just downstream of the transition slab. The natural rock basin floor exhibited abrasion erosion of about 1.5 feet.

The basin was unwatered again in March 1971 as part of the second periodic inspection. The most significant abrasion erosion was on the right downstream end of the transition slab (figure A-79). The depth of abrasion erosion in this area was 4 to 12 inches. Some reinforcement was exposed and a few reinforcing bars had been removed by the abrasion erosion forces. However, since the slab was not contiguous with the walls and only protected the foundation rock, the eroded slab did not constitute an immediate threat to the integrity of the structure.

The third unwatering of the basin occurred during the third periodic inspection in October 1976. Additional abrasion erosion was observed on the transition slab. The major abrasion erosion was still on the right downstream portion of the transition slab; however, abrasion erosion on the left downstream portion of the transition slab had exposed anchors and a few more reinforcing bars.

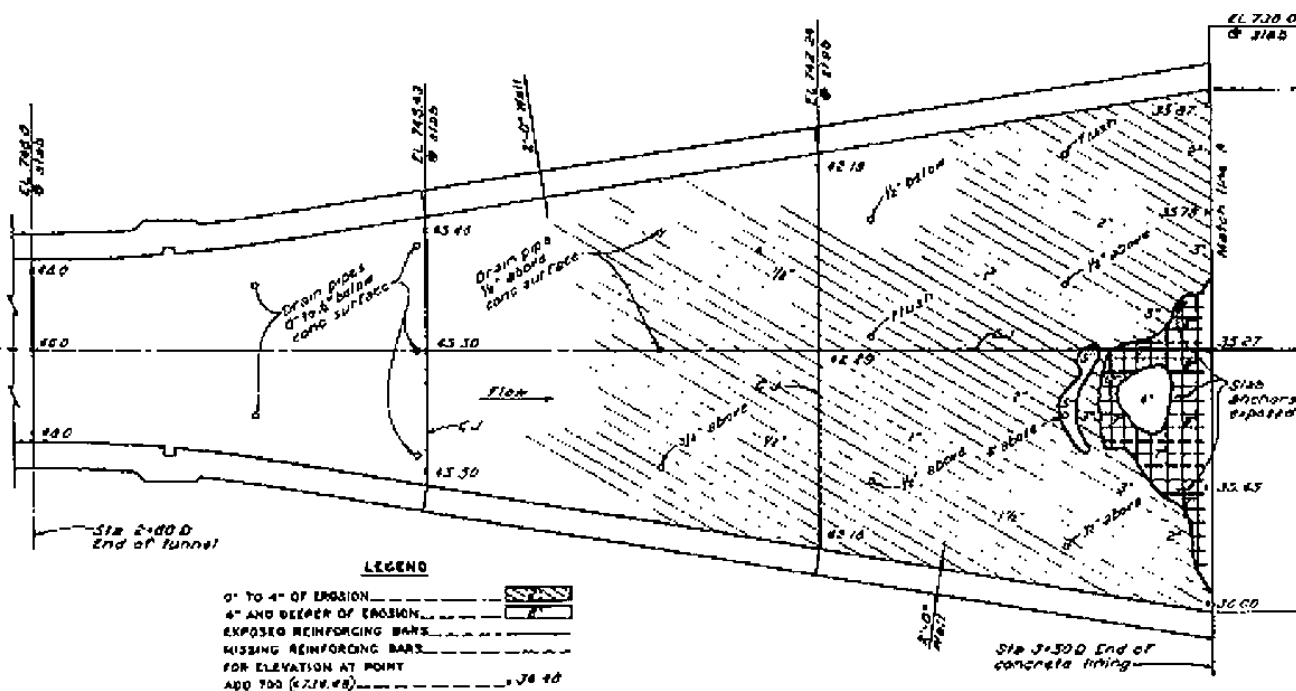

Figure A-79.—Abrasion erosion of in the transition section.

A temporary repair was made when the basin was unwatered for the 1976 inspection. Sandbags diverted gate leakage to the right edge of the transition slab. Seeping underdrains were plugged or the seepage was piped over the repair area. Concrete in the downstream 12 feet of the slab was removed in those areas where the depth of cover was less than 2 inches. The concrete was removed to a depth of 2 inches below the reinforcing steel. Reinforcing steel removed by the abrasion erosion forces was replaced. In areas where the concrete had not been removed by chipping, the surface was cleaned by sandblasting.

The repair concrete mixture was proportioned using materials similar to the original concrete for 5,000 lb/in<sup>2</sup> compressive strength as follows:

Material	Weight (lb)
Portland cement (type II)	680
Kansas River natural sand	1,240
Burlington limestone (No. 4 – 3/4-inch)	1,640
Water	279

Slump and air content of this mixture averaged 2½ inches and 4.4 percent, respectively. Compressive strengths at 28 days ranged from 4,560 to 5,640 lb/in<sup>2</sup> with an average of 5,085 lb/in<sup>2</sup>.

### Lessons learned:

The rate of abrasion erosion in the Pomme de Terre stilling basin is basically slow, and when good concrete strength is provided, the repair should provide good service. However, the repair does not reestablish the original slab conditions. The repaired clear cover over the reinforcing steel averaged about 3 inches, or one-half of the original cover. Minimum cover in the repair area was 2 inches. To provide a 6-inch cover would have required a much larger overlay and would probably require a change in the transition profile curve. The amount of work and effort to expand the repair is not directly related to the work required to make the temporary repair. An expanded repair would have required:

- Additional time, which includes time for design of the transition profile, anchors, and methods to handle drainage.
- Provisions to provide for minimum flow.
- Provisions for handling (during the extended time), the surface drainage into the basin, and any backwater that may flood the basin.
- Provisions to carry gate leakage over the repair area (the current repair diverted the gate leakage to a portion of slab that was not rerepaired).
- Provisions to insure the overlay does not fail in bond. With a larger area of overlay, the chances increase for a localized bond failure to progress and free a large segment of the overlay, which when it becomes unbonded may cause additional damage in the basin.

Future discharges and the amount of debris in the basin will likely be similar to past conditions. The strength of the concrete repair is probably as good as, and may be stronger than, the original concrete strength. The existing slab surface was prepared to provide an adequate bond between the existing concrete and the overlay.

### References:

U.S. Army Corps of Engineers, *Maintenance and Preservation of Concrete Structure*, TR C-78-4, April 1980.

**Project:** Pomona Dam

**Location:** Kansas

**Summary:** Abrasion erosion damage in a stilling basin

Pomona Dam is an earthen embankment located on the Hundred and Ten-Mile Creek near Vassar, Kansas. The dam is 7,750 feet long and has a height of 111 feet above the streambed (figure A-80).

Diversion flow began in July 1962 and reservoir storage began in October 1963. The reinforced concrete transition and stilling basin has a design discharge velocity of 57.8 ft/s. The hydraulic jump stilling basin is 35 feet wide and 80 feet long (figure A-81).

The basin is of U-wall design in which the basin walls are structurally continuous with the basin slab. Two staggered rows of baffles, 3 feet wide and 5 feet high are spaced on 7-foot centers. A two-step vertical face end sill is 4 feet high. Fill concrete was placed the width of the stilling basin for a distance of 20 feet downstream from the end sill. Concrete materials and mixture proportions were as shown in table A-5.



Figure A-80.—Aerial view of the downstream face of Pomona Dam.

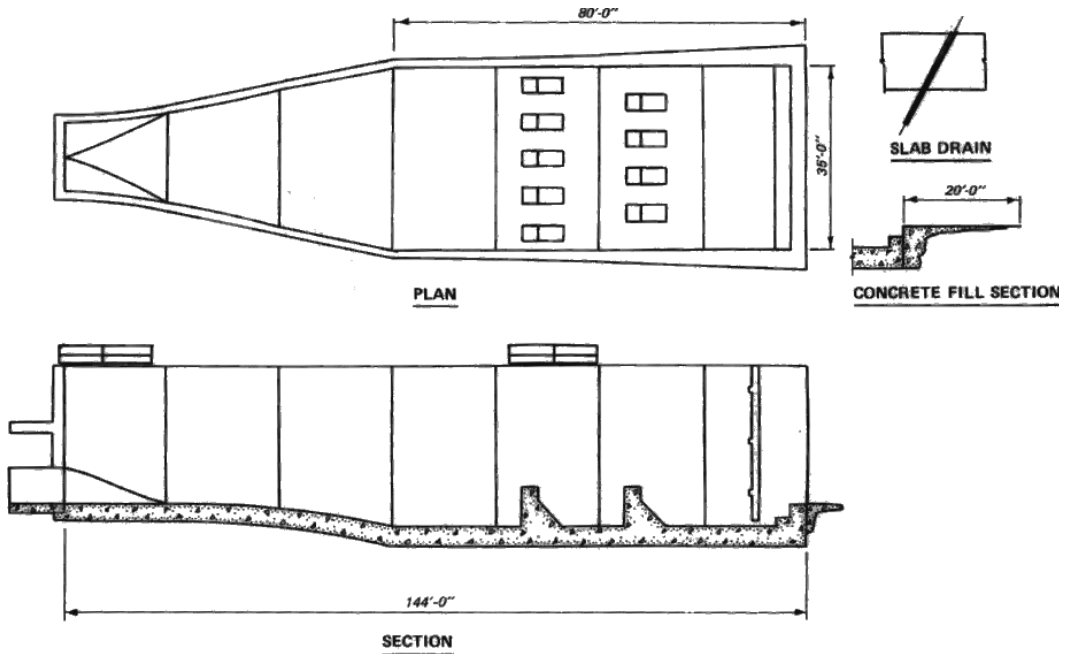

Figure A-81.—Stilling basin plan and section.

Table A-5.—Concrete materials and mixture proportions

Material	Weight, lb		
	2-C	2-E	2-F
Portland cement, type II	527	526	426
Kansas River natural sand	1,130	1,070	1,120
Stoner limestone, No. 4 to ¾ in	1,158	1,027	1,049
Stoner limestone, ¾ to 1½ in	1,024	1,132	1,016
Water	227	216	179

Average test results were as shown in table A-6.

Table A-6.—Average test results

Test	2-C	2-E	2-F
Slump, in	1.5	1.5	1.25
Air content, %	4.0	4.9	4.6
28-day compressive strength, lb/in <sup>2</sup>	5,638	5,625	5,023



The initial unwatering of the basin was made in February 1968 as part of first periodic inspection (figure A-82). Abrasion erosion caused by the movement of rocks and other debris in the flow had occurred at the downstream end of the transition slab and on the upstream one third of the basin slab. Reinforcing steel was exposed in the upstream left third of the basin and just upstream of the baffles. A supplemental inspection of the stilling basin was made in October 1970. The inspection revealed significant additional abrasion erosion of the concrete and extensive reinforcing steel exposure. The major damage was attributed to the flow conditions caused by relatively low discharges, since approximately 97 percent of the releases have been 500 ft<sup>3</sup>/s or less.

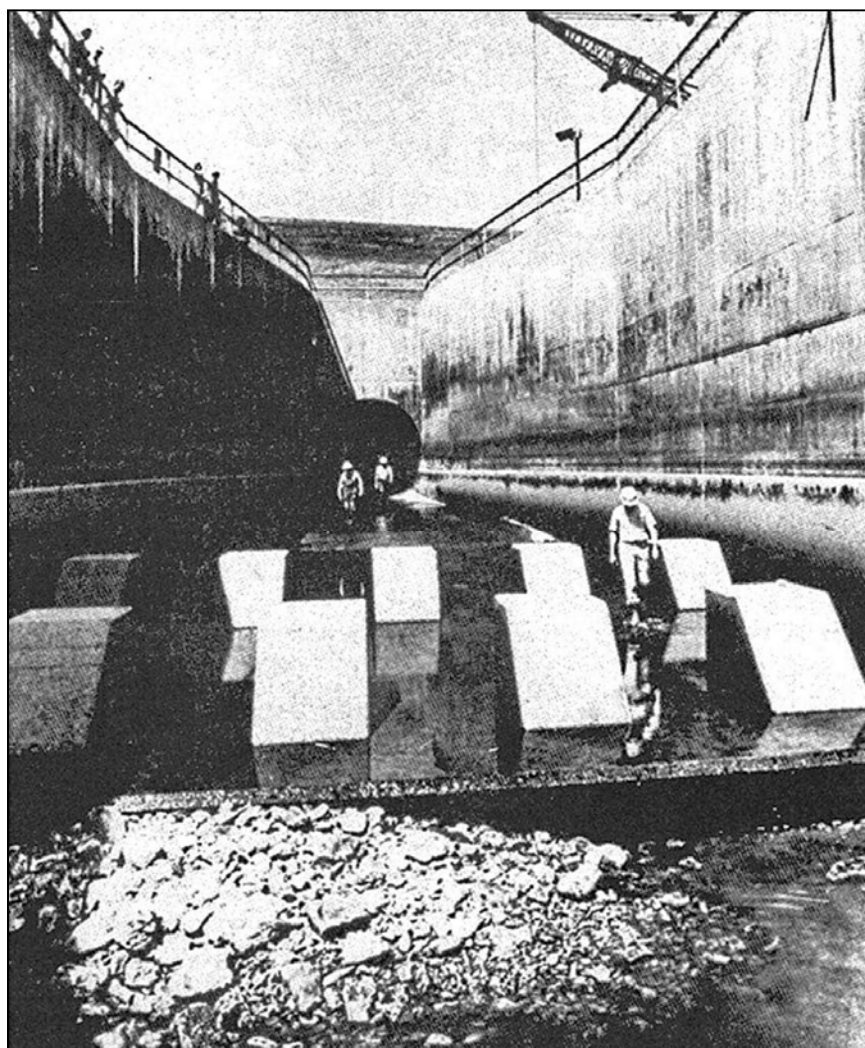
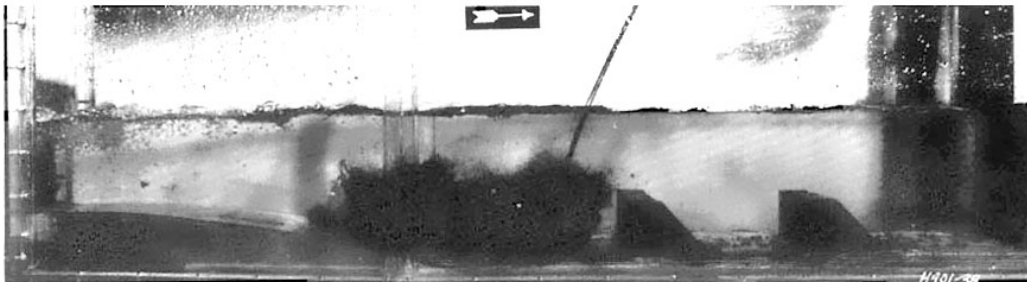

Figure A-82.—Unwatered stilling basin.

## Outlet Works Energy Dissipators

---

Model tests of the existing stilling basin (Oswalt, 1971) verified that severe separation of flow from one sidewall and eddy action, strong enough to circulate stone in the model, within the basin occurred for low and intermediate discharges and tailwaters common to the site. Figures A-83a and A-83b show subsurface upstream flow in the right side of the basin for discharge rates of 500 and 1,000 ft<sup>3</sup>/s. Abrasion erosion damage was observed in the prototype stilling basin was a result of the eddy action, and debris and rock were always found when the basin was unwatered. Although it is possible that some of the visiting public might have thrown rock into the basin, the model indicated that with a flow of about 4,200 ft<sup>3</sup>/s, the eddy within the basin was sufficiently large and strong to generate considerable reverse flow from the exit channel into and along one side of the basin. Return flow could transport riprap from the exit channel into the basin, particularly with the stepped, vertical end sill originally provided.



*Tailwater El. 930.0*

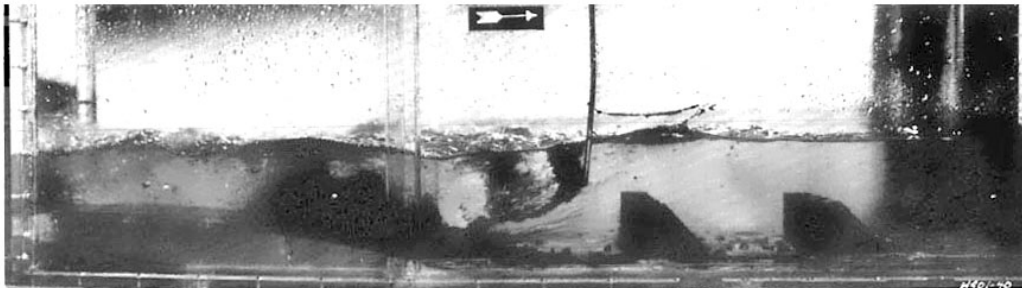

*Tailwater El. 927.0*

Figure A-83a.—Stilling basin flow conditions at pool elevation 974 feet and discharge 500 ft<sup>3</sup>/s.

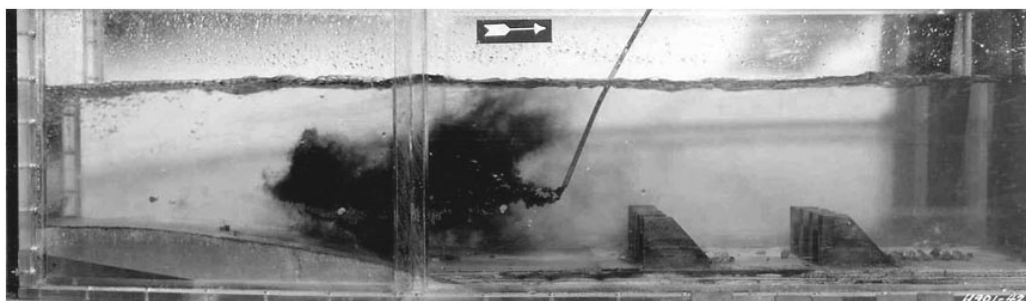

*Tailwater El. 933.0 feet*

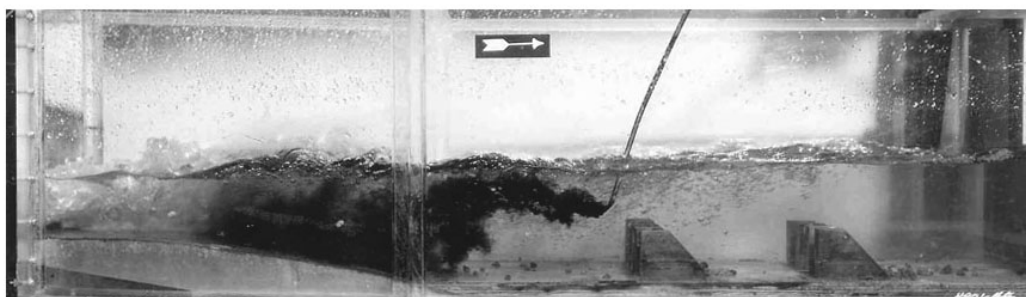

*Tailwater El. 928.5 feet*

Figure A-83b.—Stilling basin flow conditions at pool elevation 974 feet and discharge 1,000 ft<sup>3</sup>/s.

**Lessons learned:**

Abrasion erosion damage can occur for flows much less than the design maximum when a reverse eddy pulls downstream material into the basin.

**References:**

Oswalt, N.R., *Pomona Dam Outlet Stilling Basin Modifications*, Memorandum Report, U.S. Army Engineer Waterways Experiment Station, Vicksburg, Mississippi, 1971.

U.S. Army Corps of Engineers, *Maintenance and Preservation of Concrete Structure*, TR C-78-4, April 1980.

**Project:** Seven Oaks Dam

**Location:** California

**Summary:** Design of a plunge basin

Seven Oaks Dam is located on the Santa Ana River, 4 miles northeast of Redlands, California. The dam, completed in 1999, is a 600-foot high earth-rockfill embankment and provides flood control. Figure A-84 shows a downstream view of the completed dam.

The regulating outlet works passes through the left abutment (looking downstream). The outlet provides for controlled releases of water from the reservoir and comprises an intake structure, upstream tunnel, gate chamber, a downstream tunnel, an exit channel, and plunge basin as shown in [figure A-85](#).

The outlet works was designed to pass up to 7,000 ft<sup>3</sup>/s. The intake can accommodate sediment deposits up to 165 feet high. A small pool is maintained during 8 to 9 months of the year to encourage the deposition of sediment. During the remainder of the year the reservoir is dry.



Figure A-84.—Seven Oaks Dam.

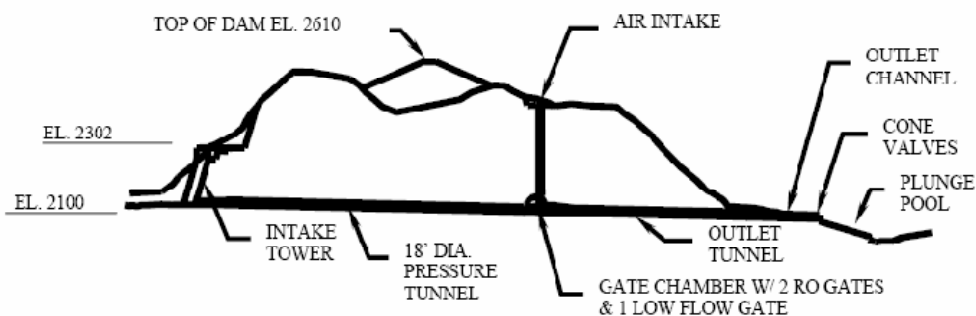

Figure A-85.—Profile of outlet works.

The intake structure is a 200-foot high inclined structure, anchored against the excavated rock slope. The intake structure incorporates a 36-foot diameter wet well and a multilevel withdrawal system. A pressure tunnel connects the intake structure to the exit channel and plunge basin. A gate chamber is located approximately 1,000 feet downstream from the intake structure. A 36-inch diameter minimum discharge line was placed beneath the tunnel floor to release flows less than 90 ft<sup>3</sup>/s.

An 18-foot diameter pressurized reinforced concrete tunnel connects the intake structure to a reinforced concrete gate chamber that contains two service gates (hydraulic slide type), two emergency gates, a low flow gate, and an emergency low flow gate. The service and emergency gates are 5 feet wide by 8.5 feet high and the low flow gates are 2 feet wide by 3.5 feet high.

The downstream tunnel is approximately 600 feet long and is an 18-foot-wide by 18.5-foot-high horseshoe shaped tunnel, except for the transition at the gate chamber. The exit channel at the downstream end of the tunnel is 280 feet long and is 18 feet wide by 14 feet high. The plunge basin serves as an energy dissipator for the outlet-flows not going through the cone valves.

The original concept for the energy dissipator was a preexcavated plunge basin. The depth was based on the Veronese equation:

$$D = 1.32H^{0.225}q^{0.54} \quad \text{eq. 11}$$

where,

$D$  = ultimate scour depth below tailwater (ft)

$H$  = elevation difference between reservoir and tailwater (ft)

$q$  = unit discharge (ft<sup>3</sup>/s/ft per foot width)

Physical model studies by Cooper (1992) with a movable bed showed that the Veronese equation predicted the observed depth very closely. However, the lateral

## Outlet Works Energy Dissipators

extent of the plunge basin was so great that it would eliminate the only access road to the outlet works. Therefore, a solution had to be found to reduce the depth of the basin. The depths obtained using the Veronese equation is for a relatively compact jet entering the basin. Consideration was given to spreading the energy over a larger impingement area, so the energy per unit surface area would be less and hence the erosion depth would be less. This line of reasoning led to the development of deflectors on the end of the rectangular chute. These deflectors spread the jet both laterally and longitudinally.

The final design consists of deflectors on the end of the chute, a paved region downstream of the end of the chute to prevent undercutting when passing low flows, and riprap on the banks to reduce erosion from recirculating flows in the basin as shown in figures A-86, A-87, and A-88. The beneficial effects of the deflectors are shown in figure A-89.

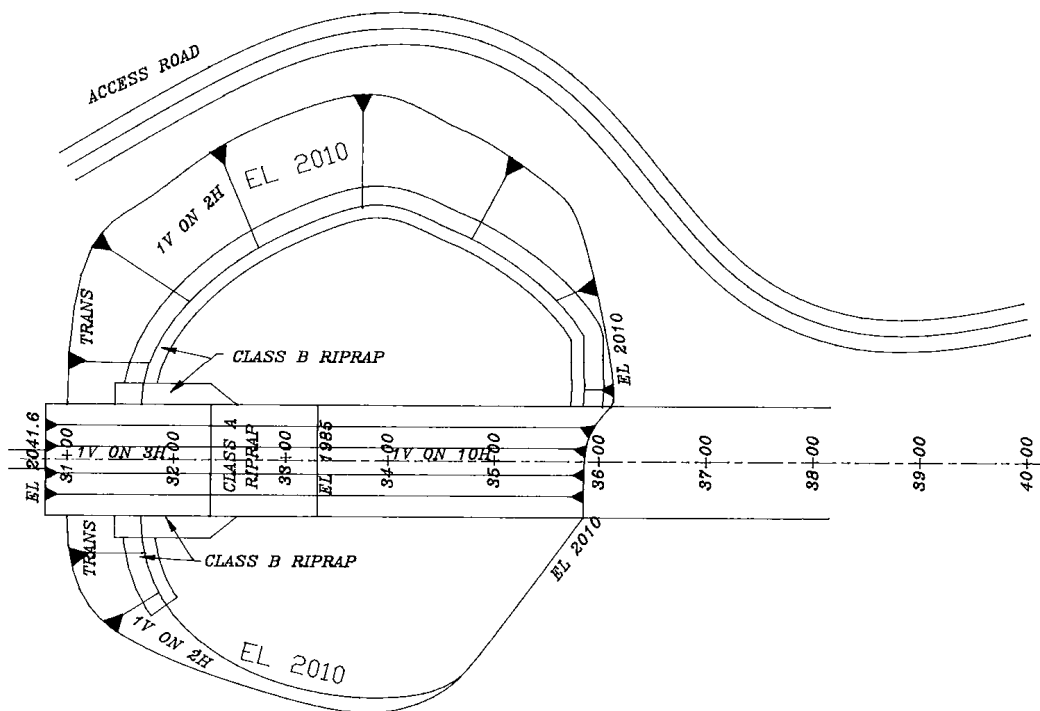

Figure A-86.—Plunge basin.



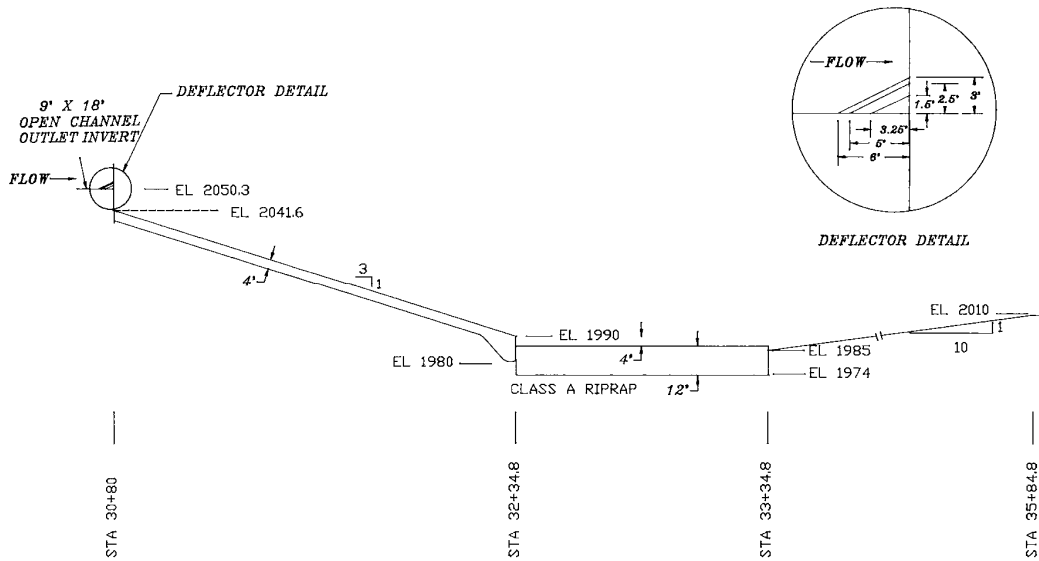

Figure A-87.—Profile of the plunge basin.

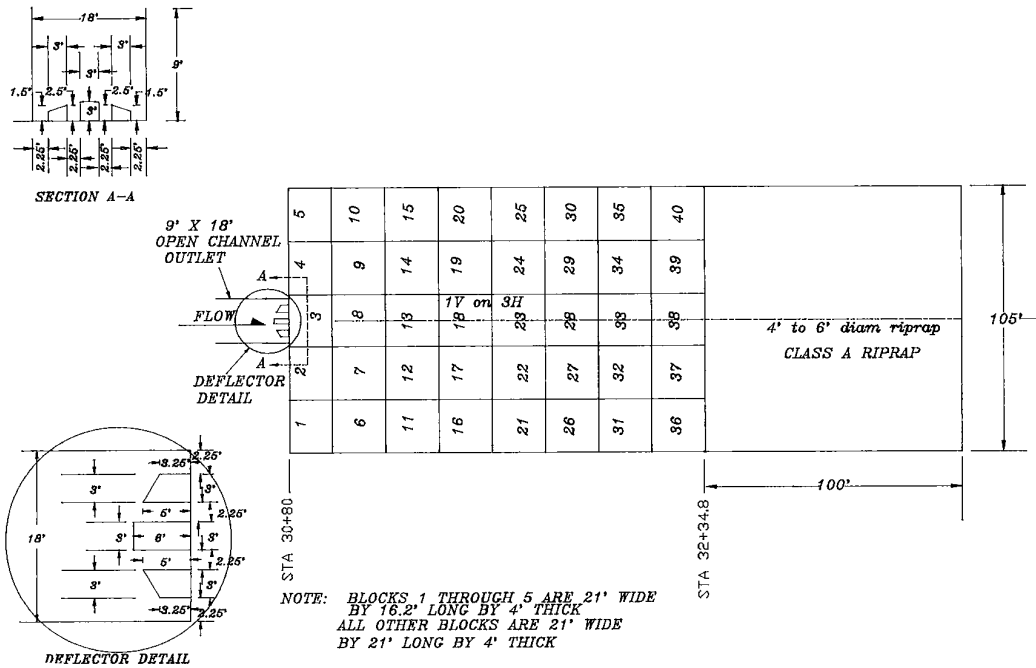

Figure A-88.—Plunge basin apron and deflector details.



Figure A-89.—Plunge basin in operation at Seven Oaks Dam.

Unrelated to the plunge basin design, during the testing of the outlet works gates, the invert liner to the downstream tunnel failed. A heavy load of gravel, cobbles, and boulders was transported through the tunnel. This severely eroded the tunnel invert, even though it was constructed with high strength silica fume concrete. The plunge basin apron just downstream of the tunnel outlet was also severely damaged (Burgi, et. al., 2006).

### Lessons learned:

Deflectors on the end of the rectangular chute will spread the jet both laterally and longitudinally. The deflector reduced the depth of the preexcavated plunge pool. A slab downstream of the deflectors was necessary to prevent erosion at low flow.

### References:

Cooper, Debra, *Outlet Works for Seven Oaks Dam, Santa Ana River, San Bernardino County, California, Hydraulic Model Investigation*, U.S. Army Engineer Waterways Experiment Station, Vicksburg, Mississippi, 1992.

Burgi, P.H., D.P. Cosakos, H.T. Falvey, M.J. Sawka, S.J. Schlenker, and T.N. Waller, *Investigation and Repair of the Outlet Works Tunnel Slab Damage—Seven Oaks Dam, Ana River, California*, IAHR Symposium on Hydraulic Structures, Ciudad Guayana, Venezuela, October 2006.

**Project:** Seven Oaks Dam

**Location:** California

**Summary:** Inline orifices

The minimum discharge line in the Seven Oaks Dam outlet works (built 1999) consists of a 36-inch diameter steel conduit through the dam. During the nonflood season, flow is bypassed around a plunge pool (to preserve water) through an extension that releases to the natural channel. With design head of 300 feet, a maximum discharge of 100 ft<sup>3</sup>/s is passively controlled by a combination of conduit friction and a series of five sharp-crested orifices with  $D_o/D$  diameter ratios of 0.62 to 0.77 within a 36-inch outside diameter conduit section at the downstream end (see figure A-90). The transition from pressurized conduit to open channel is accomplished with an impact type energy dissipator (Reclamation, 1963). At design head (300 feet) and discharge rate (100 ft<sup>3</sup>/s), the series of orifices was designed to operate such that the maximum cavitation intensity should not exceed a level midway between critical and incipient damage cavitation levels based on the methodology by Tullis (1989) outlined in chapter 8 of this manual.

A design drawing of an orifice assembly and housing structure is shown in figure A-91. Photos of the impact type energy dissipator are shown in figures A-92 and A-93.

In 2005, the orifice system was operated about 80 to 100 feet above the design head without problems during prototype outlet works testing and for 2 months thereafter in an emergency operation. Prototype pressure data was collected upstream and downstream of each orifice during an approximate discharge rate of 120 ft<sup>3</sup>/s with maximum orifice velocity of 69 ft/s. While cavitation noise was detectable at most orifices, the wall pressure data at the vena contracta locations were only slightly subatmospheric and well above vapor pressure, thereby allowing the cavitation to occur harmlessly within the interior of the expansion zones.

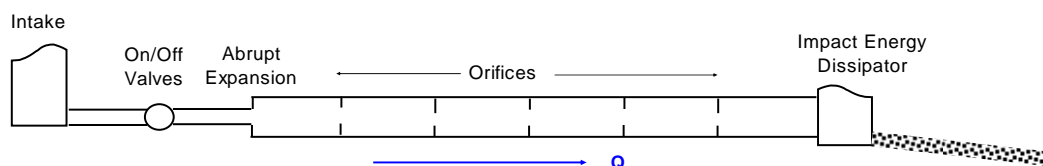

Figure A-90.—Schematic for Seven Oaks Dam minimum discharge line extension.

Figure A-91.—Seven Oaks Dam minimum discharge line orifice design drawing.

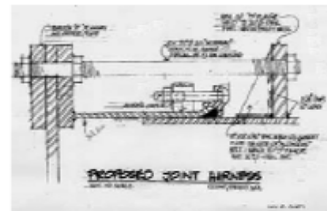
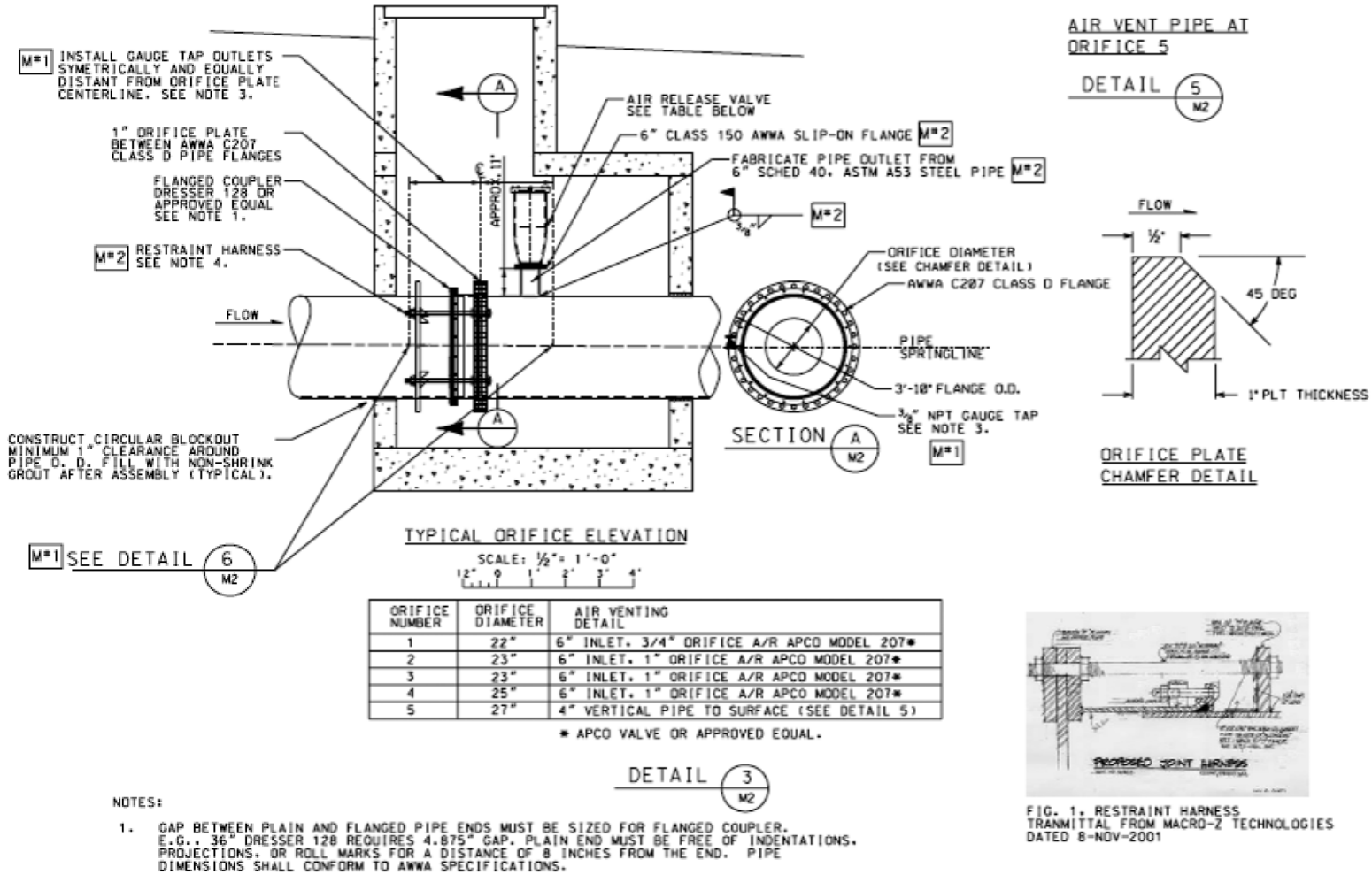

FIG. 1. RESTRAINT HARNESS TRANSMITTAL FROM MACRO-Z TECHNOLOGIES DATED 8-NOV-2001



Figure A-92.—Downstream end with impact type energy dissipator (dry).



Figure A-93.—Same energy dissipator with flow (120 ft<sup>3</sup>/s).

Average prototype wall pressure data from Seven Oaks is shown in [figure A-94](#) for 2.5 feet upstream and 1.5 feet downstream of each orifice. Time series data for both upstream and a downstream tap is shown in [figure A-95](#) for one of the more active orifices, where significant cavitation noise was observed and the vena contracta velocity was about 62 ft/s. The maximum resolution of the data acquisition system



# Outlet Works Energy Dissipators

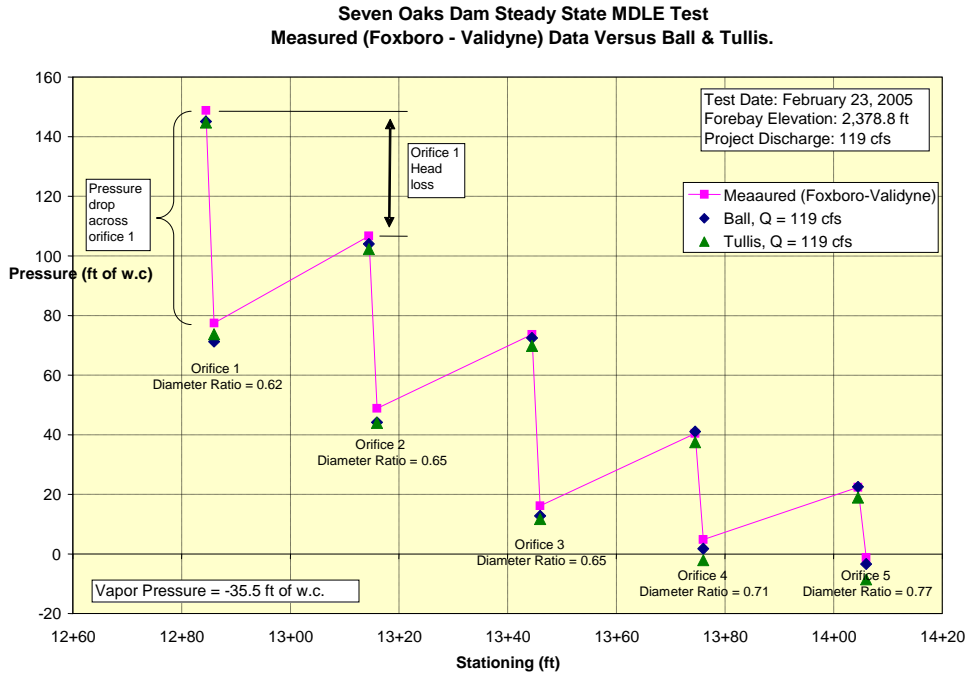

Figure A-94.—Comparative pressure gradeline data from measurements versus calculations based on coefficients from Ball and Simmons (1963) and Tullis (1989).

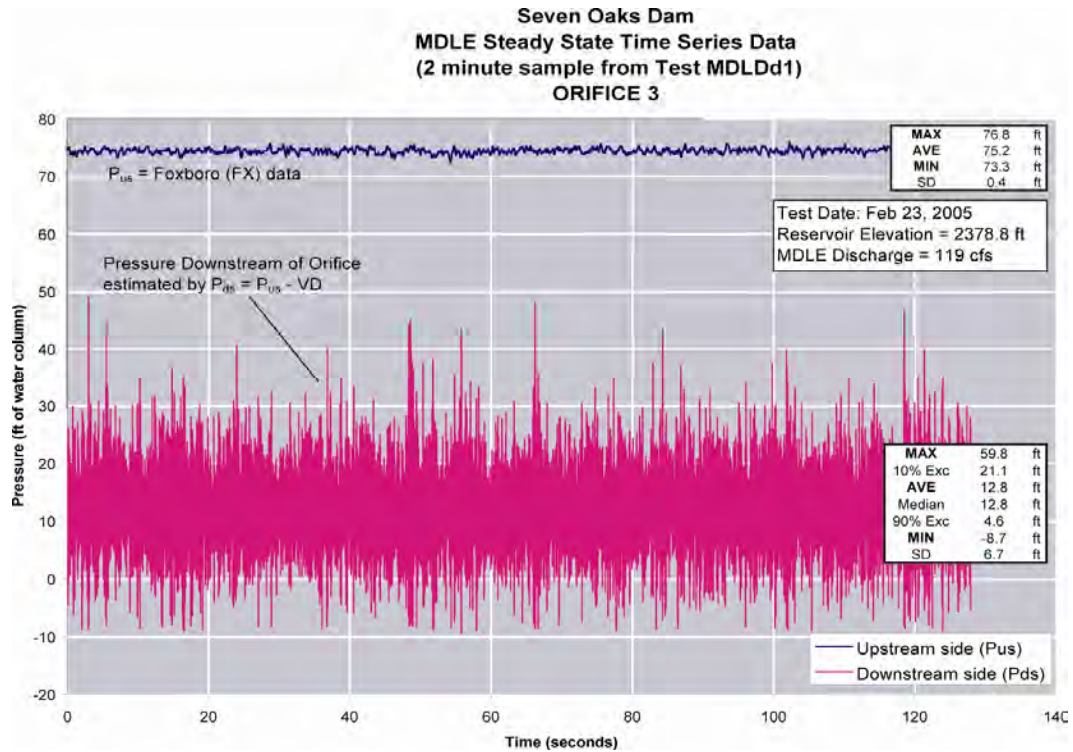

Figure A-95.—Time series data sample from steady state test.



was 250 Hz. Anti-aliasing filters were not used. A frequency analysis of the data is shown in [figure A-96](#).

During the February 23, 2005 flow tests at Seven Oaks Dam (at an estimated 119- to 121-ft<sup>3</sup>/s discharge rate), cavitation noise observations were made. The noise was recorded by decibel meter positioned at the base of the stem for the air valve downstream of each orifice. The field observations regarding cavitation noise and air releases from the air valves along with the sound measurements (starting from upstream end) are shown in table A-7. Orifice 5 was the noisiest in terms of decibels due to the air suction noise. Orifice 3 was the noisiest in terms of cavitation type popping sounds and orifice 4 was next. The others had considerably less cavitation noise.

**Table A-7.**—Field observations during 2005 flow tests at Seven Oaks Minimum Discharge Line

Seven Oaks Dam minimum discharge line extension field observations	Incipient cavitation?	Critical cavitation?	Incipient damage?
Orifice 1: Light popping activity, frequency about 3 per second (60 decibels (DB) average); No air releases.	Yes	No	No
Orifice 2: Moderate popping noise, more frequent popping sounds merged into a conglomerate of noise (65 DB average); No air releases.	Yes	probably	unknown
Orifice 3: Heavy continuous noise (75 DB average); No air releases.	Yes	probably	unknown
Orifice 4: Moderate/heavy continuous noise (71 DB average); Air usually exiting 1" air valve, occasional back suction.	Yes	probably	unknown
Orifice 5: No cavitation noise, very loud suction noise (83 DB Average). Air is pulled into 4-inch air vent; difficulty opening hatch cover.	NA	NA	No

### Comparison of Tullis cavitation methods with prototype data

Prototype pressure data was collected in February 2005 at the Seven Oak Dam Minimum Discharge Line Extension (MDLE) consisting of five inline orifices within a 35.25-inch inside diameter pipeline. This represents the largest known scale in the United States where prototype pressure data and cavitation (audible) observations

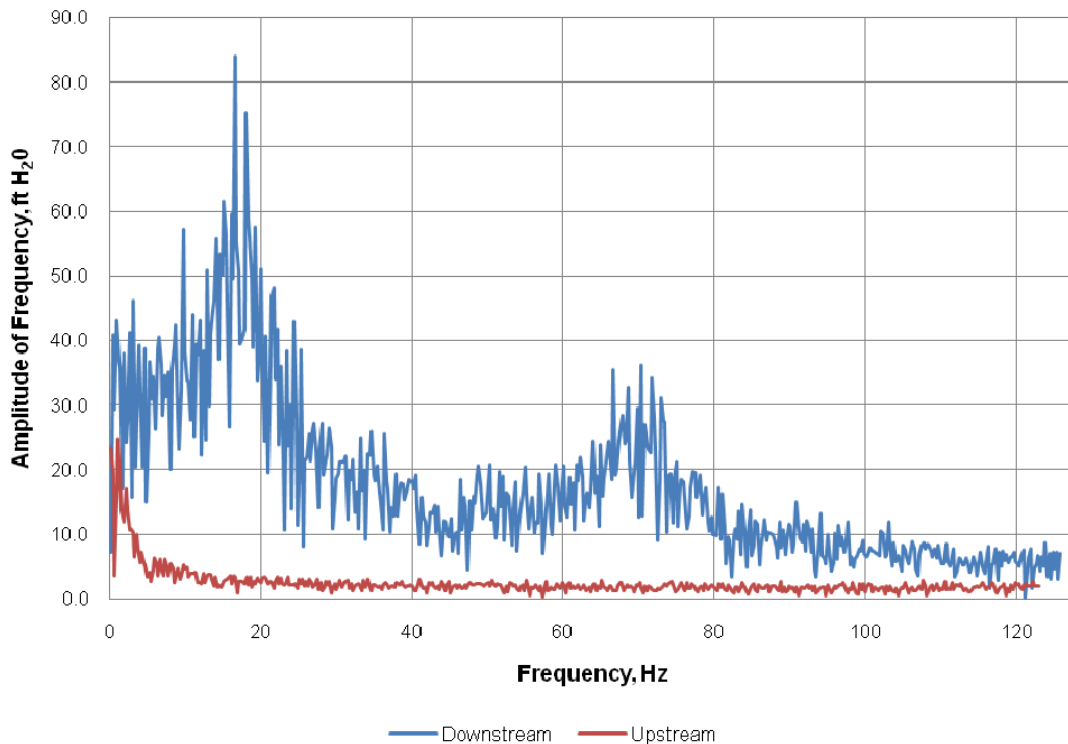

Figure A-96.—Orifice 3 frequency analysis.

were simultaneously collected. A summary of the upstream four orifices<sup>6</sup> geometry and average pressure head data is shown in [table A-8](#). The average orifice velocity as a function of estimated discharge rate is also provided on the right side.

### Estimation of discharge rates

The estimated discharge rate during the flow test was 119 ft<sup>3</sup>/s based the recorded reservoir head, pressures taken at intermediate locations upstream of the MDLE system and the design MDLE loss coefficients. A summation of the total head loss across the first four orifices shows the field data and computed equivalent head loss per Tullis at 119.4 ft<sup>3</sup>/s matches within 0.1 feet. Applying other head loss coefficients, the sum of the computed losses will match the sum of the field head losses with [Ball & Simmons \(1963\)](#) (interpolated coefficients) at a flow rate of 121 ft<sup>3</sup>/s and with Eq. 23 from [Rahmeyer \(1988\)](#) at 121.8 ft<sup>3</sup>/s, respectively (see [table A-9](#)).

<sup>6</sup> The pipe section immediately downstream of orifice 5 (most downstream) is vented to the atmosphere so pressure differential or head loss measurements were not available at orifice 5.

Table A-8.—Seven Oaks MDLE inline orifice dimensions, average pressure heads with respect to pipe springline (gauge) ( $H_v = -31.3$  ft), and average orifice velocities depending on range of estimated discharge rates.

Orifice	$Q \downarrow$ Orifice dia. ( $D_o$ ) (in)	$\beta$ $D_o/D$	Average pressure head above pipe CL		$HL^3$ orifice head loss* (ft)	$DH^4$ orifice head drop (ft)	Assumed discharge	
			$H_u^1$ US tap (ft)	$H_{vc}^2$ DS tap (ft)			119.3 ft <sup>3</sup> /s	121.8 ft <sup>3</sup> /s
							$V_o^5$ orifice velocity (ft/s)	$V_o^5$ orifice velocity (ft/s)
1	22.0	0.62	148.8	77.5	41.6	71.3	45.2	46.1
2	23.0	0.65	106.7	48.8	32.6	57.9	41.3	42.2
3	23.0	0.65	73.7	16.2	32.7	57.5	41.3	42.2
4	25.0	0.71	40.5	4.8	17.6	35.6	35.0	35.7
5	27.0	0.77	22.4	-1.2	10.2	23.6	30.0	30.6

<sup>1</sup>  $H_u$  measured 2.5 ft upstream of orifice (US tap)  $H_v$  = vapor head  
<sup>2</sup>  $H_{vc}$  measured 1.5 ft downstream of orifice (DS tap)  
<sup>3</sup> Head difference between upstream taps—0.5 feet friction loss  
<sup>4</sup> Head difference between upstream and downstream taps at each orifice  
<sup>5</sup>  $V_o = \text{assumed } Q / (0.25 * \pi * D_o^2)$

Table A-9.—Estimated range of probable discharge rates based on matching sums of computed head losses from different references with sums of prototype orifice head losses.

Orifice	$Q \downarrow$ Orifice	$\beta$ $D_o/D$	Field	Tullis (1989)		Ball et al. (1963)		Raymeyer (1988)	
			Measured head loss $HL$ (ft)*	Assumed discharge (ft <sup>3</sup> /s)					
				$K_o$	$HL$ (ft)	$K_o$	$HL$ (ft)	$K_o$	$HL$ (ft)*
1	0.62	41.6	8.77	42.3	8.49	42.0	8.51	42.7	
2	0.65	32.7	6.64	32.0	6.45	31.9	6.38	32.0	
3	0.65	32.7	6.64	32.0	6.45	31.9	6.38	32.0	
4	0.71	17.6	3.78	18.2	3.76	18.6	3.58	18.0	
Total head losses (ft)			124.5	124.5	124.5	124.5	124.6	124.6	

\* Estimated pipe friction loss of 0.5 feet was deducted from pressure differences measured between upstream taps of adjacent orifices to estimate field orifice head losses.

### Determination of field coefficients and cavitation indices using Tullis method

The field cavitation coefficients from Seven Oaks data under the Tullis method (chapter 8) is obtained directly from the pressure data:

$$\sigma_{\text{field}_i} = \frac{H_{d_i} - H_{vg}}{H_{L_i}} = \frac{H_{u_{i+1}} + H_f - H_{vg}}{H_{u_i} - (H_{u_{i+1}} - H_f)}$$

In which,

$H_{d_i}$  = Pressure head about 10 diameters downstream of orifice i

$$H_{d_i} = H_{u_{i+1}} + H_f$$

$H_{u_{i+1}}$  = Pressure head upstream of orifice i+1, d/s of orifice i

$H_f$  = friction loss between orifices (30 feet apart)

$$H_f = \frac{f \cdot L}{D} \cdot \left( \frac{Q^2}{0.25 \cdot \pi \cdot D^2} \right) = \frac{0.010 \cdot 30 \text{ ft}}{2.94 \text{ ft}} \cdot \left( \frac{(119 \text{ ft}^3/\text{s})^2}{0.25 \cdot \pi \cdot (2.94 \text{ ft})^2} \right) \approx 0.5 \text{ feet}$$

$H_{vg}$  = Vapor pressure head  $\approx -31.3$  ft

$$H_{vg} = \left\{ P_{vga} - \left( 14.7 \text{ psia} - 0.005 \left( \frac{\text{psia}}{\text{ft}} \right) \times \text{Elevation} \right) \right\} \cdot 144 \left( \frac{\text{in}^2}{\text{ft}^2} \right) / \gamma$$

Elevation  $\approx 2,000$  feet

$P_{vga} = 0.12$  psia at water temperature 40 °F

$H_{L_i}$  = Head loss created by orifice i

$$H_{L_i} = H_{u_i} - H_{u_{i+1}} - H_f$$

For example, at orifice 1, the downstream pressure head  $H_d$  for orifice 1 ( $H_{d_1}$ ) is obtained from  $H_u$  from the next orifice ( $H_{u_2}$ ) + friction loss ( $H_f$ ).<sup>7</sup>

$$H_{d_1} = H_{u_2} + H_f = 106.7 + 0.5 = 107.2 \text{ feet.}$$

$$H_{d_1} - H_{vg} = 107.2 - (-31.3) = 138.5 \text{ feet}$$

$$H_{L_1} = H_{u_1} - (H_{u_2} + H_f) = 148.8 - (106.7 + 0.5) = 41.6 \text{ feet}$$

$$\sigma_{\text{field}_1} = 138.5 / 41.6 = 3.3$$

Values of  $\sigma_{\text{field}}$  are similarly computed for orifices 2 through 4 and are shown in table A-10.

---

<sup>7</sup> The magnitude of the downstream head term  $H_d$  for a given orifice is largely determined by  $H_u$  at the next downstream orifice. The taps for  $H_u$  are located  $0.85 D$  upstream of the downstream orifice and would be subject to some small influence of conversion from velocity head to pressure head. Evaluating data from the Seven Oaks Low Flow Gate tests (where there are multiple taps in line upstream of the gate); the estimated influence at  $0.5 D$  is less than 40% of total conduit velocity head (5 feet) in the main pipeline. Thus, the effect caused by the proximity of the taps to the orifices would be such that the actual values of  $H_d$  could be lower than the values computed in this section by a maximum of 2 feet. A deduction of 2 feet from  $H_d$  has a minimal effect (-0.1) on the magnitude of the field cavitation indices and causes no change in the positions of field coefficients with respect to the reference indices (incipient, critical and incipient damage).

Table A-10.—Comparison of Tullis indices with respect to Seven Oaks Dam data

Orifice	$\beta$ $d_o/D$	Tullis (1989) methodology applying scale factors					Field cavitation level
		$\sigma_{syst}^*$	$\sigma_{field}^*$	$\sigma_i$	$\sigma_{cr}$	$\sigma_{id}$	
1	0.62	3.2	3.2	4.2	2.8	1.4	$\sigma_{cr} < \sigma_{field} < \sigma_{cr}$
2	0.65	3.3	3.1	5.0	3.2	1.5	$\sigma_{field} = \sigma_{cr}$
3	0.65	2.3	2.1	5.0	3.2	1.4	$\sigma_{cr} < \sigma_{field} < \sigma_{id}$
4	0.71	2.9	2.8	7.0	4.4	1.6	$\sigma_{cr} < \sigma_{field} < \sigma_{id}$
5	0.77	4.3		10.2	6.2	2.0	Vented

\* Tullis system and field cavitation coefficient computed using Tullis (1989) methodology

The next step is to determine the Tullis cavitation reference indices (chapter 8) and apply the prototype and pressure scale factors to compare the predictions from the Tullis method with observed prototype cavitation levels (i.e., field audible observations).

An example to determine the incipient cavitation index ( $\sigma_{inc}$ ) for orifice 1 scaled up to Seven Oaks scale under the Tullis method:

Equation 27 (from chapter 8)

$$CD_1 = 0.019 + 0.083 \cdot \left(\frac{22}{35.25}\right) - 0.203 \cdot \left(\frac{22}{35.25}\right)^2 + 1.35 \cdot \left(\frac{22}{35.25}\right)^3 = 0.32$$

Incipient cavitation index at model scale ( $D = 3$  inches) for orifice 1 parameters ( $D_o/D, CD$ ):

$$\sigma_{im} 1 = 0.62 + 4.4 \cdot (0.32) + 6.6 \cdot (0.32)^2 + 1.3 \cdot (0.32)^3 = 2.75$$

$$K_{o_1} = \left( \frac{1}{(0.32)^2} - 1 \right) = 8.77 \quad \text{Orifice 1 head loss coefficient (eq. 24)}$$

$$Y = 0.3 \cdot (8.77)^{-0.25} = 0.174$$

$$SSE_1 = \left( \frac{35.25}{3} \right)^{0.174} = 1.54 \quad \text{Size scale effect for } D = 35.25 \text{ inches at orifice 1, equation 31}$$

Incipient cavitation index for orifice 1 at prototype scale per Tullis Method:

$$\sigma_{inc} 1 = \sigma_{im} 1 \cdot SSE_1 = 2.75 \cdot 1.54 = 4.2$$

The computed field coefficients (s-field) are provided in table A-10 for comparison to the Tullis (1989) cavitation indicator levels (incipient  $\sigma_i$ , critical  $\sigma_{cr}$  and incipient damage  $\sigma_{id}$ ). Note that the field coefficients ( $\sigma_{field}$ ) are all lower than incipient

cavitation coefficients ( $\sigma$ ) and thus (correctly) predict cavitation at all orifices (except orifice 5 which is vented). Also, note that the field coefficients are  $\leq$  critical cavitation levels ( $\sigma_{cr}$ ) at orifices 2 through 4, which predict notable (but nondamaging) cavitation levels that generally agree with field observations. The project staff have not closely inspected the orifices or internal pipeline to verify whether or not any incipient damage has occurred in the system; however the system was run at high head for about 2 months without any apparent ill effects.

The system cavitation coefficients ( $\sigma_{sys}$ , left column) were computed from (chapter 8) in the design simulation spreadsheet of the 2005 test flow condition using design parameters (assumed roughness dimensions, pipe friction factors, and minor loss coefficients for bends, sudden expansions, open Ball valves, etc.). The field and system cavitation coefficients largely match.

### Lessons learned:

The system was designed using the Tullis (1989) method so that the cavitation indices ( $\sigma_{sys} = \sigma_{field}$ ) would be at or above the midway point between critical and incipient damage levels at design head and discharge (i.e., the cavitation intensity would be greater than midway between critical and incipient damage). With the system being tested at head about 30 percent higher than design head, the system and field indices were nudged nearer to the incipient damage level at orifices 3 and 4, as expected. Orifice number 5 might have operated in the damage zone without the admission of air through the air vent downstream of the orifice (calculations indicate otherwise, but it would have been close to damaging levels). The decision to use the air vent at orifice 5 provided assurance against the possibility of damage in the downstream orifice where backpressures ( $H_d$ ) are lowest. An additional benefit of the air vent was that it also created a higher rate of volumetric flow or air bulking in the pipeline downstream of orifice 5, thereby raising backpressures in the upstream pipeline and orifices by an estimated 0.5 to 1.0 lb/in<sup>2</sup>. In general, with the lower backpressures, the system or cavitation indices will be lower and higher levels of cavitation become more likely without reducing the incremental head losses (i.e., degrees of constriction) of the orifices. The tendency for orifices to operate with increasing degrees of cavitation in the downstream direction was also noted in the laboratory tests by Zhang and Chai (2001). Their design applied equal head drops per orifice. Without a significant backpressure provided by the tailwater, the energy in an in-line orifice system must be more gradually dissipated in lower increments of head loss approaching the downstream end. Aeration of the flow may not be possible with other multiple orifice configurations, such as tunnel spillways. Other options and possible limitations with the downstream section of orifice systems are noted in chapter 8. The use of physical model studies should be considered to verify computational predictions.

The energy dissipation system using a series of inline orifices was designed to operate between critical and damaging cavitation and it was run for about 2 months at about



20 percent higher heads without any apparent damage. The sound levels at some orifices were as high as 83 dB. However, this level is not high enough to require ear protection for exposures of 8 hours per day according to Reclamation's *Construction Standards*.

The data acquisition system was not capable of detecting the threshold of incipient cavitation since the highest frequency of resolution was only 250 Hz. Acoustic emission transducers of hydrophones with a frequency response of around 250 kHz should have been used to detect cavitation, which is in the range of 50 Hz.

The flow from the impact energy dissipator was very rough for a discharge of about 20 percent greater than the design discharge, but the rock riprap was large enough to prevent erosion.

**References:**

Ball, J.W. and W.P. Simmons, *Progress Report on Hydraulic Characteristics of Pipelines and Sudden Enlargements Used for Energy Dissipation*, Hydraulics Branch Report No. Hyd-519, Bureau of Reclamation, December 1963.

Bureau of Reclamation, *Hydraulic Design of Stilling Basins and Energy Dissipators*, A.J. Peterka, Engineering Monograph No. 25, 1984.

Rahmeyer, W., "Energy Dissipation and Limiting Flow through Orifices," *ASCE Journal of Transportation Engineering*, Vol. 114, No. 2, March 1988.

Tullis, J. Paul, *Hydraulics of Pipelines, Pumps, Valves, Cavitation, Transients*, 1989

Zhang, Q.Y. and B.Q. Chai, "Hydraulic Characteristics of Multistage Orifice Tunnels," *ASCE Journal of Hydraulic Engineering*, Vol. 127, No. 8, August 2001, pp. 663–668.

**Project:** Standley Lake Dam

**Location:** Colorado

**Summary:** Design and construction of a lined plunge basin

Standley Lake Dam is situated on Big Dry Creek a tributary to the South Platte River in northeastern Colorado and in the City of Westminster. The dam is a rolled earthfill embankment with a height of 113 feet and a crest length of 5,900 feet and crest elevation of 5515 feet. The dam was originally constructed in 1913 and the reservoir was enlarged several times since the original construction. The reservoir has a surface area of 1,222 acres and storage capacity of 43,344 acre-feet. The purpose of the dam and reservoir is to provide a water supply for the Cities of Westminster, Thornton and Northglenn, recreation, and irrigation for the Farmers Reservoir and Irrigation Company.

Standley Lake Dam was required to be rehabilitated and stabilized to meet current state-of-the-practice for embankment dam design and construction. As part of this rehabilitation project, a downstream stability berm was required to be placed along the downstream toe of the existing embankment. This required the existing downstream energy dissipator structure for the outlet works to be moved downstream and the outlet works conduits to also be extended downstream. Due to ongoing problems and safety concerns with the existing outlet works, the dam owner decided to abandon the existing outlet works in place and construct a new outlet works at the left abutment of the dam. The major problem with this concept was that the reservoir could not be drained for an extended period of time to construct the new outlet works. Therefore, the construction of the new outlet works was required to be performed with a full reservoir.

The design replaces the old, deteriorating outlet works with a safe, reliable, long lasting outlet capable of delivering the design flows for irrigation, senior water rights, municipal supply, and environmental requirements. The new outlet works conformed to the Colorado State Engineer's Office (SEO) requirements for pressurized outlet works and emergency water release. In order to conform to SEO requirements, the new outlet works was sized to remove the top 5 feet of water in the reservoir in five days, which is equivalent to discharging an emergency flow of 600 ft<sup>3</sup>/s. Additional benefits include the ability to withdraw water from the reservoir at two separate reservoir elevations for water quality purposes. [Figure A-97](#) shows the completed stilling basin for the new outlet works.

The new outlet works consists of two outlet conduits (each fitted with an intake structure), a 35-foot diameter 100-foot-deep valve shaft, a steel lined 1,000-foot-long tunnel from the shaft to the downstream portal at the toe of the dam, a new valve house and stream release structure, and interconnecting piping and appurtenances.



Figure A-97.—View of completed stilling basin for the new outlet works at the stream release facility at Standley Lake Dam.

The two new 72-inch internal diameter outlet conduits were installed from the valve shaft through the soft sedimentary rock formations (claystone and sandstone) of the left abutment and exiting into a small excavations in the reservoir bottom. These conduits were placed by utilizing microtunnelling technology with wet recovery of the tunneling machine, while the reservoir full. The lower, 1,250-foot-long conduit was installed to withdraw water from elevation 5440 feet and the upper conduit (650 feet long) will withdraw water from 5470 feet. These conduits will deliver water to the valve shaft located on the left abutment.

Microtunnelling with wet recovery is a fairly new construction method. Projects involving larger diameter conduits, longer lengths with the tunneling machine recovered in greater depths of water have been successfully completed, however this combination of length, diameter and recovery depth has limited precedent. As with any underground work, unexpected conditions frequently occur and should be expected.

The tunnels were bored from the 100-foot deep (35 feet internal diameter) shaft located north of the existing spillway about 70 feet from the edge of the reservoir. After completion of these two conduits and the downstream tunnel, the shaft was converted into a permanent valve shaft with a small operations building at ground level matching the crest of the dam (elevation 5516.5 feet). Each intake conduit was provided with a 72-inch diameter butterfly valve with associated small diameter valves and piping for flooding and draining the conduits. The 72-inch diameter valves are used to select the level from which water is withdrawn. These valves have some ability to withdraw water from each level simultaneously for providing a blend

of water from the two levels. Vents provide air and vacuum control. Provisions for obtaining water quality samples and determining the pressure in the inlet conduits are provided in the valve shaft.

The first 1,000 feet of 102-inch diameter welded steel pipe downstream of the valve shaft was installed using conventional tunneling techniques. The remainder of conveyance piping downstream of this tunnel portal utilized conventional trench and backfill construction methods. The 102-inch diameter welded steel pipe continues parallel to the toe of the dam from the portal down to Big Dry Creek, where two 60-inch internal diameter steel pipes connect to the fixed-cone valves in the stream release structure. Downstream of this connection, the 102-inch diameter conduit is reduced to an 84-inch internal diameter welded steel pipe for conveying water to the valve house. At this location it splits into three 48-inch internal diameter welded steel pipes for connection into the existing raw water supply lines to the water treatment plants.

Water removed from the reservoir during an emergency release event is discharged to Big Dry Creek through the new stream release facility. The function of this facility is to remove the energy from the reservoir water so it can be safely discharged to Big Dry Creek for irrigation, environmental flow and emergency release. The energy is dissipated and discharge controlled by passing the water through fixed-cone valves installed in the facility. Each valve can pass a flow ranging from 2 to 300 ft<sup>3</sup>/s. Water from the fixed-cone valves discharges into a shallow concrete stilling basin, and flows through a short grouted riprap lined channel to Big Dry Creek. The stream release facility is a small reinforced concrete structure to house and protect the butterfly valves, fixed-cone valves, valve actuators and flow meters.

The two 60-inch diameter pipes discharge into a concrete structure where a 60-inch diameter butterfly valve is provided. A 60- by 36-inch reducer connects the valve to a magnetic flowmeter and a 36-inch fixed-cone valve (also called a Howell-Bunger valve). These energy-reducing control valves will release flows to Big Dry Creek for irrigation, environmental, and emergency purposes. The two 36-inch diameter valves will provide for an entire range of releases from 2 to 600 ft<sup>3</sup>/s. Hoods are provided with each fixed-cone valve to contain the water spray exiting from the fixed-cone valves.

The instrumentation in the stream release facility includes the flow measurement, which can be read locally and is transmitted to the valve house. The fixed-cone valve can be operated either from the stream release facility or from the valve house. The butterfly guard gates (which are normally in the full open position and rarely operated) can only be operated locally at the stream release facility.

Fixed-cone valves generally do not require stilling basins and design guidelines are not available. However at this site, the alluvial soils and soft claystone/sandstone rock do not resist erosion, so protection from erosion is required. The fixed-cone

valve also is required to have a hood over the discharge jet to confine the jet and limit the width of spray plume. The soils and weak rock are easily eroded. Therefore, a reinforced concrete stilling basin was provided to reduce the velocity in the flow and protect the downstream channel. The reinforced concrete apron is designed for 600 ft<sup>3</sup>/s. The apron slab slopes down from the end of the valve on a 3 horizontal to 1 vertical slope. The slab is 12 feet below the centerline of the valve. The apron is 30 feet wide with 7-foot high vertical side walls and divider wall. The valves are mounted in a horizontal position and the theoretical length of the jet will be about 30 to 40 feet after dropping 10 feet. A 3-foot high weir is placed near the end of the basin to form a shallow pool. A 9-foot high concrete baffle wall is located approximately 50 feet from the valve. This baffle wall will break up the jet-flow, spread the water across the basin, and cause a hydraulic jump. The wall will force the water to flow down under the wall through the backwater formed by the weir wall. The sloping sides of the channel downstream of the basin are armored with grouted riprap. A short divider wall was provided in the center of the basin to separate the flows when both valves are discharging. [Figure A-98](#) shows the plan and profile of the stilling basin.

Operational tests were conducted to verify performance of the fixed-cone valves. [Figures A-99](#) through [A-102](#) show the testing of the outlet works and stilling basin.

# Outlet Works Energy Dissipators

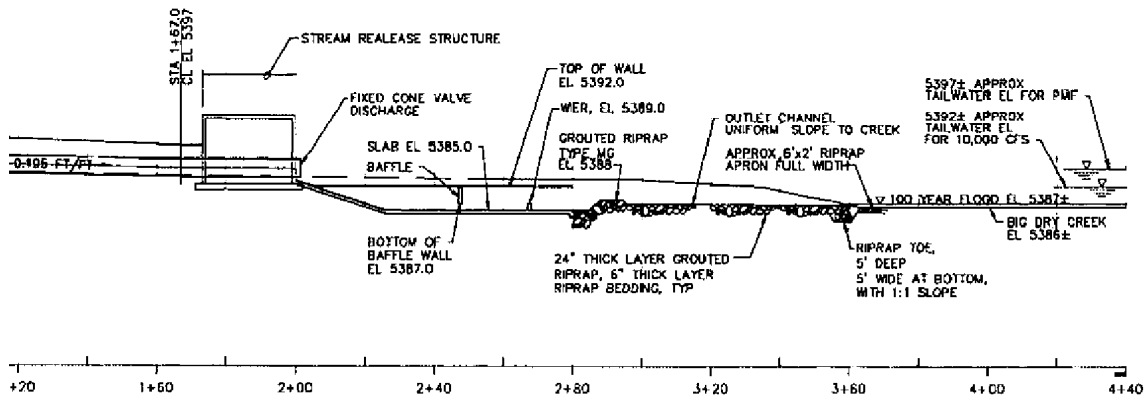
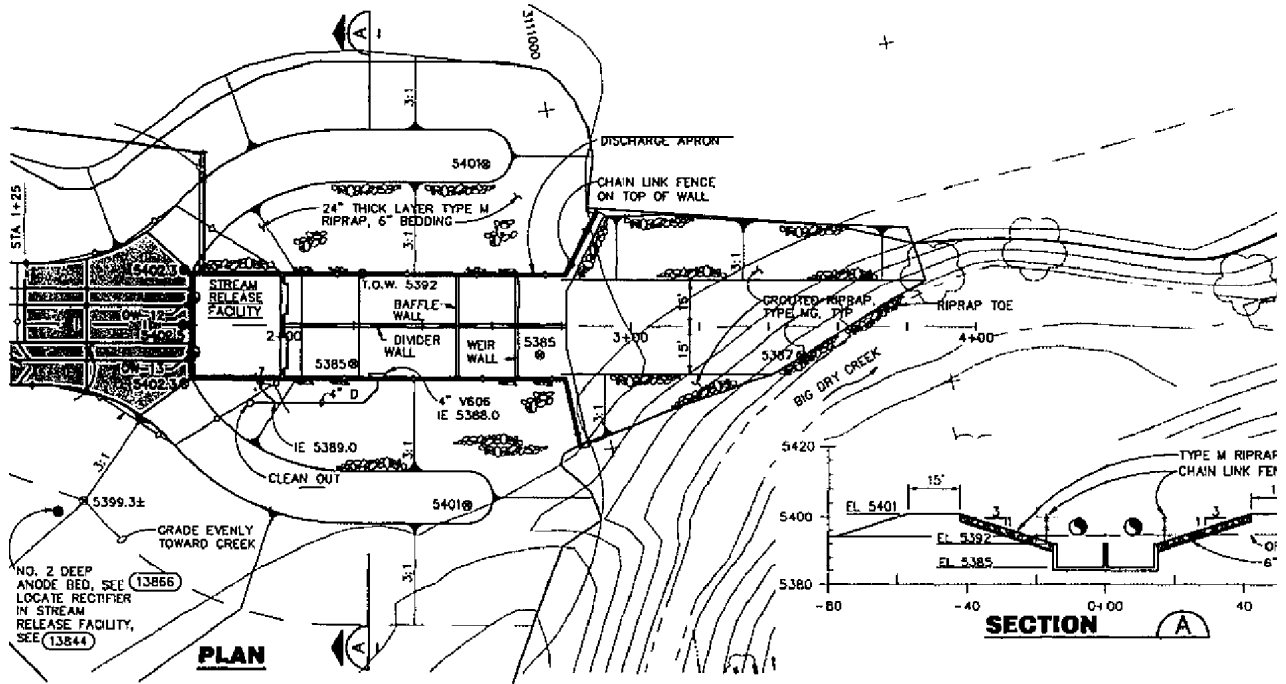

Figure A-98.—Plan and profile of the stilling basin.





Figure A-99.—View looking downstream at the outfall channel during testing of one of the fixed-cone valves at 35 percent opening ( $147 \text{ ft}^3/\text{s}$ ).



Figure A-100.—View looking downstream shown the right fixed-cone valve discharging at 35 percent opening ( $150 \text{ ft}^3/\text{s}$ ).

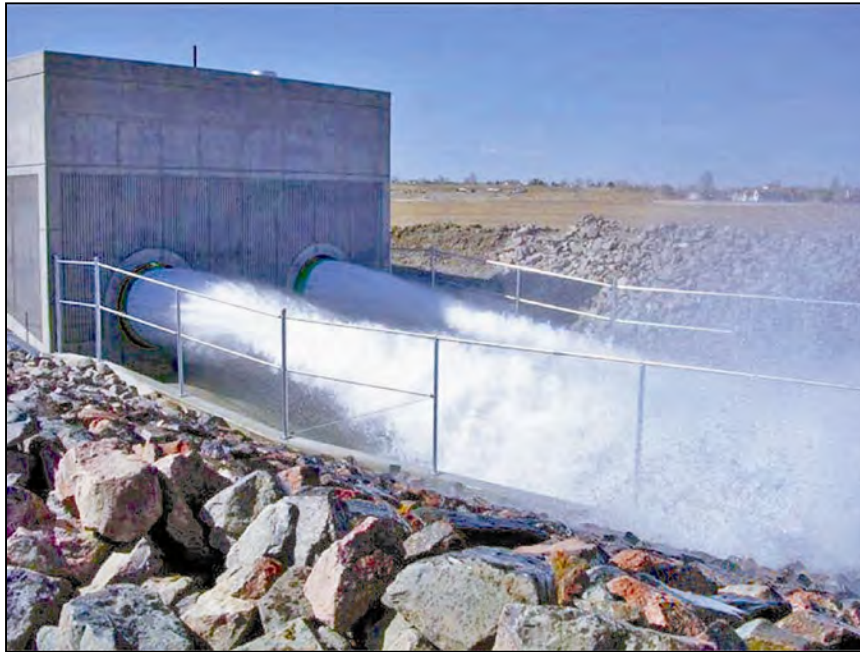

Figure A-101.—View of the stream release facility with both fixed-cone valves operating during testing at 20 percent opening (total of 167 ft<sup>3</sup>/s).



Figure A-102.—View looking upstream at the stream release facility with both fixed-cone valves operating each at 20 percent opening (total of 167 ft<sup>3</sup>/s).

**Lessons learned:**

After the completion of the outlet works, the stilling basin was subjected to discharges up to approximately 170 ft<sup>3</sup>/s. This maximum discharge for the testing was selected to minimize erosional damages to highway crossings downstream of the dam. This maximum discharge is well below the maximum design discharge, but well within the maximum normal operating discharges. Under the maximum design discharge, it is anticipated that some downstream damage will occur.

During testing of the outlet works, the stilling basin performed as designed and no detectable damage to the stilling basin was observed.

**Reference:**

CH2M Hill, “Standley Lake Dam Improvement Project,” Technical Memorandum TM 3.04, *Overall Configuration and Operation of the Outlet Works*, April 23, 2001.

## Outlet Works Energy Dissipators

---

**Project:** Twin Lakes Dam

**Location:** Colorado

**Summary:** CCTV Inspection of a stilling basin underdrain system

Twin Lakes Dam, constructed in 1978, is located on Lake Creek about 13 miles south of Leadville, Colorado. Twin Lakes Reservoir provides irrigation and recreational benefits and acts as the tailwater reservoir for the Mount Elbert Pumping Plant (pumped storage power generation). The dam is a 3,150-foot long, 100-foot high earthfill embankment structure (figure A-103).

Both the outlet works and spillway are cut and cover conduits beneath the dam. The outlet works stilling basin is an 83-foot long type II basin with two 14-foot wide bays that are separated by a central splitter wall.

The purpose of the October 2008 examination was to document and evaluate the condition of the outlet works stilling basin underdrain system, and to search for signs of possible zebra mussel infestation. Divers worked in conjunction with the CCTV operator to perform the inspection of the outlet works stilling basin's underdrain system. Underwater inspection of the stilling basin was also performed since the dive team was already on site. Observed conditions were documented by CCTV inspection (interior of the underdrains), and by sight, touch, measurement, and underwater photography (stilling basin).



Figure A-103.—Aerial view of Twin Lakes Dam.



The outlet works stilling basin underdrain system consists of 6-inch diameter perforated PVC pipe. The underdrain system has six outfalls located at the downstream faces of the six chute blocks located at station 12+36. The outlets were numbered 1 through 6 starting from the right wall and moving to the left wall (see [figure A-104](#)). This numbering corresponds to the order in which the underdrain outfalls were inspected.

A Subsea mini video camera ([figure A-105](#)) was used to inspect the underdrain system. The Subsea mini video camera is used to inspect pipes with diameters as small as 2 inches or pipes with obstructions that prevent use of a tracked camera-crawler. The Subsea mini video camera was attached to a stiff coaxial cable and manually advanced through the pipe by the divers stationed at the drain outfall.

The underdrain outfalls, the point of entry for the drainpipe inspection, all appeared open with no evidence of material exiting the drain ([figures A-106](#) and [A-107](#)). In underdrain No. 1 the camera was easily advanced beyond the first and second bends ([figure A-108](#)) with no obstructions observed ([figure A-109](#)). The camera was advanced downstream of the second bend (estimate 20 to 30 feet) at which point it was withdrawn by the divers. Only one instance of gravel (estimate  $\frac{3}{4}$ -inch diameter gravel) was noted in underdrain No. 1, at a T-intersection within the pipe downstream of the second bend ([figure A-110](#)).

In underdrains Nos. 2 and 3 the camera was advanced beyond the first and second bend. Gravel was observed at the first and second bend of these underdrains. The pipe in underdrain No. 2, at the second bend, had a rupture through which the gravel filter material around the pipe could be seen ([figure A-111](#)). Beyond the second bend for both of these underdrains there was a moderate amount of gravel within the pipe ([figure A-112](#)) beyond which the camera could not be advanced more than a few feet.

In underdrains Nos. 4 and 5 the inspection was halted at the first bend due to each pipe being completely filled with sand and gravel. Underdrain No. 6 had similar conditions as underdrain Nos. 2 and 3; however, underdrain No. 6 also contained a large cobble which was wedged across the entire diameter of the pipe beyond the second bend ([figure A-113](#)) and the camera could be advanced no further.

The divers then utilized a 4-inch diameter camera mounted on a sewer snake to reinspect the underdrain No. 6 outfall. This was to determine how well this larger camera would be able to negotiate the drainpipe bends. The divers were able to insert the camera up to the large cobble which had halted the smaller camera, but it should be noted that it was more difficult to advance this size of camera.

The drawings indicate there are drain outfalls at only the two outermost chute blocks. Additionally, the stilling basin drawing ([figure A-104](#)) only shows two longitudinal drains, located in line with these two outermost chute blocks and drain

outfalls. This raises the possibility that there is a similar amount of small rock material in each of the drainpipes, but that underdrain Nos. 2 through 5 only extend to the first cross drain at station 12+38 and that these pipes have nowhere for the rock to move downstream. This is one possible explanation for the difference in rock infilling among the drain outfall pipes. Prior to any analysis on these drainpipes, the existing construction records will need to be reviewed to determine the actual configuration of the underdrain system.

The divers surveyed the stilling basin floor to characterize the degree of erosion which the concrete has experienced ([figure A-114](#)). The floor condition appears to fall in two different conditions depending on location. Downstream of the joint at station 12+75.50 (roughly the midpoint of the stilling basin) the floor is eroded down to a level, exposed aggregate surface. The surface relief or roughness in this area is on the order of 1/8-inch.

Upstream of station 12+75.50, the floor is eroded to a higher degree. In this area the floor is not level; rather the surface undulates in the upstream to downstream direction giving it almost the appearance of waves in the concrete. The amplitude of these “waves” is on the order of 1-inch and the surface relief or roughness is 1/2- to 3/4-inch. In one location in the left bay floor there were two convex depressions in the floor where it appears that two pieces of rounded aggregate had been plucked from the surface after erosion had exposed the upper half of each stone. The concrete surface in this area was a slightly different color than the surrounding concrete paste. This is an indication that these stones had been relatively recently removed and is also an indication that the erosion in the basin is fairly current phenomenon occurring in the outlet works stilling basin. However, it should also be noted that no exposed reinforcement was found anywhere in the basin.

Heavier localized concrete erosion was found in the vicinity of the stilling basin chute blocks. This erosion was located between the chute blocks at the location where the sloping chute meets the horizontal stilling basin floor and included some erosion of the downstream vertical corner/edge of the chute blocks near the floor ([figure A-115](#)). Erosion in the floor in this area averaged about 2 inches with a maximum of 3 to 4 inches depth.

Only a small amount of erosive material was found in the basin. This material consisted mostly of scattered, rounded to subrounded cobbles. Some of these rocks were up to 10-inch diameter. In the right bay the floor coverage was less than 1 percent as the rocks numbered less than 10. The left bay had similar coverage with the exception of one localized pile of rock near the right wall. This pile could be contained in roughly two 5-gallon buckets. See [figure A-116](#) for a plan of the stilling basin showing the locations of the abrasion erosion.

In addition to the underdrain system, the divers searched the riprap directly downstream of the end sill of the stilling basin. There was no evidence of riprap



movement and all of the rocks were more than a foot below the end sill. The divers felt down between the individual boulders and could not locate any infilling of the riprap voids with rock matching the material located in the drainpipes during the CCTV inspection.

The size of rock in the stilling basin would be capable of abrading the concrete surface. Interestingly, it is unclear why the erosion upstream of the mid-basin joint is in an undulating or wavy pattern. One theory would be that the concrete is denser over the reinforcing bars due to some type of extra consolidation during vibration. This wavy eroded surface has been observed at one other stilling basin. The wavy surface at that site was located in each bay, just downstream of the erosional holes that were repaired in 2001. As it turns out the erosion was due to smaller erosive media (gravel) rather than cobbles. This raises the question: If this erosion pattern is due to smaller erosive material, could this be an indication of continued removal of smaller rock or gravel from the drains which is causing a portion of the damage? As previously discussed, the divers evaluated the riprap directly downstream of the basin and found no deposits of this type of material.

The outlet works stilling basin appears to be in satisfactory condition. However, portions of the basin are showing abrasion erosion. While there is no exposed reinforcing steel in the eroded areas, some erosion is on the order of 4 inches deep and may soon begin to show reinforcing steel exposure. Of interest, the abrasion erosion in the upstream half of the basin is undulating or wavy. While there is no evidence of smaller sand/gravel in the basin or directly downstream in the riprap, it was this type of erosive material which caused extensive damage at another site, and the erosion at that site also exhibited a wavy surface.

Successful cleaning of the underdrain system using high pressure water jetting would be difficult due to the numerous pipe bends and the submerged condition and could be harmful given the observed ruptures in the pipe.

**Lessons learned:**

Consideration should be given to more frequent underdrain/stilling basin inspections until the potential impacts can be determined. The possibility of installing and anchoring CCTV cameras to allow for inspection of the drains during a short period of operation should be considered as a means of evaluating movement of material in the underdrains.

**Reference:**

Bureau of Reclamation, *Underwater and Remote Camera Examination, Outlet Works Stilling Basin and Underdrain System and Spillway Stilling Basin, Twin Lakes Dam, Fryingspan-Arkansas Project, Colorado*, October 20, 2008.

Outlet Works Energy Dissipators

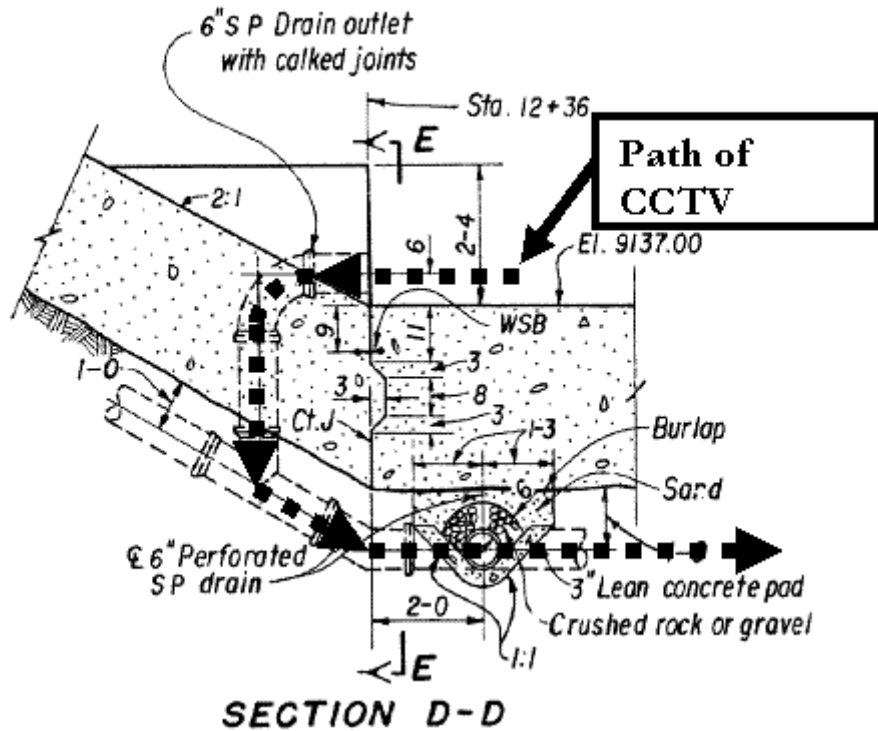
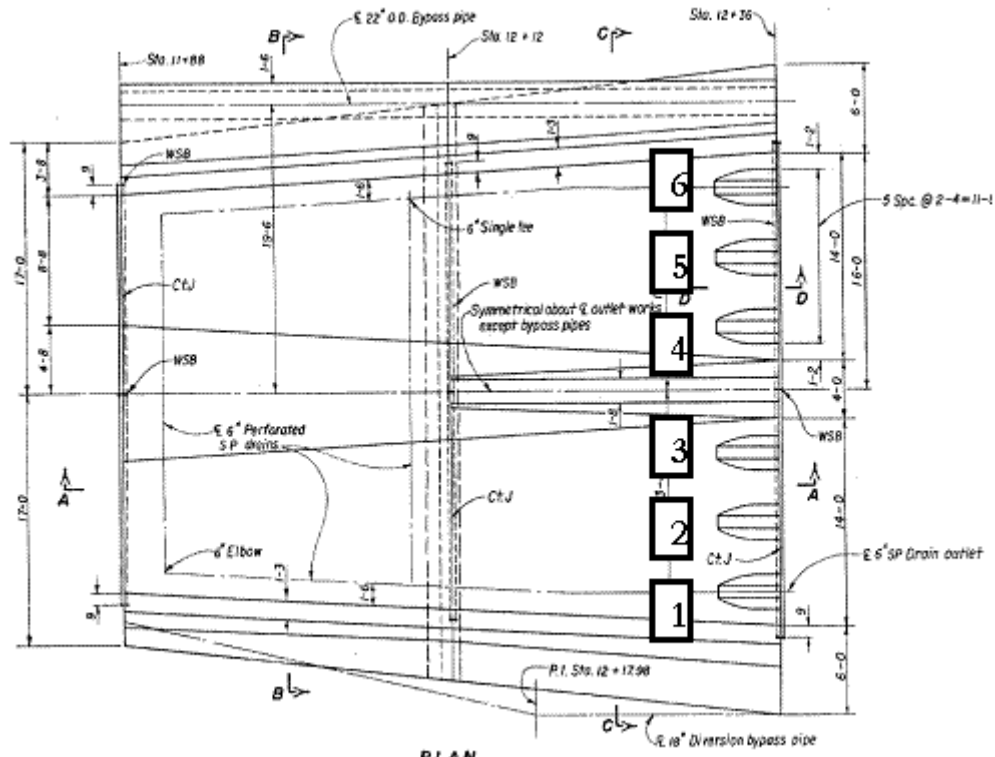

Figure A-104.—Underdrain layout and path of CCTV inspection.



Figure A-105.—Subsea mini video camera used to inspect small pipes. Note the 16 LED light sources surrounding lens.



Figure A-106.—Typical condition of downstream face of outlet works stilling basin chute block and 6-inch diameter PVC drain outfall.



Figure A-107.—Typical condition of drain outfall in downstream face of outlet works stilling basin chute block. Note minor damage to exposed edge of PVC drainpipe likely due to movement of material in basin during releases.



Figure A-108.—View of the first bend inside Underdrain No. 1 (rightmost drain) in the outlet works stilling basin. Image was taken from pipe inspection video.



Figure A-109.—View looking vertically downward at the second bend inside Underdrain No. 1 (rightmost drain) in the outlet works stilling basin.



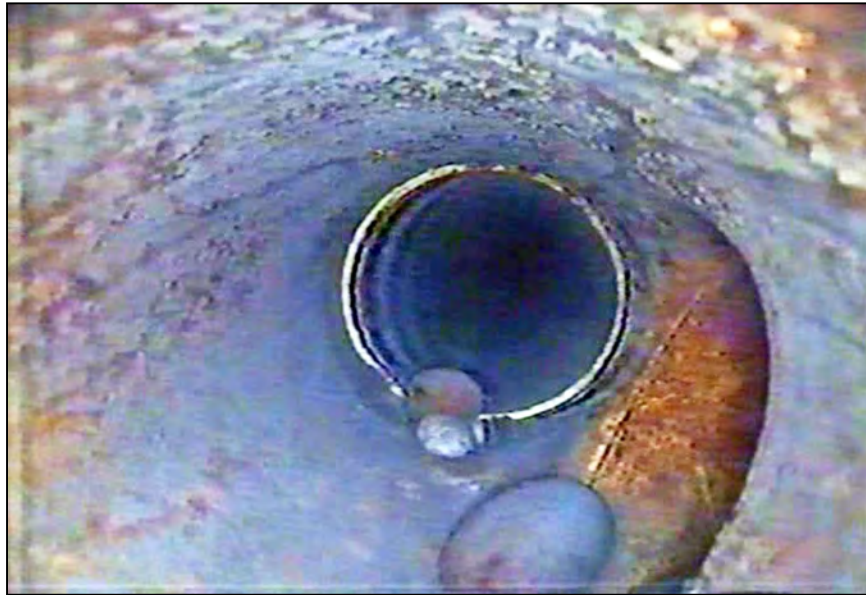

Figure A-110.—Isolated gravel in Underdrain No. 1 at T-intersection with pipe just downstream of second bend (location where pipe becomes horizontal).

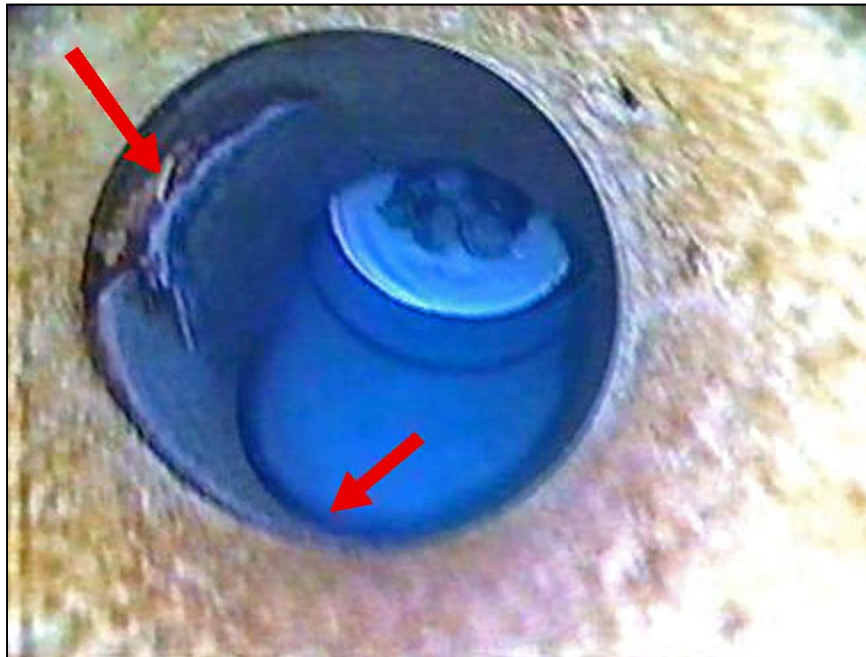

Figure A-111.—Visible rupture (upper arrow) in the side of the pipe wall of Underdrain No. 2 at the second bend. Lower arrow indicates visible entrance of upstream drain beneath the chute.





Figure A-112.—Typical condition of Underdrain Nos. 2 and 3 downstream of the second bend, where camera could no longer be advanced.

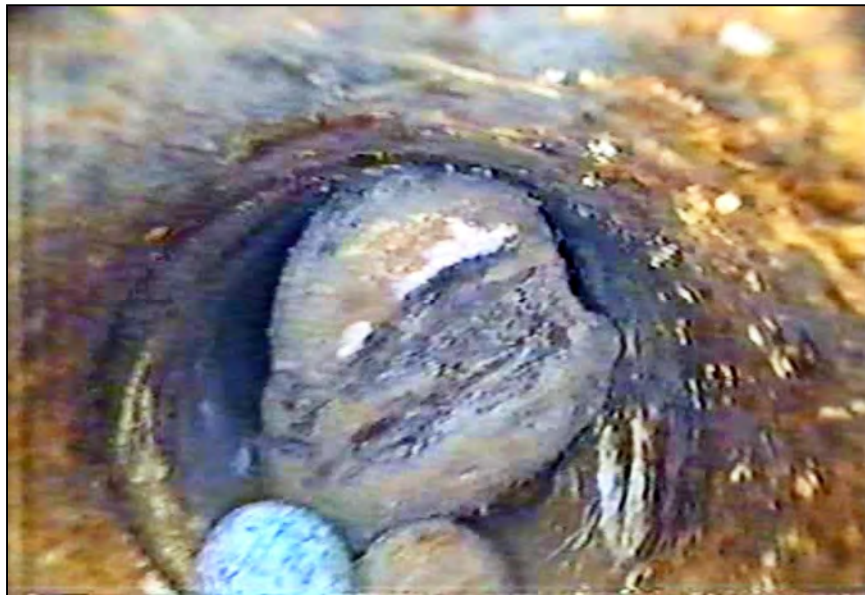

Figure A-113.—Underdrain No. 6 showing cobble blocking the 6-inch diameter PVC pipe just below the second bend.



Figure A-114.—Cobble located in left outlet works bay near chute block. Large arrow indicates location where erosion of downstream corner/edge of chute block and floor slab are visible (Note joint along base of chute block at original floor slab denoted by small arrow).



Figure A-115.—Localized erosion between two chute blocks in the outlet works left bay. Note that the ruler is resting on concrete at each chute block and spanning (about 2½ inches above concrete) eroded area in the floor.

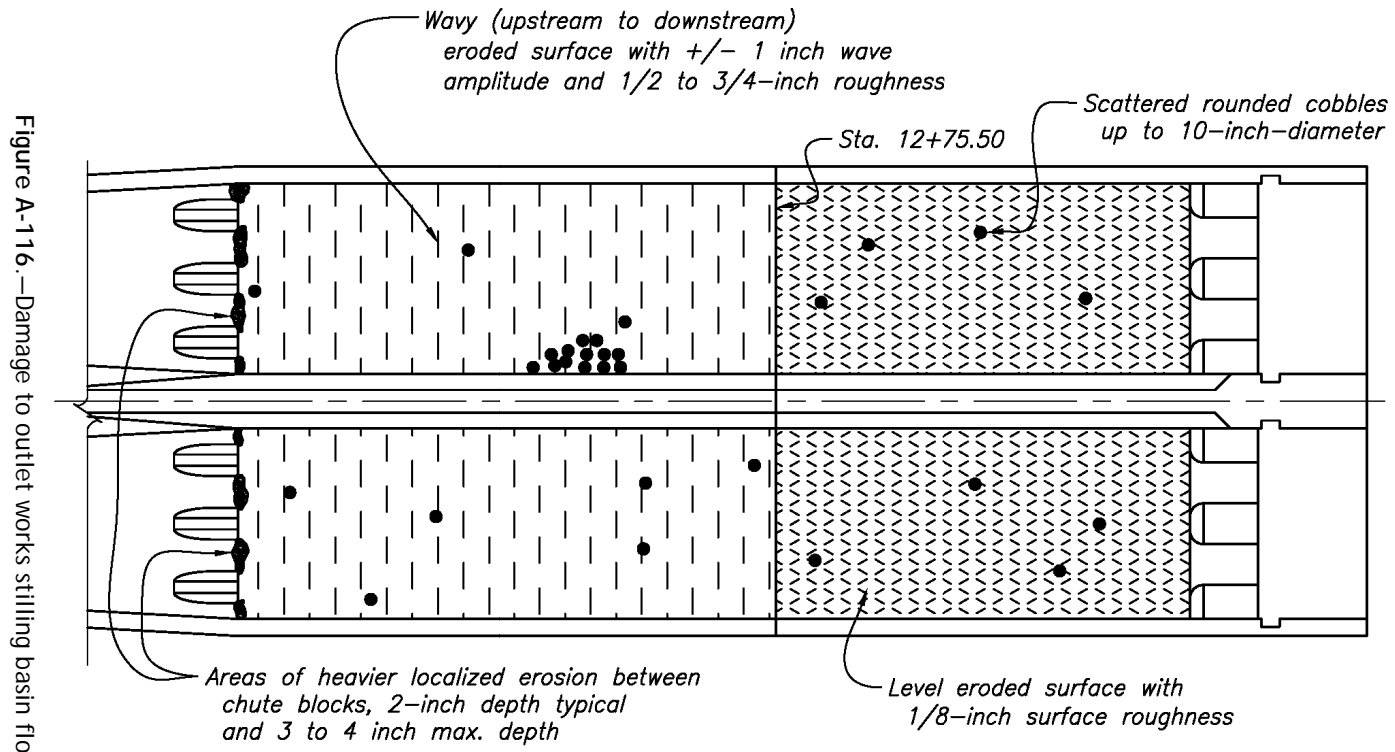

Figure A-116.—Damage to outlet works stilling basin floor.

**PLAN — TWIN LAKES DAM OUTLET WORKS STILLING BASIN**  
Showing locations of damage  
10-20-2008 underwater examination



**Project:** Virginia Smith Dam

**Location:** Nebraska

**Summary:** Dive inspection reveals stilling basin damage and requires repairs to be performed

Virginia Smith Dam is located across the Calamus River about 5.5 miles northwest of Burwell, Nebraska. The dam is constructed of rolled earthfill with a maximum height above streambed of 95 feet and a crest length of 7,295 feet. The elevation of the dam crest is 2,259.0 feet. The embankment volume is about 6 million yd<sup>3</sup>. At the time of the inspection, the water surface elevation of the reservoir was approximately 2243.9 feet.

The river outlet works, is a steel lined, cut-and-cover conduit through the embankment, near the right dam abutment. The intake structure is a 25-foot square, reinforced concrete box with two sets of 8-foot wide trashracks on each of the three upstream sides and the top. Downstream of the trashracks there is a bell mouthed inlet, a 10-foot diameter upstream conduit, a 6-foot 6-inch by 10-foot high pressure emergency gate located in the gate chamber below the dam crest, a downstream 9-foot diameter steel conduit inside an oversized horseshoe conduit, a bifurcation to the Mirdan Canal, a second bifurcation, two 5-foot by 6-foot high pressure regulating gates in tandem, and a type II stilling basin with two bays. The stilling basin (figure A-117) is 88-feet 6-inches long and each bay is 10 feet wide. The

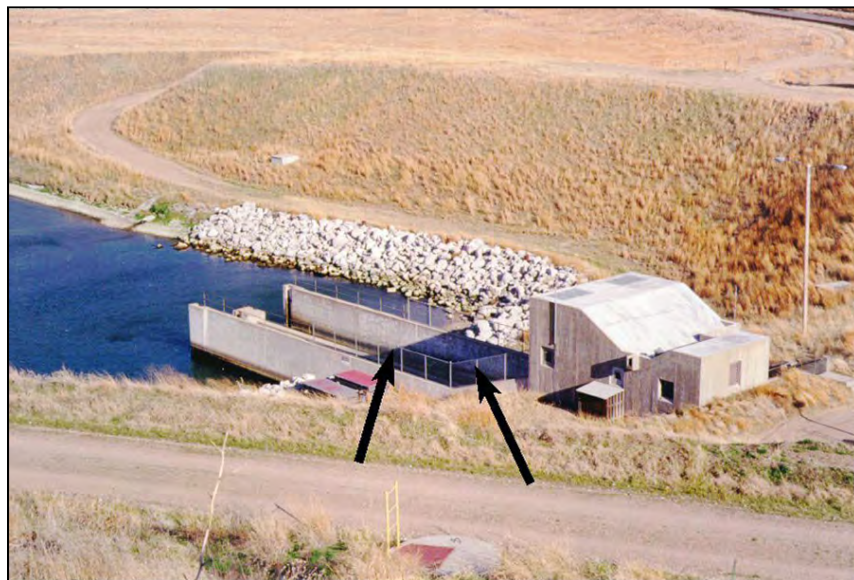

Figure A-117.—View of river outlet works stilling basin from left side. Arrows denote approximate location (on right wall) of exposed reinforcing steel.

center dividing wall is 5 feet thick at the base and extends the full length of the basin. Each bay of the basin is equipped with three 2-foot high, 1-foot 9-inch wide chute blocks at the downstream end of the chute. The two outer chute blocks in each bay has a 10-inch underdrain outfall. The 4-foot high dentated end sill extends 9 feet upstream of the end of the basin. Each bay has one 2-foot 6-inch wide dentate in the center and two half width dentates built into the walls on each side. There is a stoplog slot built into the end of each bay of the basin. The basin floor was constructed at elevation 2151 feet.

The purpose of the April 2000 dive examination was to document and evaluate the underwater condition of the river outlet works stilling basin. The ambient temperature was 60 °F. The maximum diver depth in the basin area was 19 feet with a water temperature of 51 °F.

Lockout/tagout procedures were implemented on the outlet works prior to the dive inspection. The gates were locked in the closed position. Underwater visibility was approximately 2 feet in the stilling basin. There had not been any previous underwater inspections at Virginia Smith Dam.

The river outlet works is operated year-round due to river flow requirements and in the past has discharged in excess of 600 ft<sup>3</sup>/s. The regulating gates are typically operated in a balanced condition, one half of the total flow passing through each gate.

The dive inspection revealed that the concrete in the floor of the river outlet works stilling basin was in extremely poor condition with extensive abrasion erosion of the floor in both of the bays (figures A-118 and A-119).

In the right bay, there was exposed reinforcement extending approximately 28 feet, from about station 33+45 to station 33+73. Based on stains above the water line on the wall, this location is roughly the same as the surface expression of the hydraulic jump in the basin (figure A-120). At the deepest, this abrasion erosion extends approximately 16 inches below the top reinforcement which is supposed to have 6 inches of concrete cover. Therefore, the maximum erosion in the right bay is about 22 inches, almost half of the 4-foot design thickness of the basin floor (figure A-121). The area of exposed reinforcing steel is roughly elliptical in plan view as the upstream and downstream portions are narrower while the central portion extends roughly from one wall to the other. The depth of erosion is less toward the ends of the exposed reinforcement area with the upstream most and downstream most bars only exposed on the top and still embedded on the bottom side. In this area, virtually all of the longitudinal top face steel is gone. While the transverse steel is still in place, it has been severely abraded such that the rebar diameters are considerably reduced and there are no longer any visible bar deformations.

Outlet Works Energy Dissipators

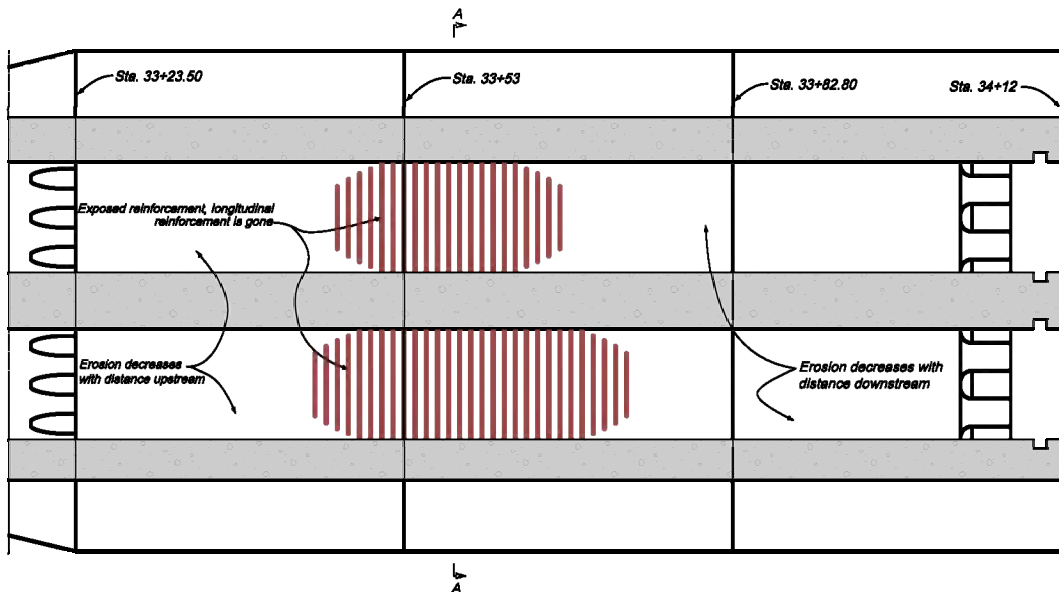

**PLAN SECTION OF RIVER OUTLET WORKS STILLING BASIN  
(Cut near floor elevation)**

Figure A-118.—Plan of the stilling basin.

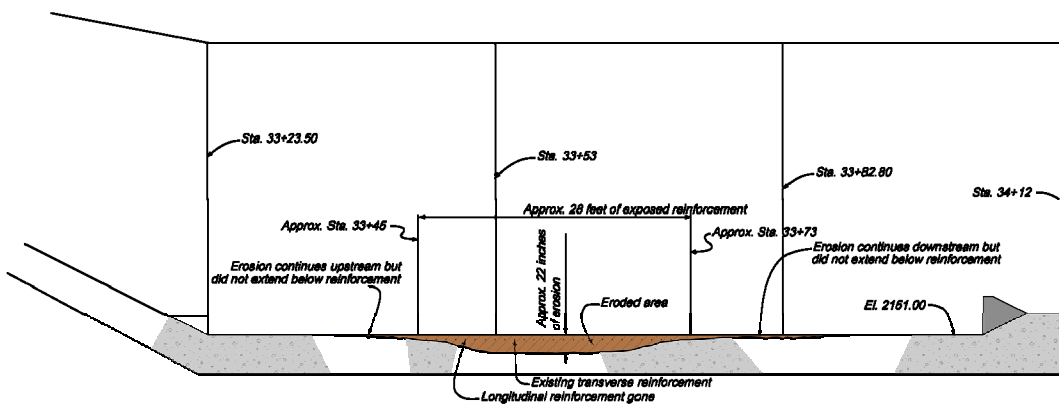

**PROFILE ALONG THE RIGHT BAY OF RIVER OUTLET WORKS STILLING BASIN  
(LEFT BAY SIMILAR, 20 FEET OF EXPOSED REINFORCEMENT, 15 INCHES DEEP)**

Figure A-119.—Profile of the stilling basin.



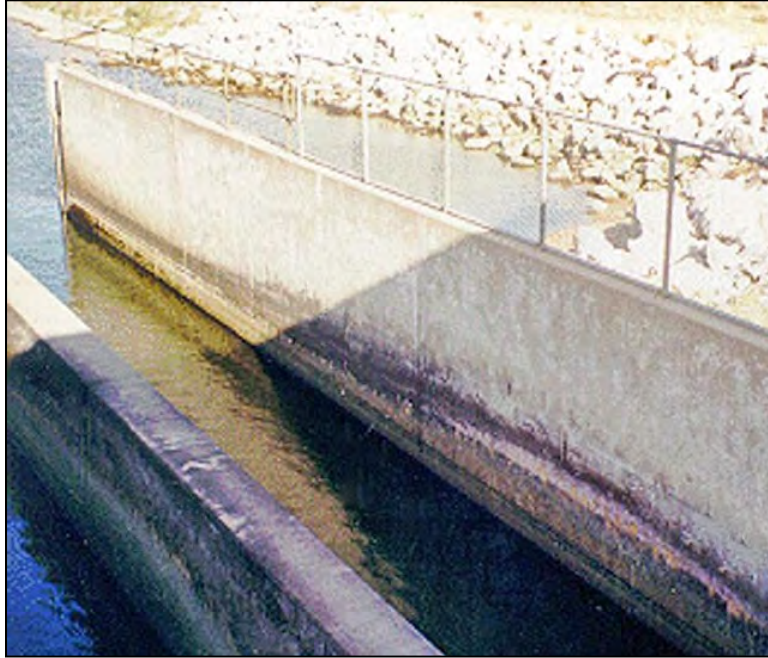

Figure A-120.—Close-up of right wall of river outlet works stilling basin. Arrows denote area of staining from hydraulic jump which roughly corresponds to area with exposed reinforcing steel in floor.



Figure A-121.—Abrasion erosion which occurred on the basin floor.

## Outlet Works Energy Dissipators

---

The remaining bars vibrated considerably during discharges as they have worn conical openings around themselves where they enter the eroded concrete surface (see [figure A-122](#)). These conical openings could be probed with a plumber's rule to a depth of 8 inches. Due to the thickness of this type of rule it is likely that these openings extend significantly further than this 8-inch dimension. At the eroded face of the concrete, the holes around the bars are about 3 bar diameters across. Abrasion erosion of the floor is visible both upstream and downstream of the exposed steel area and seems to decrease with distance from the exposed steel area. The eroded concrete in these areas had up to 3 inches of relief and a wavy, undulating surface.

In the left bay, the damage was similar, but not quite as extensive as in the right bay. Located at what appears to be the location of the hydraulic jump, the area of exposed bars was about 20 feet long. The maximum depth of erosion was about 9 inches below the reinforcement making the maximum depth of erosion below the original basin floor approximately 15 inches. Similar to the right bay, the bars had holes around them due to vibration of the bars. The abrasion erosion extended upstream and downstream of the area of exposed bars.

There were no rocks found in the basin which would indicate ball milling. There was little in the way of loose material in the right bay. The left bay had accumulations of coarse sand up to 3 inches deep in portions of the eroded area. The grains of sand tended to be rounded and smooth. There was no indication, if this sand was initially only in the left bay or if the sequencing of valve shutdown prior to the inspection had created currents which pushed all of the sand into the one bay. Downstream of the basin there was no evidence of rounded, sub-rounded, or even sub-angular rock which could have been interpreted as possible medium for abrasion erosion in the basin. All of the downstream rock appeared to be angular riprap with sand infilling between the rocks. Based on this, it appears possible that the concrete erosion is due



Figure A-122.—Vibration caused the conical openings around the portion of bars remaining in concrete.

to a “sandblasting” action with coarse sands which are being pulled back into the basin (figure A-123). Another possible source of erosive materials to enter the basin is from the underdrain system as discussed in the [Virginia Smith case history on page A-152](#).

The chute section and the chute blocks appeared to be in good condition. The concrete showed little evidence of abrasion erosion. This, in addition to the lack of sand at the intake, seems to indicate that there is not a condition where the sand is being introduced to the basin from upstream through the outlet works during operational releases. The underdrain outfalls located in the chute blocks were all located. These outfalls were open and the water from these drains was clear as opposed to the cloudy water in the rest of the basin. The vortices created by the mixing of these two water sources could be seen, indicating that the drains were flowing.

The dentated end sill showed little abrasion erosion. The concrete surfaces on the dentates were smooth and the chamfers and edges were sharp and clean. The stoplog slots and seats at the ends of each bay were in satisfactory condition. There was no evidence of undercutting of the end sill as the riprap, with sand infill, was in contact with the end of the concrete structure.

Before attempting any repairs to the damaged stilling basin, it was analyzed to determine the possibility of collapse should one bay at a time be unwatered for the repair activities. The structure was modeled using structural analysis software STAAD III. This program allowed the interaction of the soil foundation to be modeled as a series of springs which correlate to the foundation modulus of the underlying sand and silty sand. Results from the STAAD III analysis were used as input moments and applied to the structure to study the reinforced section under biaxial bending. The actual compressive and tensile stresses experienced by the concrete and reinforcing steel were then determined. The results of this study



Figure A-123.—The exposed aggregate has been polished smooth by erosion.

demonstrated that in its present condition, the stilling basin cannot be safely unwatered one side at a time without collapsing the center wall and floor.

### **Lessons learned:**

Extensive erosion of the floor of both bays of the basin has extended below the top face reinforcement, removing the longitudinal bars and rendering the transverse bars useless in a load carrying role. The abrasion erosion extended 22 inches deep in the right bay and 15 inches deep in the left bay. In the right bay this accounts for erosion through nearly half of the original 4-foot thickness of the slab. Damage due to vibration of the remaining bars extends back under the walls in excess of 8 inches at the bar locations. Although it had not yet reached the reinforcing steel, the abrasion erosion of the floor extends both upstream and downstream of the large holes. Evidence such as: the lack of rounded, sub-rounded or sub-angular rock in and around the basin; detection of rounded coarse sands both in and downstream of the basin; and the lack of damage on the chute section, seemed to indicate that the damage is possibly due to “sandblasting” with sand which is being pulled by currents back into the basin from downstream. The chute blocks, chute floor, dentated end sill, and stoplog slots are in satisfactory condition. The underdrains outfalls are open and flowing.

Due to loss of the top face reinforcement for the slab and nearly half of the slab thickness, continued deterioration could lead to failure of the structure. Once repair is completed, a more frequent yearly inspection schedule should be considered for the basin, until determination can be made that the repair has alleviated the erosion problem.

Consideration should be given to installation of some type of monitoring pins in the repair section such that future monitoring of this area can be more accurate and detailed.

Future underwater inspections at this site should be conducted as early in the season as possible, preferably before May due to possible algae bloom restricting visibility severely after that time. Since operations at the dam require that after June 1 all reservoir inflows be passed through the river outlet works, underwater inspections should be scheduled prior to this date.

Regular inspection of stilling basin should be continually performed. Underwater inspection is especially important prior to any basin unwatering.

**References:**

Bureau of Reclamation, *Underwater Examination, Virginia Smith (Calamus) Dam, Outlet Works Intake Structure and River Outlet Works and Spillway Stilling Basins, April 26, 2000, North Loup Division, Pick-Sloan Missouri Basin Program, Nebraska*, June 13, 2000.

Bureau of Reclamation, *Stability Analysis Report, River Outlet Works (ROW) Stilling Basin Repair—Virginia Smith Dam, Nebraska*, September 28, 2000.



## Outlet Works Energy Dissipators

---

**Project:** Virginia Smith Dam

**Location:** Nebraska

**Summary:** Detection of internal erosion beneath a stilling basin and the subsequent repairs

Virginia Smith Dam is located across the Calamus River about 5.5 miles northwest of Burwell, Nebraska. The dam is constructed of rolled earthfill with a maximum height above streambed of 95 feet and a crest length of 7,295 feet. The elevation of the dam crest is 2,259.0 feet. The embankment volume is about 6 million yd<sup>3</sup>.

The river outlet works has a discharge capacity of 2,460 ft<sup>3</sup>/s and consists of a trashrack, inlet transition, and a 10-foot diameter steel-lined conduit to a 6.5- by 10-foot outlet gate installed in a gate chamber 30 feet upstream from the dam axis. Downstream of the gate chamber is a 9-foot diameter steel pipe encased in concrete terminating in a wye branch, with each branch containing two 5.5-foot, high pressure gates in control houses. Figure A-124 shows the river outlet works stilling basin.

One branch of the wye carries water to the canal outlet works. This branch can discharge 720 ft<sup>3</sup>/s into the Mirdan Canal when the reservoir water surface is at the bottom of the conservation capacity, elevation 2213.3 feet. After passing through



Figure A-124.—River outlet works stilling basin and control house at Virginia Smith Dam.



high pressure gates, the water goes through a wave suppressor and a 20-foot wide Parshall flume. Beyond the flume, the water enters the canal at water surface elevation 2206.5 feet. The other branch of the wye controls the water required for returns to the Calamus River. The branch to the river is also used to discharge part of the inflow design flood. Beyond the high pressure gates is the stilling basin.

On December 18, 2002, a smaller, 2.5-foot diameter depression was reported adjacent to the right side of the river outlet works gate house/stilling basin at approximately Sta. 33+03. The depression could easily be probed to a depth of 18 feet with a piece of reinforcing steel. On February 4, 2003, the depressed area was partially excavated by the Twin Loups Irrigation District personnel under the direction of Reclamation personnel. This excavation extended downward approximately 8 feet (limit of excavation without shoring or benching of the excavation) and no open void was located. Probing the bottom of the excavation (figure A-125) showed that the material remained extremely soft for a minimum of 18 feet further (length of probe available). Due to the nature of the fill in this area, a major concern was that the base slab of the dissipation structure had formed a roof for a void under the structure.

Further exploration of the depression area would require extensive dewatering and shoring in the area of the depression. Under this scenario, the removal of the fill and the associated loading from one side of the basin while the other side remained loaded by fill could result in a rotational or settlement failure of the structure into the void area. A decision was made that prior to any major excavation adjacent to the structure, some type of exploration into the possibility of voids beneath the structure should be undertaken and their possible impacts mitigated. Due to the thickness and heavily reinforced nature of the chute and basin slab, the use of either acoustic testing or ground penetrating radar was ruled out. The decision was made that a program of exploratory drilling through the chute slab would be undertaken in an attempt to locate any voids. In the event that voids were located, a program for backfill grouting for the voids was also planned.

Releases through the outlet works were shutoff, the underdrain outlets were plugged, and the stilling basin was unwatered. The drilling program was initiated near the outer wall of the right bay just downstream of the regulating gate. From this spot, the planned progression for the drill holes was at the same station and across the structure until the drillers reached the outer left wall. From there the drillers moved downstream to the next row of holes and moved back across the structure. In this manner, the drillers progressively moved downstream, one row at a time. This allowed the drillers to progressively work from areas that had lower groundwater pressures to areas that had higher groundwater pressures. The drill hole pattern was



Figure A-125.—The depression is being probed to determine its depth.

laid out in an attempt to cover as much of the chute portion of the structure as possible and encounter any void that could be under the structure and at the same time minimize the amount of reinforcing steel that the drillers would have to drill through.

A total of 20 three-inch diameter holes were drilled through the floor ([figure A-126](#)). Thickness of the concrete ranged from 3.6 to 4.6 feet. Voids beneath the floor slab were found in 14 of the drill holes, ranging from 0.2 to 1.3 feet in depth. A closed circuit camera with a side-wall viewing prism was inserted into the drill holes in an attempt to visually inspect the suspected void. In some drill holes there was a considerable rush of sand and gravel material issuing from the hole. When possible, a camera was used to view the extent of the voids around the entire perimeter of the bottom of the hole. Also visible using the camera was a slow movement of the water in a downstream direction. This was visible due to a small amount of very fine particles (believed to be concrete cuttings) which could be seen moving. Some voids seemed to be continuous between drill holes. Grout packers were inserted and worked down into the holes to prevent movement of foundation material with the seepage.

The grouting consultant arrived on site on March 16. With the progression of the drilling work it was decided that the next day would be used to dye test the holes



Figure A-126.—Drill crew drilling a hole in right bay of stilling basin.

through the structure in an attempt to better understand the void system and tailor a grouting program to best address closure of the voids. The best approach to filling the voids and/or isolating them from an exit point was likely going to involve plugging of and removing from service the entire underdrain system. The drill crew began laying out the grout pump and grout lines to begin dye testing in the drill holes. The irrigation district supplied the dye to be used. After extensive discussion it was decided special attention needed to be given to observing underwater portions of the surrounding channel for signs of seepage exiting from foundation during the dye tests. At this time it was still undecided what direction to grout, but it was hoped that the dye tests would give some indication.

Dye testing commenced late in the morning with the hoses connected at the downstream drill hole on the right bay near the bottom of the chute. After 13 minutes of pumping dye, dye appeared in drill hole located at the uppermost end of the right bay for about 7 minutes after which it flowed clear again. After pumping 1,800 gallons of dye into the drill hole near the bottom of the chute, no other dye appeared anywhere.

In the afternoon, a different approach to the dye testing was undertaken. This time the hose was hooked to the packer at drill hole DH-02 in the upper right bay and 500 gallons was pumped. This time the blue dye showed up in a short time in all of the holes. The order in which the dye showed up in the holes supported the idea that the water was traveling downstream beneath the structure.

Based on the results of the dye testing it was decided that with the flow in the void and drains there was no way to push the dye upstream from below in the present condition. Without some way to maintain an injection pressure at the downstream portion of the basin, the dye was simply being pushed downstream through the drains and into the groundwater. Because of this, and concerns with the grout being stopped behind a temporary plug (self healed section) of the foundation, it was decided that the grouting should first plug off the drain system. After this had occurred, the grout could be pushed under pressure upstream against the flow of the ground water. In effect, the grouted drains (the lowest point in the void/drain system) would give the grout something to “push against” as it traveled upstream and upward. To do this right, it was decided that four additional holes be located in the basin floor such that the pipes could be grouted with a minimum of pressure since this portion of the structure has the least amount of fill surrounding it and would be most susceptible to a grout blowout or lifting of the structure.

With completion of the grout hole drilling, the drill crew began setting up the grout pumps (figure A-127), hoses and manifold for grouting the next day. A makeshift monitoring system for the downstream portions of the basin was devised, since the original plans did not consider grouting in the lower reaches of the basin, no provisions were made for monitoring this area during a grouting program.

The grouting was initiated on the right side at the downstream end of the basin. The maximum sustained grout pressure used was 15 lb/in<sup>2</sup>. However, this was only necessary when the grout hole neared refusal. For the most part, the grout was flowing into the holes at up to 30 gal/min with only 1 to 2 lb/in<sup>2</sup> above backpressure. The grout mix was a neat cement grout with a 1:1 water-cement ratio by volume and 12 ounces of superplasticizer per bag of cement. Figure A-128 shows the grouting operations being performed.

A total of 58 yd<sup>3</sup> of grout were pumped into the drains and foundation. During the grouting process heavy grout return was experienced through the air vent openings in the walls and these were plugged off with felt. Rough calculations prior to grouting indicated that the drain system would take up to about 47 yd<sup>3</sup> based on the design drawings and an assumption that the crushed rock around the drain pipes consisted of about 40 percent void space. However, it is unlikely that all of the void space within the crushed rock was filled. The estimated yield (after water had been pushed from the grout) was at least 1.25 ft<sup>3</sup> of hardened grout per 1.5 ft<sup>3</sup> of grout





Figure A-127.—Grout pumps located at access road by gate house. White pump was used for grouting and the orange pump was on site as backup pump.



Figure A-128.—Grouting of the upstream chute.

injected (about 83.33 percent). Based on this the total volume of void/drains filled was about 48.33 yd<sup>3</sup>. There is no way to tell how much of this grout went into filling the drains and how much into filling the voids, however there was a considerable amount of the material which was pumped after the drain system was full.

During the entire grouting process the monitoring instruments were observed for signs of movement of the structure. Additionally, two individuals were on the barge downstream of the basin observing the material surrounding the basin (figure A-129). A wooden box was used with a clear plexiglass bottom that allowed the observer to clearly see if any boils or blowouts occurred adjacent to the structure (due to the fact this work was so early in the spring there was very little organic matter to obstruct the viewer from seeing the bottom). No blowouts or boils were observed (however, monitoring for boils was to continue as a short term monitoring requirement). At the very end of the grouting process there was an indication from one tiltmeter that there had been a very small movement of the upstream left wall near the gate house. This amounted to about 0.05 degree of rotation inward. This was taken as a good indication that the grouting had successfully filled the void and possibly pressurized the entire void surface. For movement like this the pressure would have to be distributed over the majority of the surface below the structure. This reading did return to the previous range of readings the next day. This could be an indication of a problem with the sensor or that the looser foundation beneath the structure slowly consolidated such that the structure returned to its previous location.

A verification drilling program was developed. The approach selected was to try and drill two holes along the uppermost cross drain alignment to verify that the voids had been plugged. This would show that the underdrains were plugged and that the voids surrounding them also had been plugged without entering a large interface with the foundation. There was debate concerning drilling further up the slope, but concerns arose as to whether it could be determined without drilling all the way into the foundation and initiating further removal of material and causing a new void. Two grout verification holes were drilled and later grouted closed. The grouting program resulted in grouting of most if not all of the stilling basin underdrain system. This was confirmed by drilling of the verification holes. The grouting program eliminated all known uncontrolled exit points for movement of material.

All drill holes were dry packed upon completion. Also, the underdrain outfalls were grouted off and in the process it was determined that there were no sizable flow paths in these. Six piezometer holes were drilled in the full/foundation surrounding of the structure to monitor potential changes in water pressures as a result of the grouting program. The basin was later rewatered and has performed satisfactorily since. Monitoring to ensure continued safe performance was increased after the completion of construction.





Figure A-129.—Barge used to monitor for grout blowout through foundation.

#### Lessons learned:

Stilling basin underdrain systems require careful design and the recognition that even modern dams designed according to accepted practices can be subject to internal erosion (particularly when erodible soils are present).

Based on the results of the drilling program, it is believed that there was an extensive void or system of voids beneath the outlet works stilling basin chute. Also, it is believed that the void(s) resulted from foundation material entering the drain system through either a broken pipe or due to a compromised section of the crushed rock surrounding the pipe. During the grouting process there were no external grout leaks from the surrounding channel. This is an indication that the material removed from the foundation in forming the void, likely was moving out through the chute blocks at the base of the chute. If leakage of grout or even dirty water was observed during the grouting process, this would have raised more concern surrounding the direct connection of the void area to the downstream channel. However, there was no evidence of this as a result of any of the activities.

Based on the amount of grout, the progression of grout return and the results of the verification drilling program, the void(s) have been filled as well as possible at this time. Additionally, the tiltmeter readings that indicated a slight uplift of the left side also indicated that the entire surface below the structure had been pressurized. These readings did return to the previous range, but this could be due to the consolidation of the soft foundation materials beneath the structure. This reinforces

the delicate balance necessary for such a grouting program where enough pressure is required to fill all the voids while not causing the structure to float. There may be some small isolated voids still located beneath the structure, however these no longer are believed to have an uncontrolled seepage exit point. As a result, any of these small remaining voids should be unable to grow and threaten the stability of the structure.

There has been no evidence thus far that the removal of the drainage system from operation and the associated change in the seepage around the structure has resulted in higher exit gradients in the channel around or downstream of the stilling basin. This structure will require an increased monitoring program for the remainder of its life.

The underdrain system may have been the source of erosive materials which damaged the basin floor as discussed in the [Virginia Smith case history on page A-144](#).

### **Reference:**

Bureau of Reclamation, *Travel Report: Exploratory Drilling and Backfill Grouting of Virginia Smith Dam*, April 2003.

**Project:** Xiaolangdi Dam

**Location:** China

**Summary:** Inline orifices

The Xiaolangdi Dam (figure A-130) is located on the Yellow River in Jiyuan, Henan, China. The dam stands 505 feet in height with a crest length of 4,321 feet. The 1,836-MW Xiaolangdi Project was completed in 2000, and generates 5.1 billion kWh of electricity a year. The project is the largest of its kind on the Yellow River and is second only to the Three Gorges project on the Yangtze. The project has multiple purposes including: flood control, ice control, dredging, industrial and municipal water supply and hydroelectric power. The project includes underground generating units and silt-discharge channels. During the flood season, the units operate with sediment-laden flow under extremely adverse conditions. Pioneering coating techniques were employed to protect the components from erosion in the heavily silt-laden water. The plant is only utilized at full capacity at periods of peak demand and during the flood season. At most times, only two of the six generators are on line to limit water discharge to 1,300 ft<sup>3</sup>/s.

A large diameter construction diversion tunnel was used at the Xiaolangdi Hydraulic Project as a low level temporary outlet works in 1998 (similar to [Mica Dam](#)). The maximum discharge rate is 20,200 ft<sup>3</sup>/s. The main conduit diameter (original diversion tunnel) was 47.5 feet. Unlike Mica Dam, a new intake had to be constructed and tied into the original tunnel, and flow is controlled instead from the



Figure A-130.—Aerial view of Xiaolangdi Dam.

downstream end by a tainter valve. Three sharp-crested inline orifices were installed upstream of the valve in the original tunnel. Velocities up to 68 ft/s pass through the orifices (Zhang and Cai, 1999). A control tainter gate is provided at the downstream end.

### **Lessons learned:**

A physical model (1:60 scale) was used for testing to better understand the complex hydraulics involved in the design. See [figure 120](#) in the main body of this manual for a design schematic.

### **References:**

Zhang, Z. and J. Cai, "Compromise Orifice Geometry to Minimize Pressure Drop," *ASCE Journal of Hydraulic Engineering*, HY 11, November 1999.