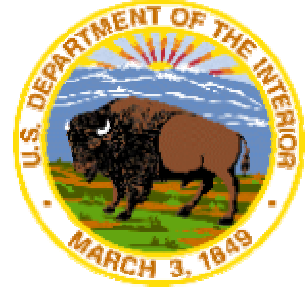




Water Resources
Research Laboratory



U. S. Department of the Interior
Bureau of Reclamation

WATER MEASUREMENT MANUAL

A WATER RESOURCES TECHNICAL PUBLICATION

A guide to effective water measurement practices for better water management



[U.S. Department of the Interior](#)

[Bureau of Reclamation](#)

In cooperation with



United States Department of Agriculture



FIRST EDITION 1953
SECOND EDITION 1967
REPRINTED 1967, 1971
REVISED REPRINT 1974
REPRINTED 1975, 1977, 1981
REVISED REPRINT 1984
REPRINTED 1993
THIRD EDITION 1997
REVISED REPRINTED 2001

For sale by the Superintendent of Documents, U.S. Government Printing Office, Washington, DC 20402.

As the Nation's principal conservation agency, the Department of the Interior has responsibility for most of our nationally owned public lands and natural resources. This includes fostering sound use of our land and water resources; protecting our fish, wildlife, and biological diversity; preserving the environmental and cultural values of our national parks and historical places; and providing for the enjoyment of life through outdoor recreation. The Department assesses our energy and mineral resources and works to ensure that their development is in the best interests of all our people by encouraging stewardship and citizen participation in their care. The Department also has a major responsibility for American Indian reservation communities and for people who live in island territories under U.S. Administration.

PREFACE

The mission of many public and private water resources organizations is to manage and conserve existing water supplies. These management efforts involve making sound technical and economic decisions concerning new and existing water needs, while respecting the environment by sustaining or restoring the aquatic ecosystems which may be affected. One key to better management practices, including water conservation, is reliable and accurate water measurement. The term "water measurement" as used in this manual refers to the measurement of flow (unit volume per unit time). Major advances in measurement technology along with a continued demand for the *Water Measurement Manual* are responsible for initiating this revision.

The first edition of the *Water Measurement Manual* (1953) had a distribution of 11,000 copies and was compiled from the Bureau of Reclamation (Reclamation) publication *Manual for Measurement of Irrigation Water* (1946). This previous manual had five earlier editions beginning in 1913 and extending to 1940. The continual demand for the *Water Measurement Manual* and the need for updating resulted in the second edition (1967). From 1967 to 1984, two revised reprints plus five reprints of the second edition were published. The demand and need for the second edition has continued because of conservation pressure and increased user competition for water; therefore, this third edition was prepared to supplement and update information contained in the second edition.

Modern trends of technical practice, along with the developments in personal computers, have resulted in increased emphasis on using custom-fitted, long-throated measurement structures that can be designed to measure flow and are simpler to fabricate. Consequently, fewer short-form flumes are being considered for new installations. Thus, information on Parshall flumes has been reduced and incorporated in the more general "Flumes" chapter, which recommends long-throated flumes for new installation in preference to Parshall flumes.

The main Parshall flume information retained in this edition relates to maintenance and operation needs of existing flumes, including flume dimensions, free flow measurement, submerged flow measurement, and head losses. The sections on size selection and setting crest elevation for Parshall flumes have been deleted or reduced in this edition. Where Parshall flumes may be desired or required by State law, examples in the previous editions of the manual can be referred to for size selection and setting the crest elevation.

New chapters and sections were added to make the third edition more current technologically and more useful to other government organizations. The new chapters added are:

- Basic Concepts Related to Flowing Water and Measurement
- Selection of Water Measuring Devices
- Measurement Accuracy
- Inspection of Water Measurement Systems
- Acoustic Flow Measurement
- Discharge Measurement Using Tracers

Russ Dodge was the primary author/editor for the revisions in this third edition. Reclamation especially appreciates the efforts of John Replogle and Albert Clemmens (from the U.S. Water Conservation Laboratory) of the Agricultural Research Service for writing major portions of chapters or separate sections relating to selection of devices, long-throated flumes, overshot weirs, and other devices, as well as for reviewing revisions of the entire manual.

Reclamation is also indebted to the U.S. Natural Resources Conservation Service, formerly the Soil Conservation Service, for contribution of material and reviews by Leland Hardy and Thomas Spofford. In addition to personnel from outside organizations, several Reclamation personnel contributed to revisions of new sections and chapters. Warren Frizell revised the chapter on measuring and recording water stage or head and conducted a peer review of the manual. Tracy Vermeyen wrote the chapter on acoustic flow measurements. Brent Mefford wrote much of the chapter on selection of water measurement devices. Dave Rogers wrote the section on radial gate flow measurements and the use of the RADGAT computer program. Tony Wahl compiled the tables in appendix A. Cliff Pugh coordinated the assembly, reviews, and publication. Jerry Fitzwater assembled and modified many of the drawings and figures. Tom Hovland was the primary technical editor in charge of publication editing and organization, and Teri Manross did the desktop publishing and copy editing. Jim Higgs created the online version of the manual, which is available at www.usbr.gov/pmts/hydraulics_lab/pubs/wmm/

Certain trade names appear in the manual. Mention of such names should not be construed as an endorsement or recommendation of a product by the Bureau of Reclamation, Agricultural Research Service, or Natural Resource Conservation Service.

CHAPTER 1 - INTRODUCTION

1. Need

Public concepts of how to share and manage the finite supplies of water are changing. Increasing competition exists between power, irrigation, municipal, industrial, recreation, aesthetic, and fish and wildlife uses. Within the United States, critical examinations of water use will be based on consumption, perceived waste, population density, and impact on ecological systems and endangered species. Water districts will need to seek ways to extend the use of their shares of water by the best available technologies. Best management measures and practices without exception depend upon conservation of water. The key to conservation is good water measurement practices.

As district needs for water increase, plans will be formulated to extend the use of water. Rather than finding and developing new sources, water often can be less expensively provided by conservation and equitable distribution of existing water supplies. Every cubic foot of water recovered as a result of improving water measurement produces more revenue than the same amount obtained from a new source. Better measurement procedures extend the use of water because poor operation and deterioration usually result in the delivery of excess water to users or lose it through waste. Beyond the district or supply delivery point, attention to measurement, management, and maintenance will also extend the farmer's water use and help prevent reduced yields and other crop damage caused by over-watering.

2. Benefits of Better Water Measurement

Besides proper billing for water usage, many benefits are derived by upgrading water measurement programs and systems. Although some of the benefits are intangible, they should be considered during system design or when planning a water measurement upgrade. Good water management requires accurate water measurement. Some benefits of water measurement are:

- Accurate accounting and good records help allocate equitable shares of water between competitive uses both on and off the farm.
- Good water measurement practices facilitate accurate and equitable distribution of water within district or farm, resulting in fewer problems and easier operation.
- Accurate water measurement provides the on-farm irrigation decision-maker with the information needed to achieve the best use of the irrigation water applied while typically minimizing negative environmental impacts.
- Installing canal flow measuring structures reduces the need for time-consuming current metering. Without these structures, current metering is frequently needed after making changes of delivery and to make seasonal corrections for changes of boundary resistance caused by weed growths or changes of sectional shape by bank slumping and sediment deposits.
- Instituting accurate and convenient water measurement methods improves the evaluation of seepage losses in unlined channels. Thus, better determinations of the cost benefits of proposed canal and ditch improvements are possible.
- Permanent water measurement devices can also form the basis for future improvements, such as remote flow monitoring and canal operation automation.

- Good water measurement and management practice prevents excess runoff and deep percolation, which can damage crops, pollute ground water with chemicals and pesticides, and result in project farm drainage flows containing contaminants.
- Accounting for individual water use combined with pricing policies that penalize excessive use.

3. Scope

This revised manual has three principal purposes. The first is to provide water users and districts guidance in selecting, managing, inspecting, and maintaining their water measurement devices. The second is to describe the standard methods and devices commonly used to measure irrigation water. The third is to acquaint irrigation system operators with a variety of other established but less common methods and with new or special techniques.

4. Use of the Manual

The order of chapters, or even sections within chapters, will not match all reader preferences or needs. Readers are not expected to read this manual from beginning to end. Individual readers have their own needs and can find required subjects and sections in the index and table of contents. Also, this manual does not attempt to fully cover advanced water measurement technology or theory. Nor is the manual meant to be a substitute for codes or standards such as International Organization for Standards (ISO) (1975) (1983) (1991) or American Society of Mechanical Engineers (ASME) (1992). These or other standards may be deemed necessary by regulation or management decision. When advance application approaches are needed, the reader should go to references at the end of each chapter. Good office references to have on hand are Bos (1989), which thoroughly covers water measurement devices; Bos et al. (1991) on flumes; and Clemmens et al. (1993), which provides software and excellent discussions of long-throated flumes and broad-crested weir computer design and calibration. The U.S. Government (1980) compiled a handbook containing information and references concerning most kinds of devices and techniques for open and closed channel flow. This publication also contains information concerning developing gaging stations with both permanent and shifting controls, both manmade and natural. The American Society of Mechanical Engineers (1971) and International Organization for Standards (ISO) (1991) provide considerable information on venturi meters and orifices in pipelines and give approach length requirements for various valve and bend combinations upstream from these meters. The Agricultural Research Service (ARS) *Field Manual* (Brakensiek et al., 1979) has information on H-flumes, triangular short-crested weirs, current metering, and other devices and methods used in agricultural hydrology.

5. Bibliography

American Society of Mechanical Engineers, "Fluid Meters, Their Theory and Application," H.S. Bean, ed., Research Committee on Fluid Meters, sixth edition revised, New York, 1983.

American Society of Mechanical Engineers, "Performance Test Codes-Hydraulic Turbines and Turbine Mode of Pump/Turbines," revision, Performance Test Code Committee No. 18, New York, 1992.

Bos, M.G. (ed.), *Discharge Measurement Structures*, 3rd edition, International Institute for Land Reclamation and Improvement, Publication 20, Wageningen, The Netherlands, 1989.

Bos, M.G., J.A. Replogle, and A.J. Clemmens, 1991, *Flow Measuring Flumes for Open Channel Systems*, John Wiley & Sons, 1984, and American Society of Agricultural Engineers, New York, 1991.

Brakensiek, D.L., H.B. Osborn, and W.R. Rawls (coordinators/editors), *Field Manual for Research in Agricultural Hydrology*, Agricultural Handbook 224, U.S. Department of Agriculture, U.S. Government Printing Office, Washington, DC, 1979.

Clemmens, A.J., M.G. Bos, and J.A. Replogle, "FLUME: Design and Calibration of Long-Throated Measuring Flumes," version 3.0, International Institute for Land Reclamation and Improvement, Publication 54 (with software), The Netherlands, 1993.

International Organization for Standardization, "Liquid Flow Measurement in Open Channels - Using Weirs and Flumes," ISO 1438, Geneva, Switzerland, 1975.

International Organization for Standardization, "Measurement of Liquid Flow in Open Channels," Handbook No. 15, Geneva, Switzerland, 1983.

International Organization for Standardization, "Measurement of Flow by Means of Pressure Differential Devices," ISO 5167-1, Geneva, Switzerland, 1991.

U.S. Geological Survey, *National Handbook of Recommended Methods of Water-Data Acquisition*, prepared cooperatively by U.S. Government agencies, Government Printing Office, Washington, DC, 1980.

CHAPTER 2 - BASIC CONCEPTS RELATED TO FLOWING WATER AND MEASUREMENT

1. Introduction

Experiences with the Bureau of Reclamation's Water Management Workshops, held each year in Denver, Colorado, have indicated a need to explain fundamental concepts of flowing water and its measurement. The workshops have also demonstrated the need to present concepts in simple terms using step-by-step development (Schuster, 1970). Because of more recent water measurement developments and the new chapters and sections added to this edition, this chapter has expanded the previous edition's appendix material into a more complete form. Thus, many more equations are included to maintain step-by-step development of the new material. Readers who have difficulties with algebra or the technical writing level should skim the text to provide exposure to concepts and terminology related to water measurement. More experienced water providers and users can use this chapter as a quick review of hydraulic principles related to water measurement.

Eventually, operators may wish to further investigate and seek more advanced references in hydraulics and fluid mechanics. Streeter (1951) has a chapter on flow measurement that covers tube-type flow meters. Bean (1971) has full information on fluid meter theory and provides detailed material for determining coefficients for tube-type meters. King and Brater (1963) have a thorough discussion of general critical depth relations and detailed relationships for most common hydraulic flow section shapes. Bos (1989) covers the entire field of open channel water measurement devices.

2. Kinds of Flow

Flow is classified into open channel flow and closed conduit flow. Open channel flow conditions occur whenever the flowing stream has a free or unconstrained surface that is open to the atmosphere. Flows in canals or in vented pipelines which are not flowing full are typical examples. The presence of the free water surface prevents transmission of pressure from one end of the conveyance channel to another as in fully flowing pipelines. Thus, in open channels, the only force that can cause flow is the force of gravity on the fluid. As a result, with steady uniform flow under free discharge conditions, a progressive fall or decrease in the water surface elevation always occurs as the flow moves downstream.

In hydraulics, a pipe is any closed conduit that carries water under pressure. The filled conduit may be square, rectangular, or any other shape, but is usually round. If flow is occurring in a conduit but does not completely fill it, the flow is not considered pipe or closed conduit flow, but is classified as open channel flow.

Flow occurs in a pipeline when a pressure or head difference exists between ends. The rate or discharge that occurs depends mainly upon (1) the amount of pressure or head difference that exists from the inlet to the outlet; (2) the friction or resistance to flow caused by pipe length, pipe roughness, bends, restrictions, changes in conduit shape and size, and the nature of the fluid flowing; and (3) the cross-sectional area of the pipe.

3. Basic Principles of Water Measurement

Most devices measure flow indirectly. Flow measuring devices are commonly classified into those that sense or measure velocity and those that measure pressure or head. The head or velocity is measured, and then charts, tables, or equations are used to obtain the discharge. Some water measuring devices that use measurement of head, h , or pressure, p , to determine discharge, Q , are:

- (1) Weirs
- (2) Flumes
- (3) Orifices
- (4) Venturi meters
- (5) Runup measurement on a flat "weir stick"

Head, h , or depth commonly is used for the open channel devices such as flumes and weirs. Either pressure, p , or head, h , is used with tube-type flowmeters such as a venturi.

Pressure, p , is the force per unit area as shown on figure 2-1 that acts in every direction normal to containing or submerged object boundaries. If an open vertical tube is inserted through and flush with the wall of a pipe under pressure, water will rise to a height, h , until the weight, W , of water in the tube balances the pressure force, F_p , on the wall opening area, a , at the wall connection. These tubes are called piezometers. The volume of water in the piezometer tube is designated ha . The volume times the unit weight of water, γha , is the weight, W .

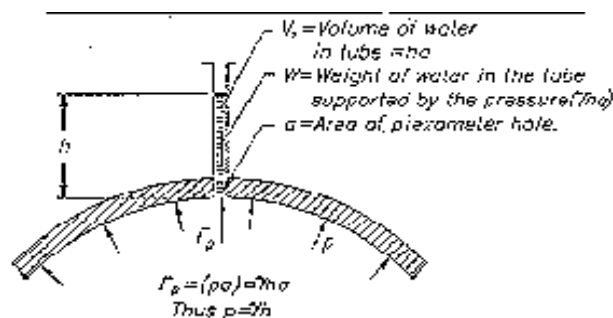


Figure 2-1. – Pressure definition

The pressure force, F_p , on the tap connection area is designated pa . The weight and pressure force are equal, and dividing both by the area, a , gives the unit pressure on the wall of the pipe in terms of head, h , written as:

$$p = \gamma h \quad (2-1)$$

or:

$$h = \frac{p}{\gamma} \quad (2-2)$$

Thus, head is pressure, p , divided by unit weight of water, γ , or 62.4 pounds per cubic foot (lb/ft^3). Pressure is often expressed in **psi** or pounds per square inch (lb/in^2), which may be converted to feet of water by multiplying the (lb/in^2) value by 2.31. For example, 30 lb/in^2 is produced by 69.3 feet of water. When the head principle is used, the discharge, Q , is computed from an equation such as the one used for a sharp-crested rectangular weir of length, L :

$$Q = CLh^{3/2} \quad (2-3)$$

A coefficient, C , is included that accounts for simplifying assumptions and other deficiencies in deriving the equation. The coefficient can vary widely in nonstandard installations, but is well defined for standard installations or is constant over a specified range of discharge.

The flow cross-sectional area, A , does not appear directly in the equation, but an area can be extracted by rewriting this equation:

$$Q = CLhh^{1/2} \quad (2-4)$$

in which:

$$A = Lh \quad (2-5)$$

In this form, C also contains a hidden square root of $2g$, which, when multiplied by $(h)^{1/2}$, is the theoretical velocity. This velocity does not need to be directly measured or sensed. Because the weir equation computes velocity from a measuring head, a weir is classified as a head measuring device.

Some devices that actually sample or sense velocities, v , are:

- (1) Float and stopwatch
- (2) Current and propeller meters
- (3) Vane deflection meters

These devices generally do not measure the average velocity, V , for an entire flow cross section. Thus, the relationship between sampled velocities, v , and the mean velocity, V , must be known as well as the flow section area, A , to which the mean velocity applies. Then, the discharge, Q , sometimes called the flow rate, is the product, AV .

Discharge or rate of flow has units of volume divided by unit time. Thus, discharge can be accurately determined by measuring the time, t , to fill a known volume, V_o :

$$Q = \frac{V_o}{t} \quad (2-6)$$

Water measurement devices can be calibrated using very accurate volumetric tanks and clocks. More commonly, weight of water in the tanks is used by converting the weight of water per unit volume. The weight of water per cubic foot, called unit weight or specific weight, γ , is 62.4 lb/ft³ at standard atmospheric conditions.

4. Discharge-Area-Velocity Relationships

Flow rate or discharge, Q , is the volume of water in cubic feet passing a flow section per unit time, usually measured in cubic feet per second (ft³/s). The distance, d_v , in feet that water will travel at a given velocity in a pipe of constant diameter is velocity, V , in feet per second (ft/s) multiplied by time, t , in seconds, or:

$$d_v = Vt \quad (2-7)$$

The volume, V_o , in cubic feet passing from the upstream to the downstream ends of this distance is the distance, d_v , in feet times area, A , in square feet of the flow section. Thus:

$$V_o = d_v A = AVt \quad (2-8)$$

To get the time rate of flow or discharge, Q , in cubic feet per second, divide the right and left sides of equation 2-8 by time, t , in seconds, resulting in:

$$Q = AV \quad (2-9)$$

Flow in open channels of rectangular cross section is often expressed in terms of unit discharge, q , in cubic feet per second per foot of width which is discharge, Q , in cubic feet per second divided by cross-sectional width, L_b , in feet or:

$$q = \frac{Q}{L_b} = \frac{VA}{L_b} = VD \quad (2-10)$$

The area, A , is $L_b D$, where D is the depth of flow. The continuity concept is an important extension of equation 2-9. On the basis that water is incompressible and none is lost from a flowing system, then as the cross-sectional area changes, the velocity must adjust itself such that the values of Q or VA are constant:

$$Q = A_1 V_1 = A_2 V_2 = \dots\dots\dots = A_n V_n \quad (2-11)$$

where the subscript denotes any number of arbitrarily selected positions along the flowing system. This principle, known as continuity, is especially useful in the analysis of tube flow measurement devices such as the venturi meter.

5. Flow Totalization

Water is sold and measured in terms of total volume consumed, say cubic feet, over some convenient time period, perhaps for billing each month. Many flowmeters have built in capability to sum or totalize volume continually. Thus, the volume consumed is obtained by taking the difference of two sequential monthly readings. To aid irrigation operation and management, most meters provide instantaneous rate of flow or discharge displayed in units such as cubic feet per second. These flow rates are used to set flow and predict the volume of water that will be consumed for intervals of time after flow setting.

6. Other Examples of Velocity Flow Measurement Devices

Measuring devices not previously mentioned are dilution in the concentration of tracers, such as salts and dyes; acoustic or magnetic meters; pitot tubes; rotameters, which are tapered tubes with suspended flow indicators; and many others that are not commonly used. In the dilution method, discharge is calculated by determining the quantity of water necessary to dilute a known quantity of concentrated chemical or dye solution. Chemical analysis or color comparison is used to determine the degree of dilution of the injected or mixed samples. In transit time acoustic meters, the velocity of sound pulses in the direction of flow is compared to the velocity of sound pulses opposite to the direction of flow to determine the mean velocity and, thus, discharge. With Doppler acoustic meters, sound pulses are reflected from moving particles within the water mass, similar to radar. In the magnetic meter, the flowing water acts like a moving electrical conductor passing through a magnetic field to produce a voltage that is proportional to discharge. Pitot tubes relate velocity head, $V^2/2g$, to discharge.

7. Velocity Head Concept

A dropped rock or other object will gain speed rapidly as it falls. Measurements show that an object dropping 1 foot (ft) will reach a velocity of 8.02 feet per second (ft/s). An object dropping 4 ft will reach a velocity of 16.04 ft/s. After an 8ft drop, the velocity attained is 22.70 ft/s. This gain in speed or acceleration is caused by the force of gravity, which is equal to 32.2 feet per second per second (ft/s^2). This acceleration caused by gravity is referred to as g .

If water is stored in a tank and a small opening is made in the tank wall 1 ft below the water surface, the water will spout from the opening with a velocity of 8.02 ft/s. This velocity has the same magnitude that a freely falling rock attains after falling 1 ft. Similarly, at openings 4 ft and 8 ft below the water surface, the velocity of the spouting water will be 16.04 and 22.68 ft/s, respectively. Thus, the velocity of water leaving an opening under a given head, h , is the same as the velocity that would be attained by a body falling that same distance.

The equation that shows how velocity changes with h and defines velocity head is:

$$V = \sqrt{2gh} \quad (2-12)$$

which may also be written in velocity head form as:

$$h = \frac{V^2}{2g} \quad (2-13)$$

8. Orifice Relationships

Equations 2-9 and 2-13 can be used to develop an equation for flow through an orifice, which is a sharp-edged hole in the side or bottom of a container of water (figure 2-2a). To find the velocity of flow in the orifice, use equation 2-13, then multiply by area to get AV , or discharge, Q , resulting in:

$$Q_t = A\sqrt{2gh} \quad (2-14)$$

The subscript t denotes theoretical discharge through an orifice. This equation assumes that the water is frictionless and is an ideal fluid. A correction must be made because water is not an ideal fluid. Most of the approaching flow has to curve toward the orifice opening. The water, after passing through the orifice, continues to contract or curve from the sharp orifice edge. If the orifice edges are sharp, the jet will appear as shown on figure 2-2. The maximum jet contraction occurs at a distance of one-half the orifice diameter ($d/2$) downstream from the sharp edge. The cross-sectional area of the jet is about six-tenths of the area of the orifice. Thus, equation 2-14 must be corrected using a contraction coefficient, C_c , to produce the actual discharge of water being delivered. Thus, the actual discharge equation is written as:

$$Q_a = C_c A\sqrt{2gh} \quad (2-15)$$

For a sharp-edged rectangular slot orifice where full contraction occurs, the contraction coefficient is about 0.61, and the equation becomes:

$$Q_a = 0.61A\sqrt{2gh} \quad (2-16)$$

A nonstandard installation will require further calibration tests to establish the proper contraction coefficient because the coefficient actually varies with the proximity to the orifice edge with respect to the approach and exit boundaries and approach velocity.

9. Thin Plate Weir Relationships

Most investigators derive the equation for sharp-crested rectangular weirs by mathematical integration of elemental orifice strips over the nappe (Bos, 1989). Each strip is considered an orifice with a different head on it.

The resulting rectangular weir equation for theoretical discharge is:

$$Q_t = \frac{2}{3} (2g)^{1/2} L_b h^{3/2} \quad (2-17)$$

A correction factor is needed to account for simplifications and assumptions. Thus, a discharge coefficient, C_d , is added to obtain actual discharge, expressed as:

$$Q_a = C_d \frac{2}{3} \sqrt{2g} L_b h^{3/2} \quad (2-18)$$

This relationship is the basic weir equation and can be modified to account for weir blade shape and approach velocity. However, C_d must be determined by analysis and calibration tests. For standard weirs, C_d is well defined or constant for measuring within specified head ranges.

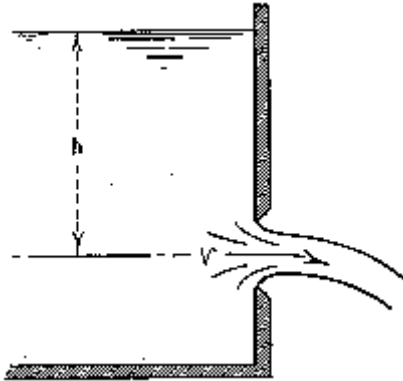


Figure 2-2a -- Orifice flow.

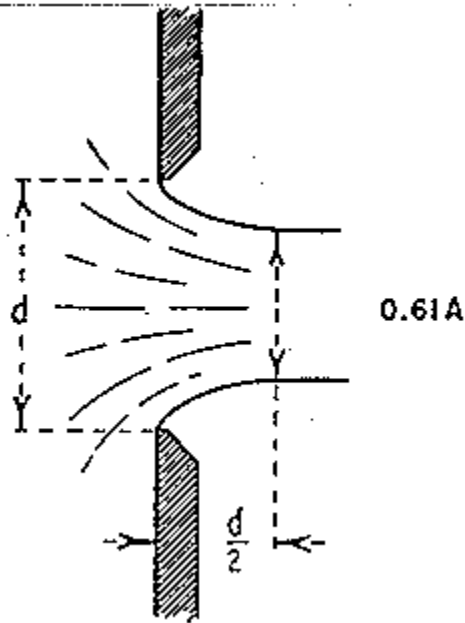


Figure 2-2b -- Contraction at an orifice.

10. Energy Balance Flow Relationships

Hydraulic problems concerning fluid flow are generally handled by accounting in terms of energy per pound of flowing water. Energy measured in this form has units of feet of water. The total amount of energy is that caused by motion, or velocity head, $V^2/2g$, which has units of feet, plus the potential energy head, Z , in feet, caused by elevation referenced to an arbitrary datum selected as reference zero elevation, plus the pressure energy head, h , in feet. The head, h , is depth of flow for the open channel flow case and p/γ defined by equation 2-2 for the closed conduit case. This summation of energy is shown for three cases on figure 2-3.

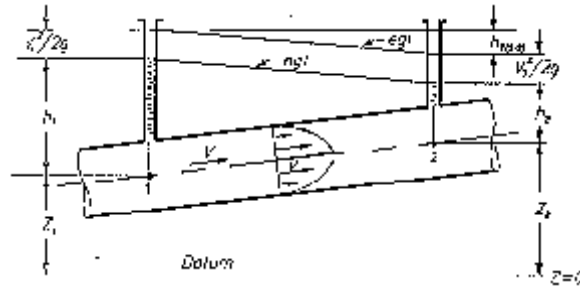


Figure 2-3a -- Energy balance in pipe flow.

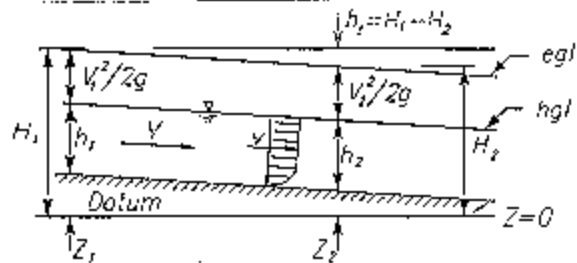


Figure 2-3b -- Energy balance in open channel flow.

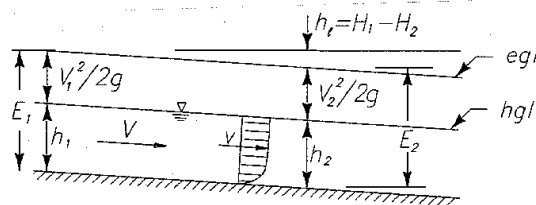


Figure 2-3c -- Specific energy balance.

Figures 2-3a and 2-3b show the total energy head, H_1 ; for example, at point 1, in a pipe and an open channel, which can be written as:

$$H_1 = h_1 + \frac{V_1^2}{2g} + Z_1 \quad (2-19)$$

At another downstream location, point 2:

$$H_2 = h_2 + \frac{V_2^2}{2g} + Z_2 \quad (2-20)$$

Energy has been lost because of friction between points 1 and 2, so the downstream point 2 has less energy than point 1. The energy balance is retained by adding a head loss, $h_{f(1-2)}$. The total energy balance is written as:

$$h_1 + \frac{V_1^2}{2g} + Z_1 = h_2 + \frac{V_2^2}{2g} + Z_2 + h_{f(1-2)} \quad (2-21)$$

The upper sloping line drawn between the total head elevations is the energy gradeline, *egl*. The next lower sloping solid line for both the pipe and open channel cases shown on figure 2-3 is the hydraulic grade line, *hgl*, which is also the water surface for open channel flow, or the height to which water would rise in piezometer taps for pipe flow.

A special energy form is commonly used in hydraulics in which the channel invert is selected as the reference Z elevation (figure 2-3c). Thus, Z drops out, and energy is the sum of depth, h , and velocity head only. Energy above the invert expressed this way is called specific energy, E . This simplified form of energy equation is written as:

$$\text{Specific energy} = E = \frac{V^2}{2g} + h \quad (2-22)$$

Equations 2-21 and 2-11 lead to several interesting conclusions. In a fairly short pipe that has little or insignificant friction loss, total energy at one point is essentially equal to the total energy at another point. If the size of the pipeline decreases from the first point to the second, the velocity of flow must increase from the first point to the second. This increase occurs because with steady flow, the quantity of flow passing any point in the completely filled pipeline remains the same. From the continuity equation (equation 2-11), when the flow area decreases, the flow velocity must increase.

The second interesting point is that when the velocity increases in the smaller section of the pipeline, the pressure head, h , decreases. At first, this decrease may seem strange, but equation 2-21 shows that when $V^2/2g$ increases, h must decrease proportionately because the total energy from one point to another in the system remains constant, neglecting friction loss. The fact that the pressure does decrease when the velocity in a given system increases is the basis for tube-type flow measuring devices.

In open channel flow where the flow accelerates, more of its supply of energy becomes velocity head, and depth must decrease. On the other hand, when the flow slows down, the depth must increase.

An example of accelerating flow with corresponding decreasing depth is found at the approach to weirs. The drop in the water surface is called drawdown. Another example occurs at the entrance to inverted siphons or conduits where the flow accelerates as it passes from the canal, through a

contracting transition, and into the siphon barrel. An example of decelerating flow with a rising water surface is found at the outlet of an inverted siphon, where the water loses velocity as it expands in a transition back into canal flow.

Flumes are excellent examples of measuring devices that take advantage of the fact that changes in depth occur with changes in velocity. When water enters a flume, it accelerates in a converging section. The acceleration of the flow causes the water surface to drop a significant amount. This change in depth is directly related to the rate of flow.

11. Hydraulic Mean Depth and Hydraulic Radius

Figure 2-4 shows an irregular flow cross section with different methods for defining depth of flow. In terms of frictional head losses, the perimeter is important. Hydraulic radius, R_h , is defined as the area of the flow section divided by the wetted perimeter, P_w , which is shown on figure 2-4 and is written as:

$$R_h = \frac{A}{P_w} \quad (2-23)$$

Thus, wetted perimeter times the hydraulic radius is equal to the area of irregular section flow as shown on figures 2-4a and 2-4c.

For use in Froude number and energy relationships in open channel flow hydraulics, mean depth, h_m , is defined as the depth which, when multiplied by the top water surface width, T , is equal to the irregular section area, A , shown on figures 2-4a and 2-4b, of the flow section and is commonly used for critical flow relationships. The equation for hydraulic mean depth, h_m , is:

$$h_m = \frac{A}{T} \quad (2-24)$$

In rectangular channels, hydraulic radius, R_h , does not equal depth, but approaches depth as the channel becomes very wide. However, the hydraulic mean depth, h_m , is the same as the depth of the rectangular flow section.

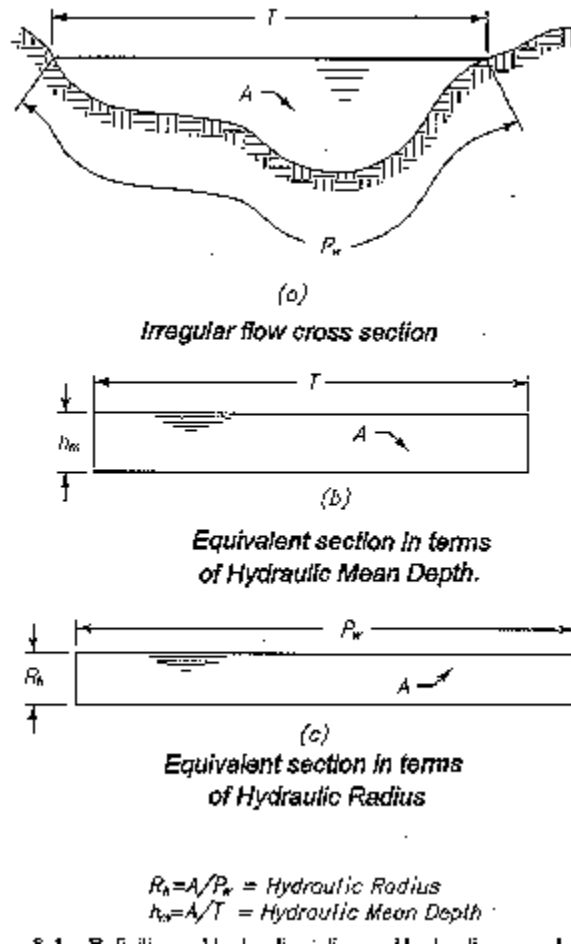


Figure 2-4 -- Definitions of hydraulic radius and hydraulic mean depth (area is the same for all three cases).

12. Froude Number, Critical Flow Relationships

In open channel hydraulics, the Froude number is a very important non-dimensional parameter. The Froude number, F , is the ratio of inertia force to gravity force, which simplifies to:

$$F = \frac{V}{\sqrt{gh_m}} \quad (2-25)$$

where the subscript m denotes hydraulic mean depth as defined previously in section 11 of this chapter.

For open channel modeling, the Froude number of a model is made equal to the Froude number of the actual full size device. The length ratio is set and the scale ratios for velocity and discharge are determined from the equality. However, the modeler must make sure that differences in friction loss between the model and the actual device are insignificant or accounted for in some way.

Open channel flow water measurement generally requires that the Froude number, F , of the approach flow be less than 0.5 to prevent wave action that would hinder or possibly prevent an accurate head reading.

When the Froude number is 1, the velocity is equal to the velocity of wave propagation, or celerity. When this condition is attained, downstream wave or pressure disturbances cannot travel upstream. A Froude number of 1 also defines a very special hydraulic condition. This flow condition is called critical and defines the critical mean depth and critical velocity relationship as:

$$F_c = \frac{V_c}{\sqrt{gh_{cm}}} \quad (2-26)$$

The subscript c denotes critical flow condition. The critical hydraulic mean depth, h_{cm} , is the depth at which total specific energy is minimum for a given discharge. Conversely, h_{cm} is the depth at which the discharge is maximum for a given total specific energy. When depth is greater than critical, the resulting velocity is considered streaming or tranquil and is called subcritical velocity. Conversely, when the depth is less than critical, the flow is rapid or shooting and is called super-critical velocity.

Water measurement flumes function best by forcing flow to pass through critical depth; then discharge can be measured using one head measurement station upstream. Also, for weirs and flumes, one unique head value exists for each discharge, simplifying calibration. This flow condition is called free flow. However, if the downstream depth submerges critical depth, then separate calibrations at many levels of submergence are required, and two head measurements are needed to measure flow.

Designing flumes for submerged flow will always decrease accuracy of flow measurement. Flumes and weirs can be submerged unintentionally by poor design, construction errors, structural settling, attempts to supply increased delivery needs by increasing downstream heads, accumulated sediment deposits, or weed growths.

Important critical flow relationships can be derived using equation 2-26 and rewriting in the form:

$$V_c = \sqrt{gh_{cm}} \quad (2-27)$$

Solving for head in equation 2-27 results in:

$$h_{cm} = \frac{V_c^2}{g} \quad (2-28)$$

Dividing both sides of this equation by 2 gives critical velocity head in terms of critical mean depth written as:

$$\frac{V_c^2}{2g} = \frac{h_{cm}}{2} \quad (2-29)$$

The total energy head with Z equal to zero for critical flow using equation 2-19 is:

$$H_c = h_c + \frac{V_c^2}{2g} \quad (2-30)$$

Squaring both sides of equation 2-27 and replacing velocity with Q/A and h_{cm} with A/T according to equation 2-24 and rearranging results in:

$$\frac{Q_c^2}{g} = \frac{A_c^3}{T_c} \quad (2-31)$$

This equation and the specific energy equation 2-22 are the basic critical flow relationships for any channel shape.

13. Discharge Equation for Broad-Crested Rectangular Weirs

The discharge equation for the rectangular broad-crested weir will now be derived similar to Bos (1989). The width, L_b , of a rectangular flow section is the same as T , the top water surface width. Also, h_c is the same as h_{cm} , and using equation 2-29 for velocity head, equation 2-30 can be rewritten as:

$$H_c = h_c + \frac{h_c}{2} \quad (2-32)$$

or:

$$H_c = \frac{3}{2} h_c \quad (2-33)$$

Conversely:

$$h_c = \frac{2}{3} H_c \quad (2-34)$$

Multiplying both sides of equation 2-27 by the area, A_c , of the flow section, which is $L_b h_c$, results in discharge expressed as:

$$Q = L_b h_c \sqrt{g h_c} = L_b \sqrt{g h_c}^{3/2} \quad (2-35)$$

To get unit discharge, q , this equation is divided by the width of flow, L_b , resulting in:

$$q = \frac{Q}{L_b} = \sqrt{gh_c}^{3/2} \quad (2-36)$$

Solving for h_c :

$$h_c = \sqrt[3]{\frac{q^2}{g}} \quad (2-37)$$

Using equation 2-34 to replace h_c with H_c in equation 2-35 results in theoretical discharge, Q_t :

$$Q_t = L_b \sqrt{g} \left(\frac{2}{3} H_c\right)^{3/2} \quad (2-38)$$

Discharges in equations 2-35 through 2-38 are usually considered actual, assuming uniform velocity throughout the critical depth cross section and assuming that no correction of velocity distribution is needed.

Because specific energy is constant in a fairly short measuring structure with insignificant friction losses, specific energy, H_c , at the critical location can be replaced with specific energy, H_1 , at a head measuring station a short distance upstream. However, some friction loss, possible flow curvature, and non-uniform velocity distribution occur. Thus, a coefficient of C_d must be added to correct for these effects, resulting in an expression for actual discharge:

$$Q_a = C_d L_b \frac{2}{3} \sqrt{\frac{2}{3}} g H_1^{3/2} \quad (2-39)$$

For measurement convenience, the total head, H_1 , is replaced with the depth, h_1 . To correct for neglecting the velocity head at the measuring station, a velocity coefficient, C_v , must be added, resulting in:

$$Q_a = C_d C_v L_b \frac{2}{3} \sqrt{\frac{2}{3}} g h_1^{3/2} \quad (2-40)$$

This equation applies to both long-throated flumes or broad-crested weirs and can be modified for any shape by analyses using the energy balance with equation 2-31.

These equations differ only in numerical constants that are derived from assumptions and selection of basic relationships used in their derivation. However, experimental determination of the coefficient values for C and C_v would compensate, making each equation produce the same discharge for the same measuring head. Either equation could be used.

The examples given above show that traditional discharge equations are often a mixture of rational analysis and experimental coefficient evaluation.

However, recent development of computer modeling of long-throated flumes (Clemmens et al. [1991]) precludes the need for experimental determination of coefficients. These long-throated flumes are covered in chapter 8.

14. Application of Energy Principle to Tube-Type Flowmeters

The energy equation can be used to derive the venturi meter (figure 2-5) equation by assuming that the centerline of the meter is horizontal ($Z_1 = Z_2$); and due to its short length, there is no head loss, $h_f = 0$. Although these assumptions were made to simplify the derivation, the final results will be identical for any orientation of the venturi meter.

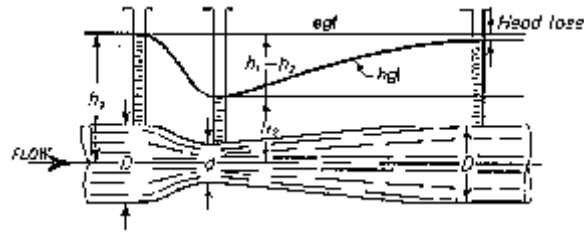


Figure 2-5 -- Venturi meter.

Thus:

$$h_1 + \frac{V_1^2}{2g} = h_2 + \frac{V_2^2}{2g} \quad (2-41)$$

By the continuity equation for the approach and throat sections:

$$V_1 A_1 = V_2 A_2 \quad (2-42)$$

Either V_1 or V_2 can be solved for in terms of the other; for example:

$$V_2 = V_1 \left(\frac{A_1}{A_2} \right) \quad (2-43)$$

Substituting this result into the energy equation results in:

$$h_1 + \frac{V_1^2}{2g} = h_2 + \frac{V_1^2}{2g} \left(\frac{A_1}{A_2} \right)^2 \quad (2-44)$$

Solving for the head difference gives:

$$h_1 - h_2 = \frac{V_1^2}{2g} \left(\frac{A_1}{A_2} \right)^2 - \frac{V_1^2}{2g} = \frac{V_1^2}{2g} \left[\left(\frac{A_1}{A_2} \right)^2 - 1 \right] \quad (2-45)$$

Solving for V_1^2 :

$$V_1^2 = \frac{(h_1 - h_2)2g}{\left(\frac{A_1}{A_2}\right)^2 - 1} \quad (2-46)$$

Taking the square root of both sides and multiplying both sides by A_1 results in the theoretical discharge equation:

$$Q_t = V_1 A_1 = A_1 \sqrt{\frac{2g(h_1 - h_2)}{\left(\frac{A_1}{A_2}\right)^2 - 1}} \quad (2-47)$$

To obtain actual discharge, a coefficient, C_d , added to compensate for velocity distribution and for minor losses not accounted for in the energy equation yields:

$$Q_a = C_d A_1 \sqrt{\frac{2g(h_1 - h_2)}{\left(\frac{A_1}{A_2}\right)^2 - 1}} \quad (2-48a)$$

Some investigators solve for discharge using throat area and velocity, resulting in:

$$Q_a = C_d A_2 \sqrt{\frac{2g(h_1 - h_2)}{1 - \left(\frac{A_2}{A_1}\right)^2}} \quad (2-48b)$$

However, equations 2-48a and 2-48b are identical and can be converted to:

$$Q_a = C_d A_1 A_2 \sqrt{\frac{2g(h_1 - h_2)}{A_1^2 - A_2^2}} \quad (2-49)$$

Equations 2-48b and 2-49 also apply to nozzles and orifices in pipes. On figure 2-5, the hydraulic grade line, hgl , represents the pressure that acts on the walls of the venturi meter. An appreciable drop will be noticed at the narrow throat, and a gradual pressure rise is seen as the flow leaves the throat and smoothly spreads and slows in the expanding portion of the meter.

Figure 2-6 shows the conditions that occur in a pipe orifice meter. As the flow approaches the orifice plate, the water near the pipe walls is slowed and stopped in the corners formed by the plate and the pipe walls. As a result, the pressure just ahead of the orifice at point B is a little greater than in the pipeline farther upstream at A. As the flow accelerates and passes through the orifice, the pressure drops and is lowest just downstream from the plate where the jet is smallest, and the velocity is highest at point C.

Farther down-stream, the flow begins to spread out and slow down, and a rise in pressure occurs at points D and E.

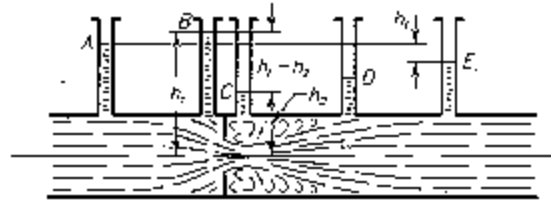


Figure 2-6 -- Pipe orifice meter.

In both venturi meters and orifice meters, the pressure difference between the inlet tap and the throat or minimum pressure tap is related to discharge tables or curves using the suitable coefficients with the proper equation. An example discharge curve is shown for an 8-inch (in) venturi meter on figure 2-7. Thus, the meters may serve as reliable flow measuring devices.

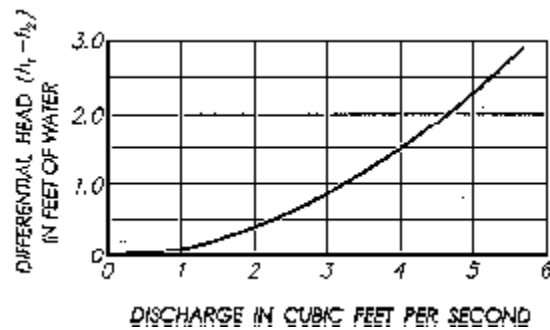


Figure 2-7 -- Typical calibration curve for an 8-in venturi meter.

15. Equation Coefficients

The previous examples show that coefficients are used in water measurement to correct for factors which are not fully accounted for using simplifying assumptions during derivations of equations. For the convenience of using a measured water head, h_1 , instead of the more complex total head, H_1 , C_v is used because velocity head is often ignored in equations.

Orifices require an area correction to account for jet contraction in an orifice, the flow is forced to curve around and spring from the sharp edge, forming a contracted jet or vena contracta. Thus, the contracted area of flow, A_c , should be used in hydraulic relationships. Thus, the area, A_o , of the orifice must be corrected by a coefficient of contraction defined as:

$$C_c = \frac{A_c}{A_o} \quad (2-50)$$

Properly designed venturi meters and nozzles have no contraction, which makes C_c unity because of the smooth transitions that allow the water to flow parallel to the meter boundary surfaces. Ultimately, the actual discharge must be measured experimentally by calibration tests, and the theoretical discharge must be corrected.

A common misconception is that coefficients are constant. They may indeed be constant for a range of discharge, which is the case for many standard measuring devices. Complying with structural and operational limits for standard devices will prevent measurement error caused by using coefficients outside of the proper ranges. Some water measuring devices cover wider ranges using variable coefficients of discharge by means of plots and tables of values with respect to head and geometry parameters.

Coefficients also vary with measuring station head or pressure tap location. Therefore, users should make sure that the coefficients used match pressure or head measurement locations. Water measurement equations generally require use of some to all of these coefficients to produce accurate results.

Often, composite numerical coefficients are given that are product combinations of area or a dimension factored from the area, acceleration of gravity, integration constants, and the correction coefficients. However, geometry dimensions and physical constants, such as acceleration of gravity, are better kept separate from the nondimensional coefficients that account for the difference between theoretical and actual conditions. Otherwise, converting equations from English to metric units is more difficult.

Equation 2-49 also applies to orifices and nozzles. The coefficient of discharge for venturi meters ranges from 0.9 to about unity in the turbulent flow range and varies with the diameter ratio of throat to pipe. The coefficient of discharge for orifices in pipes varies from 0.60 to 0.80 and varies with the diameter ratio. For flow nozzles in pipelines, the coefficient varies from 0.96 to 1.2 for turbulent flow and varies with the diameter ratio. ASME (1983) and ISO (1991) have a detailed treatment of pipeline meter theory, coefficients, and instruction in their use.

16. Normal Flow Equations and Friction Head Loss

Many measuring devices, such as flumes, weirs, and submerged orifices, are sensitive to exit flow conditions. Flumes and weirs can be drowned out by too much downstream submergence depth, and submerged orifices can have too little downstream water above the top orifice edge. Therefore, reliable knowledge of exit depth conditions is needed to properly set the elevation of crests and orifices so as to not compromise accuracy. Inaccurate assessment of downstream depth has even made some measuring device installations useless. Good operation and flow depth forecasts are needed to ensure the design effectiveness of new irrigation measurement systems. Designing for the insertion of a new device into an existing system provides a good opportunity to obtain actual field measurements for investigating possible submergence problems.

The use of actual discharge water surface measurements is recommended. In the absence of actual measurements, normal flow equations are often used to predict flow depths.

Normal flow occurs when the water surface slope, S_{ws} , is the same as the invert or bottom slope, S_o . When normal flow is approached, the velocity equations of Chezy, Manning, and Darcy-Weisbach are used to compute depth of flow. However, these equations are in terms of hydraulic radius, R_h , and depth must be determined on the basis of the definition of R_h , which is the cross-sectional area, A , divided by its wetted perimeter, P_w .

Chezy developed the earliest velocity equation, expressed as:

$$V = C\sqrt{R_h S} \quad (2-51)$$

Manning's equation is more frequently used and is expressed as:

$$V = \frac{1.49}{n} R_h^{2/3} S^{1/2} \quad (2-52)$$

The Darcy-Weisbach equation is a more rigorous relationship, written as:

$$V = \sqrt{\frac{8gR_h S}{f}} \quad (2-53)$$

The coefficients C , n , and f are friction factors. The Darcy-Weisbach friction factor, f , is nondimensional and is a function of Reynolds number, $4R_h V/L$, and relative roughness, $k/4R_h$, in which L is kinematic viscosity, and k is a linear measure of boundary roughness size. The Reynolds number accounts for variation of viscosity. This function is given in the form of plots in any fluid mechanics textbook; for example, Streeter (1951), Rouse (1950), and Chow (1959). These plots are generally in terms of pipe diameter, D , which should be replaced with $4R_h$ for open channel flow. Values of k have been determined empirically and are constant for a given flow boundary material as long as the roughness can be considered a homogenous texture rather than large roughness elements relative to the depth.

Solving equations 2-51, 2-52, and 2-53 for $V/(R_h S)^{1/2}$ results in a combined flow equation and relationship between the three friction factors, C , n , and f , written as:

$$\frac{1.49R_h^{1/6}}{n} = \sqrt{\frac{8g}{f}} = C = \frac{V}{\sqrt{R_h S}} \quad (2-54)$$

Solving for velocity using equation 2-54 and multiplying by area produces a discharge equation and can be used in the slope area method of determining discharge as discussed in chapter 13.

All three of these friction factors have been determined empirically, computed from measurement of equation variables. The Chezy factor, C , varies with hydraulic radius, slope, and physical boundary roughness. The Chezy factor varies from 22 to 220.

Manning's friction factor, n , varies from 0.02 for fine earth lined channels to 0.035 for gravel. If the channel beds are strewn with rocks or are 1/3 full of vegetation, the n value can be as much as 0.06. The n values for concrete vary from 0.011 to 0.016 as finish gets rougher. Values of k can be found in hydraulic and fluid mechanics textbooks such as Streeter (1951), Rouse (1950), and Chow (1959). The value of k for concrete varies from 0.01 to 0.0001 ft depending on condition and quality of finishing.

Because Chezy and Manning equations and their friction factors have been determined for ordinary channel flows, they do not accurately apply to shallow flow, nor can these two equations be corrected for temperature viscosity effects. Values of k are constant for given material surfaces for $k/4R_h$ equal or less than 1/10 and when $4R_hV/v$ is greater than 200,000.

Flow depths downstream are more likely the result of intentional structural restriction or water delivery head requirements downstream. Therefore, in designing and setting the elevation of flumes and weirs, the flow conditions just downstream need to be carefully assessed or specified in terms of required downstream operations and limits of measuring devices. More advanced hydraulic analyses are needed where normal flow is not established. For gradually varied flow, the friction equations can be used as trial and error computations applied to average end section hydraulic variables for relatively short reach lengths. The design and setting of crest elevations in an existing system permit the establishment of operation needs and downstream depths by actual field measurement.

17. Approach Flow Conditions

Water measurement devices are generally calibrated with certain approach flow conditions. The same approach conditions must be attained in field applications of measuring devices.

Poor flow conditions in the area just upstream from the measuring device can cause large discharge indication errors. In general, the approaching flow should be subcritical. The flow should be fully developed, mild in slope, and free of curves, projections, and waves. Pipeline meters commonly require 10 diameters of straight pipe approach. Fittings and combinations of fittings, such as valves and bends, located upstream from a flowmeter can increase the number of required approach diameters. *Fluid Meters* (American Society of Mechanical Engineers, 1983) and International Organization for Standardization (1991) give requirements for many pipeline configurations. By analogy and using a minimum of 10 pipe diameters of straight approach, open channel flow would require 40 hydraulic radii of straight, unobstructed, unaltered approach.

A typical example approach criteria as specified by Bos (1989) follows:

- If the control width is greater than 50 percent of the approach channel width, then 10 average approach flow widths of straight, unobstructed approach are required.
- If the control width is less than 50 percent of the approach width, then 20 control widths of straight, unobstructed approach are required.
- If upstream flow is below critical depth, a jump should be forced to occur. In this case, 30 measuring heads of straight, unobstructed approach after the jump should be provided.
- If baffles are used to correct and smooth out approach flow, then 10 measuring heads ($10h_1$) should be placed between the baffles and the measuring station.

Approach flow conditions should be continually checked for deviation from these conditions as described in chapter 8 of this manual.

18. Bibliography

American Society of Mechanical Engineers, "Fluid Meters, Their Theory and Application," H.S. Bean, ed., Research Committee on Fluid Meters, sixth edition revised, New York, 1983.

Bos, M.G. (ed.), *Discharge Measurement Structures*, 3rd edition, International Institute for Land Reclamation and Improvement, Publication 20, Wageningen, The Netherlands, 1989.

Chow, V.T., *Open-Channel Hydraulics*, McGraw-Hill Book Company, Inc., 1959.

Clemmens, A.J., M.G. Bos, and J.A. Replogle, "FLUME: Design and Calibration of Long-Throated Measuring Flumes," version 3.0, International Institute for Land Reclamation and Improvement, Publication 54 (with software), The Netherlands, 1993.

International Organization for Standardization, "Measurement of Flow by Means of Pressure Differential Devices," ISO 5167-1, Geneva, Switzerland, 1991.

King, H.W., and E.F. Brater, *Handbook of Hydraulics*, fifth edition, McGraw-Hill Book Company, Inc., New York, 1963.

Rouse, H., *Elementary Mechanics of Fluids*, John Wiley and Sons, Inc., New York, 1950.

Schuster, J.S., "Water Measurement Procedures-Irrigation Operators Workshop," REC-OCE-70-38, U.S. Bureau of Reclamation Publication, 1970.

Streeter, V.L., *Fluid Mechanics*, McGraw-Hill Book Company, Inc., 1951.

CHAPTER 3 - MEASUREMENT ACCURACY

1. Introduction

Accurate application of water measuring devices generally depends upon standard designs or careful selection of devices, care of fabrication and installation, good calibration data and analyses, and proper user operation with sufficiently frequent inspection and maintenance procedures. In operations, accuracy requires continual verification that the measuring system, including the operators, is functioning properly. Thus, good training and supervision is required to attain measurements within prescribed accuracy bounds. **Accuracy** is the degree of conformance of a measurement to a standard or true value. The standards are set by users, providers, governments, or compacts between these entities. Accuracy is usually stated in terms of deviation of discharge discussed subsequently. All parts of a measuring system, including the user, need to be considered in accessing the system's total accuracy.

A measurement system usually consists of a **primary element**, which is that part of the system that creates what is sensed, and is measured by a **secondary element**. For example, weirs and flumes are primary elements. A staff gage is the secondary element.

Purchasers and users of water measurement devices generally depend upon standard designs and manufacturers to provide calibrations and assurances of accuracy. A few irrigation water users or providers have the facilities to check the condition and accuracy of flow measuring devices. These facilities have comparison flowmeters and/or volumetric tanks for checking their flowmeters. These test systems are used to check devices for compliance with specification and to determine maintenance needs. However, maintaining facilities such as these is not generally practical.

One purpose of this chapter is to define terms used by manufacturers and sales representatives related to measuring device specifications, calibration, and error analyses. Various disciplines and organizations do not fully agree on some of these definitions. Therefore, one should ask for clarification of these definitions when others use these terms. Another purpose is to provide example analyses which can help in managing the accuracy of irrigation water delivery.

2. Definitions of Terms Related to Accuracy

Precision is the ability to produce the same value within given accuracy bounds when successive readings of a specific quantity are measured. Precision represents the maximum departure of all readings from the mean value of the readings. Thus, a measurement cannot be more accurate than the inherent precision of the combined primary and secondary precision. **Error** is the deviation of a measurement, observation, or calculation from the truth. The deviation can be small and inherent in the structure and functioning of the system and be within the bounds or limits specified. Lack of care and mistakes during fabrication, installation, and use can often cause large errors well outside expected performance bounds.

Since the true value is seldom known, some investigators prefer to use the term **Uncertainty**. Uncertainty describes the possible error or range of error which may exist. Investigators often classify errors and uncertainties into spurious, systematic, and random types.

Spurious errors are commonly caused by accident, resulting in false data. Misreading and intermittent mechanical malfunction can cause discharge readings well outside of expected random statistical distribution about the mean. A hurried operator might incorrectly estimate discharge. Spurious errors can be minimized by good supervision, maintenance, inspection, and training. Experienced, well-trained operators are more likely to recognize readings that are significantly out of the expected range of deviation. Unexpected spiral flow and blockages of flow in the approach or in the device itself can cause spurious errors. Repeating measurements does not provide any information on spurious error unless repetitions occur before and after the introduction of the error. On a statistical basis, spurious errors confound evaluation of accuracy performance.

Systematic errors are errors that persist and cannot be considered entirely random. Systematic errors are caused by deviations from standard device dimensions. Systematic errors cannot be detected by repeated measurements. They usually cause persistent error on one side of the true value. For example, error in determining the crest elevation for setting staff or recorder chart gage zeros relative to actual elevation of a weir crest causes systematic error. The error for this case can be corrected when discovered by adjusting to accurate dimensional measurements. Worn, broken, and defective flowmeter parts, such as a permanently deformed, over-stretched spring, can cause systematic errors. This kind of systematic error is corrected by maintenance or replacement of parts or the entire meter. Fabrication error comes from dimensional deviation of fabrication or construction allowed because of limited ability to exactly reproduce important standard dimensions that govern pressure or heads in measuring devices. Allowable tolerances produce small systematic errors which should be specified.

Calibration equations can have systematic errors, depending on the quality of their derivation and selection of form. Equation errors are introduced by selection of equation forms that usually only approximate calibration data. These errors can be reduced by finding better equations or by using more than one equation to cover specific ranges of measurement. In some cases, tables and plotted curves are the only way to present calibration data.

Random errors are caused by such things as the estimating required between the smallest division on a head measurement device and water surface waves at a head measuring device. Loose linkages between parts of flowmeters provide room for random movement of parts relative to each other, causing subsequent random output errors. Repeating readings decreases average random error by a factor of the square root of the number of readings.

Total error of a measurement is the result of systematic and random errors caused by component parts and factors related to the entire system. Sometimes, error limits of all component factors are well known. In this case, total limits of simpler systems can be determined by computation (Bos et al., 1991).

In more complicated cases, different investigators may not agree on how to combine the limits. In this case, only a thorough calibration of the entire system as a unit will resolve the difference. In any case, it is better to do error analysis with data where entire system parts are operating simultaneously and compare discharge measurement against an adequate discharge comparison standard.

Calibration is the process used to check or adjust the output of a measuring device in convenient units of gradations. During calibration, manufacturers also determine robustness of equation forms and coefficients and collect sufficient data to statistically define accuracy performance limits. In the case of long-throated flumes and weirs, calibration can be done by computers using hydraulic theory. Users often do less rigorous calibration of devices in the field to check and help correct for problems of incorrect use and installation of devices or structural settlement. A calibration is no better than the comparison standards used during calibration.

Comparison standards for water measurement are systems or devices capable of measuring discharge to within limits at least equal to the desired limits for the device being calibrated. Outside of the functioning capability of the primary and secondary elements, the quality of the comparison standard governs the quality of calibration.

Discrepancy is simply the difference of two measurements of the same quantity. Even if measured in two different ways, discrepancy does not indicate error with any confidence unless the accuracy capability of one of the measurement techniques is fully known and can be considered a working standard or better. Statistical **deviation** is the difference or departure of a set of measured values from the arithmetic mean.

Standard Deviation Estimate is the measure of dispersion of a set of data in its distribution about the mean of the set. Arithmetically, it is the square root of the mean of the square of deviations, but sometimes it is called the root mean square deviation. In equation form, the estimate of standard deviation is:

$$S = \sqrt{\frac{\Sigma(X_{avg} - X_{Ind})^2}{(N - 1)}} \quad (3-1)$$

where:

S = the estimate of standard deviation

X_{Avg} = the mean of a set of values

X_{Ind} = each individual value from the set

N = the number of values in a set

Σ = summation

The variable X can be replaced with data related to water measurement such as discharge coefficients, measuring heads, and forms of differences of discharge.

The sample number, N , is used to calculate the mean of all the individual deviations, and $(N - 1)$ is used to calculate the estimate of standard deviation. This is done because when you know the mean of the set of N values and any subset of $(N - 1)$ values, the one excluded value can be calculated. Using $(N-1)$ in the calculation is important for a small number of readings.

For the sample size that is large enough, and if the mean of the individual deviations is close to zero and the maximum deviation is less than $\pm 3S$, the sample distribution can be considered normally distributed. With normal distribution, it is expected that any additional measured value would be within $\pm 3S$ with a 99.7 percent chance, $\pm 2S$ with a 95.4 percent chance, and $\pm S$ with a 68.3 percent chance.

Measurement device specifications often state accuracy capability as plus or minus some percentage of discharge, meaning without actually stating, $\pm 2S$, two times the standard deviation of discharge comparisons from a calibration. However, the user should expect an infrequent deviation of $\pm 3S$.

Error in water measurement is commonly expressed in percent of comparison standard discharge as follows:

$$E_{\%Q_{Cs}} = \frac{100(Q_{Ind} - Q_{Cs})}{Q_{Cs}} \quad (3-2)$$

where:

Q_{Ind} = indicated discharge from device output

Q_{Cs} = comparison standard discharge concurrently measured in a much more precise way

$E_{\%Q_{Cs}}$ = error in percent comparison standard discharge

Comparison standard discharge is sometimes called actual discharge, but it is an ideal value that can only be approached by using a much more precise and accurate method than the device being checked.

Water providers might encounter other terms used by instrument and electronic manufacturers. Some of these terms will be described. However, no universal agreement exists for the definition of these terms. Therefore, water providers and users should not hesitate to ask manufacturers' salespeople exactly what they mean or how they define terms used in their performance and accuracy claims. Cooper (1978) is one of the many good references on electronic instrumentation.

Error in **percent full scale**, commonly used in electronics and instrumentation specifications, is defined as:

$$E_{\%Q_{FS}} = \frac{100(Q_{Ind} - Q_{Cs})}{Q_{FS}} \quad (3-3)$$

where:

Q_{md} = indicated discharge

Q_{Cs} = comparison standard discharge concurrently measured

Q_{FS} = full scale or maximum discharge

$E_{\%Q_{FS}}$ = error in percent full-scale discharge

To simply state that a meter is "3 percent accurate" is incomplete. Inspection of equations 3-2 and 3-3 shows that a percentage error statement requires an accompanying definition of terms used in both the numerator and denominator of the equations.

For example, a flowmeter having a full scale of 10 cubic feet per second (ft^3/s) and a full scale accuracy of 1 percent would be accurate to $\pm 0.1 \text{ ft}^3/\text{s}$ for all discharges in the flowmeter measurement range. Some manufacturers state accuracy as 1 percent of measured value. In this case, the same example flowmeter would be accurate to within $\pm 0.1 \text{ ft}^3/\text{s}$ at full scale; and correspondingly, a reading of $5 \text{ ft}^3/\text{s}$ would be accurate to within $\pm 0.05 \text{ ft}^3/\text{s}$ for the same flowmeter at that measurement.

3. Capability Terms

The term **linearity** usually means the maximum deviation in tracking a linearly varying quantity, such as measuring head, and is generally expressed as percent of full scale. **Discrimination** is the number of decimals to which the measuring system can be read. **Repeatability** is the ability to reproduce the same reading for the same quantities. **Sensitivity** is the ratio of the change of measuring head to the corresponding change of discharge. **Range** is fully defined by the lowest and highest value that the device can measure without damage and comply with a specified accuracy. The upper and lower range bounds may be the result of mechanical limitations, such as friction at the lower end of the range and possible overdriving damage at the higher end of the range. Range can be designated in other ways: (1) as a simple difference between maximum discharge (Q_{max}) and minimum discharge (Q_{min}), (2) as the ratio (Q_{max}/Q_{min}), called **rangeability**, and (3) as a ratio expressed as $1:(Q_{min}/Q_{max})$. Neither the difference nor the ratios fully define range without knowledge of either the minimum or maximum discharge.

Additional terms are related more to dynamic variability and might be important when continuous records are needed or if the measurements are being sensed for automatic control of canals and irrigation.

Hysteresis is the maximum difference between measurement readings of a quantity established by the same mechanical set point when set from a value above and reset from a value below. Hysteresis can continually get worse as wear of parts increases friction or as linkage freedom increases. **Response** has several definitions in the instrumentation and measurement fields. For water measurement, one definition for response is the smallest change that can be sensed and displayed as a significant measurement. **Lag** is the time difference of an output reading when tracking a continuously changing quantity.

Rise time is often expressed in the form of the **time constant**, defined as the time for an output of the secondary element to achieve 63 percent of a step change of the input quantity of the primary element.

4. Comparison Standards

Water providers may want or be required to have well developed measurement programs that are highly managed and standardized. If so, irrigation managers may wish to consult International Organization for Standardization (1983), American Society for Testing Materials standards (1988), American Society of Mechanical Engineers Test Codes (1992), and the *National Handbook of Recommended Methods for Water Data Acquisition* (1980).

Research laboratories, organizations, and manufacturers that certify measurement devices may need to trace accuracy of measurement through the entire hierarchy of increasingly rigid standards.

The lowest standards in the entire hierarchy of physical comparison standards are called **working standards**, which are shop or field standards used to control quality of production and measurement. These standards might be gage blocks or rules used to assure proper dimensions of flumes during manufacture or devices carried by water providers and users to check the condition of water measurement devices and the quality of their output. Other possible working standards are weights, volume containers, and stop watches. More complicated devices are used, such as surveyor's levels, to check weir staff gage zeros. Dead weight testers and electronic standards are needed to check and maintain more sophisticated and complicated measuring devices, such as acoustic flowmeters and devices that use pressure cells to measure head.

For further measurement assurance and periodic checking, water users and organizations may keep secondary standards. **Secondary standards** are used to maintain integrity and performance of working standards. These secondary standards can be sent to government laboratories, one of which is the National Bureau of Standards in Washington, DC, to be periodically certified after calibration or comparison with very accurate replicas of primary standards. **Primary standards** are defined by international agreement and maintained at the International Bureau of Weights and Measurements, Paris, France.

Depending upon accuracy needs, each organization should trace their measurement performance up to and through the appropriate level of standards. For example, turbine acceptance testing combined with severe contractual performance penalties might require tracing to the primary standards level.

5. Examples of Calibration Approaches and Accuracy Calculations

The following examples show different approaches to calibration and demonstrate other simple calculations and analyses that can be done concerning accuracy. These calculations can be used to investigate how well a water provider or user is measuring flow. Also, some of the example analyses will help select secondary head measuring equipment and will help determine when maintenance or replacement is needed.

(a) Number of Significant Figures in Computations

Although accuracy is necessary in computing discharges from data gathered in the field, the computations should not be carried out to a greater number of significant figures than the quality of the data justifies. Doing so would imply an accuracy which does not exist and may give misleading results. For example, suppose it is desired to compute the discharge over a standard contracted rectangular weir using the formula:

$$Q = C(L-0.2h_1)h_1^{3/2} \quad (3-4)$$

where:

Q = the discharge in ft³/s

C = 3.33, a constant for the weir

L = the length of the weir in feet (ft)

h_1 = the observed head on the weir (ft)

If the length of the weir is 1.50 ft and the observed head is 0.41 ft, the significant equation output is 1.24 ft³/s.

As a rule, in any computation involving multiplication or division in which one or more of the numbers is the result of observation, the answer should contain the same number of significant figures as is contained in the observed quantity having the fewest significant figures. In applying this rule, it should be understood that the last significant figure in the answer is not necessarily correct, but represents merely the most probable value.

(b) Calibration of an Orifice

The calibration of a submerged rectangular orifice requires measuring head for a series of discharges, covering the full range of operation, with another more precise and accurate system sometimes called a standard control. Based on hydraulic principles, discharge varies as the square root of the head differential, and the equation for discharge through a submerged orifice can be written as:

$$Q = C_d A \sqrt{2g(\Delta h)} \quad (3-5)$$

where:

Q = discharge

g = acceleration caused by gravity

Δh = upstream head minus the head on the downstream side of the orifice

A = the area of the orifice

C_d = coefficient of discharge

Also, the coefficient of discharge, C_d , must be determined experimentally for any combination of orifice shape, measuring head locations, and the location of orifice relative to the flow boundaries. The coefficient has been found to be constant if the orifice perimeter is located away from the approach channel boundary at least a distance equal to twice the minimum orifice opening dimensions. Values of the discharge coefficient calculated by putting the measured calibration data into equation 3-5 may be constant within experimental error if the orifice geometry complies with all the requirements for standard orifices throughout the calibration range.

An example set of discharge data is shown in table 3-1. The theoretical hydraulic equation 3-5 was used to compute values of the coefficient of discharge, C_d . The mean of the values (0.61) is the most probable equation coefficient based on 15 readings. The deviation or spread of individual coefficient values from the mean value would be the measure of the uncertainty of the measuring system as used during the calibration. The deviation of coefficient values is an indication of how well the calibration was done. Therefore, accuracy statements should also include statements concerning the head reading technique capability and the accuracy of the standard device used to measure discharge. If several orifices of the same size were calibrated together, then the accuracy statements can be made concerning limits of fabrication and installation of the orifices.

The histogram of the same data as shown on figure 3-1 was developed by splitting the range of discharge values into five 0.005-ft³/s intervals. Then the data were tallied as they occurred in each interval. The plotted values of occurrence approach a symmetrical bell shape curve centered around the mean of 0.61, indicating that the data are random or normally distributed and that enough data were obtained to determine a meaningful average value for the discharge coefficient.

Table 3-1. An example of discharge data		
Discharge (ft ³ /s)	Head difference (ft)	Discharge coefficient
3.702	0.253	0.611
3.613	0.245	0.606
3.545	0.232	0.608
3.361	0.209	0.611
3.267	0.197	0.616
3.172	0.189	0.606
3.005	0.163	0.618
2.924	0.161	0.605
2.842	0.154	0.602
2.565	0.127	0.598
2.450	0.109	0.616
2.323	0.100	0.610
1.986	0.073	0.611
1.813	0.060	0.615
1.640	0.050	0.609
Standard deviation =		$\Sigma C_d = 9.142$ $C_{d\text{ Avg}} = 0.610$ $S = 0.006$

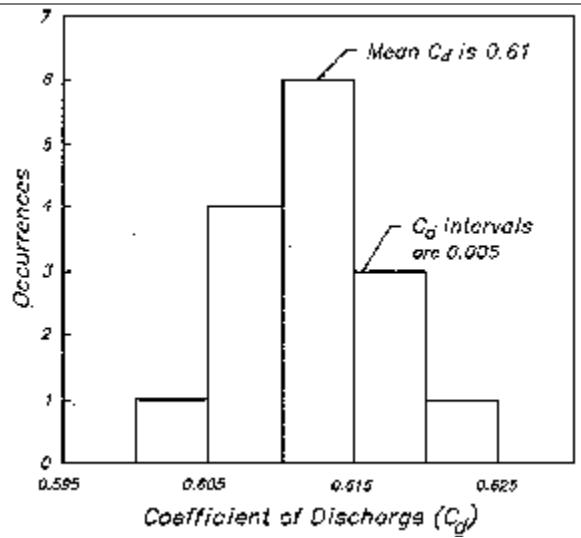


Figure 3-1 -- Histogram of discharge coefficients.

The measure of the spread of repeated measurements such as the discharge coefficient is the estimated standard deviation, which when using the form of equation 3-1 is written as:

$$S = \sqrt{\frac{\Sigma(C_d - C_{d \text{ Avg}})^2}{(N - 1)}} \quad (3-6)$$

where Σ denotes summation, and N is the number of C_d values. The value of S is the estimate of standard deviation, σ , which is approached more closely as the number of samples, N , becomes larger. Formal, small sample statistical methods can be used to evaluate confidence bounds around S based on sample size. After N has become large enough and normal distribution is verified, all previous and subsequent data are expected to fall within the bounds of $\pm S$, $\pm 2S$, and $\pm 3S$ for about 68.3, 95.4, and 99.7 percent confidence levels, respectively.

(c) Error Analysis of Calibration Equation

Often, structural compromise, in Parshall flumes for example, is such that hydraulic theory and analysis cannot determine the exponents or the coefficients. These devices must be calibrated by measuring head for a series of discharges well distributed over the flow range and measured with another, more accurate device. The data can be plotted as a best fit curve on graph paper. However, determination of equations for table generation would be preferable.

Parshall flumes and many other water measuring devices have close approximating equations of the form:

$$Q = Ch_1^n \quad (3-7)$$

If the data plot as a straight line on log-log graph paper, then equation 3-7 can be used as the calibration form, and a more rigorous statistical approach to calibration is possible. This equation can be linearized for regression analysis by taking the log of both sides, resulting in:

$$\log Q = n \log h_1 + \log C \quad (3-8)$$

Although a regression analysis can produce correlation coefficients greater than 0.99, with 1.0 being perfect, large deviations in discharge can exist. These deviations include error of estimating head between scale divisions for both the test and comparison standard devices, known errors of the comparison standard, and possible offset from linearity of the measuring device. For example, a laboratory calibration check of a 9-inch Parshall flume in a poor approach situation, using a venturi meter as the comparison standard, resulted in a correlation coefficient of 0.99924, an equation coefficient, C , of 3.041, and an exponent of 1.561 using 15 values of discharge versus measuring head pairs. For the properly set flume in tranquil flow, C is 3.07 and n is 1.56.

To overcome the defect of using correlation coefficients that are based on log units, the flume measuring capability should be investigated in terms of percent discharge deviations, ΔQ , or expressed as:

$$\Delta Q\% = \frac{100(Q_{Eq} - Q_{Cs})}{Q_{Cs}} \quad (3-9)$$

where:

$\Delta Q\%$ = percent deviation of discharge

Q_{Cs} = measured comparison standard discharge

Q_{Eq} = discharge computed using measured heads and the regression equation

Then, calculate the estimate of standard deviation, S , and substitute $\Delta Q\%$ for C_d in equation 3-6F from the previous example. For the Parshall flume example, S was about 3.0 percent. The maximum deviation for the example flume was about -10 percent, and the average deviation was about 0.08 percent discharge, which is a small bias from the expected zero. Because of this small bias combined with a maximum absolute deviation of about $3S$, the error was considered normally distributed, and the sample size, N , was considered adequate. Examples will be used to describe the next four sections.

(d) Error Analysis of Head Measurement

A water project was able to maintain a constant discharge long enough to obtain ten readings of head, h_1 . These readings are listed in the first column of table 3-2.

This example process provides information on repetitions of hook gage readings but does not tell the whole story about system accuracy. Good repeatability combined with poor accuracy can be likened to shooting a tight, low scoring group on the outer margin of a target. Repetition is a necessary aspect of accuracy but is not sufficient by itself.

Table 3-2. Determining sample standard deviation		
Head (h_1) (ft)	Deviation ($h_1 - h_{1AVG}$) (ft)	(Dev) ² ($h_1 - h_{1AVG}$) ² (square feet [ft ²])
1.012	-0.0011	0.00000121
1.017	0.0039	0.00001521
1.014	0.0009	0.00000081
1.010	-0.0031	0.00000961
1.015	0.0019	0.00000361
1.013	-0.0001	0.00000001
1.012	-0.0011	0.00000121
1.014	0.0009	0.00000081
1.013	-0.0001	0.00000001
1.011	-0.0021	0.00000441
$\Sigma h_1 = 10.131$	$\Sigma (h_1 - h_{1AVG}) = +0.0000$	$\Sigma (h_1 - h_{1AVG})^2 = 0.00003690$
$h_{1AVG} = 1.013$		$S = (0.00003690)^{0.5} = 0.0061$

(e) Determining the Effect of Head Measurement on Accuracy

Say a water provider or user measures a discharge of 8.96 ft³/s using a 3-ft suppressed weir with a staff gage estimating readings to ±0.01 ft. The head reading was 0.93 ft, and the water provider or user wants to investigate how much this estimate of head affects the accuracy of the discharge measurement. Assume that the reading and discharge are actual values and then add and subtract 0.01 ft to and from the 0.93-ft head reading, which gives heads of 0.94 ft and 0.92 ft. Discharges by table or equation for these new heads are 9.10 ft³/s and 8.82 ft³/s. The difference of these discharges from 8.96 ft³/s in both cases is 0.14 ft³/s, but of a different sign in each case. Thus, an uncertainty in discharge of ±0.14 ft³/s was caused by an uncertainty of ±0.01 ft in head reading. The uncertainty of the discharge measurement caused by estimating between divisions on the staff gage expressed in percent of actual discharge is calculated as follows:

$$\Delta Q\% = \frac{100(9.10 - 8.96)}{8.96} = 1.56\%$$

and:

$$\Delta Q\% = \frac{100(8.96 - 9.10)}{8.96} = 1.56\%$$

This calculation shows that estimating the staff gage ±0.01 ft contributes up to ±1.6 percent error in discharge at flows of about 9 ft³/s.

Both calculations are required because both could have been different depending on the discharge equation form and the value of discharge relative to measuring range limits.

(f) Computation to Help Select Head Measuring Device

An organization uses several 3-ft weirs and wants to decide between depending on staff gage readings or vernier hook gage readings in a stilling well. From experience, they think that the staff gage measures head to within ± 0.01 ft, and the hook gage measures to within ± 0.002 ft. The equation for the 3-ft weir in the previous example calculation is:

$$Q = 9.99h_1^{3/2} \quad (3-10)$$

Using this equation and making calculations similar to the previous example, they produce table 3-3.

It is assumed that the water provider does not want to introduce more than 2 percent error caused by precision of head measurement. This amount of error is demarcated by the stepped line through the body of table 3-3. If the water providers needed to measure flow below 7 ft³/s, they would have to use stilling wells and vernier point gages. This line shows that heads could be measured with a staff gage at locations where all deliveries exceed about 7 ft³/s. They could select a higher cut-off percentage based on expected frequency of measurements at different discharges. The results of this type of analysis should be compared to the potential accuracy of the primary part of the measuring system.

Table 3-3. Discharge deviation			
Discharge (ft ³ /s)	Equation Head (ft)	Percent deviation of discharge at calibration head at a plus Δh_1 of:	
		$\Delta h_1 \pm 0.002$ ft Deviation (%)	$\Delta h_1 \pm 0.01$ ft Deviation (%)
18	1.481	0.25	1.0
9	0.933	0.37	1.6
5	0.630	0.53	2.7
3	0.448	0.72	3.6
2	0.342	0.92	4.4
1	0.216	1.40	7.0

(g) Relationship Between Full Scale and Actual

Before buying several small acoustic flowmeters, a water provider requested that one be tested to see if the manufacturer's claim of accuracy was really true. Because the acoustic flowmeter is an electronic device, the manufacturer prefers to express calibration performance in terms of full-scale accuracy. The manufacturer claimed ± 2 percent full-scale accuracy. Full-scale percentage accuracy is defined as the difference between comparison standard measured discharge and output flowmeter discharge relative to full-scale discharge. Full-scale discharge is equivalent to the discharge upper range limit of the flowmeter. The error in percent full-scale discharge is calculated using equation 3-3.

Figure 3-2 shows the test data for the acoustic flowmeter that was checked. Full-scale discharge is $0.768 \text{ ft}^3/\text{s}$ as shown by the vertical line on the right. The standard comparison discharge was measured using a volumetric calibration tank and electronic timer which can measure discharge within 0.5 percent. This plot indicates the

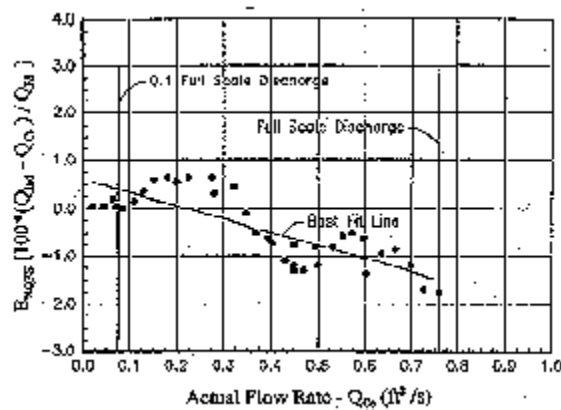


Figure 3-2 -- Percent full-scale deviation of flow rate versus actual (comparison standard) flow rate.

fit line slopes down to the right and passes through the zero error company claim of ± 2.0 -percent full-scale accuracy is true. The best axis to the left of midrange. This meter could be made to have a better full-scale accuracy by shifting the meter output vertically and/or tilting its output by electronics or computer programming.

The same data were converted and plotted in terms of percent comparison standard error of discharge using equation 3-11 on figure 3-3. To compare error in percent of actual discharge, $E_{\%Q_{act}}$, with error in percent full-scale discharge, $E_{\%Q_{FS}}$, calculated contours of equal percent full scale were also plotted on figure 3-3.

$$E_{\%Q_{act}} = \frac{100(Q_{Ind} - Q_{Cs})}{Q_{Cs}} \quad (3-11)$$

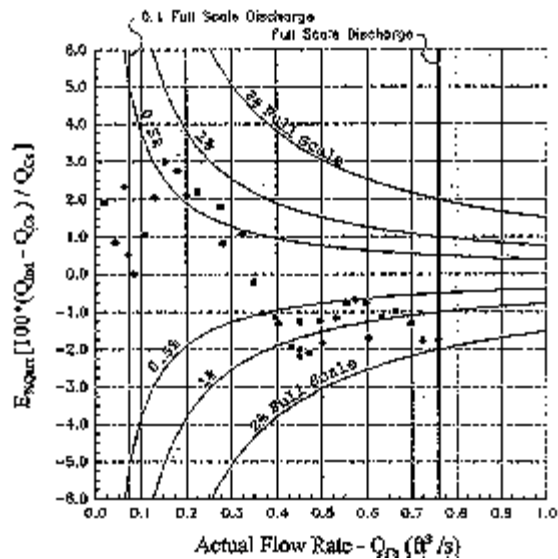


Figure 3-3 -- Comparison of actual (comparison standard) and full-scale accuracy.

(h) Percent Registration Calibration

Another way accuracy and calibration are expressed is in terms of percent registration. Calibration checks for open flow propeller meters are often presented this way. Percent registration is defined as:

$$\%R = 100 \frac{Q_{Ind}}{Q_{CS}} \quad (3-12)$$

A typical calibration check of a propeller meter mounted at the end of a pipe is plotted on figure 3-4. For this flowmeter, percent registration drops steeply below a discharge of 1 ft³/s. This result clearly indicates some of the problems of measuring near the lower range limits of this flowmeter. A slight increase of bearing friction will shift the dropping part of the curve to the right because the discharge at which the propeller will not turn will increase. Thus, in effect, the range is shortened on its low discharge end. The percent registration on the flat part of the curve near maximum registration will also decrease with age and wear of the flowmeter. In fact, the manufacturer may set meters, when they are new, to register high in anticipation of future wear. For example, they may set meters to read 3 to 5 percent high, expecting wear to lower the curve to about 100 percent registration at about mid-life of the flowmeter.

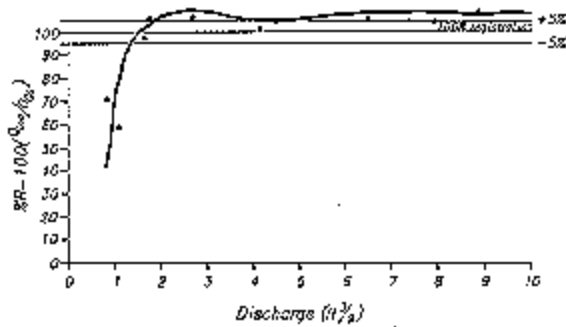


Figure 3-4 -- Percent registration form of calibration.

6. Bibliography

American Society for Testing and Materials, *Annual Book of ASTM Standards*, Water Environmental Technology, Section 11, Volume 11.01 Water (1), 1988.

American Society of Mechanical Engineers, "Performance Test Codes-Hydraulic Turbines and Turbine Mode of Pump/Turbines," revision, Performance Test Code Committee No. 18, New York: The American Society of Mechanical Engineers, PTC 18-92, 1992.

Bos, M.G. (ed.), *Discharge Measurement Structures*, third edition revised, Publication 20, International Institute for Land Reclamation and Improvement, Waneningen, The Netherlands, 1989.

Cooper, W.D., *Electronic Instrumentation and Measurement Techniques*, Prentice-Hall, New York, 1978.

International Organization for Standardization, *Measurement of Liquid Flow in Open Channels*, Handbook No. 15, Geneva, Switzerland, 1983.

U.S. Geological Survey, Office of Water Data Coordination, *National Handbook of Recommended Methods of Water-Data Acquisition*, prepared cooperatively by agencies of the United States Government, Government Printing Office, Washington DC, 1980.

Chapter 4 - SELECTION OF WATER MEASURING DEVICES

1. General Requirements

Selecting the proper water measurement device for a particular site or situation is not an easy task. Many site-specific factors and variables must be considered and weighed. In addition, each system has unique operational requirements and concerns. Reliable estimates on future demands of the proposed system and knowledge of the immediate measurement needs are beneficial. Government laws and compact agreements should be checked for possible selection constraints before selecting a measurement device. Contractual agreements for the purchase of pumps, turbines, and water measuring devices for districts often dictate the measurement system required for compliance prior to payment. These constraints may be in terms of accuracy, specific comparison devices, and procedures. Bos (1989) provides a more detailed discussion on the selection of open channel water measurement devices than the information included here. He also provides a selection flow chart and a table of water measurement device properties to guide the selection process. In this chapter, we discuss selection issues for the most common devices used in the United States.

2. Types of Measuring Devices

Irrigation system operators commonly use many types of standard water measurement devices. In this manual, the following devices are discussed in subsequent chapters:

- Weirs
- Flumes
- Submerged orifices
- Current meters
- Acoustic flowmeters
- Other open-channel devices
- Other closed conduit devices

The first four methods given above are discussed in considerable detail in this manual because they are the most common methods used. A variety of other devices for open channels and closed conduits is available-particularly for smaller rates of flow.

These devices are discussed only briefly in chapters 11 and 12. This brief discussion does not mean that they are not useful devices. Such devices are appropriate for many applications.

3. Selection Considerations

The main factors which influence the selection of a measuring device include:

- Accuracy requirements
- Cost
- Legal constraints
- Range of flow rates
- Head loss
- Adaptability to site conditions

- Adaptability to variable operating conditions
- Type of measurements and records needed
- Operating requirements
- Ability to pass sediment and debris
- Longevity of device for given environment
- Maintenance requirements
- Construction and installation requirements
- Device standardization and calibration
- Field verification, troubleshooting, and repair
- User acceptance of new methods
- Vandalism potential
- Impact on environment

(a) Accuracy

The target or desired accuracy of the measurement system is an important consideration in measurement method selection. Most water measurement devices can produce accuracies of ± 5 percent. Some devices are capable of ± 1 percent under laboratory settings. However, in the field, maintaining such accuracies usually requires considerable expense or effort (e.g., special construction, recalibration, maintenance, etc.). Selecting a device that is not appropriate for the site conditions can result in a nonstandard installation of reduced accuracy, sometimes greater than ± 10 percent.

Accuracies are usually reported for the primary measurement method or device. However, many methods rely on a secondary measurement, which typically adds error to the overall measurement. For example, the primary calibration for a weir is the relationship between head and discharge; this relationship typically contains a small error. However, the head must be measured, which potentially introduces additional error. Chapters 3 and 8 contain discussion and examples concerning the influence of secondary devices on accuracy.

(b) Cost

The cost of the measurement method includes the cost of the device itself, the installation, secondary devices, and operation and maintenance. Measurement methods vary widely in their cost and in their serviceable life span. Measurement methods are often selected based on the initial cost of the primary device with insufficient regard for the additional costs associated with providing the desired records of flows over an extended period of time.

(c) Legal Constraints

Governmental or administrative water board requirements may dictate types of accepted water measurement devices or methods. Water measurement devices which become a standard in one geographic area are often not accepted as a standard in another area. In this sense, the term "standard" does not necessarily signify accuracy or broad legal acceptance. Many water districts require certain water measurement devices used within the district to conform to their standard for the purpose of simplifying operation and maintenance.

(d) Flow Range

Many measurement methods have a limited range of flow conditions for which they are applicable. This range is usually related to the need for certain prescribed flow conditions which are assumed in the development of calibrations. Large errors in measurement can occur when the flow is outside this range. For example, using a bucket and stopwatch for large flows that engulf the bucket is not very accurate. Similarly, sharp-edged devices typically do not give good results with large flows, which are better measured with large flumes or broad-crested weirs.

In some cases, secondary devices can limit the practical range of flow rates. For example, with devices requiring a head measurement, the accuracy of the head measurement can limit the measurement of low flow rates. For some devices, accuracy is based on percent of the full-scale value. Then, at low values, the resulting accuracy is much lower, limiting the usefulness of such measurements. Generally, the device should be selected to cover the range desired. Choosing a device that can handle a larger than necessary flow rate could result in elimination of measurement capability at lower flow rates, and vice versa. For practical reasons, it may be reasonable to establish different accuracy requirements for high and low flows. Examples in chapter 3 discuss some of these problems in more detail.

(e) Head Loss

Most water measurement devices require a drop in head. On existing irrigation projects, such additional head may not be available, especially in areas with relatively flat topography. On new projects, incorporating additional head loss into the design can usually be accomplished at reasonable cost. However, a tradeoff usually exists between the cost of the device and the amount of head loss. For example, acoustic flowmeters are expensive and require little head loss; sharp-crested weirs are inexpensive but require a relatively large head loss. The head loss required for a particular measurement device usually varies over the range of discharges. In some cases, head used in measuring flow can reduce the capacity of the channel at that point.

(f) Adaptability to Site Conditions

The selection of a measurement device must consider the site of the proposed measurement. Several potential sites may be available for a given measurement; the selection of a device depends upon the exact site chosen. For example, discharge in a canal system can be measured within a reach of the channel or at a structure such as a culvert or check structure. A different device would typically be selected for each site. The device selected should not alter site hydraulic conditions so as to interfere with normal operation and maintenance. Also, the shape of the flow cross section will likely favor some devices over others. For example, the Parshall flume size selection process described in chapter 5 might result in a flume wider than the existing channel, adding substantial cost to the installation, whereas a long-throated flume might fit within the existing channel prism.

(g) Adaptability to Variable Operating Conditions

Most water delivery systems have a varying range of flows and conditions. The selected device must also be able to measure over the range of operating conditions encountered (e.g., variations in upstream and downstream head).

Devices like weirs or flumes should be avoided if downstream water levels can, under some conditions, submerge the device. In addition, the information provided by the measuring device needs to be useful for the operators performing their duties. Devices that are difficult and time consuming to operate are less apt to be used and are more likely to be used incorrectly.

In some cases, water measurement and water level or flow control need to be accomplished at the same site. A few devices are available for accomplishing both (e.g., constant-head orifice, vertically movable weirs, and Neyrpic flow module) (Bos, 1989). However, separate measurement and control devices are typically linked for this purpose. Special care is needed to assure that devices are compatible and, when used as a system, achieve both functions.

(h) Type of Measurements and Records Needed

An accurate measure of instantaneous flow rate is useful for system operators in setting and verifying flow rate. However, because flow rates change over time, a single, instantaneous reading may not accurately reflect the total volume of water delivered. Where accounting for water volume is desired, a method of accumulated individual flow measurements is needed. Where flows are steady, daily measurements may be sufficient to infer total volume. Most deliveries, however, require more frequent measurements. Totalization is essential where water users take water on demand. Totalizers and automatic recording devices are available for many measurement devices. For large structures, the cost for water-level sensing and recording hardware is small relative to the structure cost; but for small structures, these hardware costs do not change and thus become a major part of the measurement cost (often more costly than the structure itself).

Many water measurement methods are suitable for making temporary measurements (flow surveys) or performing occasional verification checks of other devices.

The method chosen for such a measurement might be quite different from that chosen for continuous monitoring. Although many of these flow survey methods are discussed in this manual, this chapter focuses on methods for permanent installations.

(i) Operating Requirements

Some measurement methods require manual labor to obtain a measurement. Current metering requires a trained staff with specialized equipment. Pen-and-ink style water-stage recorders need operators to change paper, add ink, and verify proper functioning. Manual recording of flows may require forms to be filled out and data to be accumulated for accounting purposes. Devices with manometers require special care and attention to assure correct differential head readings. Automated devices such as ultrasonic flowmeters and other systems that use transducers and electronics require operator training to set up, adjust, and troubleshoot problems. Setting gate controlled flow rates by simple canal level references or by current metering commonly requires several hours of waiting between gate changes for the downstream canal to fill and stabilize. However, flumes and weirs serve to quickly reach measured flow rate without waiting for the downstream canals to fill to stable conditions. The requirements of the operating personnel in using the devices and techniques for their desired purposes can be easily overlooked and must be considered in meter selection.

(j) Ability to Pass Sediment and Debris

Canal systems often carry a significant amount of sediment in the water. Removal of all suspended solids from the water is usually prohibitively expensive. Thus, some sediment will likely be deposited anywhere the velocities are reduced, which typically occurs near flow measuring structures. Whether this sediment causes a problem depends on the specific structure and the volume of sediment in the water. In some cases, this problem simply requires routine maintenance to remove accumulated sediment; in others, the accumulation can make the flow measurement inaccurate or the device inoperative. Sediment deposits can affect approach conditions and increase approach velocity in front of weirs, flumes, and orifices. Floating and suspended debris such as aquatic plants, washed out bank plants, and debris such as fallen tree leaves and twigs can plug some flow measurement devices and cause significant flow measurement problems. Many of the measurement devices which are successfully used in closed conduits (e.g., orifices, propeller meters, etc.) are not usable in culverts or inverted siphons because of debris in the water. Attempting to remove this debris at the entrance to culverts is an additional maintenance problem.

(k) Device Environment

Any measurement device with moving parts or sensors is subject to failure if it is not compatible with the site environment. Achieving proper operation and longevity of devices is an important selection factor. Very cold weather can shrink moving and fixed parts differentially and solidify oil and grease. Water can freeze around parts and plug pressure ports and passageways. Acidity and alkalinity in water can corrode metal parts. Water contaminants such as waste solvents can damage lubricants, protective coatings, and plastic parts.

Mineral encrustation and biological growths can impair moving parts and plug pressure transmitting ports. Sediment can abrade parts or consolidate tightly in bearing and runner spaces in devices such as propeller meters. Measurement of wastewater and high sediment transport flow may preclude the use of devices that require pressure taps, intrusive sensors, or depend upon clear transmission of sound through the flow. Water measurement devices that depend on electronic devices and transducers must have appropriate protective housings for harsh environments. Improper protection against the site environment can cause equipment failure or loss of accuracy.

(l) Maintenance Requirements

The type and amount of maintenance varies widely with different measurement methods. For example, current metering requires periodic maintenance of the current meter itself and maintenance of the meter site to assure that it has a known cross section and velocity distribution. When the flow carries sediment or debris, most weirs, flumes, and orifices require periodic cleaning of the approach channel. Electronic sensors need occasional maintenance to assure that they are performing properly. Regular maintenance programs are recommended to ensure prolonged measurement quality for all types of devices.

(m) Construction and Installation Requirements

In addition to installation costs, the difficulty of installation and the need to retrofit parts of the existing conveyance system can complicate the selection of water measurement devices. Clearly, devices which can be easily retrofit into the existing canal system are much preferred because they generally require less down time, and unforeseen problems can be avoided.

(n) Device Standardization and Calibration

A standard water measurement device infers a documented history of performance based on theory, controlled calibration, and use. A truly standard device has been fully described, accurately calibrated, correctly constructed, properly installed, and sufficiently maintained to fulfill the original installation requirements and flow condition limitations. Discharge equations and tables for standard devices should provide accurate calibration. Maintaining a standard device usually only involves a visual check and measurement of a few specified items or dimensions to ensure that the measuring device has not departed from the standard. Many standard devices have a long history of use and calibration and, thus, are potentially more reliable. Commercial availability of a device does not necessarily guarantee that it satisfies the requirements of a standard device.

When measuring devices are fabricated onsite or are poorly installed, small deviations from the specified dimensions can occur. These deviations may or may not affect the calibration. The difficulty is that unless an as-built calibration is performed, the degree to which these errors affect the accuracy of the measurements is unknown. All too frequently, design deviations are made under the misconception that current metering can be used to provide an accurate field calibration. In practice, calibration by current metering to within ± 2 percent is difficult to attain.

An adequate calibration for free-flow conditions requires many current meter measurements at several discharges. Changing and maintaining a constant discharge is often difficult under field conditions.

(o) Field Verification, Troubleshooting, and Repair

After construction or installation of a device, some verification of the calibration is generally recommended. Usually, the methods used to verify a permanent device (e.g., current metering) are less accurate than the device itself. However, this verification simply serves as a check against gross errors in construction or calibration. For some devices, errors occur as components wear and the calibration slowly drifts away from the original. Other devices have components that simply fail - that is, you get the correct reading or no reading at all. The latter is clearly preferred. However, for many devices, occasional checking is required to assure that they are still performing as intended. Selection of devices may depend on how they fail and how easy it is to verify that they are performing properly.

(p) User Acceptance of New Methods

Selection of a water measurement method must also consider the past history of the practice at the site. When improved water measurement methods are needed, proposing changes that build on established practice are generally easier to institute than radical changes. It can be beneficial to select a new method that allows conversion to take place in stages to provide educational examples and demonstrations of the new devices and procedures.

(q) Vandalism Potential

Instrumentation located near public access is a prime target for vandalism. Where vandalism is a problem, measurement devices with less instrumentation, or instrumentation that can be easily protected, are preferred. When needed, instrumentation can be placed in a buried vault to minimize visibility.

(r) Impact on Environment

During water measurement device selection, consideration must be given to potential environmental impacts. Water measurement devices vary greatly in the amount of disruption to existing conditions needed to install, meet standard upstream and downstream conditions, operate, and maintain. For example, installing a weir or flume constricts the channel, slows upstream flow, and accelerates flow within the structure. These changes in the flow conditions can alter local channel erosion, local flooding, public safety, local aquatic habitat, and fish movement up and down the channel. These factors may alter the cost and selection of a measurement device.

4. Selection Guidelines

Selection of a water measurement method can be a difficult, time-consuming process if one were to formally evaluate all the factors discussed above for each measuring device. Of course, this difficulty is one reason that standardization of measurement devices within a district is so popular. However useful devices are sometimes overlooked when similar devices are automatically selected. The purpose of this chapter is to provide some preliminary guidance on selection so that the number of choices can be narrowed down before a more thorough analysis of the tradeoffs between alternatives is performed.

(a) Short List of Devices Based on Application

Site conditions for a water measurement device quickly narrow the list of possible choices, because most devices are only suitable under a limited number of channel or conduit conditions. Table 4-1 provides a list of the most commonly used measurement methods for each of several applications.

Table 4-2 provides an abbreviated table of selection criteria and general compliance for categories of water measurement devices. The symbols (+), (0), and (-) are used to indicate relative compliance for each selection criteria.

The (+) symbol indicates positive features that might make the device attractive from the standpoint of the associated selection criteria. A (-) symbol indicates negative aspects that might limit the usefulness of this method based on that criteria. A (0) indicates no strong positive or negative aspects in general. A (v) means that the suitability varies widely for this class of devices. The letters (na) mean that the device is not applicable for the stated conditions. A single negative value for a device does not mean that the device is not useful and appropriate, but other devices would be preferred for those selection criteria.

Table 4-1 - Application-based selection of water measurement devices

1. Open channel conveyance system
 1. Natural channels
 1. Rivers
 1. Periodic current metering of a control section to establish stage-discharge relation
 2. Broad-crested weirs
 3. Long-throated flumes
 4. Short-crested weirs
 5. Acoustic velocity meters (AVM - transit time)
 6. Acoustic Doppler velocity profiles
 7. Float-velocity/area method
 8. Slope-area method
 2. Intermediate-sized and small streams
 1. Current metering/control section
 2. Broad-crested weirs
 3. Long-throated flumes
 4. Short-crested weirs
 5. Short-throated flumes
 6. Acoustic velocity meters (AVM - transit time)
 7. Float-velocity/area method
 2. Regulated channels
 1. Spillways
 1. Gated
 1. Sluice gates
 2. Radial gates
 2. Ungated
 1. Broad-crested weirs (including special crest shapes, Ogee crest, etc.)
 2. Short-crested weirs
 2. Large canals
 1. Control structures
 1. Check gates
 2. Sluice gates
 3. Radial gates
 4. Overshot gates

Table 4-1 - Application-based selection of water measurement devices (Cont.)

2. Other
 1. Long-throated flumes
 2. Broad-crested weirs
 3. Short-throated flumes
 4. Acoustic velocity meters
3. Small canals (including open channel conduit flow)
 1. Long-throated flumes
 1. Broad-crested weirs
 2. Short-throated flumes
 1. Sharp-crested weirs
 3. Rated flow control structures (check gates, radial gates, sluice gates, overshot gates)
 4. Acoustic velocity meters
 5. Other
 1. Float-velocity area methods
4. Farm turnouts
 1. Pipe turnouts (short inverted siphons, submerged culverts, etc.)
 1. Metergates
 2. Current meters
 3. Weirs
 4. Long-throated flumes
 5. Short-throated flumes
 2. Other
 1. Constant head orifice
 2. Rated sluice gates
 3. Movable weirs
2. Closed conduit conveyance systems
 1. Large pipes
 1. Venturi meters
 2. Rated control gates (orifice)
 3. Acoustic velocity meters (transit time)
 2. Small and intermediate-sized pipelines
 1. Venturi meters
 2. Orifices (in-line, end-cap, shunt meters, etc.)
 3. Propeller and turbine meters
 4. Magnetic meters
 5. Acoustic meters (transit-time and doppler)
 6. Pitotmeters
 7. Elbow meters
 8. Trajectory methods (e.g., California pipe method)
 9. Other commercially available meters

Table 4-2. Water measurement device selection guidelines. Symbols +, 0, Care used as relative indicators comparing application of water measurement devices to the listed criteria ("v" denotes device suitability varies widely, "na" denotes not applicable to criteria)

Device	Accuracy	Cost	Flows >150 ft ³ /s	Flows <10 ft ³ /s	Flow span	Head loss	Site conditions			
							Lined canal	Unlined canal	Short full pipe	Closed conduit
Sharp-crested weirs	0	0	-	+	0	-	-	0	na	na
Broad-crested weirs	0	+	+	+	+	0	+	0	na	na
Long-throated flumes	0	0	+	+	+	0	+	0	na	na
Short-throated flumes	0	-	-	0	0	-	-	0	na	na
Submerged orifices (in channels)	0	0	-	+	-	-	0	0	na	na
Current metering	-	-	+	-	-	+	0	-	na	na
Acoustic velocity meters in an open channel	-	0	0	-	0	+	0	0	na	na
Radial and sluice gates	-	+	0	0	-	-	+	+	+	na
Propeller meters at pipe exit	-	+	-	0	0	+	0	0	+	+
Differential head meters for pipe ¹	+	-	-	+	-	V	na	na	0	+
Mechanical velocity meters for pipe ²	0	+	-	0	0	+	na	na	0	+
Magnetic meters for pipe	0	0	-	0	0	+	na	na	-	+
Acoustic Doppler ultrasonic meters for pipe	-	0	-	-	-	+	na	na	-	+
Acoustic flowmeter pipe (single path)	0	-	0	0	0	+	na	na	-	+
Acoustic flowmeter pipe (multipath)	+	-	+	0	+	+	na	na	-	+

¹ Venturi, orifice, pitot tube, shunt meters, etc.

² Propeller meters, turbine meters, paddle wheel meters, etc.

Table 4-2 - Water measurement device selection guidelines. Symbols +, 0, Care used as relative indicators comparing application of water measurement devices to the listed criteria ("v" denotes device suitability varies widely, "na" denotes not applicable to criteria) (continued)

Device	Measurements		Sediment/Debris		Longevity		Maintenance	Construction	Field verify	Standardization
	Rate	Volume	Sediment pass.	Debris pass.	Moving parts	Electricity needed				
Sharp-crested weirs	+	-	-	-	+	+	0	-	0	+
Broad-crested weirs	+	-	0	+	+	+	+	+	+	0
Long-throated flumes	+	-	0	+	+	+	+	0	+	0
Short-throated flumes	+	-	0	+	+	+	+	-	-	+
Submerged orifices (in channels)	+	-	-	-	+	+	+	0	+	0
Current metering	+	-	+	+	0	0	0	+	0	+
Acoustic velocity meters in an open channel	+	0	+	+	0	-	-	+	-	-
Radial and sluice gates	+	-	0	-	+	0	+	+	-	-
Propeller meters at pipe exit	0	+	0	-	-	0	-	+	0	0
Differential head meters for pipe ¹	+	-	-	v	+	0	0	0	+	+
Mechanical velocity meters for pipe ²	v	v	-	-	-	0	-	0	0	0
Magnetic meters pipe	+	0	0	0	0	-	-	0	-	0

Acoustic Doppler ultrasonic meters for pipe	+	0	0	0	0	-	-	0	-	-
Acoustic flowmeter pipe (single path)	0	+	0	0	0	-	-	-	-	0
Acoustic flowmeter pipe (multipath)	+	+	0	0	0	-	-	-	-	+
¹ Venturi, orifice, pitot tube, shunt meters, etc. ² Propeller meters, turbine meters, paddle wheel meters, etc.										

The process of narrowing down options might start with table 4-1 to examine the main methods to consider. Table 4-2 can then be used to get an idea of the general positive and negative features of various methods. In narrowing down the options, different applications will place different weight on the selection criteria, so no universally correct selection exists. Finally, a preliminary design for several candidate methods selected should be performed so that details on cost, hydraulics, operations, etc., can be more thoroughly examined C followed by final selection, design, and construction.

(b) Example

We want to measure the flow entering a small farm turnout ditch that serves an agricultural field. The ditch is trapezoidal, concrete-lined and has a rectangular metal sluice gate that is opened by hand to divert flow into the ditch from a canal lateral. No power is available at the site. The ditch carries a flow of about 10 cubic feet per second (ft³/s). Field survey measurements taken during an irrigation indicate about a 0.75-ft drop in the water surface from the gate to the downstream channel. The irrigation flow transports fine sediment and numerous tumble-weeds. Water is diverted to the field on a 2-week rotation for a period of about 24 hours. The measurement device will be used to establish a known flow rate through the headgate for crop yield management and water use accounting. Typically, the water surface in the lateral remains fairly constant during an irrigation; therefore, a single measurement per irrigation will meet current needs. However, in the future, more frequent measurements may be desired. The irrigator would like to install a device that costs less than \$500.

Table 4-1 identifies a number of devices that are typically used for farm turnouts. Our site requires we select a device or method that can be used in an open channel. Therefore, common measurement devices given for this application are: current meters, weirs, flumes, and rated sluice gates (headgates). Next, the advantages or disadvantages for each of these devices should be considered with respect to the measurement goals and the site conditions. Table 4-2 is used to assist in comparing the attributes of devices.

Typically, only a few selection constraints are high priorities. The selection priorities for the example are likely: meeting available head, cost, accuracy, and debris passage goals. Head loss is the highest priority because it is a physical constraint of the site that must be met to provide good measurement. Current meters provide the least head loss followed by long-throated flumes (including broad-crested weirs), short-throated flumes, and sharp-crested weirs. Sluice gates rate low in terms of head loss; however, for this application, the gate is part of the site and will not provide additional head loss. Based on our highest priority, current metering, a long-throated flume or rating the headgate are good choices. Next, consider the cost of devices including: initial cost, data collection time, and maintenance. Rating the headgate and a long-throated flume are considered to be a lower cost than current metering largely because of the time involved in data collection. Accuracy of measurement and debris passage favor a long-throated flume.

This example selection process identifies a long-throated flume as potentially the best device followed by rating of the headgate. These two methods of measurement are recommended for additional detailed design and evaluation prior to the final selection.

5. Bibliography

Bos, M.G., (ed.), *Discharge Measurement Structures*, third revised edition, International Institute for Land Reclamation and Improvement, Publication No. 20, Wageningen, The Netherlands, 1989.

CHAPTER 5 - INSPECTION OF WATER MEASUREMENT SYSTEMS

1. Background and Scope

Irrigation system deterioration can exist for years before becoming apparent to frequent users. However, an observer viewing an installation for the first time or infrequently may spot the deterioration immediately. Thus, water users and providers are often surprised to find that their water measurements are unacceptable because their system and measuring devices have deteriorated. Regular and careful inspections with the specific intent of finding deterioration in early stages will help prevent this unpleasant surprise. These inspections will also help reveal changing delivery needs that require other types of measuring devices and disclose other possible errors of operation. Another problem is that operators do not always know or use proper techniques to obtain accurate measurements. The best way to handle this problem is to provide good training.

This chapter shows water users and providers what to consider and check during system inspections to help maintain accurate water deliveries. Users can protect water rights and prevent overcharging by understanding these same considerations.

The performance of weirs and flumes will be used to illustrate flow and accuracy principles because irrigation operators will likely be more familiar with their use. Also, many of the factors which adversely affect accuracy are visible on these devices but are hidden in closed conduit devices. Many of the factors and principles established for weirs and flumes also apply to other water measuring devices. These principles are elaborated upon in forthcoming sections concerning specific devices.

2. Standard Devices Versus Nonstandard Devices

The use of standard devices usually results in lower total costs over the lifetime of a measurement structure. Their long general use has generated more backup data and experience, making them potentially more reliable. A truly standard device has been fully described, accurately calibrated, correctly made or installed, and sufficiently maintained to fulfill the original requirements. Standard discharge equations and tables or curves may then be relied upon to provide accurate water measurements. Maintaining a standard device involves only a visual check and measurement of a few specified items or dimensions to ensure that the measuring device has not departed from the standard.

Even though a standard device might have been selected for a particular measurement situation, water providers and users frequently find themselves unexpectedly stuck with nonstandard and, at times, unusable devices. This situation can occur when a device is installed improperly, is poorly maintained, is operated above or below the prescribed discharge limits, or has poor approach or downstream submergence conditions.

Accurate discharges from nonstandard structures can be obtained only from specially prepared curves or tables based on calibration tests, such as multiple current-meter ratings. The accuracy of a nonstandard device cannot be determined by visual inspection. Accuracy can only be ensured by recalibration, which is costly when properly performed. Ratings must be made at close discharge intervals over the complete operating range.

Then, curves and/or tables must be prepared. Installation and proper inspection and maintenance of standard devices are not difficult and are less costly in the long run. Standard discharge tables may then be used with full confidence.

3. Approach Flow

Poor flow conditions in the area just upstream from the measuring device can cause large discharge indication errors. In general, the approaching flow should be tranquil. Tranquil flow is defined as fully developed flow in long, straight channels with mild slopes, free of close curves, projections, and waves. Venturi meters require 10 diameters of straight pipe approach. By analogy, open channel flow would require 40 hydraulic radii of straight, unobstructed approach.

A good example of practical approach criteria taken from Bos (1989) follows:

- If the control width is greater than 50 percent of the approach channel width, then 10 average approach flow widths of straight, unobstructed approach are required.
- If the control width is less than 50 percent of the approach width, then 20 control widths of straight, unobstructed approach are required.
- If upstream flow is below critical depth, a jump should be forced to occur. In this case, 30 measuring heads of straight, unobstructed approach after the jump should be provided.
- If baffles are used to correct and smooth out approach flow, then 10 measuring heads should be placed between the baffles and the measuring station.

Deviation from a normal transverse or vertical flow distribution, or the presence of water surface boils, eddies, or local fast currents, is reason to suspect the accuracy of the measuring device. Errors of 20 percent are common, and errors as large as 50 percent or more may occur if the approach flow conditions are very poor. Sand or gravel bars, weed growths, or slumped riprap obstructions along the banks or in the flow area can cause nonsymmetrical approach flow. Inadequate distance downstream from a drop, check, or slide gate will concentrate flow locally and cause error. A bend or angle in the channel just upstream from the measuring device or a rapid expansion in the flow section can cause secondary flow or large eddies, which tend to concentrate the flow in part of a cross section.

Figure 5-1 shows an example of a poor flow distribution in the approach to a weir. The high-velocity, turbulent stream is approaching the weir at a considerable angle. The high-velocity approach flow and the waves on the surface hinder head measurement. With this poor approach flow, the weir will not produce the same head-discharge relationship as its standard equation and calibration table.



Figure 5-1 -- Example of poor approach flow conditions upstream from weir.

Standard weir proportions for rectangular, Cipoletti, and 90-degree V-notch weirs are shown on figure 5-2. The approach velocity toward weirs should be less than 0.5 foot per second (ft/s). This velocity value is equivalent to a head error of 0.005 ft. Velocity of approach can be estimated by dividing the maximum discharge by the area at a point 4 to 6 measuring heads upstream from the blade. Excess approach velocity is commonly caused by violating the criteria specified in chapter 7.

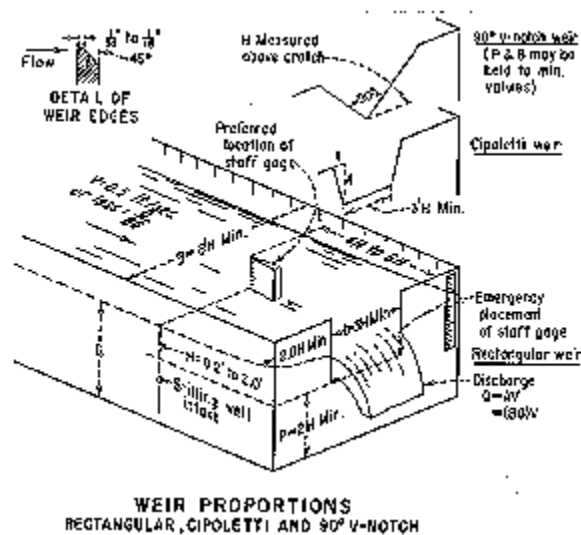


Figure 5-2 -- Weir proportions.

4. Turbulence

Turbulence results from relatively small parcels of water spinning in a random pattern within the bulk flow while moving downstream. Turbulence may be recognized as water surface boils or three dimensional eddies which appear and disappear haphazardly. Because of this local motion within the general motion of the bulk flow, any particle of water may, at any given instant, move forward, sideways, vertically, or even backward. In effect, the water is passing a given point with accelerating and decelerating motion superimposed upon the main flow rather than with a uniform, ideal velocity. Thus, more or less water may pass a given point over a short length for short time periods, depending on the observation point chosen ([figure 5-1](#)).

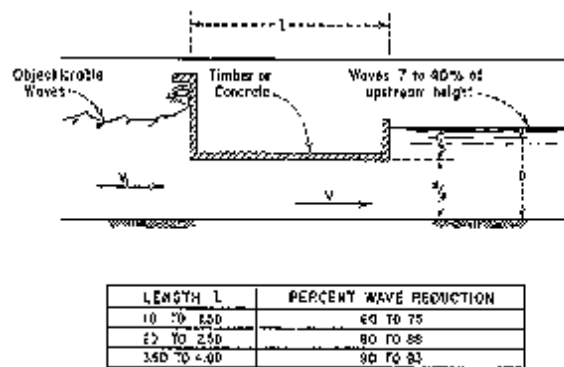
Excessive turbulence will adversely affect the accuracy of any measuring device but is particularly objectionable when using current meters or propeller meters of any kind. Turbulence can be objectionable even without air entrainment or the "white water" often associated with turbulence. Turbulence is commonly caused by stilling basins or other energy dissipaters, by a sudden drop in water surface, or by obstructions in the flow area such as turnouts-- operating or not--that have projections or indentations from the supply canal. Shallow flow passing over a rough or steep bottom can also cause turbulence. Weeds or riprap slumped into the flow area or along the banks, or sediment deposits upstream from the measuring device, also can cause excessive turbulence.

Excessive turbulence can cause measuring errors of 10 percent or more. Therefore, the flow approaching a measuring structure or device should be modified to resemble tranquil canal flow.

5. Rough Water Surface

Reducing turbulence or improving approach flow distribution can eliminate rough water surfaces that are not caused by wind. A rough water surface can cause errors in discharge measurements when a staff gage must be read to determine head or cross-sectional area of the flow. A stilling well will help reduce errors in head measurement, but every attempt should be made to reduce the water surface disturbances as much as possible before relying on the well. Errors of 10 to 20 percent are common where a choppy water surface impedes accurate head determination. The area of piping to a stilling well should be about one-hundredth of the well area to dampen water surface oscillations. A larger area of piping may be needed to eliminate debris plugging or increase well response to changes in measuring head. A smaller area may be needed to dampen overly rough flow.

Specially constructed wave damping devices (Schuster, 1970) are often required to obtain a smooth water surface. Figure 5-3 shows a schematic of an underpass type of wave suppressor successfully used in both large and small channels.



UNDERPASS WAVE SUPPRESSOR SECTION
Figure 5-3 -- Underpass wave suppressor.

The channel may be either rectangular or trapezoidal in cross section. Constructing the suppressor four times as long as the flow is deep can reduce waves as much as 93 percent. The suppressor produces a slight backwater effect for the most effective vertical placement. The suppressor may be supported on piers, can be constructed of wood or concrete, and need not be watertight.

The design of several other suppressor types, along with example cases, is covered in Peterka (1983). Figure 5-4 shows turbulence and waves in a Parshall flume produced by an outlet works stilling basin, which makes accurate discharge determination impossible. The log raft in the foreground was used in an attempt to quiet the flow; however, the raft was later lifted out of the water because of ineffectiveness.



Figure 5-4 -- Turbulence and waves in a Parshall flume produced by an outlet works stilling basin. The log raft failed to quiet the flow.

Figure 5-5 shows the water surface after removal of the log raft and installation of an underpass-type wave suppressor. This modification significantly reduced the turbulence and waves, making accurate discharge determination a routine matter.

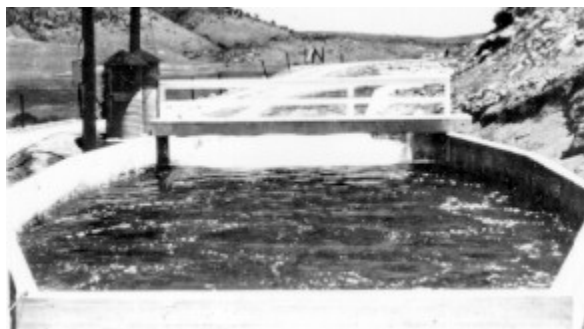
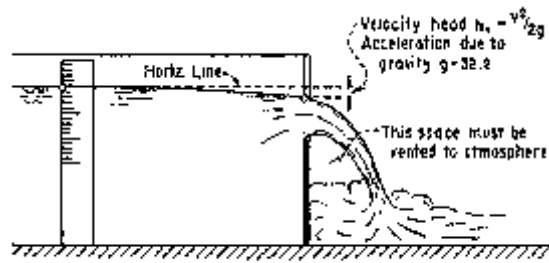


Figure 5-5 -- Underpass-type wave suppressor reduces turbulence and waves in Parshall flumes.

6. Velocity Head in Approach

As flow approaches a weir, the water surface becomes lower due to acceleration of the flow by the force of gravity (figure 5-6).



SECTION ON LONGITUDINAL CENTERLINE

Figure 5-6 -- Weir approach flow.

The water surface is considerably lower at the weir blade than it is at 5 ft upstream. The elevation difference between the two circled points on the surface of the approach flow is called the velocity head and represents the potential required to produce the increase in velocity between the points.

A drop in water surface of 0.1 ft is common just upstream from a weir and (from the equation above) represents an increase in velocity of 0.8 ft/s. If the head on the weir is measured too close to the weir, the head measurement can be up to 0.1 ft too small. For a weir 6 ft long, with a head of 0.45 ft, a discharge of 7 ft³/s is indicated. If you measured the head too close to the weir, such that the head was reduced by 0.1 ft, a discharge of 5 ft³/s would be indicated. This difference amounts to an error of about 35 percent based on the reported discharge; and, more importantly, the water provider would be giving away 2 ft³/s.

Standard weir tables are based on the measured head of the weir (velocity head is negligible) and do not compensate for excessive velocity head. Any increase in velocity above standard conditions, therefore, will result in measuring less than the true head on the weir. Therefore, more water will be delivered than is measured. Causes of excessive velocity head include inadequate pool depth upstream from the weir, deposits in the upstream pool (figure 5-7), and poor lateral velocity distribution upstream from the weir.



Figure 5-7 -- Sediment deposits in weir pool.

Figure 5-7 shows sediment deposits, which have reduced the depth of the weir significantly and increased the velocity of the approach to well above the desirable level. Other problems exist as well; the head gage should not be located this close to the weir blade, the weeds should be removed, and the "edge" of the weir should be sharp. Discharges over this weir will be larger than indicated in "standard" tables.

7. Poor Flow Patterns

The poor flow distribution which exists upstream from a measuring device often cannot be attributed to any one of the causes discussed above. The best solution, then, is to assume that the poor distribution has several causes. Start with the easy factors, work through the list, and address each probable cause of poor flow patterns until obtaining the desired flow conditions.

Turnouts located close to and upstream from a measuring device may cause poor approach conditions, as may bridge piers, channel curves, or a skewed measuring section. Relocating the measuring device may be the only remedy in these cases.

Submerged weeds or debris can cause excessive turbulence or local high velocity currents. Eddies adjacent to the shoreline can cause the flow approaching the weir to contract into a narrow band. Sediment bars deposited from inflow or from sloughing banks can also produce undesirable flow conditions. More drastic remedial measures include deepening the approach area, widening the approach channel to make it symmetrical, or introducing baffles or other devices to spread the incoming flow over the entire width of the approach. However, 10 channel widths of straight, unobstructed approach should lie between baffles or other devices placed before the measuring device. Surface waves, which are usually difficult to reduce or eliminate by ordinary procedures, may require special treatment, as discussed under "Rough Water Surface" in section 5.

8. Exit Flow Conditions

Exit flow conditions can cause as much flow measurement error as approach flow problems. However, these conditions are not encountered as often in practice. In general, ensuring that backwater does not submerge or drown out a device designed for free flow is sufficient. Occasionally, a flume is set too low, and backwater submerges the throat excessively, which can introduce extremely large errors in discharge measurement. The only remedy is to raise the flume, unless some local obstruction downstream can be removed to reduce the backwater. Sharp-crested weirs should discharge freely rather than submerged, although a slight submergence (the backwater may rise above the crest up to 10 percent of the head) reduces the discharge a negligible amount (less than 1 percent). However, a weir operated near submergence may not affect the discharge as much as the possible lack of nappe ventilation resulting from high downstream depth or intermittent waves lapping the underside of the nappe.

The underside of weir nappes should be ventilated sufficiently to provide near atmospheric pressure beneath the nappe, between the under-nappe surface, and the downstream face of the weir. The height of pull-up behind the nappe depends upon the drop, discharge, and crest length. The height that the water raises behind the nappe is a measure of the discharge error. For example, if the measuring head on a 3-ft suppressed weir is 1 ft and the water behind the nappe pulls up 0.3 ft, the error of discharge measurement would be about +6.5 percent. If the water was only pulled up 0.1 ft, the error for the same weir and measuring head would be +2.5 percent.

If the head upstream from the weir is pulled down a significant amount, then the weir is not sufficiently ventilated. An easy test for sufficient ventilation is to part the nappe downstream from the blade for a moment with a hand or a shovel to allow a full supply of air to enter beneath the nappe. After removing the hand or shovel, the nappe should not gradually become depressed (over a period of several or more minutes) toward the weir blade. If the upper nappe profile remains the same as it was while fully ventilated, the weir has sufficient ventilation.

If the nappe clings to the downstream side of the weir and does not spring clear, the weir may discharge up to 25 percent more water than the head reading indicates. This problem is generally a low flow problem with heads near and less than 0.2 ft and occurs more frequently with V-notch weirs. Good practice would involve checking the nappe before and after readings.

Gates calibrated only for free discharge at partial openings should not be submerged, nor should eddies interfere with the jet of water issuing from the gate. Gaging stations should be kept free of deposited sediment bars or other side-projecting obstructions to prevent backflow or eddies from interfering with the uniform flow conditions that should exist in the cross section being measured.

9. Weathered and Worn Equipment

Sharp-crested weir blades on older water measuring devices are often in bad condition. Weir blades are seen with dull and dented edges, discontinuous with bulkheads, pitted and covered with rust tubercles, and not vertical. Weir blades have sagged and are no longer level. Staff gages are worn and difficult to read. Stilling well intakes are buried in sediment or partly blocked by weeds or debris. Broad-crested weirs and flumes are frost heaved and out of level. Meter gates are partly clogged with sand or debris, and gate leaves are cracked and warped. These and other forms of deterioration often cause serious errors in discharge measurements. This type of deficiency is difficult to detect because, as mentioned before, deterioration occurs slowly.

Therefore, the person responsible for measuring devices must inspect them with a critical eye. The attitude should be: "I am looking for trouble," rather than: "I will excuse the little things because they are no worse today than they were yesterday." A series of little problems has often accumulated and compounded into large, unknown, and unaccountable errors. Poorly maintained measuring devices are no longer standard, and indicated discharges may be considerably in error. Worn devices should be rehabilitated to ensure true discharge readings.

Repairing or refurbishing a rundown measuring device is sometimes a difficult or impossible task. Fixing small problems as they occur will prevent, in many cases, replacing the entire device on an emergency basis, perhaps at great cost at some later date. Regular preventive maintenance will extend the useful life of measuring devices.

10. Poor Installation and Workmanship

Contrasting with the measurement devices that were once accurate and dependable but have deteriorated are those that, because of poor workmanship, were never installed properly. This category includes devices that are installed out of level or out of plumb, those that are skewed or out of alignment, those that have leaking bulkheads with flow passing beneath or around them, and those that have been set too low or too high for the existing flow conditions.

Inaccurate weir blade lengths or Parshall flume throat widths, insufficient or nonexistent weir nappe ventilation, or incorrectly located and zeroed head or staff gages cause measuring errors.

A transverse slope on a sharp-crested weir blade can cause errors, particularly if the gage zero is referenced to either end. The error can be minimized by determining the discharge based on the head at each end and using the average discharge. Errors in setting the gage zero are the same as misreading the head by the same amount. At low heads, a relatively small zero setting error can cause errors of 50 percent or more in the discharge. A head determination error of only 0.01 ft can cause a discharge error of from 5 percent on a 90degree V-notch weir to over 8 percent on a 48inch (in) Cipoletti weir (both for a head of 0.20 ft). The same head error on 6 and 12in Parshall flumes can result in 12- and 6-percent errors, respectively, for low heads.

Out of plumb or skewed weir blades will show flow measurement inaccuracies of measurable magnitude if the weir is out of alignment by more than a few degrees. Rusted or pitted weir blades or those having projecting bolts or offsets on the upstream side can cause errors of 2 percent or more depending on severity of the roughness. Any roughness will cause the weir to discharge more water than indicated. Rounding of the sharp edge of a weir or reversing the face of the blade also tends to increase the discharge. On older wood crests, a well rounded edge can cause a 15- to 25-percent or more increase in discharge (figure 5-8). The well-rounded edge on the once sharp-crested weir on figure 5-8 will increase the discharge to well above "standard." The weeds are also undesirable, as is the weir gage which projects into the flow area.



Figure 5-8 -- Poorly maintained weir edge.

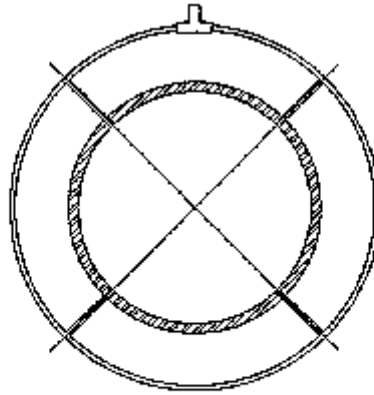
Certain types of meters require pressure readings to determine discharges. Piezometers, or pressure taps, as they are sometimes called, must be regarded with suspicion when considering flow measurement accuracy.

Piezometers or pressure head taps must be installed with care and with a knowledge of how they perform; otherwise, indicated pressure values can be in error. For example, as shown on figure 5-9, the four piezometers indicate different pressure readings (water levels) because of the manner in which flow passes the piezometer opening. Piezometer openings are shown larger than they should be constructed in practice. Always use the smallest diameter opening consistent with the possibility of clogging by foreign material. Unless the piezometer is vertical as in Y, the water elevation will be drawn down as in X or increased as in Z. Basically, pressure taps should be perpendicular to the flow boundary, and the flow must be parallel to the boundary. Rough edges or burrs on or near the edges of the piezometer holes deflect the water into or away from the piezometer, causing erroneous indications. The case as in W shows the tube pushed into the flow, causing the flow to curve under the tip which pulls the water level down. Errors caused by faulty piezometer tap installation increase with velocity.

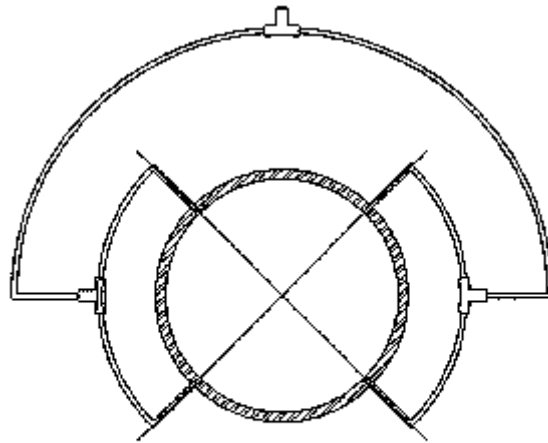


Figure 5-9 -- Examples of piezometer installation.

Sometimes, to obtain a better average pressure reading, four taps around the pipe are manifolded. If unbalanced pressure exists because of velocity distribution, error can be introduced by flow circulation in the manifolding tubing. Two forms of manifolding are shown on figure 5-10. The commonly seen case (a)-circular form-causes circulation errors. Case (b) is the triple tee system, designed to minimize circulation errors. Large tube diameter relative to piezometer hole diameter through the meter wall will reduce circulation error considerably for both cases.



(a) Circular



(b) Triple - Tee

Figure 5-10 -- Examples of piezometer manifold tubing (top: poor arrangement; bottom: good compensating arrangement). Large-diameter tubing relative to piezometer diameter will reduce circulation errors considerably for both cases.

Frequently, pressure taps are connected to manometers and U-tubes (figure 5-11), and air trapped in the tubing can cause large errors. Air travels in bubbles that tend to rise and form large air blockages. Thus, piezometers should not be connected at the top of a pipe. Even with taps on the side, air will come out of solution as water warms. Air in the vertical parts of the tubing causes large errors. Although air in horizontal parts of the tubing does not cause error, a bubble will likely move to a vertical part of the tubing when flow increases or decreases. For bleeding air, flowmeters should be placed at locations where the pipelines are under positive pressure; that is, where the hydraulic grade line is well above the pipe and manometry system as shown on figure 5-11.

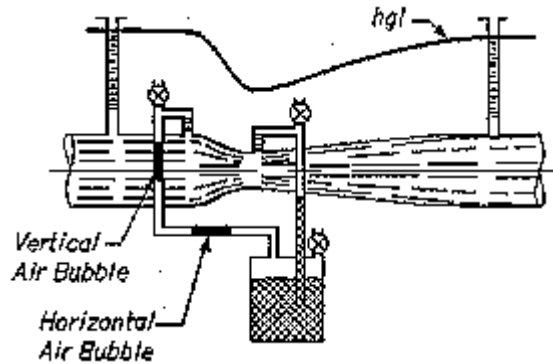


Figure 5-11 -- Manometry system below the hydraulic grade line is desirable.

If the meter and/or manometer are above the grade line as shown on figure 5-12, then pressure is negative. Negative pressure causes air to come out of solution and accumulate. Also, air can leak through pipe fittings and flange gaskets into the pipe and manometer system. Air can leak through openings that water cannot leak through.

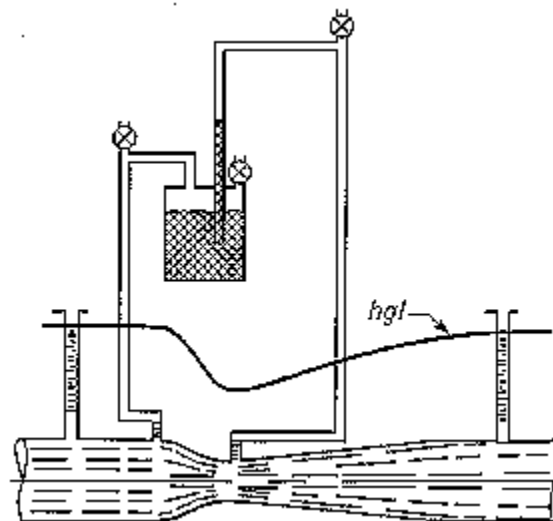


Figure 5-12 -- Manometry system above the hydraulic grade line is undesirable.

Care in designing the system should be taken to make sure that the hydraulic grade line is above the tubing system at maximum water delivery. Otherwise, bleeding will have to be done frequently with separate water source purging, or water delivery will have to be shut off to provide positive pressure during bleeding. When the hydraulic grade line is below the system, the negative pressure causes air to accumulate faster. This condition should be avoided if at all possible.

The effect of a few deficiencies often found in measuring devices has been given to illustrate the degree of error to be expected in making ordinary measurements under ordinary conditions. Other effects have not or cannot be stated in terms of percent error without an exact definition of the degree of fault or deterioration. The examples given should be sufficient to emphasize the importance of careful and exact installation practices as well as regular and prompt repair or rehabilitation of the devices after they have been installed.

11. Measuring Techniques Reducing Accuracy of Measurement

Regularly maintained equipment, properly installed in an ideal location, will still give inaccurate discharge measurements if the operator uses poor measuring techniques. Head measurement is very important. The techniques in use often are not compatible with the relationships between head and discharge known to exist. Operators should make sure that calibration curves or tables match devices being used both in size and kind.

(a) Faulty Head Measurement

Measurement of the head on a sharp-crested weir, a seemingly simple matter, can be difficult under all but ideal conditions. The head is the height of water above the blade edge or the bottom of a V-notch, measured at a point where the velocity head (or approach velocity) is negligible ([figure 5-6](#)). In practice, this point is located four to six times the measuring head upstream from the center of the weir blade. If the head is measured too far upstream, a head not related to the water surface profile at the weir can be measured. If the head is measured closer to the weir blade, some drawdown (caused by increased velocity near the weir) may occur and less than the true head will be measured. If the head is measured at the side of the approach channel, more or less than the true head may be measured depending on the geometry of the approach pool ([figures 5-2](#) and 5-13).



Figure 5-13 -- Cipoletti weir operating with good flow conditions in the approach pool.

Figure 5-13 shows a Cipoletti weir performing properly for the discharge shown. Flow is well distributed across the wide pool and shows no evidence of excessive turbulence. Accurate or "standard" discharges can be expected under these conditions. At larger discharges, the nonsymmetrical approach may produce undesirable conditions.

The principles described above also apply to head measurements on broad-crested weirs and flumes, meter gates, or any other device dependent on a head measurement for discharge determination.

Improper gage location, or an error in head measurement in a flume, can result in large discharge errors because of water surface curvature. Incorrect flume throat width dimensions and weir lengths can also produce errors. The relative ease of making accurate length measurements usually keeps these errors small. However, operators should check lengths in the field rather than rely on values stated or shown on drawings.

Readings obtained from stilling wells, whether visual or recorded, should be questioned unless the operator is certain that the well intake pipe is not partially or fully clogged with sediment or air pockets. Data from an overactive stilling well can also be misleading, particularly if long-period surges occur in the head pool. In fact, all head determinations should be checked to ensure that the reading is not part of a long period surge. A sufficient number of readings, about 10, should be taken at regular time intervals of about 15 seconds, and averaged to obtain the average head. More readings may be required if consecutive readings indicate that the pool is continuing to rise or fall. If this process takes too much time, the cause of the instability should be determined and eliminated.

Readings from gages or staffs which may have slipped or heaved should be avoided. Periodic rough checks can sometimes be made with a carpenter's level or square from a reference point on another structure. A still-ponded water level at the weir crest height is a valuable check on the staff gage zero.

Each operator should understand the desired measurement and then critically examine each operation to ensure that the correct measurement is being taken. The operator should try to find fault with every step in the head measurement process and attempt to improve techniques wherever possible.

(b) Infrequent Measurement

When a head or velocity measurement is taken, the operator must assume that the resulting discharge occurred only at the moment of the measurement. The operator cannot conclude that the same discharge occurred 5 minutes or even 5 seconds earlier. Therefore, accurate water deliveries can be ensured only if enough measurements are made to establish the fact that the discharge did or did not vary over the period that water was delivered.

In many systems, measurements are taken only once a day, or only when some physical change in supply or delivery has been made. Problems introduced by falling head, rising backwater, gate creep, or hunting are often ignored when computing a water delivery. The problem is not simple; many factors must be considered in determining the number of readings to be made per day or other unit of time. If the discharge in the supply system is increasing or decreasing, multiple readings will be required. If the rate of rise is uniform, the average of two readings, morning and night, would be better than one. Erratic rates of change will require frequent readings. A need for many readings may justify the use of a recording device.

When the discharge in the supply system remains constant, the water level or velocity reading may change because of a change in control or because checks have been placed in operation. Temporary changes in the main supply system discharge may occur; for example, because water, in effect, is being placed in storage as a result of the rising water level. Conversely, the discharge may temporarily increase in parts of the system if the operating level is being lowered. The changing water level may require more frequent head readings. If accurate, instantaneous recording of highly variable flows is required, then stilling wells may need larger connecting pipe diameters to reduce time lag. In some situations, weir pooling volumes need accounting.

Here again, the operator should try to visualize the effect of any change in discharge in the supply system, upstream or downstream from a measuring device, and attempt to get more than enough readings to accurately compute the quantity of water delivered.

(c) Use of Improper Measuring Device

Every water measuring device has unique limitations; thus, a single type cannot be used in all locations under all possible conditions. Therefore, several devices might be suitable for a given set of conditions, but none could be considered entirely satisfactory. If flow conditions change considerably for any reason because of modified operations, a formerly suitable device may become totally inadequate. A formerly marginally suitable device may become useless for a small change of operation needs. An incorrect device may have been selected in the first place, and no matter how much care the operator takes, accurate measurements cannot be obtained. The operator should call attention to such situations and attempt to have remedial measures taken. Chapter 4 gives guidance for selection.

For example, with sharp-crested weirs, accuracy cannot be expected if the head is appreciably less than 0.2 ft or greater than about one third of the weir blade length. Large measurement errors can be expected (departure from standard) if these limits are exceeded appreciably.

Large errors are introduced if a sharp-crested weir blade is submerged by backwater. Designing a device that is to be submerged throughout all or part of its flow range requires using a calibration related to a measuring head differential. Having a second or downstream measuring head station doubles the chance for wrong readings. Despite the appearance of handbook submergence discharge determination methods, discharge is related to small differences in measuring heads. Small imprecisions in water elevation measurement cause large errors. As submergence increases, the measuring head differentials decrease and approach values that are about the same magnitude as for minor variations of form and friction loss. Thus, corrections for large submergence are very inaccurate.

Propeller meter devices should not be permanently installed where weeds, moving debris, or sediment are apt to foul the meter or wear the bearings. Submerged devices, such as meter gates and other types of orifices, should not be used where a moving bedload can partly block the openings.

The flow conditions at a particular site must be analyzed. Only then can the measuring device be selected that can best cope with conditions to be encountered. The user of irrigation-type measuring devices should not expect accuracy to exceed about ± 2 percent, even for standard devices that have been properly selected, set, and maintained.

12. Bibliography

Bos, M.G., *Discharge Measurement Structures*, third revised edition, International Institute for Land Reclamation and Improvement, Publication No. 20, Wageningen, The Netherlands, 1989.

Peterka, A.J., *Hydraulic Design of Stilling Basins and Energy Dissipaters*, Engineering Monograph No. 25, United States Department of the Interior, Bureau of Reclamation, Denver, Colorado, 1983.

Schuster, J.S. (ed.), "Water Measurement Procedures-Irrigation Operator's Workshop," REC-OCE-70-38, United States Department of the Interior, Bureau of Reclamation, Denver, Colorado, 1970.

CHAPTER 6 - MEASURING AND RECORDING WATER STAGE OR HEAD

1. Introduction

The stage of a stream, canal, or lake is the height of the water surface above an established datum (Buchanan and Somers, 1965). The head in a water measurement structure or device can be defined similarly. The stage, or gage height, of the water is usually expressed in feet and hundredths of a foot. Records of stage are important in stream gaging because the rate of flow is plotted against stage in preparing discharge curves. After a curve has been established for a stable channel, rate of flow can be directly determined from stage reading. Reliability of the stage reading is, therefore, of great importance. Head measurements in all types of water measurement structures, including various flumes, weirs, and gates, are equally important. Records of gage height may be obtained from a series of systematic readings on nonrecording gages or from automatic water-stage recorders. Laser, satellite, microwave, and electronic systems can be used to transmit gage readings from either nonrecording or recording gages.

2. Datum of Gage

A convenient and meaningful elevation datum should be selected for the station. The operating datum for the station should be set below the water-stage elevation for zero flow. The operating datum can be referenced to mean sea level. The datum should be permanent for the expected life of the station and should be referenced to at least two or three other benchmarks that are independent of the gaging structure.

3. Measurement Method

Two basic philosophies can be used to determine stage or gage height—direct and indirect. Direct methods involve a measurement of the height from the liquid level to a datum line; an indirect method infers the stage level from some other characteristic, such as the head read by a pressure transducer.

4. Nonrecording Gages

Two general types of nonrecording gages are in use: (1) staff gages, on which readings of stage are made directly; and (2) chain, wire weight, float-type, and hook gages, with which measurements are made from fixed points.

Staff gages may be either vertical or inclined. The inclined type should be carefully graduated and accurately installed to ensure correct stage readings. Most permanent gages are enameled steel plates bolted in sections to the staff. This kind of staff gage is shown on [figure 8-4](#) in chapter 8. Care should be taken to install the gages solidly to prevent errors caused by changes in elevation of the supporting structure.

A chain gage is a substitute for the staff gage and consists of a horizontal scale and a chain that passes over a pulley to attach to a hanging weight (figure 6-1). Chain gages may be mounted on a bridge that spans (or any other structure that overhangs far enough) over the stream. Water stage is indicated by raising or lowering the weight until it just touches the water surface and reading the position of the chain index mark on the horizontal scale.

Chain gages are affected by settling of the structure that supports them, changes in load on the structure, temperature changes, and changes in length as the chain links wear. Wind may also introduce errors by not allowing the weight to remain in a vertical position.

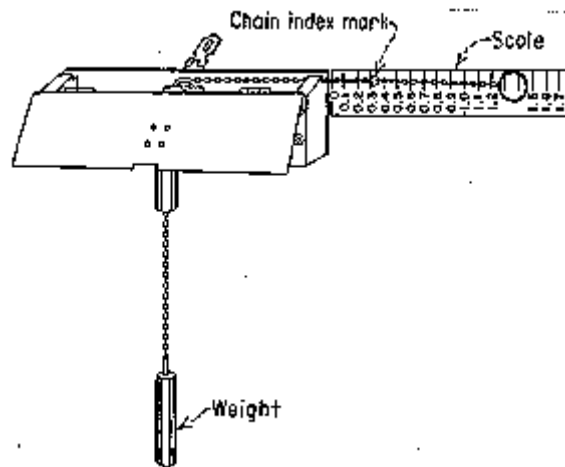


Figure 6-1 -- Chain gage.

The wire weight gage is a modification of the chain gage and uses a wire or small cable wound on a reel. The reel is graduated, or a counter is used to give readings to tenths and hundredths of a foot. A check bar of known elevation is often provided so that lowering the weight onto the bar will produce a reading on the counter or reel, which can be compared with the reference elevation. A wire weight gage is shown on figure 6-2.

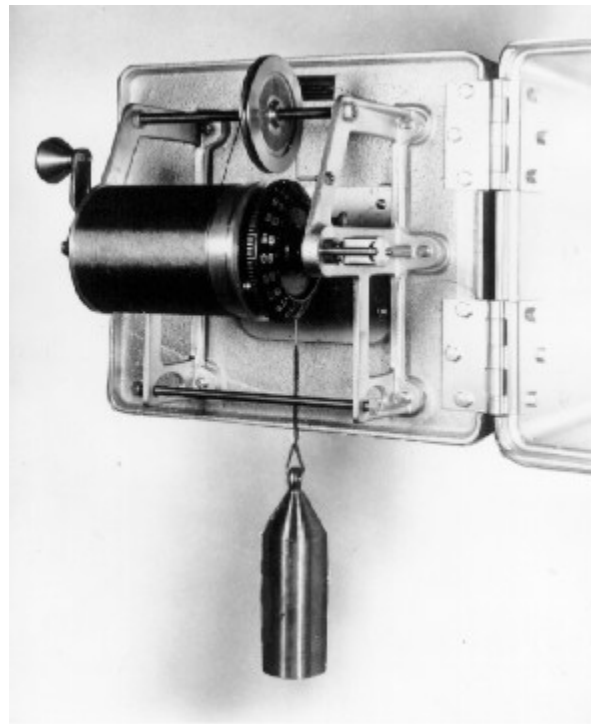


Figure 6-2 -- Nonrecording wire and weight-type gage.

5. Recording Gages

Water-stage recorders consist of a group of instruments that produce a record of water surface elevation with respect to time. The output can be analog (providing a graphical result) or digital (punched paper tape or stored or transmitted values). Important advantages of recorders over nonrecording staff gages are:

- (1) In streams having daily fluctuations, continuous records provide the most accurate means of determining the daily average gage height.
- (2) Maximum and minimum stage are recorded, and the time they occurred can be noted.
- (3) Records can be obtained at stations where observers are not always available.

(a) Analog-Graphical Recorders

In general, analog or graphical recorders consist of two main elements: a clock mechanism actuated by a spring, weight, or electric motor and a gage height element actuated by a float, cable or tape, and counterweight. Four basic types of recorders use these elements. Figure 6-3 shows a horizontal drum recorder, in which the clock positions the pen along the drum axis, and the gage height element rotates the drum. This recorder is also available with a vertical drum. Another type of recorder also has a vertical drum, but the time and height elements have been reversed so that the clock mechanism rotates the drum.

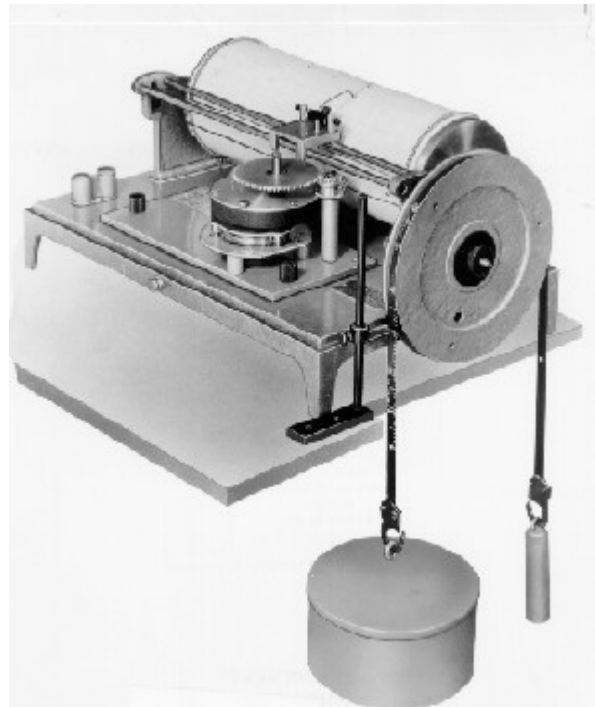


Figure 6-3 -- Horizontal drum water-stage recorder. The time element records parallel to the axis of the drum. (courtesy Leupold and Stevens Instruments, Inc.).

These types of recorders usually operate using 8-day, spring-driven clocks. Electrical drives could also be used if a reliable source were readily available. The stylus, usually either a capillary pen or a pencil of proper hardness, must be capable of operation for the full 8 days without attention. To accommodate various water-stage differentials, ratios of water-stage change to recorder-chart change are available from 1:1 to 10:1 and should be specified at the time the recorder is ordered. The standard width of recorder paper is 10 inches (in), and all recorders come equipped with metal covers.

The fourth type of graphic recorder is shown on figures 6-4 and 6-5. The time element, consisting of a compensated, balanced, weight-driven clock, drives two parallel rolls, one of which holds the supply paper. The paper unrolls from the supply roll at a uniform rate and with constant tension and is taken up on the receiving roll. Speed of travel may be adjusted from 0.3 to 9.6 in per day on any standard instrument, and other chart speeds are available on special order. The normal chart length is 75 feet (ft).

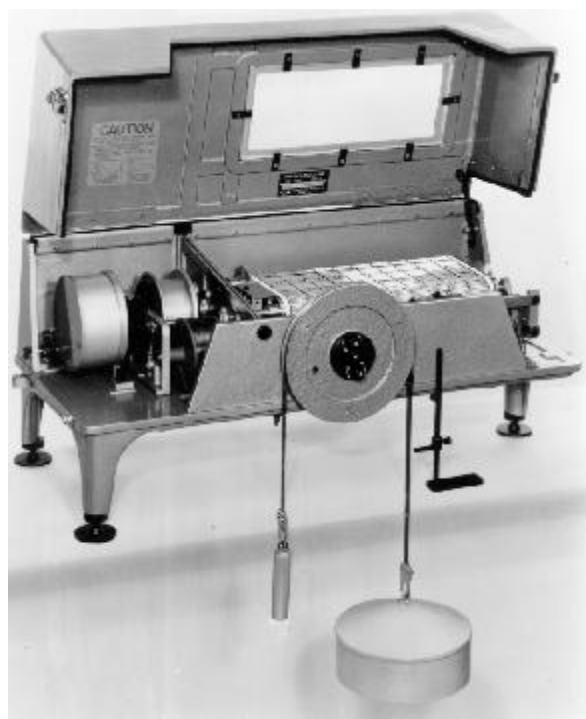


Figure 6-4 -- Continuous recording water-stage recorder with cover raised. The time element rotates the rolls, and the height element records parallel to the axis of the rolls. (courtesy Leupold and Stevens Instruments, Inc.).



Figure 6-5 -- Typical installation of a continuous water-stage recorder in a wooden shelter.

The float activates a pen stylus which moves parallel to the axis of the rolls so that 1 in of travel represents a change in water stage of 1 ft. The stylus is designed so that it can be accurately set for gage height. The ratio of water surface change to stylus travel can also be adjusted to accommodate small to large ranges of depth. The range of the recorder is limited only by the length of the float cable because the stylus reverses direction at the point of maximum deflection. Capacity of the ink reservoir is sufficient for the recorder to operate for 60 days or longer.

(b) Digital Recorders

Digital recorders used in water stage measurements usually include two types: punched-paper tape (figure 6-6) and analog-to-digital data loggers. Both types are electrically operated (usually by batteries) and record numbers either on the paper tape or in memory at selected time intervals.

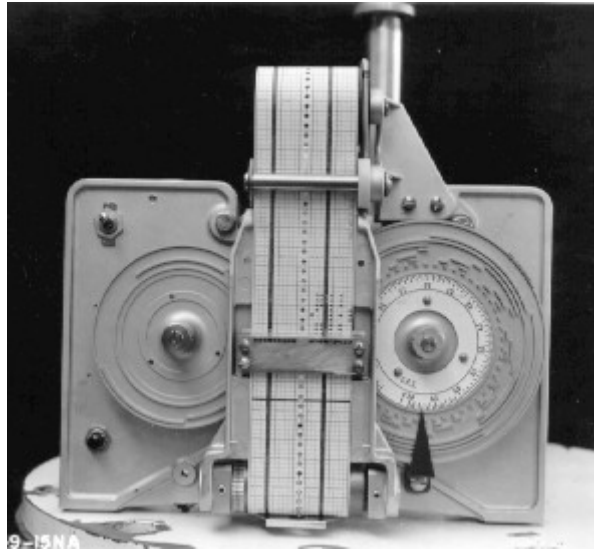


Figure 6-6 -- Digital recorder.

Water stage is transmitted to the punched-paper tape recorder, usually through shaft rotation on a float and pulley arrangement. Shaft rotation is converted by the recorder into coded punch-tape records (figure 6-7). The code consists of four groups of four punches each. In each group, the first punch represents "1"; the second, "2"; the third, "4"; and the fourth, "8." Thus, a combination of 1, 2, or 3 appropriate punches in a given group represents digits from 1 to 9. A blank (no punch) represents zero. Together, the four groups of punches represent all numbers from 0 to 9999.

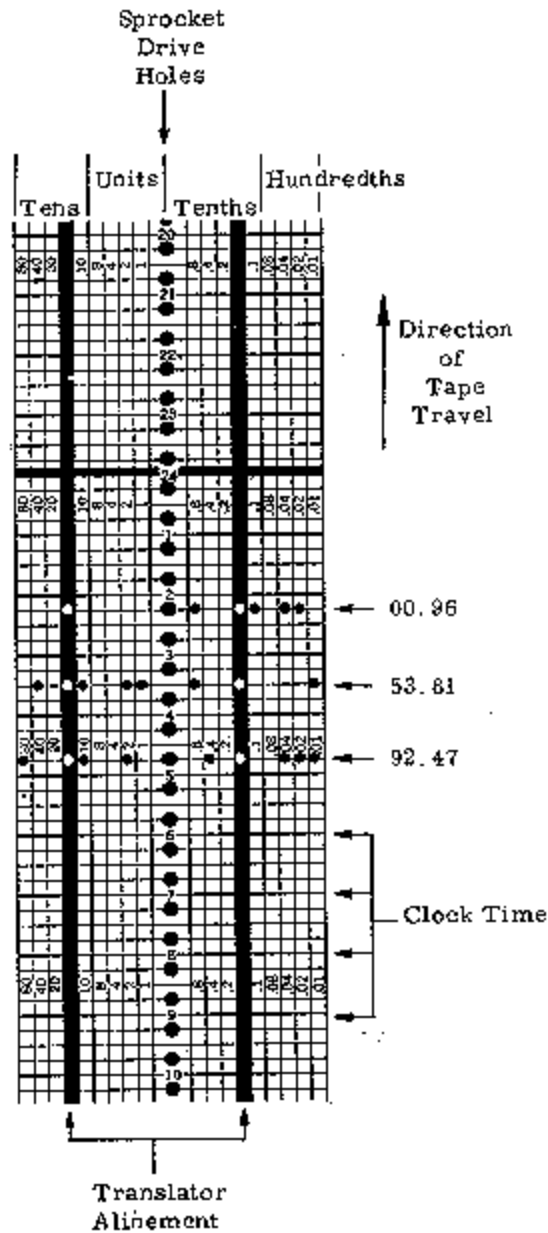


Figure 6-7 -- Digital recorder punched tape. (courtesy U.S. Geological Survey).

Coding is done by either one or two identical disks that have raised ridges on the faces. Figure 6-6 shows a digital recorder with only one disk, which produces 2-digit numbers ranging from 0 to 99. Two disks would be used if 3- or 4-digit numbers are required. The right-hand disk is connected directly to the input shaft, and the left-hand disk is driven from the first disk by a 100-to-1 worm-gear reducer. One-hundred revolutions of the input shaft and the first disk cause one revolution of the second disk. A paper tape is moved upward through the punch assembly in the center of the instrument. The punch block contains a row of 18 pins or punches-16 for information and 2 for feeding the tape. At the selected intervals of time, the punch assembly is pivoted on a shaft at the bottom, so the punch, paper, and pins are moved toward the disks. Those pins that strike raised ridges on the disks are forced through the paper, punching neat round holes. The pins that do not strike ridges do not punch holes. This record reflects the position of the disks, which is proportional to the water stage, all as a function of time.

The mechanically punched tape is still widely used at this time (1996) and is considered very practical for field use where temperature, moisture, and power conditions are widely variable. Electronic translators can convert punched tape records into suitable input for digital computers.

The most recent advances have been in the area of data loggers. This group of electronic instruments has evolved quickly over the last 10 years. Small, battery-operated, fully programmable units offer many features in addition to data recording (figure 6-8). Some type of transducer is required to sense the water stage with this type of recorder. Options range from a pressure transducer sensing water level in a stilling well to a pressure transducer on a bubbler system, to an angular transducer sensing shaft rotation on a float-driven system. In all cases, an analog (voltage or current) output is sensed, digitally recorded, and stored by the data logger. This type of system is perhaps best suited to the transmission of data via satellite or microwave, providing a central control location with current water stage information. Remote sites are very well suited to being powered by batteries which are charged through small solar cells. However, vandalism of the solar panels can be a problem because they must be exposed. Concealing solar panels in some way (such as in the top of a tree) can help.



Figure 6-8 -- Programmable battery operated recording unit.

6. Installation of Water-Stage Recorders

Important considerations in the installation of a water-stage recorder are the proper sizing and installation of a stilling or float well (if used) and the establishment of the reference datum for the site. The gage must be accessible at all times and substantially constructed for security and reliability. The recorder should be protected from the environment. The reference datum should be below the lowest stage of the stream or structure, and the instrument used to measure the stage must have the capability to cover the full range of water surface changes.

7. Stilling Well Considerations

Head readings on staff gages attached directly to the inside channel walls are often only estimates because of waves and turbulent fluctuations on the scale face. If the wall of a flume is relatively thin, the flume channel is connected directly by an orifice through the wall shared by the flume and stilling well to improve head reading. Separate or more remote wells are connected by pipes through thicker walls and embankments. Thus, the average water surface outside the well is translocated into the well, and the waves and fluctuations are dampened.

Polyvinyl chloride, polyethylene, and galvanized-iron pipes, sealed on the lower end with an opening in the side, make excellent wells.

Some older stilling wells were made from tongue-and-groove creosoted lumber and worked satisfactorily. Sewer pipe of suitable size with tightly sealed joints has also been used. On a flume, stilling wells are often formed of the same material as the flume. Because the primary purpose of the stilling well is to prevent oscillations of the float caused by surging water or wave action, the well must be firmly anchored to prevent movements that could introduce oscillations within the well.

Surges and wind waves of the outside water surface can be dampened by restricting the area of an inlet port through a relatively thin wall to about 1/1,000 of the inside horizontal cross-sectional area of the well. If the stilling well is served by a long connecting pipe, the diameter should be increased to produce the same effective dampening. Thin wall port diameters are about 1/30 the diameter of the wells, and connecting pipeline diameters are about 1/20 the diameter of the well. Thin wall port and connecting pipe diameters for different sized stilling wells for full dampening are tabulated below:

Table 6-1. Stilling well dimensions for full dampening		
Stilling well size	Thin through walls or short inlet pipes Diameter (in)	Connecting pipes 20 to 30 ft long diameter (in)
12-in diameter	1/2	1/2
16-in diameter	1/2	3/4
20-in diameter	5/8	3/4
24-in diameter	3/4	1
30-in diameter	1	1-1/2
36-in diameter	1-1/4	2
3- by 3-ft square	1-1/4	2
3- by 4-ft rectangular	1-1/2	3
4- by 5-ft rectangular	2	4

These table dimensions are used for connecting reservoirs and flumes where head remains relatively steady during reading and lag time is unimportant.

Frequently, for actively changing discharge systems or very remote wells, connecting pipes must be large enough to allow recorder floats to respond quickly and to follow the water level changes. Usually, this pipe diameter is about 1/10 the diameter of the stilling well. Also, the connecting pipe can be oversized, and a gate valve that has the same head loss for flow in both directions can be provided for throttling. The gate valve allows throttling to the required amount of dampening. However, the piping system from the inside wall of the flume channel to the inside wall of the well must have the same form and friction losses for pulses of flow in both directions. The gate valve must be located so that a distance of at least 20 pipe diameters exists on both sides of the valve. The gate valve should be centered.

If required, the gate valve could be opened fully for cleaning or to closely follow continually changing water level, or the valve could be throttled to prevent wide oscillation of ink pens. The pipe connection to the stilling well wall and flow channel wall should be perpendicular and carefully cut flush with the inside walls of the well and flume flow channel. Otherwise, the translocated water surface elevation in the well can deviate considerably from the actual mean elevation in the flume because of velocity impact and unbalanced head losses.

The size of the stilling well depends on the method used to measure the head. The diameter, if circular shaped, could range from a recommended minimum size of 4 in for hand-inserted dipsticks to 18 in to accommodate larger diameter floats. Wells may be much larger to provide access for cleaning or to make the reading of wall attached staff gages at sight angles at least as flat as 30 degrees. An overly steep sight angle will hinder accurate reading of water surface elevation on the staff gradations. It is recommended that well walls have a 2-in clearance from floats used with recorders. Weights should have adequate clearance from well walls.

A stilling well may need to house the float and recorder system or other surface detecting equipment. The wells may need to be tall enough to provide convenient access to recorders for reading, reference setting, and maintenance. The wells may need to be tall enough to keep counterbalance weights from interfering with float movement.

Before making a measurement, the wells should be flushed with fresh water to be sure they are free of sediment, foreign material, or blockages, which could cause erroneous head readings. Recording equipment should be checked and serviced regularly. Cross checks should be made between the staff gages, hook gages, plumb bobs, recorder values, and any other discharge indicators to expose system errors. Thus, even when using stilling wells, staff gages should still be used on the inside walls of flumes for cross checking. Further details on stilling wells can be found in [table 8.1](#) of chapter 8 (Bos et al., 1991; Brakensiek, 1979).

Figures 6-9 and 6-10 show designs of typical installations of a more permanent nature. Installation cost is an important consideration in the selection of a structure. Shelters often become attractive targets for firearms, so higher initial costs of permanent installations may be offset by savings in undamaged equipment and complete records. Figure 6-11 shows a current meter gaging station with cable, car, corrugated steel shelter house, and stilling well.



Figure 6-9 -- Stilling well and recorder house made of wood.

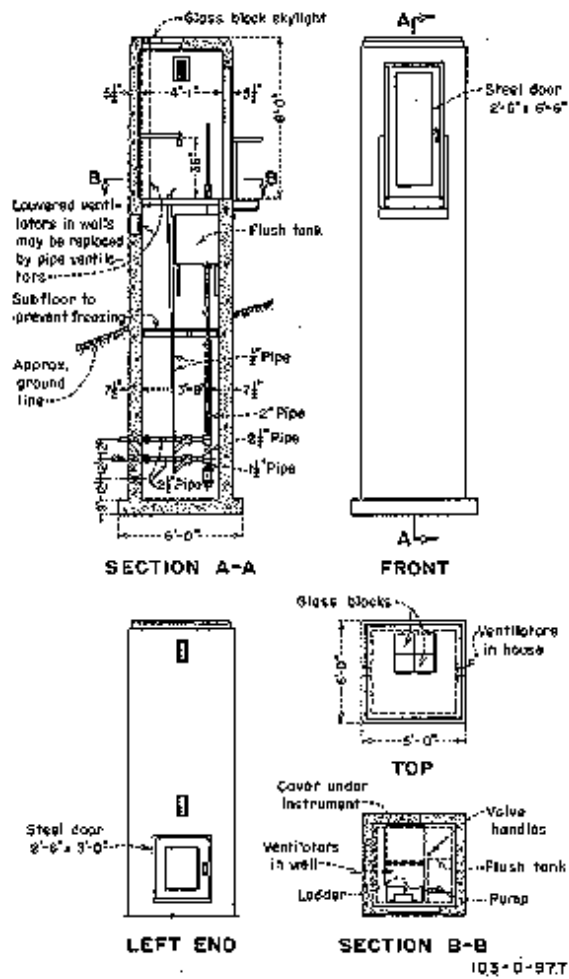


Figure 6-10 -- Plans for reinforced concrete recorder house and stilling well.



Figure 6-11 -- Current-meter gaging station with cable car, corrugated steel shelter house, and stilling well.

If a continuous record of water stage is required at a particular location, the cost of a concrete gage house and stilling well is usually justified. Figure 6-12 shows plans for a typical concrete structure used by the U.S. Geological Survey (Wahl et al., 1995). Considerable care must be used in construction to minimize settling or cracking of the concrete.

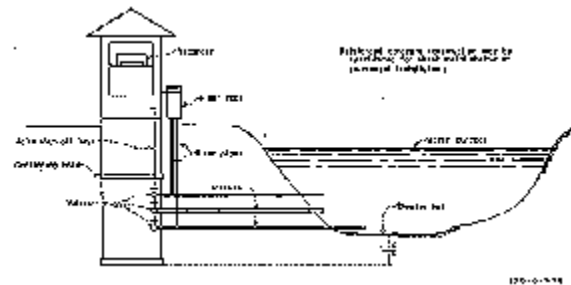


Figure 6-12 -- Plans for smooth and corrugated steel pipe recorder housing and stilling wells (sheet 1 of 2).

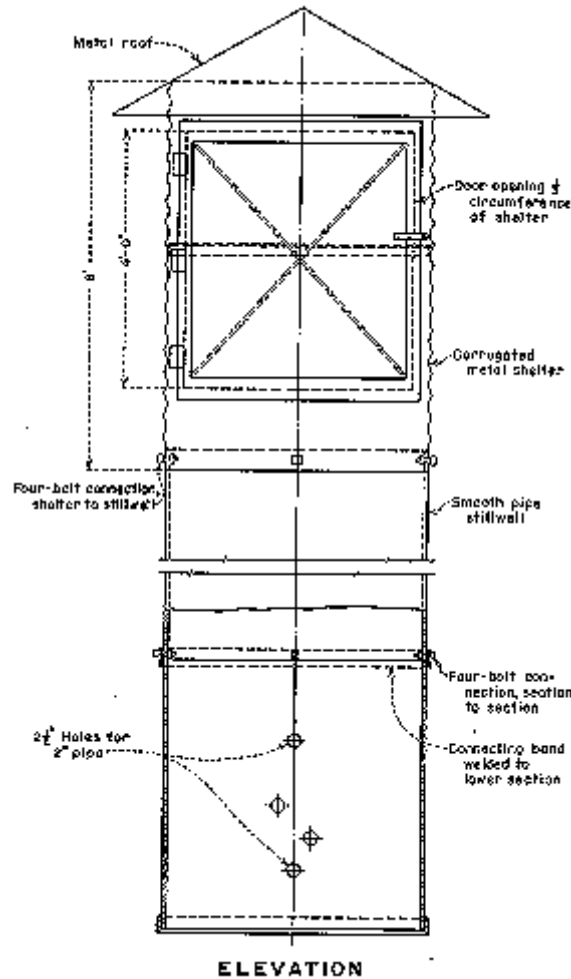


Figure 6-12 -- Plans for smooth and corrugated steel pipe recorder housing and stilling wells (sheet 2 of 2).

The intake pipes on most stilling wells require occasional cleaning, especially on streams and canals carrying sediment. A flushing tank and pump cannot be justified on any but permanent installations (figure 6-9). The tank is filled with a hand pump, and a sudden release of the tank water will usually flush out the intake piping. For tightly clogged pipes or temporary or semi-permanent stilling wells, a sewer rod or "snake" provides the most satisfactory means for cleaning. The use of plugged crosses instead of tees and elbows in the piping system allows for the easy insertion of the cleaning rods or "snakes."

8. Setting the Datum

Setting the zero or datum elevation is one of the most important tasks when setting up a gaging station in a stream, river, or on a measurement structure. Care must be taken to ensure that the datum is below the zero flow level and that it can be independently located from points outside of the gaging structure. Datums are typically set using surveying techniques, often relating the datum elevation to mean sea level. A staff gage is usually located nearby to verify that the gaging station is operating correctly. Periodic checks on the datum elevation should be performed to ensure that no movement or settling of the stilling well or structure has occurred.

Erroneous readings from a gaging station are many times directly related to the setting or shifting of the datum.

9. Operation, Maintenance, and Care of Water-Stage Recorders

Standard procedures for operation of water-stage recorders should include verifying correct operation of the type of recorder present, checking that water elevations inside and outside of the stilling well match, inspecting and cleaning the intake pipe to the stilling well, and verifying that clocks (if so equipped) are operating properly. Inspections at regular, short intervals are generally required to keep breaks in data at a minimum. Persons installing and servicing water-stage recorders should follow manufacturers' recommended instructions for that particular instrument. These instructions should be placed conspicuously inside the instrument case or shelter.

Recorder enclosures should be well ventilated to prevent excessive humidity from affecting operation. Moist air can be excluded from the recorder by a partition over the stilling well. Instrumentation for detecting and correcting errors caused by high humidity is available if necessary.

Condensation within the recorder cover and metal shelters can be alleviated by gluing or spraying a resistant coating (such as cork) inside of each. Silica gel can be used as a desiccator, but it must be replaced occasionally or the moisture must be removed from the gel by heating in an oven at 300 degrees Fahrenheit.

The well and shelter must be maintained in good condition, the intake pipes must be kept open, and the well must be protected from ice and drift. Freezing weather may require heating the well with an electric heater or a cluster of lights. A layer of low-freezing-point, environmentally safe oil in the float well equal to the greatest thickness of ice expected can also be effective. In the past, oils such as kerosene or fuel oil were used; however, because of the possibility of the oil spilling into the water supply, only nontoxic, environmentally safe oils should be considered for this use.

10. Bibliography

Bos, M.G., J.A. Replogle, and A.J. Clemmens, 1991, *Flow Measuring Flumes for Open Channel Systems*, John Wiley & Sons, 1984, and American Society of Agricultural Engineers, New York, 1991.

Brakensiek, D.L., H.B. Osborn, and W.R. Rawls (coordinators/ editors), *Field Manual for Research in Agricultural Hydrology*, Agricultural Handbook 224, U.S. Department of Agriculture, U.S. Government Printing Office, Washington, DC, 1979.

Buchanan, T.J., and W.P. Somers, "Stage Measurement at Gaging Stations," Chapter 10, Book 1, *Surface Water Techniques Series*, U.S. Geological Survey, Washington, DC, 1965.

Wahl, K.L., W.O. Thomas, Jr., and R.M. Hirsch, "The Stream-Gaging Program of the U.S. Geological Survey," Circular 1123, U.S. Geological Survey, Washington, DC, 1995.

CHAPTER 7 - WEIRS

1. Background

The weir is one of the oldest structures used to measure the flow of water in open channels. Several rating equations were developed for standard rectangular contracted weirs by different investigators. Generally, the data of each investigator are within ± 1.5 to ± 2.5 percent with respect to their individual equations, but comparisons of the various equations differ as much as several percent (King and Brater, 1976; Ackers et al., 1978).

In the past, user organizations selected an equation, called it standard, and specified construction requirements and limitations of use. However, Kindsvater and Carter (1959) developed an improved method for computing rates of flow through rectangular, thin-plate weirs. Their method also applies to fully side suppressed, partially contracted, and fully contracted rectangular weirs. Kulin and Compton (1975) discuss the method and equation for rating fully contracted V-notch weirs with any angle between 25 degrees and 100 degrees. This method also rates partially contracted 90-degree, V-notch weirs. Sections 6 and 7 give references and discuss these improved rating methods in more detail.

The Kindsvater approach accounts for velocity of approach effects and the accompanying variation of discharge coefficient caused by changes of effective width and head. This method is preferred for calibrating or rating rectangular and triangular weirs. Also, this method will correct for excess approach velocity in standard weirs. Thus, this newer approach will accurately recalibrate some of the older weirs that are no longer operating as standard, as well as some that never were standard.

The previous editions of this manual presented considerably less accurate methods to correct for velocity of approach, all of which assumed that all the correction was accountable as a head adjustment alone. The Kindsvater relationships clearly show the defect of this assumption. Velocity of approach affects the effective crest length and the effective contraction coefficient, as well as the effective measuring head, all of which are accounted for in the Kindsvater approach. Thus, the older methods for correcting for velocity of approach are not contained in this edition of the manual.

2. Definition of Weirs

A **measuring weir** is simply an overflow structure built perpendicular to an open channel axis to measure the rate of flow of water. Inspecting and checking the critical parts of weir structures for degradation and improper operation are easy.

A properly built and operated weir of a given shape has a unique depth of water at the measuring station in the upstream pool for each discharge. Thus, weirs can be rated with respect to an upstream head relative to the crest elevation versus discharge, and equations or tables which apply to the particular shape and size weir can be generated. The crest overflow shape governs how the discharge varies with head measurement.

3. Weir Nomenclature and Classification

The overflow section shape cut with a sharp upstream corner into a thin plate is the weir **notch**, sometimes called the **overflow section**. If the notch plate is mounted on the supporting bulkhead such that the water does not contact or cling to the downstream weir plate or supporting bulkhead, but springs clear, the weir is a **sharp-crested** or **thin-plate** weir.

A weir in the form of a relatively long raised channel control crest section is a **broad-crested** weir. The flow control section can have different shapes, such as triangular or circular. True broad-crested weir flow occurs when upstream head above the crest is between the limits of about $1/20$ and $1/2$ the crest length in the direction of flow. For example, a thick wall or a flat stoplog can act like a sharp-crested weir when the approach head is large enough that the flow springs from the upstream corner. If upstream head is small enough relative to the top profile length, the stoplog can act like a broad-crested weir. Wide, flat, triangular weirs exist that have wall sills with beveled corners. These **short-crested** weirs are in frequent use for hydrologic watershed research. Section 14(f) discusses these weirs.

Weirs are commonly named by the shape of their blade overflow opening shape (figure 7-1) for sharp-crested weirs or the flow control section shape for broad-crested weirs. Thus, weirs are partially classified as rectangular, trapezoidal, triangular, etc. In the case of sharp weirs, the triangular weir is also called a **V-notch** weir, and one kind of trapezoidal weir is the **Cipolletti** weir. In the case of rectangular or Cipolletti weirs, the bottom edge of the notch in the thin plate is the **crest**, and the side edges (which are vertical or flare up and outward) are the sides or ends (figure 7-1). The point of the triangle is the crest of a V-notch weir. The lowest elevation of the overflow opening of the sharp-crested weirs or the control channel of broad-crested weirs is the head measurement **zero reference** elevation.

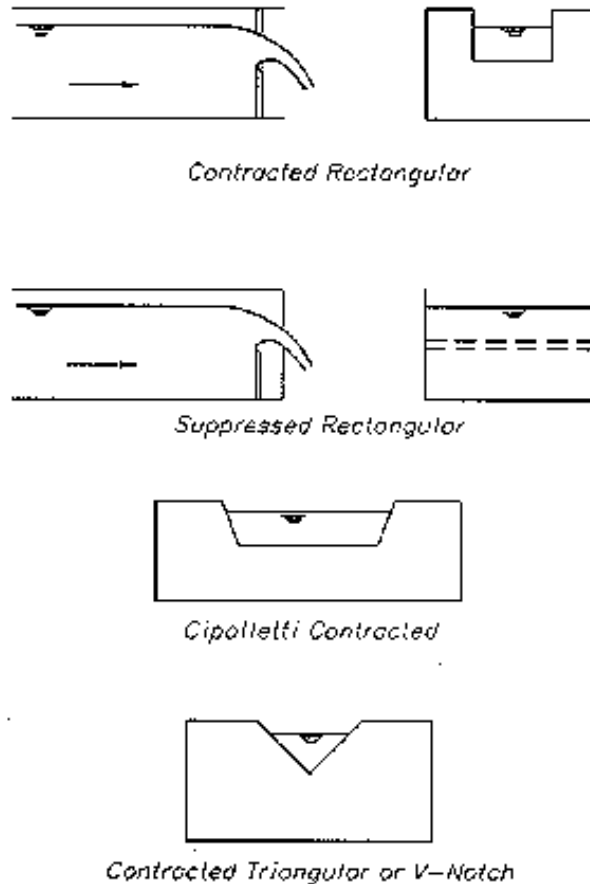


Figure 7-1 -- Different kinds of sharp-crested weirs.

When the distances from the sides of the weir notch to the sides of the weir pool are greater than two measurement heads, the water will flow relatively slowly along the bulkhead face toward the overflow opening. As the water from the sides of the channel nears the notch, it accelerates and has to turn to pass through the opening. This turning cannot occur instantaneously, so a curved flow path or **side contraction** results in which the water springs free to form a jet narrower than the overflow opening width.

Flow coming along the bottom of the weir pool and up a sufficiently high bulkhead and weir plate springs upward and forward in the curved, underside jet surface or **crest contraction**. The falling sheet of water springing from the weir plate is the **nappe**.

After passing the head measuring station or about a distance of two head measurements upstream from the overflow opening, the water surface drops more and more as flow approaches the crest. This continuing drop of water surface or **drawdown** results from the acceleration of the water as it approaches the weir. The drop in water surface between the measuring station and the notch is equal to the change of **velocity head**, or $V^2/2g$, between these stations as explained in section 7 in chapter 2.

The term **vertical contraction** includes both crest contraction and drawdown at the weir plate. When approach conditions allow full contractions at the ends and at the bottom, the weir is a **contracted weir**. For **full contraction**, the ends of the weir should not be closer to the sides and bottom of the approach channel than a specified distance.

Full side contractions on a thin-plate Cipolletti weir are shown on figure 7-2. If the specified distances are not met, then the weir is **partially contracted**.



Figure 7-2 -- Cipolletti weir operating with full contractions at the end and on the crest.

When sides of the flow channel act as the ends of a rectangular weir, no side contraction exists, and the nappe does not contract from the width of the channel. This type of weir is a **suppressed weir** and is shown on figures 7-1 and 7-3. To reproduce the full vertical rating, contraction of the suppressed weir that existed during its calibration requires full air ventilation under the nappe and the proper crest elevation.



Figure 7-3 -- Suppressed rectangular weir at a canal drop.

Velocity of approach is equal to the discharge divided by the flow section area at the head measuring station. Velocity of approach is important because it can change weir calibrations by effectively reducing the crest length and/or measuring head. In addition, a variable discharge coefficient results as increasing velocity changes the curvature of flow springing from the weir plates.

Free flow occurs when a thin-plate weir allows free access of air under the falling jet sheet or **nappe**. With free flow, head measurements at one upstream location determine discharge with knowledge of weir size and shape.

Downstream water rising above the weir crest elevation produces a **submerged weir** condition. When the downstream water surface is near or above the crest elevation of a sharp-crested weir, accuracy of measurement should not be expected. "Submerged flow correction methods" or "submerged calibrations" only produce estimates of discharge.

The use of a submerged weir as a water measurement device is not good practice and should only be done as a temporary, emergency procedure. Because of the large loss of accuracy, designing thin-plate weirs for submergence should be deliberately avoided. However, submergence may happen unexpectedly or may be temporarily necessary. In such cases, flow can be estimated using special techniques discussed in Skogerbe et al. (1967), but not on a long-term basis.

A **weir discharge measurement** consists of measuring depth or **head** relative to the crest at the proper upstream location in the weir pool, and then using a table or equation for the specific kind and size of weir to determine discharge. Commonly, a **staff gage**, described in chapter 6, having a graduated scale with the zero placed at the same elevation as the weir crest, measures head. Putting staff gages in stilling wells dampens wave disturbances when reading head. Using vernier hook point gages in stilling wells produces much greater accuracy than staff gages. These staff gages must be zero referenced to the weir crest elevation. Section 7 in chapter 8 provides more information regarding measuring head and related errors.

4. Different Sharp or Thin-Plate Weir Types

The types of traditional fully contracted weirs commonly used and considered standard for measuring irrigation water are:

- Rectangular weirs
- V-notch weirs from 25 degrees to 100 degrees
- Cipolletti (trapezoidal) weirs

Common partially contracted weirs are:

- Partially contracted rectangular weirs
- Partially contracted 90-degree V-notch weirs

Equations for weirs determine discharge values used to produce tables for field use. However, users and designers must pay due respect to specific limits such as calibration range, velocity of approach, setting requirements, dimension tolerances, and operating techniques. A few weir tables are extended by measured data outside of equation limits.

5. Conditions Needed for All Types of Sharp-Crested Weirs

Certain requirements are common to all sharp-crested weir measurement structures. Extensive experiments on weirs and long-term experience show that the following conditions are necessary for accurate measurement of flow (see also, Fig. 5-2):

- (a) The upstream face of the weir plates and bulkhead should be plumb, smooth, and normal to the axis of the channel.
- (b) The entire crest should be level for rectangular and trapezoidal shapes, and the bisector of V-notch angles should be plumb.

- (c) The edges of the weir opening should be located in one plane, and the corners should have proper specified angles.
- (d) The top thickness of the crest and side plates should be between 0.03 and 0.08 inch (in).
- (e) All weir plates should have the same thickness for the entire boundary of the overflow crest. If the plates are thicker than specified in condition (d), the plate edges shall be reduced to the required thickness by chamfering the downstream edge of the crest and sides to an angle of at least 45 degrees; 60 degrees is highly recommended for a V-notch to help prevent water from clinging to the downstream face of the weir.
- (f) The upstream edges of the weir opening plates must be straight and sharp. Edges of plates require machining or filing perpendicular to the upstream face to remove burrs or scratches and should not be smoothed off with abrasive cloth or paper. Avoid knife edges because they are a safety hazard and damage easily.
- (g) The bottom edge plates and fastener projection upstream should be located a distance of at least two measuring heads from the crest. If not, the plates must be inset flush with the upstream face of the supporting bulkhead, and the fasteners must be countersunk on the upstream pool side. Upstream faces of the plates must be free of grease and oil.
- (h) The overflow sheet or nappe should touch only the upstream faces of the crest and side plates.
- (i) Maximum downstream water surface level should be at least 0.2 foot (ft) below crest elevation. However, when measuring close to the crest, frequent observations are necessary to verify that the nappe is continually ventilated without waves periodically filling the under nappe cavity.
- (j) To prevent the nappe from clinging to the downstream face of the weir, the head measurement should be greater than 0.2 ft. Conditions (d), (e), and (f) also help to prevent clinging. If measurements must be made at heads approaching this value for substantial periods, operators must ensure the head measuring system has commensurate precision with respect to needed accuracy and must continually check for clinging.
- (k) The measurement of head on the weir is the difference in elevation between the crest and the water surface at a point located upstream from the weir a distance of at least four times the maximum head on the crest.
- (l) Keep the approach to the weir crest free of sediment deposits. All the approach flow conditions as discussed in section 17 of chapter 2 of this manual apply.

Additional requirements and limitations specific to different types of weirs follow.

6. Partially and Fully Contracted Rectangular Weirs

Kindsvater and Carter (1959) developed an improved method for calibration rating of rectangular thin-plate weirs. The method applies to both fully and partially contracted rectangular weirs. The method also rates the equivalent of a suppressed weir. The capability of rating partially contracted weirs provides design versatility, especially in selection of low crest heights to reduce head drop and side contraction needed to measure flow. Thus, these weirs can reduce head loss and conserve delivery head. These weirs have coefficients that vary with measuring head as well as geometry. The resulting calibrations are at least as accurate as the equations and tables for "standard" fully contracted weirs. Weir use and dimension limits are defined by the curves for determining the calibration ratings.

The basic equation for the Kindsvater-Carter method is:

$$Q = C_e L_e h_{1e}^{3/2} \quad (7-1)$$

where:

Q = discharge, cubic feet per second (ft^3/s)
 e = a subscript denoting "effective"
 C_e = effective coefficient of discharge, $\text{ft}^{1/2}/\text{s}$
 $L_e = L + k_b$
 $h_{1e} = h_1 + k_h$

In these relationships:

k_b = a correction factor to obtain effective weir length
 L = measured length of weir crest
 B = average width of approach channel, ft
 h_1 = head measured above the weir crest, ft
 k_h = a correction factor with a value of 0.003 ft

The factor k_b changes with different ratios of crest length, L , to average width of approach channel, B . Values of k_b for ratios of L/B from 0 to 1 are given on figure 7-4. The factor k_h is a constant value equal to 0.003 ft.

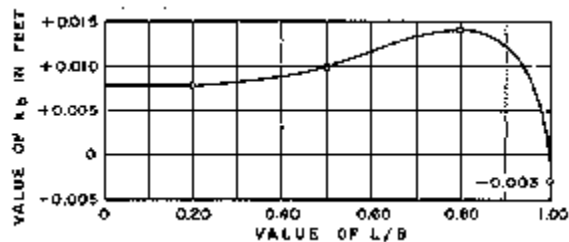


Figure 7-4 -- Value of width-adjustment factor from Georgia Institute of Technology tests (courtesy of American Civil Society of Engineers).

The effective coefficient of discharge, C_e , includes effects of relative depth and relative width of the approach channel. Thus, C_e is a function of h_1/p and L/B , and values of C_e may be obtained from the family of curves presented on figure 7-5. p is the vertical distance from the weir crest to the approach pool invert.

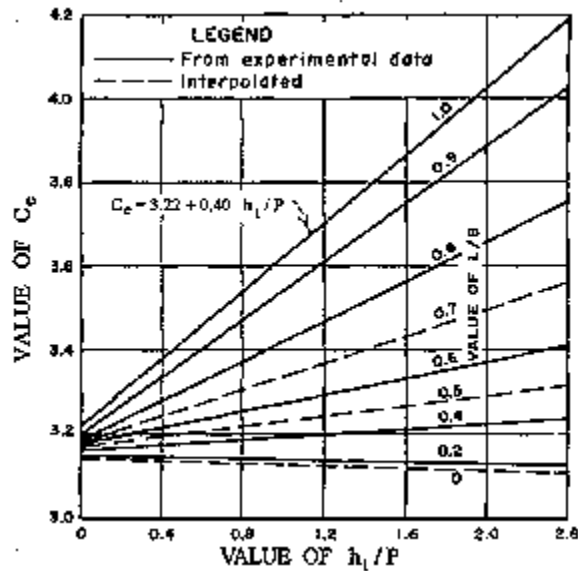


Figure 7-5 -- Effective coefficient of discharge, C_e , as a function of L/B and h_1/p , from Georgia Institute of Technology tests (courtesy of American Civil Society of Engineers).

The straight lines on figure 7-5 have the equation form:

$$C_e = C_1 (h_1/p) + C_2 \quad (7-2)$$

where:

- C_e = effective coefficient of discharge
- C_1 = equation coefficient
- h_1 = head on the weir (ft)
- p = height of crest above approach invert (ft)
- C_2 = equation constant

For convenience, the coefficients and constants for straight lines of each L/B on figure 7-5 are given in the following tabulation for interpolation:

Table 7-1. Coefficient and constants used in determining the effective coefficient of discharge for the Kindsvater-Carter method		
L/B	C_1	C_2
0.2	-0.0087	3.152
0.4	0.0317	3.164
0.5	0.0612	3.173
0.6	0.0995	3.178
0.7	0.1602	3.182
0.8	0.2376	3.189
0.9	0.3447	3.205
1.0	0.4000	3.220

The straightforward, comprehensive, and accurate Kindsvater-Carter method of determining discharges for rectangular weirs is well suited for discharge rating use. It is particularly useful for installations where full crest contractions or full end contractions are difficult to achieve.

Traditional rectangular weirs that do not meet crest height limits or that are using the older methods of correcting for velocity of approach should be recalibrated using the Kindsvater-Carter method. Weirs that fall out of the limits of the Kindsvater-Carter rating curves need replacement or field calibration by thorough current metering.

Limits on usage and dimensions are:

- The calibration relationships were developed with rectangular approach flow and head measurement sections for these weirs. For applications with other flow section shapes, the average width of the flow section for each h_1 is used as B to calculate discharges.
- The crest length, L , should be at least 6 in.
- The crest height, p , should be at least 4 in.
- Like all weirs used for head measurement, h_1 should be at least 0.2 ft .
- Values of h_1/p should be less than 2.4.
- All the requirements in section 5 apply.
- The downstream water surface elevation should be at least 2 in below the crest.
- All the approach flow conditions in chapter 2 apply .

7. V-Notch Weirs of Any Angle

The Kindsvater-Shen relationship can be used for fully contracted notches of any angle between 25 degrees and 100 degrees (Kulin and Compton, 1975). The equation which includes the angle θ as a variable is written as:

$$Q = 4.28 C_e \tan\left(\frac{\theta}{2}\right) h_{1e}^{5/2} \quad (7-3)$$

where:

Q = discharge over weir in ft^3/s

C_e = effective discharge coefficient

h_1 = head on the weir in ft

$h_{1e} = h_1 + k_h$

θ = angle of V-notch

The head correction factor, k_h , is a function of θ (figure 7-6a). However, for fully contracted traditional 90-degree V-notch weirs, equation 7-6 and the rating table discussed later produce comparable accuracy.

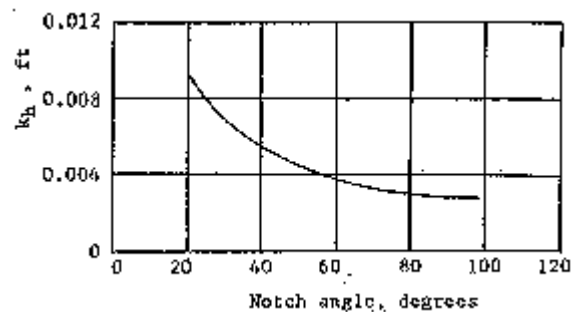


Figure 7-6a -- Head correction factor, k_h , for V-notches of any angle (courtesy of National Bureau of Standards, Kulin et al. [1975]).

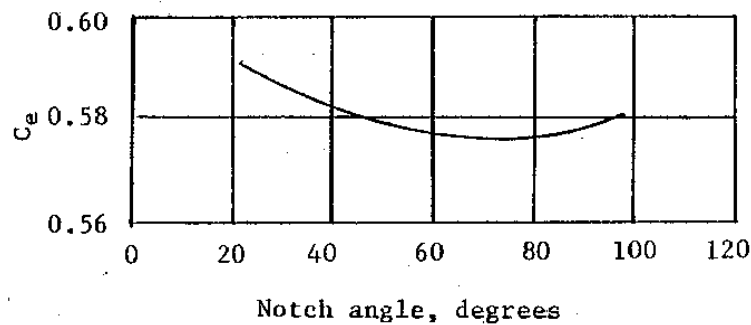


Figure 7-6b -- Effective coefficient, C_e , for fully contracted V-notches of any angle (courtesy of National Bureau of Standards, Kulin et al. [1975]).

For fully contracted V-notch weirs, the value of k_h is related to θ as given on figure 7-6a, and values of C_e are read from figure 7-6b. Partially contracted 90-degree V-notches only can be rated using figure 7-7 to obtain C_e values. The calibration relationships were developed with rectangular approach flow and head measurement sections for these weirs. For applications with other flow section shapes, the average width of the flow section for each h_1 is used as B to determine coefficients.

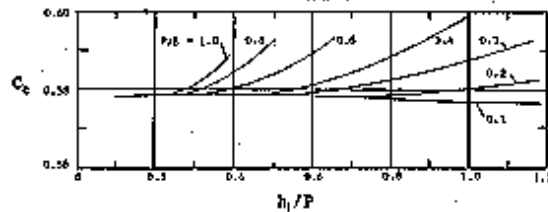


Figure 7-7 -- Effective coefficient, C_e , for partially contracted 90-degree V-notches (courtesy of National Bureau of Standards, Kulin et al. [1975]).

Bos (1989) and International Organization for Standardization (1983) explain and define limits basic to the use of these figures. Precautions and restrictions concerning the use of V-notch weirs are as follows:

- (a) V-notch weirs should not be designed beyond the range of the parameters plotted on figures 7-6 and 7-7. Only the 90-degree V-notch weir can be made partially contracted through the use of figure 7-7.
- (b) The water surface downstream from the weir should always remain at least 0.2 ft below the notch. Lower discharge readings should be rejected if the contraction is not springing underneath for the entire nappe length.
- (c) The measuring head should be greater than 0.2 ft because precision of head measurement error is large relative to smaller head depths, and the nappe may cling to the weir plate.
- (d) For the fully contracted V-notch, the maximum measuring head should be less than 1.25 ft.
- (e) For the partially contracted V-notch, the maximum head should be less than 2 ft.
- (f) For fully contracted V-notches, the h_1/B ratio should be equal to or less than 0.2.
- (g) For the partially contracted 90-degree notch, h_1/B should be equal to or less than 0.4.
- (h) The average width of the approach channel, B , should always be greater than 3 ft for the fully contracted V-notch.
- (i) For the partially contracted 90-degree V-notch, the approach channel width should be greater than 2 ft.
- (j) The V-notch of the weir should always be located at least 1.5 ft above the invert of the weir pool for fully contracted weirs.
- (k) Only the 90-degree V-notch can be partially contracted, but the point of the notch must be located at least 4 in from the channel invert.
- (l) All the requirements in section 5 apply.

(m) All the approach flow conditions in chapter 2 apply.

8. Some Traditional Standard Irrigation Weirs

In the past, user organizations selected specific equations from a choice of many, called them "standard," and specified requirements in construction and use to assure full contraction and nearly constant coefficients. Thus, equations and tables for "standard" weirs have strict limits and construction requirements, mainly in terms of the distance of the crest from the approach channel boundaries. In contrast, weir discharge calculated using Kindsvater methods will account for changes in velocity of approach caused by proximity of approach flow boundaries to crests. Thus, a weir designed with the Kindsvater methods can measure and deliver flow with less head loss than a similar "standard" weir mentioned above.

9. Standard Contracted Rectangular Weirs

The fully contracted rectangular weir ([figure 7-1](#)) is the most frequent standard weir used in irrigation. To be fully contracted, all overflow plate sides and ends must be located at least a distance of $2h_{1max}$ (two maximum measurement heads) from the approach flow boundaries. Head is measured at a distance of at least $4h_1$ from the weir.

(a) Discharge Equation for Standard Fully Contracted Rectangular Weirs

The Francis (1883) equation is convenient for weirs operating under favorable prescribed conditions. The Francis equation is:

$$Q = 3.33h_1^{3/2}(L - 0.2h_1) \quad (7-4)$$

where:

Q = discharge in ft^3/s neglecting velocity of approach

L = the length of weir in ft

h_1 = head on the weir in ft

The Francis equation has a constant discharge coefficient which facilitates computations without the use of tables. However, the coefficient does not remain constant for a ratio of head-to-crest length greater than one-third, and the actual discharge exceeds that given by the equation.

Francis' experiments were made on comparatively long weirs, most of them with a 10-ft crest and heads ranging from 0.4 ft to 1.6 ft. Thus, these equations apply particularly to such weirs.

The Bureau of Reclamation (Reclamation) experiments on 6in, 1ft, and 2-ft weirs on the Boise Project in Idaho show that the equation also applies fairly well to shorter crest lengths, provided the head of water on the weir is not greater than about one-third the length of the weir.

(b) Discharge of Standard Contracted Rectangular Weirs

Most of the discharges in tables [A7-2 through A7-5](#)¹ were calculated using equation 7-4.

¹ – The prefix "A" indicates that the tables(s) are located in the Appendix.

For most sizes of these weirs, the values of discharge in table [A7-2](#) end when the measurement head reaches one-third of the crest length, the limit of the equation. Reclamation, Boise Project, calibrated weirs to extend the head range of contracted rectangular weirs. Their calibrations are included in the table for the 6-in, 1-ft, and 2-ft crest lengths and are indicated by shaded entries in the tables.

(c) Limits of Standard Fully Contracted Rectangular Weir

Equation 7-4 should not be used beyond the maximum discharges shown in [table A7-2](#) or for measuring heads greater than one-third the crest lengths. All the requirements in section 5 apply. All the approach flow conditions in chapter 2 apply. The crest height, p , should be at least equal to $2h_{1max}$. The side contractions should also be located a distance of $2h_{1max}$ from the approach channel boundary.

Head is measured upstream at a distance of at least $4h_{1max}$ from the weir crest. Should any of these criteria be violated, discharge rating using the Kindsvater-Carter method is still possible.

10. Standard Suppressed Rectangular Weir

A standard suppressed rectangular weir has a horizontal crest that crosses the full channel width. The elevation of the crest is high enough to assure full bottom crest contraction of the nappe. The vertical sidewalls of the approach channel continue downstream past the weir plate, preventing side contraction or lateral expansion of the overflow jet.

Special care must be taken with suppressed weirs to secure proper aeration beneath the overflowing sheet at the crest. Aeration is usually accomplished by placing vents on both sides of the weir box under the nappe (figure 7-8).

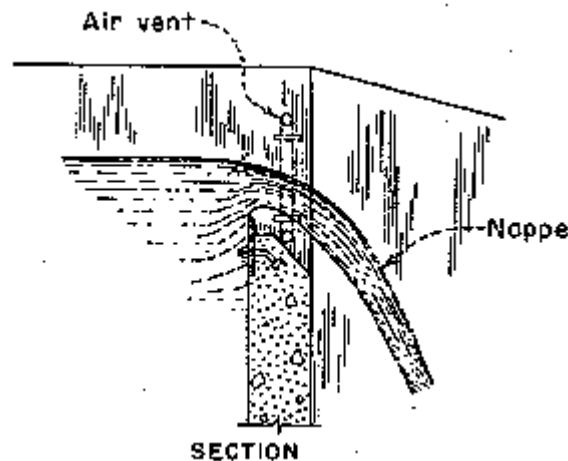


Figure 7-8 -- Section through suppressed weir with air vent in wall.

Other conditions for accuracy of measurement for this type of weir are identical to those of the contracted rectangular weir, except those relating to side contraction and the crest height. The crest height should be equal to at least $3h_{1max}$. A suppressed weir in a flume drop is illustrated on [figure 7-3](#).

(a) Equation for Standard Suppressed Rectangular Weirs With Full Bottom Contraction

The Francis equation for the standard suppressed rectangular weir ([figure 7-1](#)) is:

$$Q = 3.33 L h_1^{3/2} \quad (7-5)$$

The variables in this equation have the same significance as in the equations for contracted rectangular weirs discussed in section 9. Francis obtained the coefficient of discharge from the same general set of experiments as those stated for the contracted rectangular weir. No extensive tests have been made to determine the applicability of these equations to weirs less than 4 ft in length. Similar to the contracted rectangular weir, heads less than 0.2 ft do not give accurate flow readings because the nappe of water going over the crest may not spring free of the crest. Also, at smaller head depths, heads that are large, relative to precision of head measurement, cannot be measured. The equation should not be used to compute discharges for heads less than 0.2 ft or greater than one-third the crest length.

(b) Discharge of Standard Suppressed Rectangular Weirs

[Table A7-3](#) contains discharges in cubic feet per second for full bottom contracted suppressed rectangular weirs. These discharges were computed from the Francis equation for lengths and heads commonly used in measuring small quantities of irrigation water.

(c) Limits of Standard Suppressed Rectangular Weirs

Equation 7-5 must not be used beyond the maximum discharges shown in [table A7-3](#) or for measuring heads greater than one-third the crest lengths. All the requirements in section 5 apply. All the approach flow conditions in chapter 2 apply. The crest height, p , should be at least equal to $3h_{1max}$ (three maximum heads). Head is measured at an upstream distance of at least $4h_{1max}$ from the weir. The sidewalls must extend at least a distance of $0.3h_{1max}$ down-stream from the crest, and the overflow jet must be adequately ventilated to the atmosphere.

However, the Kindsvater-Carter method discussed in section 6 is ideally suited for use with suppressed rectangular weirs. This method provides the capability of using partially bottom contracted suppressed weirs and automatically corrects for velocity of approach. This method is recommended for general use and is discussed in section 6. This method provides the opportunity to conserve delivery head by using crest heights less than $3h_{1max}$, within limits.

11. Fully Contracted Standard 90-Degree V-Notch Weir

The triangular or V-notch, thin-plate weir is an accurate flow measuring device particularly suited for small flows.

(a) Traditional Equation for Standard 90-Degree Contracted V-Notch Weirs

The Cone equation is commonly used for 90degree V-notch weirs. This equation is reliable for small, fully contracted weirs generally encountered in measuring water for irrigation.

The Cone equation is:

$$Q = 2.49 h_1^{2.48} \quad (7-6)$$

where:

$$Q = \text{discharge over weir in ft}^3/\text{s}$$

$$h_1 = \text{head on the weir in ft}$$

(b) Discharge of 90-Degree Contracted V-Notch Weirs

[Table A7-4](#) contains discharges in cubic feet per second for the standard 90-degree, fully contracted V-notch weir ([figure 7-1](#)) from the Cone equation for a range of heads ordinarily used in measuring small flows. To be fully contracted, all the overflow plate edges and the point of the notch must be located at least a distance of $2h_{1max}$ from the approach flow boundaries.

(c) Limits of 90-Degree Contracted V-Notch Weirs

The crest of the weir consists of a thin plate beveled 45 degrees or greater from the vertical to produce an edge no thicker than 0.08 in. If heads will be frequently near the 0.2-ft lower limit, then the beveling should be 60 degrees. This weir operates as a fully contracted weir, and all conditions for accuracy stated for the standard contracted rectangular weir apply. To be fully contracted, all the overflow plate edges and the point of the notch must be located at least a distance of two measuring heads from the approach flow boundaries. The head measuring station is located a distance of at least four measuring heads upstream from the weir crest. This 90-degree V-notch weir should only be used for discharges between 0.05 and 4.25 ft³/s and should not be used consistently near the high end of this range because a 2-ft fully contracted rectangular weir will deliver the same flow at 40 percent less head for the same approach channel width. All the requirements of section 5 apply. All the approach flow conditions in chapter 2 apply.

The use of the Kindsvater-Shen method for rating V-notched weirs can considerably extend the limitations described above.

12. Cipolletti Weir

A standard Cipolletti weir is trapezoidal in shape. The crest and sides of the weir plate are placed far enough from the bottom and sides of the approach channel to produce full contraction. The sides incline outwardly at a slope of 1 horizontal to 4 vertical. A Cipolletti weir is shown on [figures 7-1](#) and 7-9.



Figure 7-9 -- Cipolletti weir with a well-type head-measuring station.

(a) Equation for Cipolletti Weirs

The Cipolletti weir is a contracted weir. However, its discharge calibration resembles that of a suppressed weir because the effects of side contractions are intentionally compensated for by sloping the sides of the weir plate outward. Thus, discharge calibrations are nearly equivalent to suppressed weirs of the same crest lengths.

The Cipolletti equation, neglecting velocity of approach, is:

$$Q = 3.367 L h_1^{3/2} \quad (7-7)$$

where:

L = length of weir crest in ft
 h_1 = head on weir crest in ft

The accuracy of measurements obtained by use of Cipolletti weirs and the above equation is considerably less than that obtainable with suppressed rectangular or V-notch weirs (Shen, 1959). The accuracy of the discharge coefficient is ± 5 percent.

(b) Discharge of Cipolletti Weirs

[Table A7-5](#) contains discharges in cubic feet per second for standard Cipolletti weirs neglecting velocity of approach, for heads and lengths of weirs generally used in measuring small quantities of irrigation water. For the 0.5-ft, 1ft, 2-ft, and 3-ft weirs, and heads greater than one-third the crest length, the discharges have been taken from experiments performed at the Boise Project. All other discharges were computed from the Cipolletti equation. The data in the table may be considered accurate to ± 5 percent for weirs of the above listed lengths. The same accuracy applies to weirs of other lengths which are listed on the table with heads not over one-third the crest length.

(c) Limits of Cipolletti Weirs

All conditions for accuracy stated for the standard contracted rectangular weir apply to the Cipolletti weir. The height of the weir crest above the bottom of the approach channel should be at least twice the maximum head over the crest, and the distances from the sides of the notch to the sides of the channel should also be at least twice the maximum head. This weir should not be used for heads less than about 0.2 ft or for heads greater than one-third the crest length unless calibrations exist beyond this range for specific size weirs. The head is measured at least a distance of four measuring heads upstream from the crest.

All the requirements in section 5 apply. All the approach flow conditions in chapter 2 apply.

13. Special Weirs

(a) Compound Weirs

Unusual situations may require special weirs. For example, a V-notch weir might easily handle the normal range of discharges at a structure; but occasionally, much larger flows would require a rectangular weir. A compound weir, consisting of a rectangular notch with a V-notch cut into the center of the crest, might be used in this situation. A weir of this type is shown on figure 7-10.



Figure 7-10 -- Compound weir with 90-degree notch and suppressed rectangular crest used by U.S. Forest Service.

The compound weir, as described, has a disadvantage. When the discharge begins to exceed the capacity of the V-notch, thin sheets of water will begin to pass over the wide horizontal crests. This overflow causes a discontinuity in the discharge curve (Bergmann, 1963). Therefore, the size and elevation of the V-notch should be selected so that discharge measurements in the transition range will be those of minimum importance.

Determining discharges over compound weirs has not been fully investigated either in the laboratory or in the field. However, an equation has been developed on the basis of limited laboratory tests on a 1-ft-deep, 90-degree V-notch cut into rectangular notches 2, 4, and 6 ft wide to produce horizontal extensions of $L=0$, $L=2$, and $L=4$ ft, respectively (Bergmann, 1963). The weirs were fully contracted, and heads up to 2.8 ft above the notch point were used. The equation is as follows:

$$Q = 3.9h_1^{1.72} - 1.5 + 3.3Lh_2^{1.5} \quad (7-8)$$

where:

Q = discharge in ft^3/s

h_1 = head above the point of the V-notch in ft

L = combined length of the horizontal portions of the weir in ft

h_2 = head above the horizontal crest in ft

When h_1 is 1 ft or less, the flow is confined to only the V-notch portion of the weir, and the standard V-notch weir equation 7-6 is used.

Further testing is needed to confirm this equation before it is used for weirs beyond the sizes for which it was developed.

(b) Short Weir Box Turnouts

A simple and inexpensive irrigation turnout structure regulates rate of flow and provides a relatively quiet headwater pool in a short approach distance from canal pipe outlets into weir boxes. These measurement structures overcome defects in approach conditions not accepted by standard weir pools by using a combination of baffles and a shelf type gage stilling basin. This concept was first developed on the Yakima Project in Washington using Cipolletti weirs. One of the structures used for discharges up to about $1.5 \text{ ft}^3/\text{s}$ is shown on figure 7-11. This weir box was used to measure flows where the head differences between the canal water surface and the weir pool surface were as much as 4 ft. Discharges were determined by using the standard Cipolletti weir calibration in [table A7-5](#).



Figure 7-11 -- Weir box turnout with Cipolletti weir.

Simmons and Case (1954) and Palde (1972) studied this concept further to improve approach flow velocity distribution, still the water surface at the gages, and increase discharge measuring capacity, accuracy, and head differential between the supply canal head elevation and weir pool. To achieve narrower box widths, suppressed rectangular weirs were installed for full size laboratory tests. These tests developed system arrangements, box and weir dimensions, and stilling baffle arrangements (figures 7-12c and 7-13) and calibrations for discharges up to $12 \text{ ft}^3/\text{s}$ and for canal and weir pool head differences up to 6 ft. Suppressed rectangular weirs 3 and 4 ft long were used rather than Cipolletti weirs to simplify the structure and increase capacity.

To meet three different conditions likely to be encountered in the field, the three designs for 5.0-ft³/s maximum measuring capacity shown on figure 7-12 were prepared.

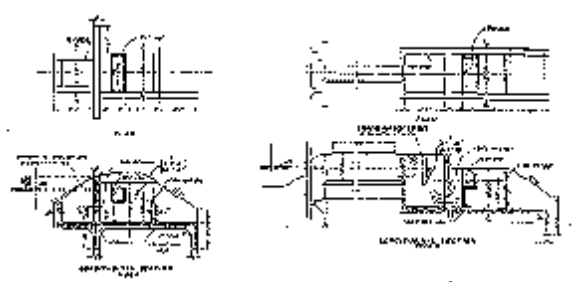
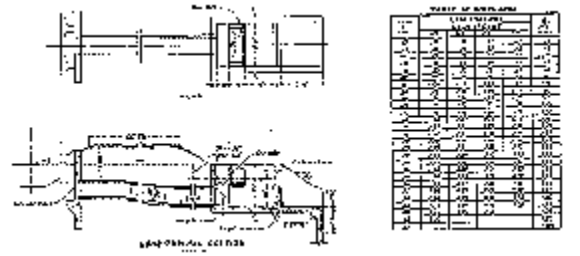


Figure 7-12a -- Standard designs for 5.0-ft³/s weir box turnout (sheet 1 of 3).



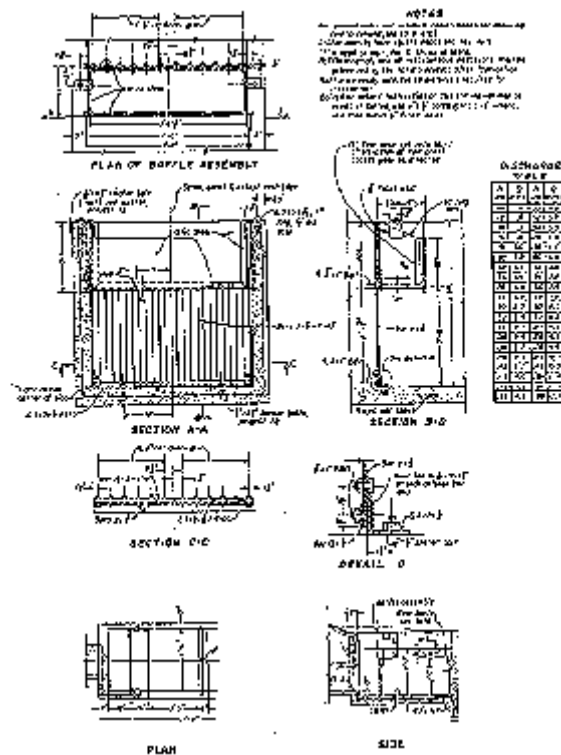


Figure 7-13 -- Baffle arrangement and rating table for 12-ft³/s weir box turnout.

The type 1 turnout weir box (figure 7-12a) is placed immediately adjacent to the supply canal with the turnout inlet recessed into the side of the canal. The type 2 turnout (figure 7-12a) is placed farther from the canal. Maximum discharge for turnout types 1 and 2 is 5.0 ft³/s with a maximum head drop between the canal water surface and the weir pool surface of 3.0 ft. The type 3 (figure 7-12b) turnout is designed for 5.0 ft³/s with a head drop of up to 6.0 ft. Instead of having the square bottom gate at the weir pool headwall, the gate is moved to the canal pipeline inlet.

Discharges through types 1 and 2 weir box turnouts are determined by measuring the weir pool head, h_1 , on the weir gage provided just above the baffles and wave suppressor, measuring the head drop, Y , using the weir gages both upstream and downstream from the gate, and using the table of discharge on figure 7-12b. Both weir gages should be set at the same elevation. Discharges through type 3 turnouts are determined by the single measurement of weir pool head, h_1 , and the table of discharge on figure 7-12b, depending on maximum design discharge measurement capacity.

The baffle arrangement and rating table for the 12-ft³/s maximum capacity weir box developed by Palde (1972), shown on figure 7-13, incorporates a suppressed weir. This weir box is installed in gate, pipe, and box configuration similar to the smaller discharge capacity weir box in the type 3 turnout using the dimensions and baffle arrangement shown on figure 7-12b, which also shows the calibration chart.

All four designs are arranged to permit easy construction as in-place structures or as precast units. All use reinforced concrete for the main box and headwalls and use separate, easily replaced, wooden or metal baffle assemblies in the weir pool.

A space is left open at the upstream face of the baffle so any accumulations of weeds and debris can be removed. Design and construction details for the 5- and 12-ft³/s weir boxes are given in Aisenbrey et al. (1978).

(c) Broad-Crested Weirs

A broad-crested weir is a raised overflow crest, commonly a flat horizontal block. However, a variety of crest shapes can be used to establish flow control in boundaries that are horizontal in the direction of flow. Broad-crested weirs often have special approach transitions ahead of and up to the crest surface, such as nose treatments like ramps and rounded corners. Crest length in the direction of flow is generally long enough, relative to the measuring head, to make the effect of flow curvature insignificant and short enough to prevent friction from controlling depths. These weirs can be computer calibrated when flow curvature is insignificant.

Broad-crested weirs are about as accurate as sharp thin-plate

weirs and also have some advantages, such as:

- Broad-crested weirs can be computer calibrated.
- A broad-crested weir could be considered if rusting, impact, abrasion, etc., might cause maintenance problems with a flat-plate weir.
- Specially shaped weirs can be designed to fit more complicated channel cross sections better, and the shape control section can be selected to provide special discharge ranging and variation needs with respect to head.
- Some forms of broad-crested weirs pass floating debris and sediment better than sharp thin-plate weirs, especially those with round nose or ramp approach transitions.
- Submergence does not affect broad-crested weirs up to about 80 percent with a vertical downstream drop and up to about 90 percent with sloped downstream transitions.

No clear-cut classification distinction or hydraulic difference exists between broad-crested weirs and long-throated flumes. Computer calibrations of broad-crested weirs use the principles and theories that are used for long-throated flumes. Thus, broad-crested weirs such as flat crests across trapezoidal and circular flow channels are covered in chapter 8.

(d) Movable Weirs and Adjustable Weirs

Movable weirs are weir assemblies mounted in metal or timber frames that can be moved from one structure to another. The frames fit freely into slots provided in the structures and are not fastened in place. Adjustable weir assemblies are mounted in metal frames permanently fastened to the structures. The weir blades in both the movable and the fixed frames can be raised or lowered to the desired elevations, usually by threaded stems with handwheels.

An adjustable weir used at a fixed frame location is shown on figure 7-14. A sufficiently large pool must be provided upstream from the weir to slow and quiet the flow before it reaches and overflows the weir blade. A fixed head gage is not recommended for flow measurement if the weir is to be moved up or down because the gage zero will not coincide with the weir crest elevation.



Figure 7-14 -- Adjustable Cipolletti weir in a division box.

A form of a movable crest broad-crested weir is discussed in Bos (1984) and Bos et al. (1991). This publication also shows how movable weirs can be arranged to provide shutoff and sediment sluicing provided enough channel drop is available.

(e) Flow Measurement Using an Overshot Gate

Overshot gates (figure 7-15), or leaf gates as they are sometimes called, are increasingly used for controlling water levels in open channels. This application is used partly because of the ability of the gates to handle flow surges with limited depth changes and the ease with which operators can understand their hydraulic behavior. With an overshot gate, a 6-in drop in the gate height corresponds closely to a 6-in drop in upstream water level. The main purpose of most main canal control gates is to maintain a constant water depth for turnouts located upstream. Thus, the turnouts will deliver water at nearly constant flow rates regardless of the flow rate in the main canal. If the water level in a main canal is constant, then turnout controls can be either weirs or orifice-based gates, such as sluice or radial gates. Generally, weirs are able to control main canal water surfaces more closely than orifice gates because the water level upstream varies with the three-halves power of the head over the weir compared to the one-half power for orifices.

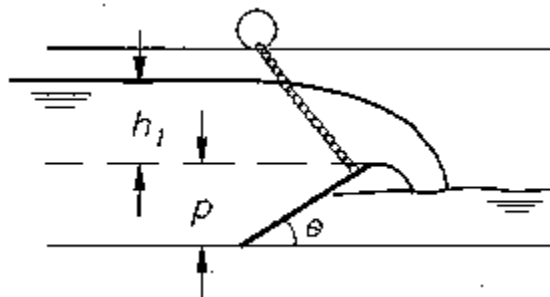


Figure 7-15 -- Sectional view of an overshot gate.

Although water level control is useful, operators also need to know the flow rate at each gate to better operate systems. Wahlin and Replogle (1994) further developed the Kindsvater and Carter (1959) calibration approach for a sloping leaf gate as a weir by modifying equation 7-1 with a gate angle correction coefficient, C_a , as follows:

$$Q = C_a C_e L_e h_e^{1.5} \quad (7-9)$$

where:

C_a = correction factor for angle of the gate

C_e = effective discharge coefficient for a vertical weir from [figure 7-5](#) or equation 7-2

L_e = effective crest length

h_e = effective measurement head

An empirical plot (figure 7-16) for C_a was determined from laboratory tests. For values of h_1/p less than 1.0 and for gate angles between 16.2 degrees and 63.4 degrees, the relationship for C_a is:

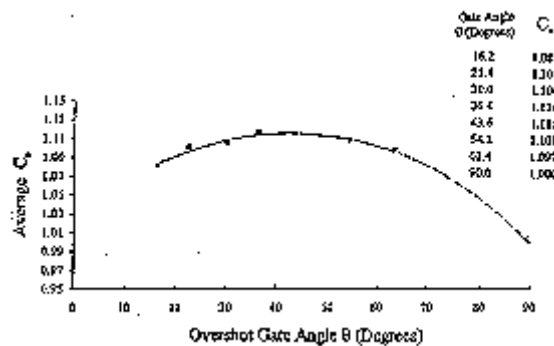


Figure 7-16 -- Correction factor, C_a , versus gate leaf angle, θ , for use in equation 7-9.

The angle, θ , is measured in the direction of the flow between the channel invert and the underside of the gate leaf in degrees.

$$C_a = 1.0333 + 0.003848\theta - 0.000045\theta^2 \quad (7-10)$$

These equations can determine the flow rate in the field of a properly ventilated free-flow leaf gate to within about 6.4 percent. These equations were tested against hydraulic laboratory modeling and field data. Eventually, with further testing, these authors expect to verify that their derived submergence functions will provide submerged flow calibrations to within about 10 percent. This accuracy estimation for submerged flow rate does not include errors associated with head measurement.

An example computation of free overshot discharge follows.

For a leaf gate that is 6.5 ft wide and 9.75 ft long, sloping at 40 degrees, mounted with the hinge point about 3 in above the invert, and a measurement head, h_1 , of 3.25 ft, calculate the free flow discharge.

The overfall edge of a leaf gate is in a region of no side contraction; therefore, the effective discharge coefficient can be calculated assuming no side contractions of the weir. Thus, [figure 7-7](#) or equation 7-2 with a C_1 of 0.40 and C_2 of 3.22 are used to calculate a value for the effective discharge coefficient, C_e , as 3.42 at h_1/p of 0.5.

Because no effects caused by side contractions were assumed, a value of -0.003 ft is assigned to K_b ([figure 7-4](#)). Kindsvater and Carter (1959) also recommend that a constant value of 0.003 ft be assigned to K_h regardless of the flow rate or gate height. Thus, L_e is 6.497 ft, and h_e is 3.253 ft.

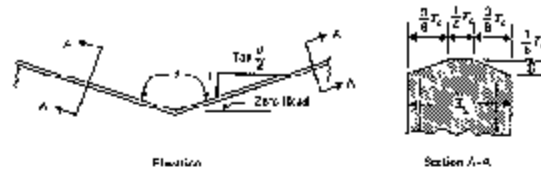
Because h_1/p is less than 1.00, and the gate angle is between 16.2 and 63.4 degrees, equation 7-8 can be used to determine that C_a is 1.115. Then, equation 7-7 is used to calculate discharge as below:

$$Q = (1.115)(3.42)(6.497)(3.253)^{1.5} \quad (7-0)$$

$$Q = 145.3 \text{ ft}^3/\text{s}$$

(f) Short-Crested Triangular Weirs

The Soil Conservation Service, now the Natural Resources Conservation Service, (Brakensiek et al., 1979) (U.S. Department of Agriculture, 1962) developed a triangular short-crested weir (referred to by some investigators as a triangular broad-crested weir) in the 1930's. The short-crested triangular design was adopted to provide a precalibrated meter installation that is economical, durable, and accurate over a wide flow range. The weirs are typically constructed entirely of reinforced concrete. The standard dimensions of the weir crest are given on [figure 7-17](#). Triangular weirs with crest slopes of 2 to 1, 3 to 1, and 5 to 1 are standard. A concrete apron is recommended downstream from the weir for a distance of two measuring heads to prevent erosion. Water stage is measured relative to the weir V-notch at a location 10 ft upstream from the centerline of the crest profile. The U.S. Natural Resources Conservation Service recommends the channel upstream from the weir be nearly straight and level for 50 ft. The weir notch must be located a minimum of 0.5 ft above the upstream channel bed. Deposition of material immediately upstream from the notch will cause flow measurement inaccuracies that are greatest at low measuring heads. The side slope of the triangular weir should be selected based on natural streambank topography. The weir must provide sufficient upstream ponding such that velocity head at the stage measurement station can be neglected for the desired accuracy. The discharge equation for a short-crested triangular weir is given on [figure 7-17](#).



$$Q = (C_0 + C_1 \text{Log}_{10} \frac{h}{T_0}) \sqrt{g} \tan \frac{\alpha}{2} \left(h + \alpha \frac{T_0}{20} \right)^{2.5}$$

$$\alpha = 1.33$$

v = average velocity in cross section 10 feet (3.048 m) upstream from center of crest

h = head (water surface elevation - zero head) 10 feet (3.048 m) upstream from center of crest

T_0 = crest thickness (16 in or 0.4064 m)

$T_0 \frac{h}{2}$	Range $\frac{h}{T_0}$	C_0	C_1
2	0.750 - 1.627	0.4708	0.06793
2	1.628 - 3.716	0.4906	0.01633
2	3.717 - 4.500	0.5142	-0.02450
3	0.750 - 2.329	0.4734	0.07075
3	2.330 - 3.755	0.4925	0.02092
3	3.756 - 4.500	0.5117	-0.01338
6	0.750 - 3.498	0.4766	0.07910
6	3.499 - 3.750	0.4976	0.01017
6	3.770 - 4.500	0.5089	-0.12692

Figure 7-17 -- Discharge equation for short-crested triangular weir (SCS Agriculture Handbook No. 244).

14. Velocity of Approach Corrections

If the traditional standard weirs need correction for excessive velocity of approach, then their limits, as expressed in the previous sections, have been exceeded. Velocity cannot be effectively corrected by adjusting head alone as done with older procedures. Recognizing this limitation is probably the reason for the development of the Kindsvater equations and methods, which account for velocity of approach caused by allowing partial contraction. Thus, Kindsvater methods will directly recalibrate most rectangular and triangular weirs with excess approach velocity. Correcting a Cipolletti weir reading is more difficult, and $(1/4)h_1$ must be added to the crest length to approximate a rectangular overflow opening. Then, the Kindsvater-Carter relationship is used to calculate discharge for both the fully contracted discharge case and the partially contracted case, causing the excess velocity of approach to determine the correction discharge ratio to apply to the Cipolletti table or equation value for discharge.

15. Weir Submergence

Accurate measurements of submerged sharp-crested weir discharges cannot be made because of the spread of measured data when determining correction factors for drowned or submerged weirs. Skogerboe et al. (1967) show plots of correction factor curves for several weirs with actual data points plotted around them. The range of data spread of submergence corrected discharge is "15 percent. Besides complicated hydraulics, submerged weirs also have the problem of precision of head reading relative to head measurement. Despite the form of the correction procedures, discharge is actually based on the difference of two heads.

These differential heads are small relative to the ability to measure head precisely. Therefore, submergence correction procedures should be only a temporary emergency procedure to provide estimates. The need for submergence correction should be eliminated directly by maintenance and cleaning of weeds, sediment, and other debris from the downstream channel, changing system operations, raising the crest, or installing another kind of measuring device since correction estimates are only within ± 15 percent.

Flow cannot be estimated for submerged partially contracted Kindsvater-Carter and Kindsvater-Shen calibrated weirs discussed in sections 6 and 7.

16. Weir Selection

If, after applying the concepts in chapter 4, the selection of a weir is indicated, discharge capacity and range should be considered next. Each weir has characteristics suited for particular operating conditions.

To conserve delivery head and reduce head loss, the rectangular and wide V-notch weirs rated by Kindsvater methods should be selected. These weirs provide the capability to use shorter heights from the approach channel invert to the crest. However, the downstream water surface should be sufficiently below the crest to prevent the nappe from clinging to the blade and to provide proper ventilation. If higher head through pipe outlets must be handled, then the short weir box can be used to reduce concentrated velocities and measure the flow.

For higher accuracy, a rectangular weir or triangular weirs down to a 20-degree V-notch weir should be used. Because the V-notch weir has no horizontal crest length, the head required for a small flow through it is greater than that required with the other weir types. This greater head is an advantage because nappes of smaller discharges will spring free of the crest. Nappe clinging to the crest of any type of weir makes measurement inaccurate. Although sharp-crested Cipolletti and rectangular weirs of 6-in crest length are sometimes used for measuring small flows, they are not as accurate or as sensitive as the V-notch weir for such flows and are not recommended where the V-notch weir can be used.

Cipolletti weirs have modified end contractions and have not been investigated experimentally as thoroughly as the rectangular and V-notch weirs. However, they have been usefully adopted by some water districts.

The range of flows to be measured by a weir usually can be estimated in advance. With this range in mind, other factors should be considered in selecting type and size of weir. If regulation is needed, then movable weir crests, including the overshot weir discussed in section 4, can be used.

The weir should be sized to prevent measuring at heads less than 0.2 ft to prevent surface tension effect on discharge and to keep the nappe from clinging to the crest. Also, at smaller depths, gage readings accurate enough to calculate reliable flow quantities are difficult to obtain.

Designing a weir for head as high as the allowable one-third of the crest length is not necessarily a good practice because the higher head may require a larger stilling basin and riprap protection downstream.

A sill at the downstream end of the basin will help prevent bottom shear flow on the channel bed downstream from the basin. Bos (1989) has discussion of designing basins for water measurement structures and designing riprap with proper underbase material.

Chapter 4 has further information on weirs but may indicate selection of a device other than a weir.

17. Sharp-Crested Weir Construction and Installation

Portable sharp-crested weirs may be used temporarily to provide approximate measurements of small flows in earth channels, lined tunnels, etc. For small earthen channels, the weir may be made from a piece of stiff sheet metal cut in the approximate shape of the cross section of the channel, but somewhat larger with a carefully cut weir notch in the top edge. To set this weir, the metal plate is forced firmly into the soft bottom and sides of the channel normal to the direction of flow. The crest is then adjusted to a level position by tapping down the higher side. Portable long-throated flumes can be used where head is insufficient for sharp-crested operation.

For larger channels and lined tunnels, a weir plate may be installed in a bulkhead that has been sandbagged and sealed in place. The opening in the bulkhead for a weir notch should be cut about 3 in longer than the crest length. This opening will allow insertion of metal crest plates to form the sharp crest and sides of the weir. Some approximate measurements have been made successfully with a combined weir and canvas dam. The bulkhead structure is used to fasten the canvas and bulkhead, which form a dam when held in place across the canal section by piling earth on the lower edge of the canvas.

For simple temporary weirs placed across channels, a flat-topped stake or post may be driven into the bed of the weir pool until its top is at the same elevation as the weir crest. The stake should be located in tranquil water close enough to the channel bank to be accessible. The depth of the water over this post is the head on the crest.

Designing weir structures requires consideration of all the general limits in section 5 and the limits specific to the type of weir crest selected. The approach flow conditions should be as described in chapter 2. In the past, many organizations developed sets of weir box structures for convenience. These weir sets commonly used standard weir equations for fully contracted weirs. However, for economy of structure, these weir boxes skimmed on crest height and side contractions and used head-to-crest length ratios of 1 to 1. Some of these preselected weir boxes, when compared with the improved Kindsvater relationships in section 6, indicated errors as high as 20 percent. With today's computers, calculators, and the improved Kindsvater relationships, economy of structure such as smaller structures and less head loss in certain cases can be achieved without loss of accuracy. The only disadvantage is that generating tables is more complex, but the task is easy with computers.

Frequently, suppressed weirs deliver much more water than operators think they have measured. This inaccuracy happens when air vents are not installed, are fully or partially plugged, or are undersized. Suppressed weirs must have proper ventilation of the cavity underneath their nappes. This ventilation is commonly done by installing properly sized pipes in the walls to vent the cavity under the nappe. Another way of providing air is to use the corner of an angle iron pointed upstream in the nappe to spread the water, forming an open airway.

Standard equations and tables are valid only when sufficient ventilation is provided. The weir will deliver more water than indicated by the tables and equations when ventilation is inadequate.

This inaccuracy occurs because the nappe sheet seals with the sidewalls, and the falling jet aspirates air from the cavity. The exiting flow carries the aerated water away, causing a negative pressure under the nappe. The negative pressure and some jet backflow raise the water behind the nappe sheet higher than the water exiting just downstream.

The height of pullup behind the nappe depends upon the drop, discharge, and crest length. The height that the water is pulled up behind the nappe is an estimate of the discharge error. For example, if the measuring head on a 3-ft suppressed weir is 1 ft, and the water behind the nappe pulls up 0.3 ft because of air demand, the error of discharge measurement would be about +6.5 percent. If the water was only pulled up 0.1 ft, the error for the same weir and measuring head would be +2.5 percent. However, some of the rise of water behind the nappe is due to backflow from the falling jet.

The design of pipe size to introduce sufficient air depends on the discharge, drop, and the loss of accuracy that is tolerable. Sizing air piping and air vents requires some knowledge of fluid mechanics and is difficult to do. Bos (1989) gives the equations to compute the undernappe pressure and a plot of discharge error versus under-nappe pressure for sizing air vents.

The weir structure should be set in a straight reach of the channel, perpendicular to the line of flow. The weir crest must be level and the bulkhead plumb. Adequate cutoff walls well tamped in place should be used on the weir structure to prevent undermining of the structure. The average width of the approach channel should be set to approximately conform to the size of the box for a distance of 10 to 20 ft upstream for the smaller structures and from 50 to 70 ft or more for the largest structures.

The weir box may accumulate sand and silt to such an extent that discharge measurements will be incorrect. For sluicing silt and sand deposits, an opening may be provided in the weir bulkhead at the floor line beneath the weir notch. This sluiceway should be provided with a suitable cover or gate to prevent leakage. If sediment is a severe problem, then sediment-excluding vortex tubes that bypass bed load with a small continuous flow may be more desirable than inaccuracies resulting from silt and sand.

18. Care of Weirs

The weir and weir pool should be kept free of weeds and trash. The weir pool should be cleaned of sediment as it accumulates. Frequent trimming of the channel and cleaning of the weir box structure or approach channel with shovel or scraper are necessary to maintain accurate flow measurement. This cleaning should extend from the bulkhead to upstream past the head measuring station. The invert of the pool must be kept low enough to maintain at least the minimum distance below the crest of the weir. This minimum distance is twice the maximum head on contracted weirs and three times the maximum head on suppressed weirs.

Frequent inspections should be made to determine whether leakage is occurring around the weir structures and through any sluicing clean out gate or cover.

If leakage does occur, remedial action should be immediately followed with careful rechecking to see that the weir is level and that its elevation corresponds to the zero elevation of the measuring gage. In any case, the crest of the weir should be checked periodically to verify that it is level and to verify correspondence to gage zero.

Care must be taken to avoid damaging the weir notch itself. Even small nicks and dents can reduce the accuracy of an otherwise good weir installation. Any nicks or dents that do occur should be carefully dressed with a fine-cut file or stone, stroking only in the plane of the upstream face of the weir plates or the plane of the beveled surface of the weir plates. Under no circumstances should any attempt be made to completely remove an imperfection, which will result in a change to the shape of the weir opening. Instead, only those portions of the metal that protrude above the normal surfaces should be removed.

19. Bibliography

Ackers, W.R., J.A. Perkins, and A.J.M. Harrison, *Weirs and Flumes for Flow Measurement*, John Wiley & Sons, New York, 1978.

Aisenbrey, A.J., Jr., R.B. Hayes, H.J. Warren, D.L. Winsett, and R.B. Young, *Design of Small Canal Structures*, Bureau of Reclamation, Denver, Colorado, 1978.

Bergmann, J.M., Compound Weir Study, Hydraulic Laboratory Report No. Hyd-505, Bureau of Reclamation, April 5, 1963.

Bos, M.G. (ed.), *Discharge Measurement Structures*, International Institute for Land Reclamation and Improvement, Publication 20, third revised edition, Wageningen, The Netherlands, 1989.

Brakensiek, D.L., H.B. Osborn, and W.R. Rawls (coordinators/editors), *Field Manual for Research in Agricultural Hydrology*, Agricultural Handbook 224, U.S. Department of Agriculture, U.S. Government Printing Office, Washington, DC, 1979.

Francis, J.B., *Lowell Hydraulics Experiments*, D. Van Nostrand, fourth edition, New York, New York, 1883.

International Organization for Standardization, "Measurement of Liquid Flow in Open Channels," Handbook No. 15, Geneva, Switzerland, 1983.

King, H.W., and E.F. Brater, *Handbook of Hydraulics*, fifth edition, McGraw-Hill Book Company, Inc., New York, 1963.

Kindsvater, C.E., and R.W. Carter, "Discharge Characteristics of Rectangular Thin-Plate Weirs," Paper No. 3001, *Transactions*, American Society of Civil Engineers, vol. 124, 1959.

Kulin, G., and P.R. Compton, "A Guide to Methods and Standards for the Measurement of Water Flow," Special Publication 421, National Bureau of Standards, 1975.

Palde, U.J., *Hydraulic Laboratory Studies of a 4-Foot-Wide Weir Box Turnout Structure for Irrigation Use*, Report REC-ERC-72-31, Bureau of Reclamation, Denver, Colorado, September 1972.

Shen, J.A., "Preliminary Report on the Discharge Characteristics of Trapezoidal-Notch Thin-Plate Weirs," U.S. Geological Survey, July 1959.

Simmons, W.P., and W.D. Case, *Hydraulic Model Studies of Small Weir Box Turnout Structures for General Irrigation Use*, Hydraulic Laboratory Report No. Hyd-396, Bureau of Reclamation, Denver, Colorado, October 21, 1954.

Skogerboe, G.V., L.M. Hyatt, and K.O. Eggleston, "Design and Calibration of Submerged Open Channel Flow Measurement Structures, Part 4-Weirs," Report WG31-5, Utah State University, May 1967.

Wahlin, B.T., and J.A. Replogle, *Flow Measurement Using an Overshot Gate*, published for Reclamation by UMA, Inc., 1994.

CHAPTER 8 - FLUMES

1. General

Flumes are shaped, open-channel flow sections that force flow to accelerate. Acceleration is produced by converging the sidewalls, raising the bottom, or a combination of both. When only the bottom is raised with no side contractions, the flume is commonly called a broad-crested weir. When the downstream depth is shallow and enough convergence exists between the upstream and downstream channels, the flow passes through critical depth. Therefore, flumes are sometimes called critical-depth flumes. When flow passes through critical depth, a unique water surface profile occurs within the flume or broad-crested weir for each discharge. This condition is known as free flow. For this case, upstream heads at one location relative to the control bottom elevation near the region of critical depth can be used to determine a usable head versus discharge relationship for flow measurement.

Flumes range in size from very small-1 inch (in) wide-to large structures over 50 feet (ft) wide that are installed in ditches, laterals, and large canals to measure flow. These flumes cover a corresponding discharge range of 0.03 to over 3,000 cubic feet per second (ft^3/s) although no particular upper size limit exists. Commonly, irrigation channels are designed to operate at near bank full to extend delivery coverage and, when the landscape is flat, to minimize earthwork involved in bank height construction. Therefore, some flumes have been calibrated for the condition when the critical depth has been nearly drowned by downstream backwater either purposely or by later increase of downstream flow resistance. To measure discharge with high levels of submergence, two head measurements are required, which results in significant loss of accuracy compared to free-flow measurements.

Flume head loss is less than about one-fourth of that needed to operate a sharp-crested weir having the same control width, and in some long-throated flumes, may be as low as one-tenth. Another advantage compared to most standard weirs is that for a properly designed and installed flume, the velocity of approach is a part of the calibration equations. Unauthorized altering of the dimensions of constructed flumes to obtain an unfair share of water is difficult and, therefore, not likely. Velocity of flow can usually be designed to minimize sediment deposition within the structure. Gradual convergence sections at the entrance tend to improve velocity distribution of approach flow and the passage of floating debris. Some flumes can be more expensive than sharp-crested weirs or submerged orifices in unlined channels.

2. Flume Classes

Many kinds of flumes are in use. The two basic classes or forms of flumes are discussed below.

(a) Long-Throated Flumes

Long-throated flumes (figure 8-1) control discharge rate in a throat that is long enough to cause nearly parallel flow lines in the region of flow control. Parallel flow allows these flumes to be accurately rated by analysis using fluid flow concepts. The energy principle, critical depth relationships, and boundary layer theory are combined to rate flumes and broad-crested weirs by Ackers et al. (1978) and Bos et al. (1991). Thus, the long-throated flumes and modified broad-crested weirs are amenable to computer calibrations.

Long-throated flumes can have nearly any desired cross-sectional shape and can be custom fitted into most canal-site geometries. The modified broad-crested weirs (Replogle, 1975; Bos et al., 1991), also called ramp flumes (Dodge, 1983), are styles of long-throated flumes.



(a) Long-throated flume (broad-crested weir) under construction.



(b) The long-throated flume (broad-crested weir) with approximately 1,200 ft³/s.

Figure 8-1 -- Large long-throated flume for left to right flow in Arizona canal (courtesy of U.S. Water Conservation Laboratory, Phoenix, Arizona).

(b) Short-Throated Flumes

Short-throated flumes are considered short because they control flow in a region that produces curvilinear flow. Although they may be termed short throated, the overall specified length of the finished structure, including transitions, may be relatively long. The Parshall flume is the most common example of this type of flume (figure 8-2). These flumes would require detailed and accurate knowledge of the individual streamline curvatures for calculated ratings, which is usually considered impractical. Thus, calibrations for short-throated flumes are determined empirically by comparison with other more precise and accurate water measuring systems.



Figure 8-2 -- Four-foot, short-form Parshall flume, discharging $62 \text{ ft}^3/\text{s}$ under free-flow conditions. Scour Protection is needed for this much drop.

3. Other Special Flumes

Many flumes have been designed for organizational preferences and special uses. Many of these are considered short-form flumes. Some examples are shown on figure 8-3, and some are briefly discussed in this section.

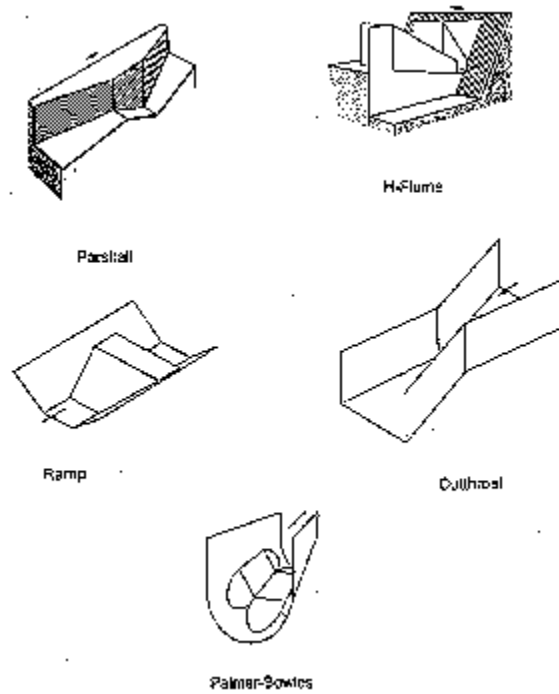


Figure 8-3 -- Some typical flumes.

(a) H-Flumes

H-flumes, developed by the Natural Resources Conservation Service (former known as the Soil Conservation Service) (Brakensiek, et al., 1979; Kulin et al., 1975), are made of simple trapezoidal flat surfaces. These surfaces are placed to form vertical converging sidewalls. The downstream edges of the trapezoidal sides slope upward toward the upstream approach, forming a notch that gets progressively wider with distance from the bottom. These flumes should not be submerged more than 30 percent. This group of flumes, including H-flumes, HS-flumes, and the HL-flumes (Brakensiek et al., 1979; Gwinn and Parsons, 1976) have been used mostly on small agricultural watersheds and have not found extensive use in irrigation flow measurements.

(b) Cutthroat Flumes

Cutthroat flumes are so named because they resemble Parshall flumes with the throat "cut out." They are formed by directly connecting a 6:1 converging section to a similar diverging section. Thus, they consist of a converging level inlet section with vertical sidewalls and a diverging level outlet section also with vertical sidewalls. They do not have any parallel walls

forming a straight throat (Skogerboe et al., 1973) and, thus, belong to a class of throatless flumes. The converging and diverging walls do not necessarily match those of other flumes in either converging or diverging slope or length. The primary objective of their development was construction simplicity compared to Parshall flumes.

However, the prescribed head measuring location, which may be in a zone of separation, and conditions of the upstream channel in which it is placed, along with variable conditions of the sharp connection of the convergence and the divergence, have caused considerable variability in calibrations. Because of these complexities in hydraulic behavior, several authors do not recommend their use (Ackers et al., 1978; Bos, 1989).

(c) Palmer-Bowles Flumes

Palmer-Bowles flumes (Wells and Gotaas, 1958) are frequently made as inserts with circular bottoms that conveniently fit into U-shaped channels or partially full pipes. These flumes make a transition from a circular bottom section to a raised trapezoidal throat and transition back to a circular bottom section. These flumes are of the long-throated type and can be calibrated by theoretical analysis.

(d) Flat-Bottomed Trapezoidal Flumes

Flat-bottomed trapezoidal short-form flumes were first developed to be placed in canals and to conform more closely to usual small canal shapes (Robinson and Chamberlain, 1960). Therefore, if possible, the cross section of the canal and the start of the converging portion of the flume should match. They were designed to set flush with respect to the bottom of the incoming channels in an effort to assist sediment movement and allow the canal to drain dry between uses. Although the latter objective was achieved, the authors did not establish whether sediment movement was a function of upstream velocity or floor configuration.

Although these early versions were laboratory calibrated, more recently, they were found to conform to the analysis procedures for long-throated flumes for heads less than about 50 percent of maximum. For higher depths, their throats become too short for precise long-throated flume analysis, and the laboratory ratings should be used. Except for those already in existence, and for which the user may need calibrations, these flumes are generally being replaced with versions having longer throats, making them long-throated flumes that can be calibrated by analysis.

(e) Special Flumes for Passing Sediment

Where sediment is a major problem, special flume types have been designed to obtain flow measurements in these adverse conditions. Included in these devices are the trapezoidal supercritical-flow flume, the Walnut Gulch flume, and the San Dimas flumes which slope in the direction of flow (Brakensiek et al., 1979). These flumes are considered to be a class of supercritical flumes. Usually, they are characterized as requiring extensive head drop to operate and find limited application in irrigation.

4. Submergence

All flumes have a minimum needed head loss to assure that free flow exists and that only an upstream head measurement is needed to determine discharge rate. This required head loss is usually expressed as a submergence limit defined by the ratio of the downstream head to the upstream head, both referenced to the flume throat bottom. The term "modular limit" is defined as this limiting submergence ratio for a particular flow module, which causes no more than a 1-percent deviation in the upstream head reading for a given discharge. When these limits are exceeded, an additional downstream head measurement is sometimes used to extend the measurement range of a flume, particularly for Parshall and cutthroat flumes, but at considerable loss of accuracy. Submergence also increases upstream channel depth, decreasing the upstream velocity, which may aggravate sedimentation problems.

Long-throated flumes can tolerate high submergence in some cases. Trying to extend their measurement range with a downstream head measurement is not recommended. They can be designed to have submergence limits (modular limits) ranging from 65 to 95 percent, depending on discharge rate, shape, and exit channel energy conditions. For example, a flume discharging into a channel that is similar in size and shape to the approach channel can have submergence limits that calculate to exceed 82 to 95 percent for minimum to maximum flow rate, provided an expansion section is used, and from about 72 to 93 percent without an expansion section. The same flume, when discharging into a lake, may have submergence limits of only 65 to 80 percent, decreasing further to about 60 to 70 percent if there is no expansion section. Thus, some knowledge of the installation site is needed before a required head loss can be assigned.

Visual determination of limiting submergence for most flumes can be difficult. However, for long-throated flumes, this condition is relatively easy to recognize. Several references offer guidelines in terms of standing diagonal wave locations to aid visual determination of flow submergence (Bos et al., 1991; Clemmens et al., 1993). In general, if the downstream hydraulic jump causes a frothy wave line across the channel that is at or beyond the end of the contracted throat section, the flume has not reached its limiting submergence-the modular limit. If the wave is on the throat, or no wave is visible, the flume is beyond its submergence limit, and the measurement would be invalid.

For long-throated flumes, painting lines projecting up the channel walls to denote the downstream end of the crest to aid visual distinction is suggested (Bos et al., 1991). Distinction in terms of wave location in Parshall flumes is not so clear. In the absence of visual observation in any of the flumes, automatic recording operations may need a second downstream head measurement if the opportunity for excessive backwater exists. This measurement would warn of invalid data.

Some states have laws that require Parshall flumes by name for certain situations. Past designs for Parshall flumes tended to overuse submergence for economic savings with the only caveat that submergence should not exceed 95 percent. However, today, designing for this level of submergence is not considered good practice in view of accuracy loss and a hysteresis discontinuity in the submergence correction function described in the section on Parshall flumes in this chapter.

5. Site Characteristics Related to Locating, Selecting, and Setting Flumes

Proper location of the flume is important from the standpoint of accuracy and ease of operation. For convenience, the flume should be located near the diversion point and near the regulating gates used to control the discharge. Flumes should be readily accessible by vehicle for both installation and maintenance purposes. All structures for measuring or regulating the rate of flow should be located in a channel reach where an accurate head can be measured. The survey of a channel to find a suitable location for a structure should also provide information on a number of relevant factors that influence the performance of a future structure.

(a) Approach Conditions

Flumes should not be installed too close to turbulent flow, surging or unbalanced flow, or a poorly distributed velocity pattern. Poor flow conditions in the area just upstream from the measuring device can cause large discharge indication errors. In general, the approaching flow should be tranquil. Tranquil flow is defined as fully developed flow in long straight channels with mild slopes, free of curves, projections, and waves.

Studies of approach requirements for closed conduits have led to the acceptance of 10 diameters of straight pipe as sufficient for pipe meters claiming to be accurate to within 0.5 to 1 percent. By the usual hydraulic analogy, open channel flow would require 40 times the hydraulic radius of straight, unobstructed approach channel. The hydraulic radius is the area of flow section divided by the wetted perimeter, which becomes $d/4$ for full pipes; hence, the suggested 40 times hydraulic radius approach distance. These requirements can probably be relaxed because open channel measuring flumes claim accuracy to a wider margin of 2 to 5 percent. However, for a rectangular channel that is twice as wide as it is deep, 40 times the hydraulic radius is numerically equal to 10 top widths.

Bos et al. (1991) gives approach length requirements stated in various terms of flow depths, head readings, and widths as follows:

- (1) If the control width is greater than 50 percent of the approach channel, then 10 average approach flow widths of straight unobstructed approach are required.

(2) If the control width is less than 50 percent, then 20 control widths of straight unobstructed approach are required.

(3) If upstream flow exceeds critical velocity, a jump should be forced to occur. In this case, 30 measuring heads of straight unobstructed approach after the jump is completed should be provided.

(4) If baffles are used to correct and smooth approach flow, then 10 measuring heads should be placed between the baffles and the measuring station.

Approach velocities less than 1 foot per second (ft/s) encourage aquatic pests, insects, and sediment deposition, so the approach velocity should exceed 1 ft/s if at all practical. To prevent wave interference of head measurement, the Froude number of the approaching channel flow should be less than 0.5 for the full range of anticipated discharges and should not be exceeded over a distance of at least 30 times the measurement head before the structure.

It is recommended that a check be made of the approach velocity condition by current meter measurements, especially when using baffles. In any case, approach condition should be verified visually. Visual inspection should be made for obvious boils and backflows and unstable surface conditions.

(b) Channel Flow Characteristics and Operational Needs

For accurate measurements, sufficient head loss must be created to obtain a unique discharge versus head relationship. This relationship assures that submergence limits have not been exceeded and modular flow exists. To prevent submergence altogether or to assure that excessive submergence does not occur, the designer needs to know whether the downstream water surface elevation relationships are consistent and do not change with season or whether they are influenced by operation of gates, reservoir operation, or other laterals. The channel water levels greatly influence the sill height necessary to keep the downstream water surface below the submergence limit, thus obtaining modular flow for the needed discharge range.

The amount of downstream flow resistance and, hence, the water surface elevation, is likely to vary with sediment deposits, debris, canal checking operations, vegetative growth, and aging. For a new design, careful assessment of friction, including the effects of relative roughness, is required. A thorough appraisal of needed canal operations is required to determine the frequency of measuring different discharges, including the normal design flow and the maximum design flow.

To select or design an appropriate flume for installation in an existing channel, full advantage should be taken of making field measurements at different discharges to obtain thorough knowledge of channel performance at the site. After tentatively selecting the flume location, information should be obtained on the maximum and minimum flows to be measured, the corresponding flow depths, the maximum velocity, and the dimensions of the channel at the site. These measurements should include channel widths, side slopes, depths, and the height of the upstream banks with special attention to their ability to contain the increased depth caused by the flume installation.

(c) Erosion And Scour

Ideally, the selected channel reach should have a stable bottom elevation. In some channel reaches, sedimentation occurs in dry seasons or periods. These sediments may be eroded again during the wet season. Sedimentation may change approach velocity or may even bury the structure, and the erosion may undercut the foundation of the structure.

Based on the channel water levels and the required sill height, in combination with the discharge versus head relationship of the structure, ponding at the upstream structure should be assessed. Excessive ponding commonly causes sedimentation difficulties because of the subsequent reduction in the approach flow velocities. To avoid upstream sedimentation, the sill height plus the measuring head should be about the same as for the approach channel over as much of the discharge measuring range as practical. This arrangement will help reduce sedimentation upstream from the structure.

The required drop may exceed the capacity of soil lined channels to resist scour, and foundations may scour. Thus, rock armoring may be needed to prevent undermining. For more details on sediment handling, see Bos (1989) or Bos et al. (1991).

6. Workmanship

Flumes require accurate workmanship for satisfactory performance. Short flumes will provide reasonably accurate flow measurements if the standard dimensions are attained during construction. For accurate flow measurement, the flow surfaces must be correctly set or placed at the proper elevation, the crest must be properly leveled, and the walls must be properly plumbed. Although long-throated flumes can be computer recalibrated using as-built dimensions to correct for moderate form slipping or errors of construction, correcting for throat-section slope in the direction of flow is not always satisfactory. In any case, adequate care during construction is preferable. The modified broad-crested weir flume has only one critical flow surface, and it is level.

Flumes should be set on a solid, watertight foundation to prevent leakage around and beneath the flume and prevent settlement or heaving. Collars or antiseep walls should be attached to either or both the upstream and downstream flanges of the flume and should extend well out into the channel banks and bottom to prevent bypass flow and foundation settlement caused by erosion. A stable foundation without significant settling or leakage must be secured at reasonable costs.

The flumes can be built of wood, concrete, galvanized sheet metal, or other materials. Large flumes are usually constructed on the site, but smaller flumes may be purchased as complete flumes and placed in one piece. Others are provided in bolt-together pieces which are assembled onsite. Some of these flumes are made of lightweight materials, which are then made rigid and immobile by careful earth backfill or by placing concrete outside of the walls and beneath the bottom.

When making a number of relatively small concrete flumes of the same size, use of portable and knockdown reusable forms is economical and practical. These forms require high quality design and workmanship.

Good construction practice should be used in placing footings, setting the forms, and pouring and tamping wall concrete to provide smooth surface finishes. Accuracy of the short flumes depends on correct flume dimensions, proper setting, and proper use. As flume size decreases, the influence of a small dimensional error becomes more prominent, and the importance of this care increases.

7. Head Measurements

The head is usually sensed either in the channel itself or in a stilling well located to one side of the channel. The stilling well is connected by a small pipe to the channel. Many methods can be used to detect the water surface in a stilling well or in the flume channel. Some methods exploit the electrical conductance of water and capacitance of immersed insulated wires. Sonic sensors depend on timing sound pulses reflected from the water surface. Measurement heads can also be determined with a variety of pressure sensing devices. The most frequently used methods are wall-mounted staff gages in the entrance section of the flume or in a stilling well or float-operated recorders placed in a stilling well.

(a) Location for Head Measurement

The measuring station for short-form flumes must be installed as specified to match closely the location used when the flume was empirically calibrated. For example, the measuring station of a Parshall flume is in the convergence water surface drawdown. For long-throated measurement structures, the gaging or head-measuring station should be located sufficiently far upstream to avoid detectable water surface drawdown, but close enough for the energy losses between the gaging station and approach section to be negligible. This placement is particularly critical if the ratings are based on coefficient values in a discharge equation as discussed in Bos (1989). In the computer derived ratings, drawdown and friction losses caused by the gage location are an integral part of the calculation. Therefore, the gage should be located as indicated in the pre-computed long-throated structure design and selected tables.

(b) Selection of Head-Measurement Device

The success or failure of the structure and the value of the collected data depend closely on the proper selection of a suitable head measurement device. The three most important factors that influence this selection are: (1) frequency of discharge measurement, (2) allowable error in the head detection, and (3) type of measurement structure under consideration.

The usual expected reading errors in the sill-referenced head are listed in table 8-1 for some common head measurement devices. The listed errors are higher than the expected random errors, partly to compensate for the effects of several systematic errors, such as zero-setting, instrument lag, reading error, temperature, and stilling well leakage. If no device with sufficient accuracy is found from this procedure, two choices are available: (1) allow greater error in the measured discharge for the minimum required head loss or (2) redesign the structure with a narrower bottom width, resulting in a higher value of minimum measurement head.

(c) Staff Gages

Periodic readings on a calibrated staff gage may serve adequately when continuous information on the flow rate is not required. Examples are canals where the flow changes are gradual. The gage should be placed so that the water level can be read from the canal bank. The gage should be easy to clean.

Table 8-1. Common reading errors in flat crest reference head as detected by various devices			
Device	Reading error Δh_1 , ft		Remarks
	<i>If head detection is in</i>		
	Open channel	Stilling well	
Point gage	Not applicable	0.0015	Commonly used for research
Dipstick	Not applicable	0.003	Good for research/field use
Staff gage	0.013 0.023 > 0.050	0.013 0.016 0.023	$F_1 \leq 0.1$ $F_1 = 0.2$ $F_1 = 0.5$
Pressure bulb + recorder	0.066	Not required	Suitable for temporary installations (Error = $\pm 2\%$ h_{1max}).
Bubble gage + recorder	0.033	Not required	Stilling well is not required but can be used
Float-operated recorder	Not applicable	0.016	Stilling well is required
Float totalizer attached to recorder	-	-	Some additional random and systematic error is possible

For concrete-lined canals, the gage can be mounted directly on the canal wall. The value for measuring head on the sloping walls of trapezoidal-shaped canals must be appropriately converted to vertical head values before entering the discharge tables. These tables are usually made for stilling well use or vertical gage applications. The sloping gage can be marked to read direct values or equivalent values of vertical head. Sometimes, sloping staffs are marked to display discharge directly, but the discharge gradations are not equally spaced. The gage may be mounted onto a vertical support for unlined canals.

Most permanent gages are enameled steel, cast aluminum, or some type of plastic resin. Enameled linear scales marked in metric or English units are available from commercial sources. An example staff gage is shown on figure 8-4. Important flow rates can be noted on these scales by separate markings, allowing convenient adjustment of control gates to desired discharges without requiring tables. For convenience, the gages can be marked directly in discharge units rather than in measuring head units.

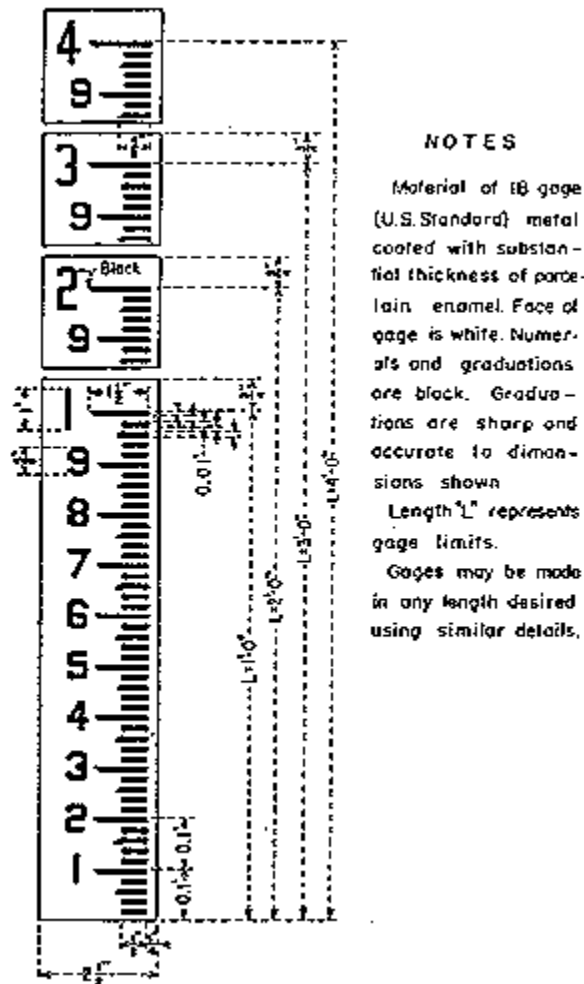


Figure 8-4 -- Typical staff gage for measuring head or water stage.

(d) Stilling Wells

For accurate discharge measurements, the effective head in flumes, accurately referenced to a known elevation in the flume, must be measured. Head readings on staff gages attached directly to the inside channel walls may be only estimates because of waves and turbulent fluctuations on the scale face. Thus, stilling wells are connected by holes and pipes to the body of water at the measuring station to translocate head and dampen water surface fluctuations by throttling, which increases head measurement accuracy.

The pipe connecting the stilling well to the flume/canal should be large enough to allow the stilling well to respond quickly to water level changes. Usually, this pipe diameter is about one-tenth the diameter of the stilling well. However, special cases may require more dampening using smaller connecting pipe diameters.

The pipe connection to the stilling well should be perpendicular and carefully cut flush with both the canal and the stilling well walls. Otherwise, the translocated water surface elevation in the well can deviate considerably from the actual elevation in the flume because of flow velocity impact or aspiration.

Connections that are not flush and/or have rough edges have different head losses depending on direction of flow in the connecting piping. This causes buildup or reduction of head in stilling wells compared to the actual head in the measurement device.

The size of the stilling well depends on the method used to measure the head. The diameter, if circular shaped, ranges from a recommended minimum size of 4 in for hand-inserted dipsticks to 18 in to accommodate larger diameter floats. Wells may be much larger to provide access for cleaning or to make the reading of wall attached staff gages at sight angles at least as flat as 30 degrees. It is recommended that well walls have a 2-in clearance from floats and weights used with recorders.

A stilling well may need to house the float and recorder system or other surface detecting equipment. The wells may need to be tall enough to provide convenient access to recorders for reference setting and maintenance. The wells may also need to be tall enough to keep counterbalance weights from interfering with float movement.

Before making a measurement, the wells should be flushed with fresh water to be sure they are free of sediment, foreign material, or blockages, which could cause erroneous head readings. Recording equipment should be checked and serviced regularly. Cross-checks should be made between the staff gages, hook gages, plumb bobs, recorder values, and any other discharge indicators to expose system errors. Thus, even when using stilling wells, staff gages should still be used on the insidewalls of flumes for cross-checking. Further details on stilling wells can be found in chapter 6 and Bos (1989), Bos et al. (1991), and Brakensiek et al. (1979).

(e) Gage Installation and Zero Setting

The most important factor in obtaining accurate discharge measurements is the accurate determination of the sill-referenced head, h_1 . The upstream sill-referenced head can be measured by a gage or recorder only if the observed water level is known with respect to the weir sill (or flume crest) level at the control section. The method used to set (zero register) the gage, recorder, etc., depends on the structure size, the flow rate in the channel during the setting procedure, and available equipment. Standard surveying techniques are practical for accurate setting of most wall or staff gages.

The canal side slopes usually only approximate the intended slope. Mounting sloped gages so that a selected scale reading in the most frequently used range of the gage coincides with the corresponding elevation for that reading will partially compensate for deviation from design slope. Thus, the greatest reading errors will occur in the flow ranges that are seldom used. If this procedure causes the zero end of the scale to be displaced by more than about 0.015 ft, the actual side slope should be determined for adjustments to the calibration. This determination also should be made if accuracy over the full flow range is required.

Several methods can be used to zero a water level recorder; three are particularly suitable. The recorder can be set: (1) when the canal is dry, (2) when water is ponded over the flume, or (3) when water is flowing through the flume. These zero-setting methods assume that the sill-referenced elevation can be determined during the procedure. This determination is not always possible, especially on wide structures.

A stable and permanent surveying bench mark, such as a bronze cap placed in concrete, should be added in an acceptable location near the measuring structure. Its elevation should have been previously established relative to the sill elevation. More detailed information on zero-setting procedures is presented in Clemmens et al. (2001) and Bos et al. (1991).

8. Long-Throated Measurement Flumes

Long-throated flumes are coming into general use because they can be easily fitted into complex channel shapes as well as simple shapes (Replogle, 1975; Bos et al., 1991). Long-throated flumes have many advantages compared to other measuring devices, including Parshall flumes. Long-throated flumes are more accurate, cost less, have better technical performance, and can be computer designed and calibrated. Thus, long-throated flumes are preferred over Parshall flumes for new installations. However, some states may have laws or compact agreements mandating the use of Parshall flumes in certain situations.

(a) Characteristics of Long-Throated Flumes

The cross-sectional flexibility of long-throated flumes allows them to fit various channel shapes more conveniently than short-throated flumes, which have fixed sizes and shapes. Because of the ability to match the channel shape, the construction of forms is usually simplified. In contrast, the fixed geometry of short-throated (including Parshall) flumes usually makes upstream and downstream transitions necessary and may require long wingwalls. Because of their flexibility and capability to fit any channel shape, long-throated flumes have more gradual transitions. Thus, floating debris presents fewer problems. Also, field observations have shown that the structure can be designed to pass sediment transported by channels with subcritical flow.

A simple type of long-throated flume developed and described by Replogle et al. (1991) consists of a flat raised sill or crest across a trapezoidal channel with an approach ramp transition from the approach channel invert. The crest drops vertically at the downstream end back to the downstream canal invert. These flumes (figure 8-5) have been called Replogle flumes, modified broad-crested weirs, and ramp flumes. This simple version of the long-throated flume is formed with only two bottom planes. An optional third plane can be used for maximum head recovery. The lined canal shape serves as the flume approach section, compared to constructing 9 to 12 planes for Parshall flumes. It is usually easier to construct the two to three planes of the long-throated flumes.

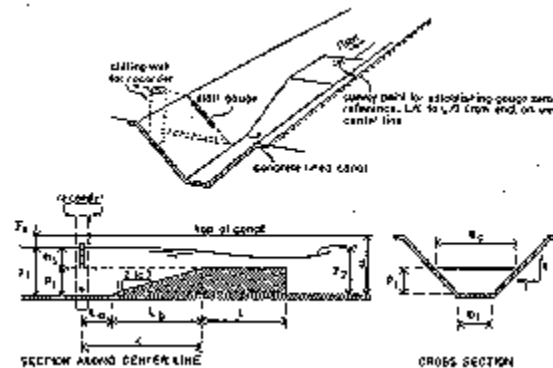


Figure 8-5 -- Flat-crested, long-throated flume in concrete-lined canal.

Some confusion of terminology exists here. Some investigators would consider the ramp flume a broad-crested weir because the flow constriction is produced from a bottom transition alone, whereas a flume would depend to some extent on side convergence. Both long-throated flumes and broad-crested weirs can be accurately rated by analysis using fluid flow concepts. The energy principle, critical depth relationships, and boundary layer theory are combined when computer calibrating these flumes and weirs. Because of this close connection, this manual will consider and call both the long-throated flumes and broad-crested weirs longthroated measurement structures.

Cost estimates for a large 930ft³/s ramp flume varied from about 45 to 60 percent of that for a Parshall flume in a retrofit situation. Clemmens and Replogle (1980) cited costs of onetenth to onethird of equivalent Parshall flumes for a small ramp-type, long-throated flume. Some of the cost differences between small and large structures result from the need for service roads, foundation differences, and repair of approach channel surfaces in retrofit designs.

Long-throated flumes can be computer calibrated to within ± 2 percent plus head measurement error and have submergence limits up to 90 percent. Even when the listed submergence limits are near 70 percent, the absolute head loss or water surface drop through the long-throated flumes may be smaller than the older structures, depending on the particular design selection from among the many choices of shape.

Short-throated flumes can measure free flow accurately in the range of ± 3 to ± 5 percent plus head measurement error and have submergence limits from 50 to 80 percent. Increased uncertainty occurs when using flow corrections to obtain discharge rates beyond submergence limits commonly up to 95 percent. However, Peck (1988) found large correction errors caused by hysteresis shifts of the downstream wave front at a submergence of 90 percent. Correction is frequently done above 90-percent submergence with Parshall flume measurements. Using submergence corrections commonly results in discharge errors ranging from 7 to ± 20 percent, and possibly much more, as differences in upstream and downstream measuring heads become small.

With most flumes, close adherence to tolerances during construction is required to rely on empirical equations and calibrations provided for each specific short-throated flume. Dimensional errors and slippage of the forms frequently cause unacceptable errors that are difficult to resolve without laborious field calibrations. Field calibrations for submergence correction are very cumbersome and time consuming because of the usual project operational limitations, difficulties of controlling heads, and the need for long lag times for heads to settle to asymptotic levels. However, long-throated flumes can usually be computer recalibrated using as-built dimensions if form slippage has not caused crest slope in the direction of flow. Even then, crest correction may be practical and relatively inexpensive.

The measured heads in the short-throated flumes do not always indicate system head loss. For example, the upstream measured head of a Parshall flume is located about one-third of the way into its converging crest section, and the water surface may have a considerable drawdown from the approach canal surface elevation. This factor makes size selection and crest elevation setting more complicated than for long-throated flumes that approximate existing channel dimensions and shape.

Because long-throated flumes have greater tolerance to submergence than short-form flumes and weirs, they can deliver more discharge without having to consider the effects of submergence, which usually requires observation of a downstream depth. For example, Parshall flumes require 3 to 4 times the absolute water surface fall through the structure for free-flow measurements than long-throated flumes (Bos et al., 1991). Long-throated flumes, with tolerances for high submergence ratios, require only one head measurement. They are considered to be more accurate and economical than, for example, extending Parshall flume measurement range by submerging up to comparable long-throated flume submergence limits and making corrections using two head measurements.

Because long-throated flumes fit nicely into existing flow channels, they are convenient for making portable measurement devices. Portable long-throated devices for flow rates up to about 2 ft³/s are described in Bos et al. (1991), for trapezoidal and rectangular cross sections.

(b) Summary of Long-Throated Flume Advantages

The main advantages of long-throated flumes are:

- (1) Provided that critical flow occurs in the throat (not excessively submerged), a rating table can be calculated with an error less than ± 2 percent. This calculation can be done for any combination of a prismatic throat and an arbitrarily shaped approach channel.
- (2) Long-throated flumes can have nearly any desired cross-sectional shape and can be custom fitted into most canal-site geometries. The throat cross section can be shaped in such a way that the complete range of discharge can be measured accurately.
- (3) Long-throated flumes can be made into portable devices that fit conveniently into open channels with considerably less complicated construction forming.
- (4) The required head loss over the long-throated flume to obtain a unique relationship between the upstream sill-referenced head and the discharge is small. This head-loss requirement may be estimated with sufficient accuracy for any of these flumes placed in any channel.
- (5) Because of their gradual converging transition, these flumes have few problems with floating debris and sediment. Field observations have shown that the flume can be designed to pass sediment transported by channels with subcritical flow.
- (6) Provided that the throat is horizontal in the direction of flow, a rating table can be produced that is based on post-construction dimensions. This horizontal orientation is required to allow an accurate rating table to be made to compensate for deviations from design.
- (7) Under similar hydraulic and other boundary conditions, long-throated flumes are usually the most economical of all structures for accurately measuring flow.
- (8) Long-throated flumes are amenable to selection, design, and calibration by computer techniques.

(c) General Design Procedures for Long-Throated Flumes

The major steps of the design process for long-throated flumes are: (1) selection of site, (2) selection of head measurement techniques previously discussed, and (3) selection of an appropriate structure. Design is an iterative process between these steps. The order and importance of these steps depend on the specific conditions encountered.

To properly select and design a measurement structure, all demands and operational requirements to be made on the structure should be listed and matched with the properties of the known structures. These demands and operational requirements originate from four sources: (1) the hydraulic performance, (2) the construction or installation cost, (3) the ease with which the structure can be operated, and (4) the cost of maintenance. The imposed demands will be discussed in more detail. Factors that affect design and selection such as submergence, site characteristics, workmanship, and head measurement systems are discussed earlier in this chapter.

(d) Determining Shape and Size of the Structure

Long-throated flumes operate by using a channel contraction to cause critical flow. Insufficient contraction will prevent critical flow. Under this condition, flow is then non-modular or submerged and gage readings are meaningless. Too much contraction may raise the water surface upstream and cause canal overtopping or sediment deposition problems. The designer's problem is to select the shape of the control section or throat such that critical flow occurs through-out the full range of discharge measurement and produces required accuracy. Also, the designer must provide acceptable head reading sensitivity. Usually, the sensitivity of the structure at maximum flow is selected such that a change in measurement head, h_1 , of about 0.03 ft causes less than a 10-percent change in discharge. Achieving these design requirements may seem difficult, but existing design aids and rating tables make this task more manageable.

(e) Computer Design Versus Sets of Pre-calibrated Long-Throated Flumes

A thorough treatment of the computational process and several pre-computed, standard-size, long-throated flumes for a variety of canals and natural channels are presented in Bos et al. (1991). The U.S. Water Conservation Laboratory, Agriculture Research Service, U.S. Department of Agriculture, developed the first computer programs for designing and calibrating long-throated flumes.

WinFlume (Wahl et al. 2000) is the most advanced software for analysis of long-throated flumes. The program is Windows-based and can be downloaded from http://www.usbr.gov/pmts/hydraulics_lab/winflume/. Ratings are determined by numerical solution of the critical-flow equations, accounting for boundary friction and other losses. The program includes a module that simplifies and accelerates the process of developing acceptable flume designs.

Clemmens et al. (2001) and Bos et al. (1991) provides calibration tables in metric (S.I.) and English units for a set of long-throated flume dimensions that covers a discharge range from about 2.8 to 280 ft³/s for trapezoidal channel shapes with side slopes of 1:1 to 1:1.5 horizontal and with bottom widths from about 1 to 5 ft. They also provide instructions for construction and field placement. Calibration tables for long-throated rectangular flumes are also presented.

The S.I. tables are reproduced in Cheremisinoff et al. (1988). Statistically fitted equations in S.I. units that closely reproduce the computed tables are presented in Hoffman et al. (1991).

The above references and this manual provide design and calibration tables for selecting and sizing long-throated structures from sets of predetermined, dimensioned, and precalibrated structures or from dimensionless design tables for some special structures. However, computer techniques are much preferred for all installations, designs, and calibrations for long-throated flumes. Thus, when practical, long-throated flumes should be designed using the WinFlume computer program (http://www.usbr.gov/pmts/hydraulics_lab/winflume/). Using restricted sets of dimensions reduces the capability of more exact custom fitting to shapes of existing channels, which can make it difficult to attain discharge range requirements. The need for computer techniques becomes much more important for large long-throated structures.

9. Pre-computed Design and Selection Tables for Long-Throated Flumes

Pre-computed designs and selections are provided in tables 8-2 through 8-5. These tables are provided for the convenient design and selection of long-throated structures in the field or office without use of a computer. These tables provide long-throated flume selections that can be fitted into lined trapezoidal, rectangular, circular, and earthen channels. All of the structure choices provided in the design tables consist of a simple ramp rising from the channel bottom followed by a flat horizontal crest or sill to form a broad-crested weir and ending in an abrupt drop. Tables 8-2 and 8-3 are for lined trapezoidal channels. Table 8-4 is for lined rectangular channels or earthen channels. Table 8-5 is for long-throated flumes that fit into circular conduits flowing partially full.

Long-throated V-shaped flumes which are used in natural channels are not included in this manual. Structures for natural streams are discussed in more detail in Brakensiek et al. (1979). Also, trapezoidal flumes with side contractions which are not generally selected for usual irrigation situations are not included in design tables. These flumes are usually more difficult to construct, more expensive, and increase head loss.

The calibration equations were developed from discharge tables computed with WinFlume and its predecessors (Clemmens et al., 1987 and 1993). Two equation forms are commonly used: a third-degree polynomial and a power form. The power form is selected here because it looks similar to the historical equations for weirs and flumes. It should be remembered that these equations are simply curve-fit results with no theoretical derivation. The equation coefficients, exponents, and constants are provided in tables 8-2 through 8-5. The pre-calibrated flumes in the tables have been sorted from innumerable possible choices based on practical experience and theory and reduced to a relatively few selected structures from which the designer may choose.

Table 8-2. — Long-throated flume sizes and discharge ranges for lined trapezoidal canals (English units)^{a,c}

Canal Shape		Maximum canal depth ^b , <i>d</i> (ft)	Range of Canal Capacities		Weir selection (table 8-3)	Weir Dimensions		Minimum head loss, ΔH^a (ft)
Side slope Z_1	Bottom width, <i>b</i> ₁ (ft)		<i>Q</i> _{min} ^c (ft ³ /s)	<i>Q</i> _{max} (ft ³ /s)		Crest width, <i>b</i> _c (ft)	Sill height, <i>p</i> ₁ (ft)	
(1)	(2)	(3)	(4)	(5)	(6)	(7)	(8)	(9)
1.0	1.0	2.5	1.9	8 ^d	A _e	2.0	0.50	0.06
			4.2	16 ^d	B _e	2.5	0.75	0.08
			4.8	19	C _e	3.0	1.00	0.10
			5.6	15	D _e	3.5	1.25	0.12
			6.2	11	E _e	4.0	1.50	0.13
1.0	2.0	3.0	5.6	27 ^d	D _e	3.5	0.75	0.10
			6.2	40	E _e	4.0	1.00	0.12
			6.8	33	F _e	4.5	1.25	0.14
			7.4	27	G _e	5.0	1.50	0.15
			8.2	22	H _e	5.5	1.75	0.16
1.25	1.0	3.0	5.0	19 ^d	I _e	3.0	0.8	0.08
			6.4	35	J _e	4.0	1.2	0.11
			7.6	26	K _e	5.0	1.6	0.14
1.25	2.0	4.0	6.4	31 ^d	J _e	4.0	0.8	0.10
			7.6	64 ^d	K _e	5.0	1.2	0.13
			8.9	78	L _e	6.0	1.6	0.16
			10.1	62	M _e	7.0	2.0	0.18
			11.4	46	N _e	8.0	2.4	0.20
1.5	2.0	4.0	8.	49 ^d	P _e	5.0	1.00	0.11
			9.	82 ^d	Q _e	6.0	1.33	0.13
			11.	86	R _e	7.0	1.67	0.16
			12.	72	S _e	8.0	2.00	0.18
			13.	60	T _e	9.0	2.33	0.20
1.5	3.0	5.0	9.	66 ^d	Q _e	6.0	1.00	0.12
			11.	108 ^d	R _e	7.0	1.33	0.14
			12.	140 ^d	S _e	8.0	1.67	0.17
			13.	160	T _e	9.0	2.00	0.20
			14.	140	U _e	10.0	2.33	0.22
17.	98	V _e	12.0	3.00	0.25			

NOTES:

- ^a $L_a \geq \Delta H_{1max}$; $L_b = 2$ to $3p_1$; $x = L_a + L_b > 2$ to $3 H_{1max}$
- $L > 1.5 H_{1max}$
- $d > 1.2 h_{1max} + p_1$
- $\Delta H > 0.1 H_1$

^b Maximum recommended canal depth

^c Limited by sensitivity

^d Limited by Froude number; otherwise limited by canal depth

^e Calibrations developed with WinFlume and the preceding computer models.

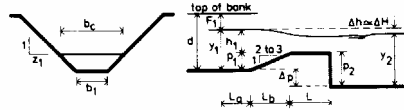


Table 8-3. — Rating equation parameters and ranges of application for flat-crested, long-throated flumes in lined trapezoidal canals^a

Parameters	Weir A _e	Weir B _e	Weir C _e	Weir D _e	Weir E _e	Weir F _e	Weir G _e
K_1	9.29	10.53	11.99	13.73	14.51	16.18	17.83
K_2	0.03	0.04	0.033	0.035	0.053	0.035	0.026
U	1.878	1.883	1.822	1.824	1.855	1.784	1.725
h_1 , min.	0.12	0.14	0.125	0.13	0.19	0.175	0.16
h_1 , max.	0.92	1.22	1.25	1.4	1.69	1.45	1.24
Q , min.	0.26	0.42	0.42	0.51	1.05	1.00	0.98
Q , max.	8.44	16.3	18.9	26.5	40.7	32.8	26.8

Parameters	Weir H _e	Weir I _e	Weir J _e	Weir K _e	Weir L _e	Weir M _e	Weir N _e
K_1	19.44	12.81	15.34	17.13	20.17	23.62	27.17
K_2	0.017	0.034	0.055	0.075	0.06	0.044	0.026
U	1.674	1.868	1.897	1.907	1.845	1.766	1.692
h_1 , min.	0.15	0.125	0.185	0.254	0.228	0.205	0.19
h_1 , max.	1.05	1.19	1.485	1.904	2.007	1.675	1.34
Q , min.	0.97	0.41	1.02	2.06	2.03	2.05	2.01
Q , max.	21.7	18.7	34.8	63.60	77.0	61.5	46.0

Parameters	Weir P _e	Weir Q _e	Weir R _e	Weir S _e	Weir T _e	Weir U _e	Weir V _e
K_1	18.95	20.96	23.94	25.61	28.13	31.29	38.44
K_2	0.05	0.07	0.056	0.072	0.072	0.062	0.034
U	1.874	1.906	1.856	1.866	1.841	1.8	1.709
h_1 , min.	0.162	0.225	0.21	0.25	0.275	0.3	0.3
h_1 , max.	1.6	2.0	2.2	2.5	2.5	2.25	1.7
Q , min.	1.0	2.0	2.1	3.1	4.0	5.0	5.9
Q , max.	48.4	83.9	108	149	160	141	98.5

^a Calibrations developed with WinFlume and preceding computer models.

$$Q = K_1(h_1 + K_2)^U$$

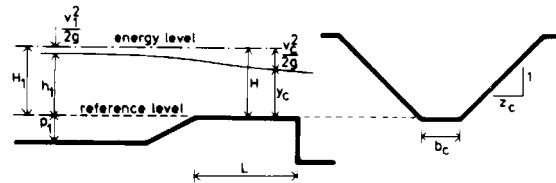


Table 8-4. — Rating equation parameters and ranges of application for flat-crested, long-throated flumes with rectangular throat sections (see Figure 8-6).

$q = K_1(h_1 + K_2)^U$ where q is the unit discharge in cubic feet per second per foot of width of the throat.
 $Q = qb_c$

Parameters	0.35 ≤ b_c ≤ 0.65 ft, $L = 0.75$ ft			0.65 ≤ b_c ≤ 1.0 ft, $L = 1.0$ ft			1.0 ≤ b_c ≤ 1.5 ft, $L = 1.5$ ft		
	$p_1 = 0.125$ ft	$p_1 = 0.25$ ft	$p_1 = \infty$	$p_1 = 0.25$ ft	$p_1 = 0.5$ ft	$p_1 = \infty$	$p_1 = 0.25$ ft	$p_1 = 0.5$ ft	$p_1 = \infty$
K_1	3.996	3.610	3.126	3.696	3.385	3.089	3.686	3.400	3.059
K_2	0	0	0	0.004	0	0	0	0	0
U	1.612	1.581	1.526	1.617	1.562	1.518	1.598	1.569	1.515
h_1 , range	0.06 – 0.46	0.06 – 0.48	0.05 – 0.5	0.08 – 0.7	0.8 – 0.7	0.08 – 0.8	0.1 – 0.9	0.1 – 1.0	0.1 – 1.0
q , range	0.04 – 1.15	0.04 – 1.14	0.03 – 1.08	0.07 – 2.1	0.07 – 1.95	0.07 – 1.8	0.09 – 3.1	0.09 – 3.4	0.09 – 3.1
ΔH	0.04	0.06	0.19	0.06	0.10	0.26	0.07	0.11	0.67

Parameters	1.5 ≤ b_c ≤ 3.0 ft, $L = 2.25$ ft				3.0 ≤ b_c ≤ 6.0 ft, $L = 3.0$ ft			
	$p_1 = 0.25$ ft	$p_1 = 0.5$ ft	$p_1 = 1.0$ ft	$p_1 = \infty$	$p_1 = 0.5$ ft	$p_1 = 1.0$ ft	$p_1 = 1.5$ ft	$p_1 = \infty$
K_1	3.662	3.375	3.19	3.036	3.362	3.169	3.167	3.027
K_2	0.008	0.011	0.009	0	0.013	0.013	0	0
U	1.643	1.625	1.587	1.514	1.636	1.605	1.557	1.519
h_1 , range	0.15 – 1.0	0.15 – 1.5	0.15 – 1.5	0.15 – 1.5	0.21 – 1.84	0.22 – 1.93	0.21 – 1.98	0.2 – 2.04
q , range	0.18 – 3.2	0.17 – 6.6	0.17 – 6.1	0.17 – 5.6	0.29 – 9.24	0.29 – 9.28	0.29 – 9.26	0.26 – 9.24
ΔH	0.07	0.13	0.2	0.5	0.13	0.22	0.29	0.63

Parameters	b_c ≥ 6.0 ft, $L = 4.0$ ft			
	$p_1 = 1.0$ ft	$p_1 = 1.5$ ft	$p_1 = 2.0$ ft	$p_1 = \infty$
K_1	3.125	3.150	3.105	2.999
K_2	0.017	0.016	0	0
U	1.621	1.575	1.563	1.521
h_1 , range	0.3 – 3.0	0.3 – 2.6	0.3 – 2.64	0.3 – 3.0
q , range	0.48 – 19	0.48 – 14.2	0.48 – 14.2	0.48 – 16
ΔH	0.25	0.33	0.40	0.85

$L_a = h_{1max}$ and $L_b = 2$ to 3 times p_1 and $L_a + L_b = 2$ to 3 times h_{1max}
 $\Delta H = 0.1H_1$, or value listed, whichever is greater, for flumes discharging into a rectangular tailwater channel of the same width as the crest, b_c
 $\Delta H = 0.4H_1$, or value listed, whichever is greater, for flumes with an abrupt expansion into a tailwater channel wider than the crest width, b_c

Table 8-5. — Equation and flow range parameters for flat-crested, long-throated flumes in partially full circular conduits (K_1 and K_2 values are valid for units of feet and ft^3/s only).

p_1/D	L_a/D	L_b/D	L/D	K_1	K_2	U	range of h_1/D	range of $Q/D^{5/2}$	b_t/D
0.20	0.50	0.60	0.700	4.176	0.007	1.750	0.080 - 0.43	0.056 - 0.980	0.800
0.25	0.60	0.75	1.125	3.970	0.004	1.689	0.070 - 0.60	0.048 - 1.689	0.866
0.30	0.55	0.90	1.050	3.780	0	1.625	0.070 - 0.55	0.050 - 1.434	0.917
0.35	0.50	1.05	0.975	3.641	0	1.597	0.065 - 0.50	0.046 - 1.202	0.954
0.40	0.45	1.20	0.900	3.507	0	1.573	0.060 - 0.45	0.042 - 0.991	0.980
0.45	0.40	1.35	0.825	3.378	0	1.554	0.055 - 0.40	0.037 - 0.807	0.995
0.50	0.35	1.50	0.750	3.251	0	1.540	0.050 - 0.35	0.032 - 0.640	1.000

Pregage distance, $L_{pg} \geq h_{max}$ Sill height = p_1
Approach, $L_a \geq h_{max}$ Dimensionless sill height = p_1/D
Converging, $L_{cv} = 3 p_1$ $h_{min} = 0.07D$
Control, $L_c \geq 1.5 D - p_1$ $h_{max} = [0.85 D - p_1]$
 $\Delta H = 0.1H_1$ for flumes with a 6:1 downstream transition
 $\Delta H = 0.2H_1$ for flumes with a vertical drop downstream from the crest

Note: The length values shown are minimum lengths in direction of flow, and may be increased 30 percent with only a slight change in calibration.

$$Q = D^{2.5} K_1 \left(\frac{h_1}{D} + K_2 \right)^U$$

Note: These values represent minimum lengths in direction of flow, may be increased 30 percent with only slight change in calibration, and should be suitable for most applications.

Besides selecting shape and size, the tables help to determine head-discharge characteristics, obtain proper measurement range, obtain sufficient sensitivity, meet the Froude number limit, and provide a final calibration.

The equation coefficients, exponents, and constants included in the tables were developed with the assumption of a known approach channel cross-sectional shape and area. However, any particular control section size and shape can be used with any approach section size and shape. But discharges must be adjusted with the approach velocity coefficient, C_v (Bos et al., 1991). The rating equations with use limits are given in design and selection tables that automatically limit the Froude number. However, if smaller approach areas are used, the designer must determine that the Froude number remains less than about 0.5.

Frequently, the site conditions may call for flumes that would have dimensions beyond the ranges provided by the ratings in this chapter. To extend beyond these limits and for further information, refer to Bos et al. (1991), Clemmens et al. (1993), Ackers et al. (1978), and Bos (1989). The designer has the option of designing a flume shape or size not presented here by using the theoretically based computer program (Clemmens et al., 1987; 1993).

(a) Long-Throated Flumes for Lined Trapezoidal Channels

Pre-computed calibration tables for selected long-throated trapezoidal flumes suitable for use in some common canal sizes are included in tables 8-2 and 8-3. In selecting these standard canal sizes and slopes and their related flow rates for these design tables, consideration was given to proposals by the International Commission on Irrigation and Drainage (ICID), to the construction practices of the Bureau of Reclamation, and to design criteria for small canals used by the United States Natural Resources Conservation Service (formerly the Soil Conservation Service) (Bos et al., 1991).

Present practice dictates side slopes of 1:1 for small, monolithic, concrete-lined canals with bottom widths less than about 3 ft, and depths less than about 3 to 4 ft. Deeper and wider canals tend toward side slopes of 1.5 horizontal to 1 vertical. When the widths and depths are greater than about 10 ft, the trend is more toward 2:1 side slopes. This trend is particularly observed if canal operating procedures may allow rapid dewatering of the canal. In some soil conditions, rapid dewatering can cause hydrostatic pressures on the underside of the canal walls that lead to wall failure. Most of the lined canals used in a tertiary irrigation unit or on large farms are of the smaller size. They have 1- to 2-ft bottom widths, 1:1 side slopes, and capacities below 35 ft³/s.

Standard sizes and precalibrations are given in tables 8-2 and 8-3 so that the designer may select one of these structures to be built into an existing lined channel as shown on [figure 8-5](#). The designer need only select a weir width with its corresponding sill height. Standard bottom ramp-flat crest combination flumes in typical slip-formed canals were selected for precalibrations.

Table 8-2 gives pre-computed flume selections for trapezoidal canals with bottom widths of 1, 2, and 3 ft. Canal sizes with bottom widths in excess of 3 ft are omitted in the pre-computed design tables on the assumption that larger sizes deserve special design consideration and should be computer designed and calibrated using accessible programs such as those provided in Clemmens et al. (1993).

Table 8-2 provides a number of pre-computed flumes that may be used for the various combinations of bottom widths and sidewall

slopes as given in the first two columns. The third column lists recommended values of maximum canal depth, d , for each side-slope and bottom-width combination.

The offering of many pre-computed sizes will aid in retrofitting older canal systems and yet not prevent the adoption of standard sized canals as proposed by other agencies and international bodies, such as the Natural Resources Conservation Service, U.S. Department of Agriculture (USDA), and the ICID.

For each combination of bottom and side slope, several standard crest sill heights can be used (column 8 in table 8-2). Columns 4 and 5 give the limits on discharge for each canal-flume combination. These limits on canal capacity originate from three sources:

- (1) The Froude number, equation 2-25, in the approach channel, is limited to less than 0.5 to assure water surface stability.
- (2) The canal freeboard, F_b , upstream from the structure, should be greater than 20 percent of the upstream sill-referenced head, h_1 . In terms of canal depth, this limit is $d \geq (p_1 + 1.2h_{1\max})$.
- (3) The sensitivity of the flume at maximum flow should be such that a 3/8-in change in the value of the sill-referenced head, h_1 , causes less than a 10-percent change in discharge.

Also indicated in the last column of table 8-2 is a minimum head loss, ΔH , that the structure must provide. Excessive downstream water levels may prevent this minimum head loss, which means that the structure exceeds its modular limit or submergence limit and no longer functions as an accurate measuring device.

When flumes are placed in irrigation canals, the downstream channel is similar to the upstream channel, and the modular limit range for a flume with no expansion section of 72 to 93 percent for low flow to high flow is appropriate. The tables presented herein for long-throated flumes and broad-crested weirs are based on this assumption, except that the upper limit is conservatively reduced to 90 percent.

Thus, the design head loss is either $0.1 h_1$ or the listed value for ΔH , whichever is greater. For these tables, it was assumed that the weir was placed in a continuous channel with a constant cross section. Technically, this limit of submergence is based on the total energy drop through the structure, but the velocity head component is usually of the same order of magnitude upstream and downstream so that Δh may be satisfactorily substituted for ΔH .

Table 8-2 is primarily intended for the selection among these structures. It is also useful for the selection of canal sizes. The Froude number in the canal is automatically limited to 0.5. Selecting the smallest canal for a given capacity will give a reasonably efficient section. For instance, if the design capacity of the canal is to be $35 \text{ ft}^3/\text{s}$, the smallest canal that can be incorporated with a measuring flume has $b_1 = 2 \text{ ft}$, $z_1 = 1.0$, and $d = 3 \text{ ft}$.

Each standard flume can be used for a range of bottom widths because the change in flow area upstream from the structure causes only a small change in velocity of approach and a

corresponding small change in energy head. The width ranges have been selected so that the error in discharge caused by the change in flow area is less than 1 percent. This is a systematic error for any particular approach channel size, and the extent of this error varies with discharge. However, the width of the crest must match the table dimension value.

A flume suitable for several of the listed canal bottom widths is also suitable for any intermediate width. For example, in table 8-2, structure E_e can be used in canals with bottom widths between 1 and 2 ft; for example, $b_1 = 1.25$ ft. The user will need to determine the sill height to match b_c , head loss, and maximum design discharge for these intermediate sizes.

The rating equation coefficients and constants for the flumes are given in table 8-3 and will reproduce the values presented in the original calibration tables produced by computer modeling (Bos et al., 1991) to within about ± 1 percent. The original tables were computed using the following criteria and the symbols on [figure 8-5](#):

- (1) Each flume has a constant bottom width, b_c , and a sill height, p_1 , that varies with the canal dimensions.
- (2) The ramp length can be chosen such that it is between 2 and 3 times the sill height. The 3:1 ramp slope is preferable.
- (3) The gage is located a distance equal to at least maximum total head, H_{1max} , upstream from the toe of the ramp. In addition, the gage should be located a distance of roughly 2 to 3 times H_{1max} from the entrance to the throat.
- (4) The throat length should be at least 1.5 times the maximum expected sill referenced measured head, h_{1max} , but should be within the limits indicated in table 8-2.
- (5) The canal depth must be greater than the sum of $(p_1 + h_{1max} + F_b)$, where F_b is the freeboard requirement, which is roughly 0.2 times the sill referenced maximum measured head, h_{1max} .

Occasionally, a flume cannot be found from these design tables that will work satisfactorily. The user must then judge and select between several options; for example:

- (1) Find a new site for the structure with more vertical space.
- (2) Add to the canal wall height upstream from the site so that more backwater effect can be created.
- (3) Try one of the other shapes.
- (4) Use the design tables to interpolate and get a rating for an intermediate width, probably with some sacrifice in accuracy.
- (5) Produce a special design using the computer model.

(b) Long-Throated Flumes for Unlined Channels

Measurement flumes for earthen (unlined) channels require a structure that contains the following basic parts: entrance to approach channel, approach channel, converging transition, throat, diverging transition, stilling basin, and riprap protection. As illustrated on figure 8-6, the discharge measurement structure for an earthen channel is longer, and thus more expensive, than a structure in a concrete-lined canal ([figure 8-5](#)). In the latter, the approach channel and sides of the control section already exist, and the riprap is not needed.

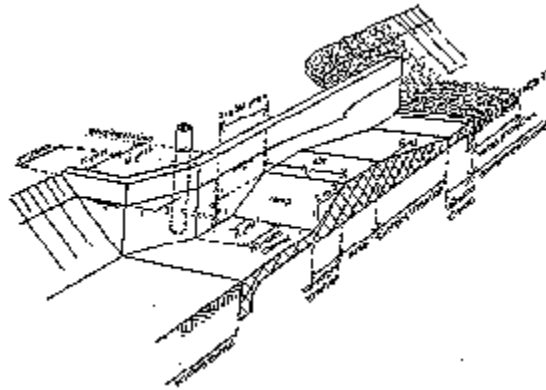


Figure 8-6 -- Flow measurement structure for earthen channel with a rectangular control section.

For earthen canals, the designer selects both structure flow width and a sill height and must be more aware of the other design considerations. For lined channel design, only the sill height must be selected.

If the upstream sill-referenced head is not measured in a rectangular approach canal of this same width, but instead is measured in the upstream earthen section, then these tables require correction to the discharge, Q , for the change in the approach velocity. The tables and equations can also be used to determine the rating for side-contracted rectangular flumes. Procedures needed to handle and correct for change of velocity of approach are given in Bos (1989), Bos et al. (1991), and Clemmens et al. (1993). Throat lengths for side contractions appear to work best if they exceed about 2 times the throat width.

The full-length structure of figure 8-6 can be simplified by deleting the diverging transition (downstream ramp) or the entire extended rectangular tailwater channel. These changes will increase the head loss across the structure and force energy dissipation to take place within the earthen canal section. The extended tailwater section of the structure may be deleted only if adequate riprap is provided and if the Froude number in the tailwater channel is less than 1.7 at maximum flow (Bos et al. 1991).

The approach canal of figure 8-6 provides a known flow area and velocity of approach. The coefficients and constants for rating equations for the rectangular flumes given in table 8-4 assume that the approach section is rectangular and has the same width as the throat.

The rectangular measurement flume discharges nearly equal quantities of water over equal widths. The major differences are associated with the friction along the walls. Thus, the flow is nearly two-dimensional along the crest, so rating tables can provide the unit flow rate, q , in cubic feet per second per foot width of crest for each value of h_1 . This allows a wide variety of sizes for rectangular long-throated structures. For each width, b_c , of the structure, an accurate rating table can be developed by multiplying the design table discharges by b_c :

$$Q = b_c q \quad (8-1)$$

The equation, coefficients, and exponents for a series of rectangular flat-crested, long-throated flumes given in table 8-4 were developed from computer modeled tables given in Bos et al. (1991). The equation will reproduce those computer-derived table values to within ± 1.5 percent. The equation coefficients and exponents are given for sets of p_1 or crest heights. However, interpolation between crest heights gives reasonable results. Small groupings of structure widths were averaged to keep sidewall effect error to within 1 percent. Overall accuracy of rectangular long-throated flumes can be between 2 and ± 5 percent, depending on how accurately water levels are measured. Overall accuracy of ± 2 percent is possible but requires calibration by the computer program of Clemmens et al. (1993) and sensitive stilling well water level measurements.

If the approach area, A_1 , is larger than that used to develop these rating design tables, either because of a higher sill or a wider approach channel, the ratings must be adjusted for C_v . To simplify this process, the discharge over the structure for a C_v value of 1.0 is given in the far right column of each grouping. This column is labeled $p_1 = \textit{infinity}$ because that would cause the approach velocity of zero, and C_v would be 1.0. This scenario approximates a structure at the outlet of a reservoir or lake. The complete correction procedure is given in Bos (1989), Bos et al. (1991), and Clemmens et al. (1993).

The design procedure for lined rectangular canals is relatively straightforward. It consists of selecting a table crest height, p_1 , that causes modular flow throughout the discharge range and provides sufficient freeboard at the maximum discharge. An appropriate width must be chosen for unlined canals. Several widths will usually work. Extremely wide, shallow flows are subject to measurement errors because of low head detection sensitivity. Extremely narrow, deep flows require long structures and large head losses.

Because of the wide variety of shapes that can be encountered in earthen channels and in the range of discharges to be measured, determining the interrelated values of h_{1max} , p_1 , and b_c of the structure is complicated. Although this difficulty complicates the design process, it allows the designer greater flexibility and expands the applicability of the flumes. The following criteria should be considered by the designer:

- (1) The discharges to be measured (per foot of width) must be within the range of discharges shown in the table for the selected structure if the dimensions in the tables are to be used.
- (2) The needed or selected allowable combined measurement error should be checked and not exceeded. The allowable error may vary for different flow ranges (Bos et al., 1991; Clemmens et al., 1993).

- (3) Sufficient head loss should be available across the structure at all flow rates. If there is an abrupt expansion (no downstream ramp) into a rectangular channel the same width as the crest, the head loss should be the greater of $0.1H_1$ or the value shown in table 8-4. If the downstream channel is wider than the crest, the head loss should be at least $0.4H_1$.
- (4) Placing a structure in the canal should not cause overtopping upstream.
- (5) A uniform, straight, and unobstructed approach channel section of 10 times the channel width should precede the structure.
- (6) The Froude number, as defined in chapter 3, should not exceed 0.5 for a distance of at least 30 times h_1 upstream from the structure.

Following these criteria will allow the designer to select a satisfactory structure that will operate as intended.

For a rectangular long-throated flume in an earthen canal, the rectangular section need not extend 10 times its width upstream from the structure if a gradual taper is used to guide the flow into the rectangular section. For the structures given here, it is recommended that the rectangular section extend upstream from the head measurement location (gaging station) as shown on figure 8-6. It is also recommended that well-designed protective riprap be placed downstream from the structure for a distance of four times the maximum downstream channel flow depth, y_{2max} (figure 8-6). A step should be provided at the downstream end of the structure just before the riprap section to avoid local erosion from floor jets. Sizing of riprap and filters is discussed by Bos (1989) and Bos et al. (1991).

A freeboard criteria of $0.2 h_{1max}$ has been used satisfactorily for lined channels. For unlined channels, it may be more appropriate to specify a maximum approach flow water depth, y_{1max} . The downstream water depth, y_2 , needs to be checked and must not exceed the submergence or modular limit for both the minimum and maximum expected discharge.

If the channel is rectangular or the length of the rectangular-throated flume downstream from the crest end is as on figure 86, then $0.1 H_1$ or the ΔH value given at the bottom of table 8-4 can be used as the lower value of minimum required total head loss, ΔH . If a shorter length in an earthen channel is used and the tailwater channel is significantly larger than the stilling basin would be, then considerably more head loss will probably be required. The designer should use the head loss value for the discharge into a lake or pool, $\Delta H = 0.4 H_1$. This value may represent a drastic difference in the value of head loss. The designer may decide to use the shortened structure and calculate the actual modular limit by use of the computer model (Bos et al., 1991). Another alternative is to build a prototype in the field and set the crest to the appropriate level by trial and error.

(c) Measuring Flow in Circular Conduits Partly Full

As previously mentioned, long-throated flumes for circular conduits are convenient for use as portable and permanent measurement structures. Bottom ramps followed by flat crests or sills

can be used in circular conduits. These flumes (figure 8-7) are usually placed in the conduit at a crest height from 0.2 to 0.5 times the pipe diameter in height. The open channel depth limit in the conduit is about 0.9 times the approach conduit diameter.

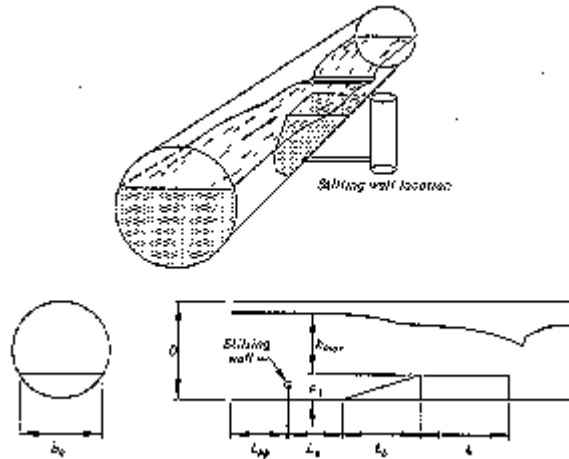


Figure 8-7 -- Long-throated flume in a partially filled circular conduit.

General methods of computing calibrations for long-throated flumes in circular conduits and selected construction configurations were developed using the computer model described in Clemmens et al. (1993).

The precalibrated selections given in table 8-5 are for average roughnesses of construction materials and are based on curve-fitted equations of computed discharge tables in English units for dimensions proportioned in terms of pipe diameter. Calibration equations for other pipe diameters can be approximated using Froude modeling relationships, which produce the following equation:

$$Q = (D)^{2.5} K_1(h_1/D + K_2)^U \quad (8-2)$$

where:

Q = discharge, ft³/s

D = diameter of pipe, ft

K_1 = constant from table 8-5

K_2 = constant from table 8-5

h_1 = head measured from sill top (bottom of contracted section), ft

U = Exponent

Precalibrated flumes represented in table 8-5 are subject to Froude scaling. These and all the long-throated flume shapes can be similarly scaled without using the computer model as long as all dimensions remain proportional. Small differences from direct computer results are to be expected because roughness of construction materials is not usually scaled. Smooth concrete roughness was used to develop the values in table 8-5. The calibration equations, coefficients, constants, and exponents for the equation from table 8-5 will usually produce calibrations within ± 3 percent of discharge, not counting the error of head measurement, for scaling ratios between

1:5 and 5:1. Scaling expansion by 10 tends to overemphasize roughness and will underpredict discharge by 5 to 10 percent. Accuracy within ± 2 percent requires individual computation of the constructed device using the constructed dimensions in the computer model of Clemmens et al. (1993).

As with the other broad-crested weirs and long-throated flumes, the width of the flat crest or sill surface, b_c , is one of the two most important dimensions in the flume. The other is the zero elevation of the head measuring device.

For portable measurements, it is recommended to translocate the water surface to a small stilling well overhanging the crest at the head reference location. Thus, the translocated head in the stilling well is conveniently referenced to the crest without the necessity of surveyor leveling of the structure (Bos et al., 1991). The measuring head and crest elevation can both be measured by the same point gage. The upstream gage should be used only if it is accurately leveled or is part of a permanently installed flume.

For example:

A circular concrete culvert 4 ft in diameter and 20 ft long is to be converted into a measuring structure. The outlet ends in an overfall so that a minimum sill height of $0.2D$ is useable. Develop the calibration equation using table 8-5, and sketch the installation dimensions.

Using equation 8-2 and table 8-5 gives:

$$Q = (D^{5/2})K_1(h_1/D + K_2)^U$$

$$\text{or: } Q = (4)^{5/2} 4.13 (h_1/4 + 0.004)^{1.736}$$

$$\text{or: } Q = 132.2(h_1/4 + 0.004)^{1.736}$$

$$\text{for an } h_1 \text{ range of: } 0.08 D \leq h_1 \leq 0.65D$$

$$\text{or: } 0.32 \leq h_1 \leq 2.6$$

$$\text{and a } Q \text{ range of: } 0.056 D^{5/2} \leq Q \leq 1.975D^{5/2}$$

$$\text{or: } 1.792 \leq Q \leq 63.2$$

The modular or submergence limits should be checked and should not exceed $0.8h_1$ if a vertical drop exists at the end of the downstream crest and should not exceed $0.9h_1$ if a 1:6 horizontal sloping ramp downstream is added such as shown on figure 8-6. These modular limits are equivalent to minimum required head loss to measure flow of $0.2h_1$. All flow rates to be measured should be checked for exceeding the modular limit.

A stilling well can be placed in the channel if it does not significantly obstruct flow or divert flow to a far bank and cause erosion. Placing the stilling well in the upstream channel often causes detrimental flow patterns that can affect the function of the flow measuring device, unless it is dug deep into the bank or placed a substantial distance upstream.

Represented on figure 8-8 is a static pressure tube consisting of several 1/8-in-diameter holes drilled into 1-in polyvinylchloride pipe used as a head measurement pickup. These holes are

located about 2 ft from the end of the capped pipe so that flow separation around the end of the pipe is neutralized by the time the flow passes the pressure sensing holes. The water level sensed here is transmitted to the stilling well where the depth can be observed by any of the several methods discussed in section 7 of this chapter.

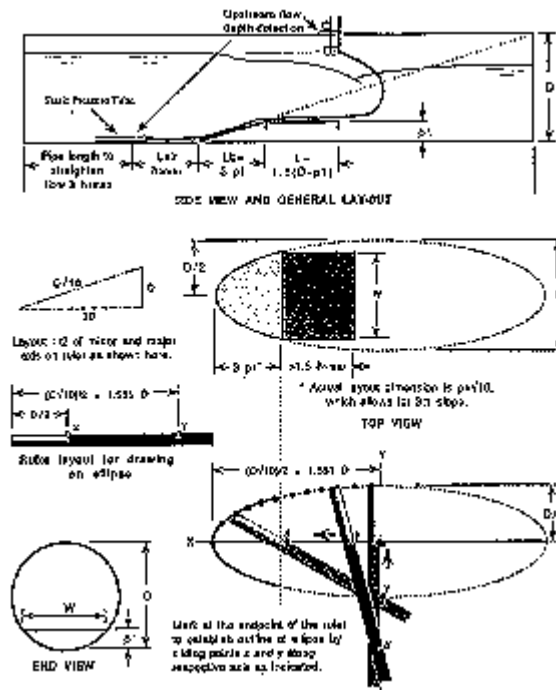


Figure 8-8 -- Layout scheme for portable long-throated measurement structures in partially full circular conduits.

Note that the sensing holes are well above the floor of the channel, which should reduce sediment plugging. Also, note that the sensing pipe is clamped tightly to the wall of the culvert so that debris trapping is minimized. The area obstruction of the pipe crossing the sill control area is small and can be ignored.

(d) Constructing Portable Long-Throated Flumes for Circular and Semicircular Conduits

A $0.2D$ sill height is commonly selected for semicircular conduits. For either semicircular or complete pipes, the sloping ramp can be fabricated from sheet materials such as galvanized steel, stainless steel, aluminum, or marine plywood. A suggested method for layout of the necessary portion of an ellipse is illustrated on figure 8-8.

10. Parshall Flumes

Although Parshall flumes are in extensive use in many western irrigation projects, they are no longer generally recommended because of the advantages of long-throated flumes previously cited and the disadvantages of Parshall flumes to be subsequently discussed. Some states specify the use of Parshall flumes by law for certain situations.

In the past, it was common to size and set flumes for 95-percent submergence to reduce approach flow depths 4 to 6 in. The 1976 second edition of this manual gives detailed examples of

selecting size and setting crest elevation for free flow and intended submergence. Although correction methods for determining submerged discharge exist, designing flumes for submerged flow measurement is no longer considered good design practice because it compromises accuracy. For example, imprecision of head measurement increases discharge error by 4 to 20 percent over the primary free-flow accuracy of 3 to 5 percent. In addition, a recent study (Peck, 1988) found a 12-percent discontinuity in the submergence correction function for a 1-ft flume depending upon whether downstream measuring head results from a falling or rising water surface.

Designing and setting Parshall flumes for submerged flow measurement is not usually recommended because less expensive, long-throated flumes can be designed that approach or exceed 90 percent submergence limits with a single upstream head measurement. Moreover, the absolute required drop in water surface is usually less for the long-throated flumes, particularly the modified broad-crested weir styles.

Because so many Parshall flumes are currently in use, the remaining part of this section is concerned mainly with structural dimensions for checking existing flumes, equations for computing discharges, free-flow discharge tables for each size flume, plots for submerged discharge measurement corrections, and head loss curves for assessing upstream depth changes caused by downstream delivery depth changes.

Care must be taken to construct Parshall flumes according to the structural dimensions given on figure 8-9. This factor becomes more important as size gets smaller. The portion of the flume downstream from the end of the converging section need not be constructed if the flume has been set for free flow where it is not expected to operate above submergence limit. This truncated version of the Parshall flume is sometimes referred to as the Montana flume.

Submergence corrections or discharge cannot be determined for Montana flumes or other modified Parshall flumes because they do not include the part of the full Parshall flume where the submergence head, h_b , was measured during calibration. Different size Parshall flumes are not geometrically proportional. For example, a dimension in the 12-ft flume cannot be assumed to be three times the corresponding dimension in the 4-ft flume. Each of the flumes on figure 8-9 is a standard device and has been calibrated for the range of discharges shown in the table. The flumes can reliably measure free-flow discharge to within "3 to "5 percent, plus head detection error, if standard dimensions are attained during construction, the flume is correctly set, and the flume is operated and maintained according to the recommended procedures.

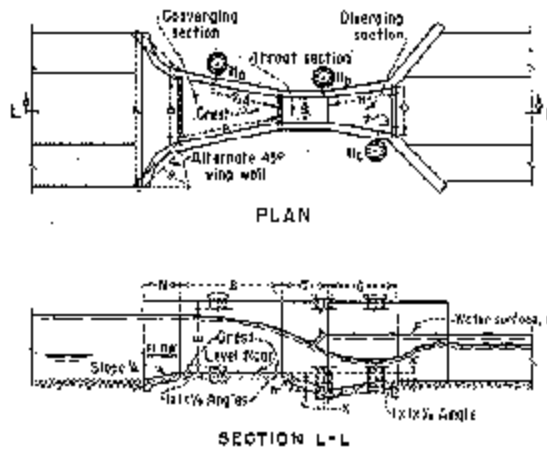


Figure 8-9 -- Parshall flume dimensions -- sheet 1 of 2 (courtesy of U.S. Natural Resources Conservation Services).

W	H	C	L	F	D	T	R	L	H	Q	Q _{min}
1	1.0	0.2	1.0	0.1	0.1	0.1	0.1	0.1	0.1	0.03	0.03
2	2.0	0.2	2.0	0.1	0.1	0.1	0.1	0.1	0.1	0.1	0.1
3	3.0	0.2	3.0	0.1	0.1	0.1	0.1	0.1	0.1	0.1	0.1
4	4.0	0.2	4.0	0.1	0.1	0.1	0.1	0.1	0.1	0.1	0.1
5	5.0	0.2	5.0	0.1	0.1	0.1	0.1	0.1	0.1	0.1	0.1
6	6.0	0.2	6.0	0.1	0.1	0.1	0.1	0.1	0.1	0.1	0.1
7	7.0	0.2	7.0	0.1	0.1	0.1	0.1	0.1	0.1	0.1	0.1
8	8.0	0.2	8.0	0.1	0.1	0.1	0.1	0.1	0.1	0.1	0.1
9	9.0	0.2	9.0	0.1	0.1	0.1	0.1	0.1	0.1	0.1	0.1
10	10.0	0.2	10.0	0.1	0.1	0.1	0.1	0.1	0.1	0.1	0.1
15	15.0	0.2	15.0	0.1	0.1	0.1	0.1	0.1	0.1	0.1	0.1
20	20.0	0.2	20.0	0.1	0.1	0.1	0.1	0.1	0.1	0.1	0.1
25	25.0	0.2	25.0	0.1	0.1	0.1	0.1	0.1	0.1	0.1	0.1
30	30.0	0.2	30.0	0.1	0.1	0.1	0.1	0.1	0.1	0.1	0.1
40	40.0	0.2	40.0	0.1	0.1	0.1	0.1	0.1	0.1	0.1	0.1
50	50.0	0.2	50.0	0.1	0.1	0.1	0.1	0.1	0.1	0.1	0.1

Figure 8-9 -- Parshall flume dimensions -- sheet 2 of 2 (courtesy of U.S. Natural Resources Conservation Services).

Parshall flume sizes are designated by the throat width, W , and dimensions are available for flumes from the 1-in size for free flow of $0.03 \text{ ft}^3/\text{s}$ at 0.2 ft of measuring head up to the 50-ft size with $3,000 \text{ ft}^3/\text{s}$ at a head of 5.7 ft. The free-flow discharge range and dimensions for Parshall flumes are given on figure 8-9. The minimum flows in this table up to the 1-ft-size flume are for a head of 0.2 ft because measuring at smaller heads results in imprecision of head measurement and surface tension effects. The remaining discharge limits are based on the range of the calibration data and practical size considerations.

(a) Free-Flow Discharge Tables and Equations

Parshall flumes were calibrated empirically to generate the free-flow head versus discharge rating for the 1-in to 50-ft flumes. Some of the larger sizes were not directly calibrated but were scale modeled. The free-flow discharge equations for the standard Parshall flume sizes are of the form:

$$Q = Ch_a^n \quad (8-3)$$

where:

h_a = measuring head (ft) Q = discharge (ft³/s) C and n for each size are given in table 8-6

Head versus discharge is given in [tables A8-7 through A8-21](#) for all sizes (see appendix).

Table 8-6

Coefficients (C) and exponents (n) for Parshall flumes for equation 8-3

Throat width	Coefficient (C)	Exponent (n)
1 in	0.338	1.55
2 in	0.676	1.55
3 in	0.992	1.55
6 in	2.06	1.58
9 in	3.07	1.53
1 ft	3.95	1.55
2 ft	8.00	1.55
3 ft	12.00	1.57
4 ft	16.00	1.58
5 ft	20.00	1.59
6 ft	24.00	1.59
7 ft	28.00	1.60
8 ft	32.00	1.61
10 ft	39.38	1.60
12 ft	46.75	1.60
15 ft	57.81	1.60
20 ft	76.25	1.60
25 ft	94.69	1.60
30 ft	113.13	1.60
40 ft	150.00	1.60
50 ft	186.88	1.60

(b) Submerged Flow Determination

Calibration tests show that the discharge at a given upstream measuring head is not reduced until the submergence ratio, h_b/h_a (submergence head to measuring head) expressed in percent, exceeds the following values:

50 percent for flumes 1, 2, and 3 in wide

60 percent for flumes 6 and 9 in wide

70 percent for flumes 1 to 8 ft wide

80 percent for flumes 8 to 50 ft wide

These submergence limits are based on two measuring head locations shown in figure 8-9 within the structure and do not measure all the head loss caused by the flume. Thus, these limits do not represent the total required head loss needed to measure flow with one head measurement. The method of determining submerged flow discharge varies with different flume size groups. Examples are provided later.

(1) Submerged Flow in 1- Through 3-Inch Flumes

Submergence begins to reduce the discharge through the 1-, 2-, and 3-in flumes when it exceeds 50 percent. To determine discharges for submerged flows, the heads h_a and h_b are used with figures 8-10, 8-11, and 8-12. Users found they had difficulties in obtaining field readings of h_a because of wave interference. To solve this problem, figure 8-13 was developed to relate h_b to h_c , which is located at the downstream end of the flume divergence where the water surface is smoother.

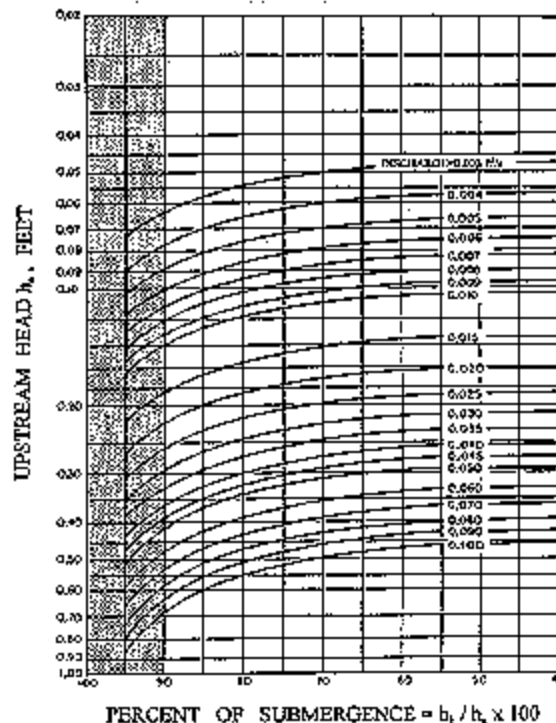


Figure 8-10 -- Rate of submerged flow through a 1-in Parshall flume (Robinson, 1957).

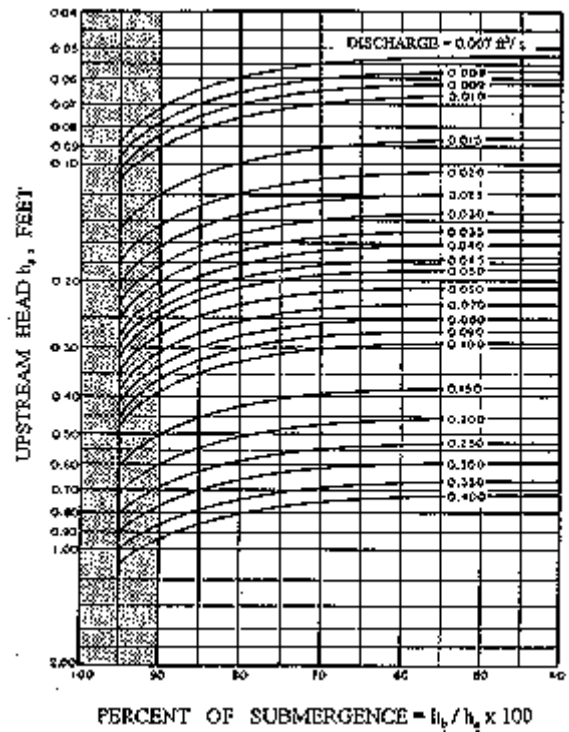


Figure 8-11 -- Rate of submerged flow through a 2-in Parshall flume (Robinson, 1957).

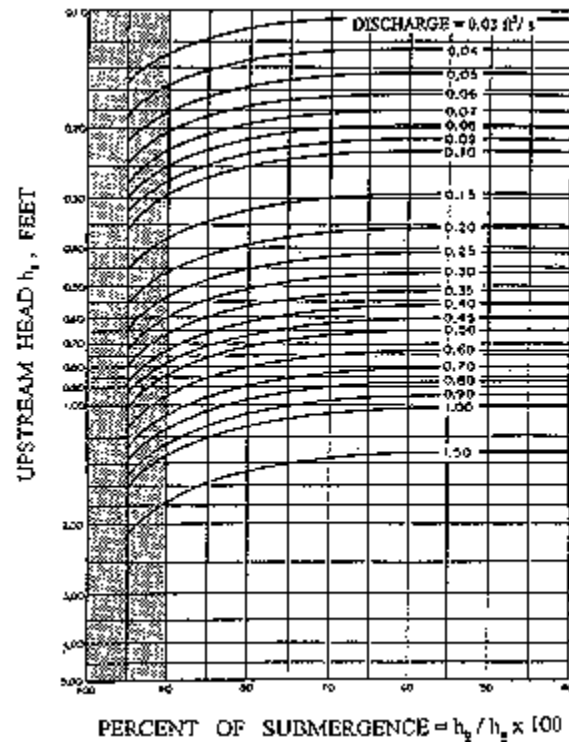


Figure 8-12 -- Rate of submerged flow through a 3-in Parshall flume (Robinson, 1957).

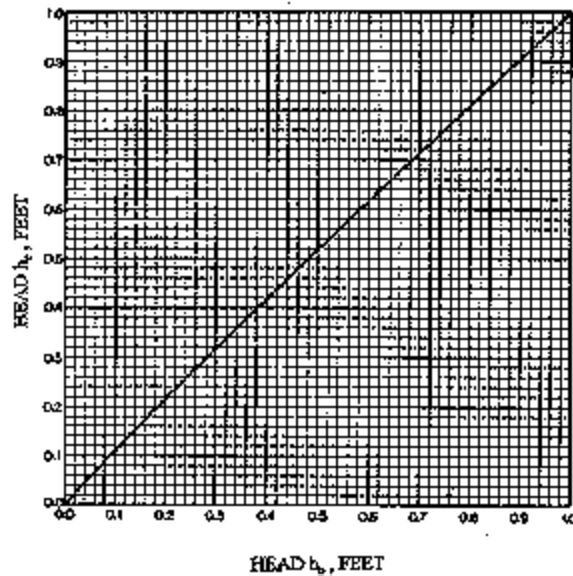


Figure 8-13 -- Relationship of h_c and h_b gages for 1-, 2-, and 3-in Parshall flumes for submergence greater than 50 percent (Robinson, 1957).

In a 3-in flume, assume h_a of 0.20 ft and the downstream head measured at the h_c gage is 0.19 ft. To determine the discharge, turn to the curve on figure 8-13, which shows the relationship of h_c to h_b . For a value of h_c equal to 0.19, h_b is found to be 0.17. The submergence, $h_b/h_a = 0.17/0.20 = 0.85$ or 85 percent.

Enter figure 8-12 with the value of the upstream head, h_a , of 0.20 and move horizontally to the right to the vertical line for h_b/h_a of 85 percent. This intersection point lies about seven-tenths of the distance from the curved discharge line for $0.06 \text{ ft}^3/\text{s}$, toward the $0.07 \text{ ft}^3/\text{s}$ line. The interpolated discharge value is $0.067 \text{ ft}^3/\text{s}$. This rate of flow for submerged conditions is considerably less than the free-flow discharge value of $0.082 \text{ ft}^3/\text{s}$ for h_a of 0.20 ft. As mentioned previously in section 7 of this chapter, correcting for submergences greater than 90 percent does not provide reliable accuracy.

(2) Submerged Flow Determination With 6- and 9-Inch Flumes

When 6- and 9-in flumes are operating with submergences greater than 60 percent, the discharge is directly determined using figures 8-14 and 8-15, respectively. For example, determine the discharge through a 6-in flume when h_a is 1.32 ft and h_b is 1.20 ft. The submergence ratio, 1.20 divided by 1.32, is 0.91, or 91 percent. On figure 8-14, find 91 percent along the left-hand vertical scale and follow the 91-percent line horizontally to intersect the curved line for h_a , which is 1.32 (one-fifth the distance between the 1.3 and 1.4 lines). Then move vertically downward from this point to the scale at the base of the diagram and find that the submerged rate of flow is $2.02 \text{ ft}^3/\text{s}$. As mentioned previously in section 7 of this chapter, correcting for submergences greater than 90 percent does not provide reliable accuracy.

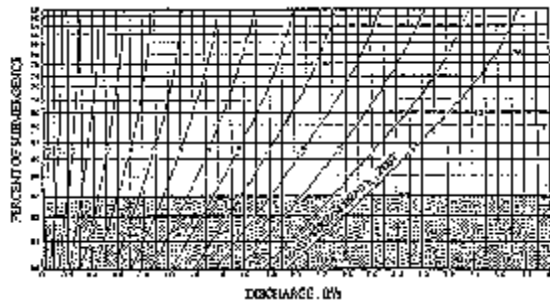


Figure 8-14 -- Diagram of determining rate of submerged flow for a 6-in Parshall flume (courtesy of U.S. Natural Resources Conservation Service).



Figure 8-15 -- Diagram for determining rate of submerged flow for a 9-in Parshall flume (courtesy of U.S. Natural Resources Conservation Service).

(3) Submergence Correction for 1- to 8-Foot Flumes

The submergence corrections that must be subtracted from the free-flow values in [table A8-12](#) to obtain submerged flow values in a 1-ft flume are shown on figure 8-16. For example, in a 1-ft flume with h_a of 1.00 ft, the discharge from [table A8-12](#) is 4.00 ft³/s. If h_b is measured to be 0.8, the submergence, h_b/h_a , is equal to 80 percent. If figure 812 for h_a is 1.00 and submergence is 80 percent, the correction is 0.35 ft³/s. Therefore, submergence would result in a reduction in discharge of 0.35 ft³/s or an actual discharge of 3.65 ft³/s, compared to a free-flow discharge of 4.00 ft³/s.

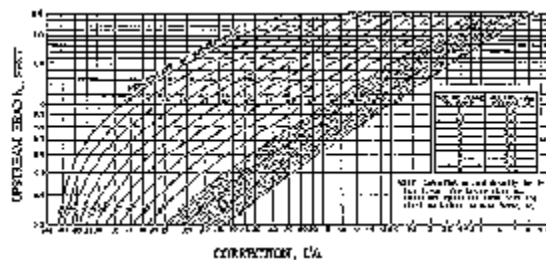


Figure 8-16 -- Diagram for determining correction to be subtracted from free discharge to obtain rate of submerged flow for 1- through 8-ft Parshall flumes.

Submergence correction values for 1- to 8-ft flumes are obtained from figure 8-16, but the procedures contained in the note in the figure must be followed.

These procedures state that values read from the curve are multiplied by the M values listed in the table on figure 8-16 for each size to obtain the product or correction to subtract from the free discharge values.

For example, assume that submerged flow occurs in a 3-ft flume where h_a is 2.10 ft and h_b is 1.89 ft. The submergence ratio, 1.89 divided by 2.10, is 0.90, or 90-percent submergence. The free-flow discharge for a 3-ft flume with h_a of 2.10 is found from [table A8-12](#) to be 38.4 ft³/s. On figure 8-16, h_a is 2.10 and submergence is 90 percent: a correction of 3.5 ft³/s. However, this correction is only for a 1-ft flume. For a 3-ft flume, the correction must be multiplied by 2.4 (from tabulation on figure 8-16) to get the total correction of 8.4 ft³/s. The corrected submerged discharge is, therefore, 38.4 minus 8.4, or 30.0 ft³/s. As mentioned previously in section 7 of this chapter, correcting for submergences greater than 90 percent does not provide reliable accuracy.

(4) Submergence Correction for 10- to 50-Foot Flumes

The submergence ratio, h_b/h_a , expressed in percent, and the h_a value are used on figure 8-17 to obtain the correction to be subtracted from the free-flow discharge determined from [tables A8-12 through A8-20](#).

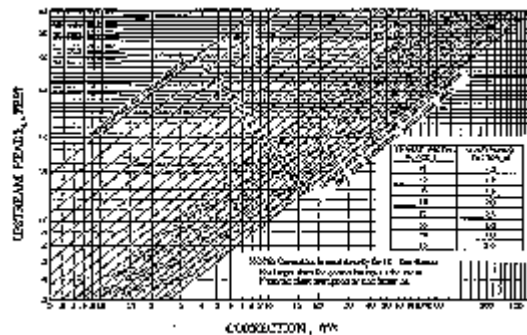


Figure 8-17 -- Diagram for determining correction to be subtracted from free discharge flow to obtain submerged flow discharges through 10- to 50-ft Parshall flumes (Parshall 1953).

The correction values, indicated along the base of the diagram on figure 8-17, give the number of cubic feet per second to be subtracted for each 10 ft of crest width, W . To aid in determining the multiplying factor, a tabulation has been incorporated on figure 8-17.

Thus, to determine the discharge for submerged flow through a 20ft flume when h_a is 3.25 ft and h_b is 3.06 ft, first determine the submergence ratio:

$$\frac{h_b}{h_a} = 0.941 = 94.1\%$$

Enter at the left side of the diagram of figure 8-17, and at h_a equals 3.25, project a horizontal line to intersect the 94-percent line, then continue on to one-tenth of the distance between the 94- and 95per-cent lines. Vertically below this point on the horizontal scale is the correction value, 56 ft³/s. For a 20-ft flume, the multiplying factor is 2.0 (from tabulation on figure 8-17), and the total correction is:

$$2.0 \times 56 = 112 \text{ ft}^3/\text{s}$$

The free discharge value from [table A8-16](#) for h_a of 3.25 is about 503 ft^3/s . Therefore, the submerged flow is 503 minus 112, or 391 ft^3/s . As mentioned previously in section 7 of this chapter, correcting for submergences greater than 90 percent does not provide reliable accuracy.

(c) Head Loss Determination

Flumes are obstructions that produce backwater that extends upstream from the flume and raises the water surface in the approach channel. This difference in elevation of the flow upstream from the structure with and without the flume in place is the head loss caused by the flume. The difference in measuring heads is not the head loss of Parshall flumes.

Downstream channel depth-discharge relationships often change with changes of downstream flow resistance, which frequently varies with sediment deposits, debris, canal checking operations, and aging. Downstream changes in flow resistance plus head loss can cause overtopping of upstream approach channel banks. Thus, irrigation system managers that have Parshall flumes need to determine head losses.

(1) Head Loss for 10- to 50-Foot Throats

The increase in depth upstream from the structure or the head loss for the 10- to 50-ft flume is determined using figure 8-18. For example, assume a 20-ft flume is set 1.4 ft above the bottom of the channel, is discharging 950 ft^3/s , and is at 90-percent submergence. The head loss from figure 8-18 is obtained by following the vertical 90-percent submergence line up to the curved discharge line for 950 ft^3/s , projecting a horizontal line to the sloping 20-ft throat line, and coming vertically down to the head loss scale reading of 0.9 ft.

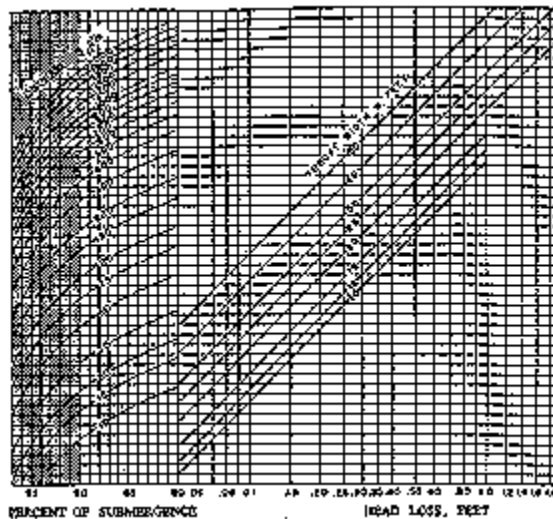


Figure 8-18 -- Head loss through 10- to 50-ft Parshall flumes (Parshall 1953).

(2) Head Loss for 1- to 8-Foot Throats

The head loss values for flumes 1 to 8 ft wide can be determined from figure 8-19. For example, assume a 4-ft flume which has a 70-percent submergence with 20 ft³/s, and determine the head loss. Using figure 8-19, find the intersection of the vertical 70-percent line with the slanting 20-ft³/s discharge line in the left side of the figure. Then, from this intersection, project a horizontal line to the intersection with the slanting line for the 4-ft throat width in the right side of the figure. From this point, project vertically down to read head loss on the bottom scale, which reads 0.43 ft.

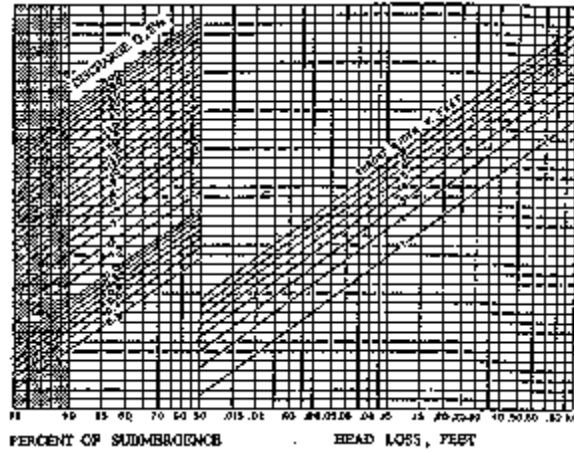


Figure 8-19 -- Head loss through 1- to 8-ft Parshall flumes (courtesy of U.S. Natural Resources Conservation Service.)

(3) Head Loss for 9-Inch Throats and Smaller

Losses for 9-in flumes and smaller are usually less critical, and the elevation of the upstream water surface is determined in the manner used for the

1-, 2-, and 3-in flumes. The difference between h_a and h_b is considered an adequate estimate of head loss.

Additional information for *Parshall Flumes*

The listings here should not be construed as an endorsement or recommendation of a service or product by the Bureau of Reclamation, Agricultural Research Service, Natural Resource Conservation Service, or other participants of these web pages. These are provided only as a convenience to our web clients. The listing below were selected based on a manufacture statement that they can provide a device related to this chapter or section.

Computing the Submerged-Flow Correction for Parshall Flumes

Tony L. Wahl

U. S. Bureau of Reclamation, Denver, Colorado, USA
twahl@do.usbr.gov

Preface: The information provided below is intended for use with *existing* Parshall flumes operating in the submerged-flow correction zone. *If you are contemplating construction of a new Parshall flume, you are strongly urged to consider a long-throated flume. Information about long-throated flumes is available at www.usbr.gov/wrrl/winflume*

Figures [8-16](#) and [8-17](#) in the [Water Measurement Manual](#), 3rd Edition (Chapter 8, Section 10), provide a means for correcting free-flow discharges through Parshall flumes to account for the effect of submergence. Figure [8-16](#) is for flumes of 1-ft width, and includes multiplying factors for use with flumes of 2- to 8-ft width. Figure [8-17](#) is for flumes of 10-ft width, again with multiplying factors for larger flumes up to 50-ft width, and can be easily converted to a single equation:

$$DQ = \frac{h_a^2 W}{10} [3.364 + 20.19S^2 \ln S]^2$$

where DQ is the discharge reduction in ft^3/s , h_a is the upstream head in feet, W is the flume width in feet, and S is the submergence ratio, h_b/h_a .

[Figure 8-16](#) is more difficult to convert to an equation form, due to its non-linear nature (in log-log space) at low upstream heads and low submergences. Hilaire Peck ("Submerged Flow in Parshall Flumes", in *Hydraulic Engineering*, Proceedings of the 1988 National Conference on Hydraulic Engineering, American Society of Civil Engineers, Colorado Springs, CO, August 8-12, 1988) tested 1-ft Parshall flumes and developed an equation to compute discharge reductions due to submergence:

$$DQ = 0.000132 h_a^{2.123} e^{9.284S}$$

where e is the base of natural logarithms, 2.7183. This equation yields smaller discharge reductions and does not have the non-linear character of Parshall's nomograph ([Fig. 8-16](#)).

Converting [Figure 8-16](#) to a tractable equation would be a tedious exercise. Also, Peck's more detailed experiments on 1-ft flumes indicate less discharge reduction due to submergence than do Parshall's limited data, making the value of such an effort questionable. More detailed physical testing is needed to extend Peck's data for use on 2- to 8-ft wide flumes.

However, in the interim, it is reasonable to use Peck's equation for 1-ft wide flumes and the multiplying factors shown on Figure 8-16 to obtain discharge corrections for 2- to 8-ft wide flumes, with one caveat. Peck's equation is only valid for flow conditions on the right side of the discontinuity that he observed in submerged flow rating curves (i.e., submergences less than about 85 to 90 percent). (Note: Peck has an equation applicable to the left side of the discontinuity, but procedures for defining the exact point of discontinuity are not well defined.)

Thus, for flumes of 1- to 8-ft width the discharge reduction in ft³/s can be computed using:

$$DQ = M(0.000132 h_a^{2.123} e^{9.284S})$$

where M is a multiplying factor that varies as follows:

Size of Flume, W (feet)	Multiplying Factor, M
1	1.0
1.5	1.4
2	1.8
3	2.4
4	3.1
5	3.7
6	4.3
7	4.9
8	5.4

11. Bibliography

Ackers, P., W.R. White, J.A. Perkins, and A.J.M. Harrison. *Weirs and Flumes for Flow Measurement*. John Wiley & Sons, New York, 327 pp, 1978.

American Society of Mechanical Engineers. *Fluid Meters, Their Theory and Application*. 6th edition revised. Report of American Society of Mechanical Engineers Research Committee on Fluid Meters, H.S. Bean, (ed.), American Society of Mechanical Engineers, New York, 202 pp., 1983.

Bos, M.G. (ed.). *Discharge Measurement Structures*. Third edition revised. Publication 20. International Institute for Land Reclamation and Improvement, PO Box 45, 6700 AA Wageningen, The Netherlands, 401 pp., 1989.

Bos, M.G., J.A. Replogle, and A.J. Clemmens. *Flow Measuring Flumes for Open Channel Systems*. American Society of Agricultural Engineers. Republication of book by same title, originally by John Wiley & Sons, New York, 1984, 321 pp., 1991.

Brakensiek, D.L., H.B. Osborn, and W.R. Rawls (coordinators/eds.). *Field Manual for Research in Agricultural Hydrology*. Agricultural Handbook 224, U.S. Department of Agriculture, U.S. Government Printing Office, Washington, DC, 547 pp., 1979.

Cheremisinoff, P.N., N.P. Cheremisinoff, and Su Ling Cheng (eds.). *Handbook of Civil Engineering Practice 2CHydraulics/ Mechanics*. Technomic Publishing Company, Inc., Lancaster, Pennsylvania, 780 pp., 1988.

Clemmens, A.J., and J.A. Replogle. *Constructing Simple Measuring Flumes for Irrigation Canals*. USDA Farmers Bulletin No. 2268, U.S. Department of Agriculture, 13 pp., 1980.

Clemmens, A.J., J.A. Replogle, and M.G. Bos. *FLUME: A Computer Model for Estimating Flow Through Long-Throated Measuring Flumes*. USDA Agricultural Research Service Publication, ARS-57, 68 pp., 1987.

Clemmens, A.J., M.G. Bos, and J.A. Replogle. *FLUME: Design and Calibration of Long-Throated Measuring Flumes*. Version 3.0. International Institute for Land Reclamation and Improvement, PO Box 45, 6700 AA Wageningen, The Netherlands, Publication 54 (with software), 1993.

Clemmens, A.J., T.L. Wahl, M.G. Bos, and J.A. Replogle, *Water Measurement with Flumes and Weirs*, ILRI Publication 58, International Institute for Land Reclamation and Improvement, PO Box 45, 6700 AA Wageningen, The Netherlands, 2001.

Dodge, R.A. "Ramp Flume Model Study-Progress Summary," GR-8-14, Bureau of Reclamation. Denver, Colorado, 1983.

Gwinn, W.R. "Calibration of Walnut Gulch Supercritical Flumes." *Journal of the Hydraulics Division*, American Society of Civil Engineers, 96(HY8)1681-1689, 1970.

Gwinn, W.R., and D.A. Parsons. "Discharge Equations for HS, H, and HL Flumes." In *Journal of the Hydraulics Division*, American Society of Civil Engineers. Volume 102:HY1, pp. 7388. Discussion: Volume 102:HY11, pp. 1704-1706. Closure: Volume 103:Hy7, p. 809, 1976.

Hoffman, G.J., T.A. Howell, and K.H. Solomon (eds.). *Management of Farm Irrigation Systems*. American Society of Agricultural Engineers, St Joseph, Michigan, 1,040 pp., 1991.

Kulin, G., and P.R. Compton. "A Guide to Methods and Standards for the Measurement of Water Flow." National Bureau of Standards, Special Publication 421, 1975.

Parshall, R.L. *Improving the Distribution of Water to Farmers by Use of the Parshall Measuring Flume*. Soil Conservation Service, Bulletin 488, U.S. Department of Agriculture and Colorado Agricultural Experiment Station, Colorado A&M College, Fort Collins, Colorado, 1945.

_____. *Parshall Flumes of Large Size*. Bulletin 426-A (reprint of Bulletin 386), Colorado Agricultural Experiment Station, Colorado State University, Fort Collins, Colorado, 1953.

Peck, H. "Submerged Flows in Parshall Flumes." *Proceedings, National Conference, Hydraulics Division of the American Society of Civil Engineers*, American Society of Civil Engineers, Colorado Springs, Colorado, 1988.

Replogle, J.A. "Critical Flow Flumes with Complex Cross Sections." In *Irrigation and Drainage in an Age of Competition for Resources*. Specialty Conference Proceedings, American Society of Civil Engineers, pp. 366-388, 1975.

Replogle, J.A., A.J. Clemmens, and M.G. Bos. "Measuring Irrigation Water," chapter 10, pp. 313-370. In *Management of Farm Irrigation Systems*. Hoffman, G., T.A. Howell, and K.H. Solomon (eds.), American Society of Agricultural Engineers, Monograph, St. Joseph, Michigan, 1991.

Robinson, A.R. *Parshall Measuring Flumes of Small Sizes*. Technical Bulletin No. 61, Agricultural Experiment Station, Colorado State University, Fort Collins, Colorado, 1957.

Robinson A.R., and A.R. Chamberlain. "Trapezoidal Flumes for Open Channel Flow Measurements." *Transactions, American Society of Agricultural Engineers*, vol. 3 (No. 2):120-124,128, 1960.

Skogerboe, G.V., R.S. Bennett, and W.R. Walker. "Generalized Discharge Relations for Cutthroat Flumes." *Journal of the Irrigation and Drainage Division*, American Society of Civil Engineers, vol. 98 No. IR4, pp. 569-583, 1972.

U.S. Department of Agriculture, Soil Conservation Service. "Measurement of Irrigation Water." *SCS National Engineering Handbook*, Section 15Irrigation, chapter 9, pp. 1-72, 1962.

Wahl, T.L., A.J. Clemmens, J.A. Replogle, and M.G. Bos, "WinFlume — Windows-Based Software for the Design of Long-Throated Measuring Flumes". Fourth Decennial National Irrigation Symposium, American Society of Agricultural Engineers, Nov. 14-16, 2000, Phoenix, AZ. http://www.usbr.gov/pmts/hydraulics_lab/winflume/

Wells, E.A., and H.B. Gotaas. "Design of Venturi Flumes in Circular Conduits." *Transactions of the American Society of Civil Engineers*, vol. 123, pp. 749-771, 1958.

CHAPTER 9 - SUBMERGED ORIFICES

1. Definition and Classification of Orifices

An orifice used as a measuring device is a well-defined, sharp-edged opening in a wall or bulkhead through which flow occurs. Orifices may be used to measure rates of flow when the size and shape of the orifices and the heads acting upon them are known. For irrigation use, orifices are commonly circular or rectangular in shape and are generally placed in vertical surfaces, perpendicular to the direction of channel flow.

A submerged orifice and the same orifice discharging freely have nearly the same coefficient of discharge. Submerging an orifice provides the capability to measure relatively large flows with a small drop in water surface, conserving delivery head compared with weirs. However, the submerged orifice requires head measurements upstream and downstream. The difference between the two heads is used in the orifice equation (equation 9-1). A free-flow measurement requires measurement of only one upstream head.

Using an orifice as a water measuring device demands attention to dimensions and craftsmanship, and the orifice must closely simulate conditions existing when it was calibrated. Equation coefficients depend on these details and can vary considerably. For full contraction, the orifice plate should be machined around the entire perimeter of the opening to a clean, straight, and sharp upstream edge and corner in the direction of the flow. Rounding of an upstream face corner can partially or fully suppress contraction. For example, 1-percent rounding of the upstream face corner of the opening perimeter in terms of minimum orifice opening dimension causes about a 3-percent increase of the contraction coefficient. A well-designed bellmouth will eliminate all contraction (Schuster, 1970).

Orifices may be partially contracted in two senses. One is the amount of curvature of the jet in the direction of flow and the other in the amount of orifice opening perimeter which produces no curvature of the jet passing through the opening. The latter is called suppression. An example of a partially suppressed orifice is a sluice gate, where the approach boundary on the sides and bottom continues past the sharp edge of the gate leaf above. This arrangement eliminates the jet contraction along part of the orifice opening perimeter, increasing the effective coefficient of discharge.

Coefficients are used in equations to account for: neglecting the approach velocity head, the approach velocity distribution, the decrease of jet velocity caused by friction, and the amount of jet contraction caused by the flow curving around the corner of the orifice perimeter.

The proximity of the upstream water surface to the top of the orifice opening affects the amount of contraction. For full contraction, the water surface upstream from the orifice must always be well above the top of the opening. Similar to weirs, if the bottom or the side walls of the approach channel are too close to the orifice edges, then the sides and bottom of the orifice jet are not fully contracted. If the upstream water surface drops below the top of the opening, the opening, in effect, becomes a weir.

2. Advantages and Disadvantages

Submerged orifices conserve head and are used where fall is insufficient for weirs. Submerged orifices can be used where cost, space limitations, or other site conditions do not justify a weir or flume. A disadvantage of the submerged orifice is that accumulations of submerged debris or sand and sediment upstream from the orifice may prevent accurate measurements. Severe blockage with trash could cause upstream bank overtopping. Where fall is not limited and space is available, a long-throated flume should ordinarily be chosen. Both weirs and flumes are less susceptible to interference from weeds and trash, and clogging is easily visible. Typically, sharp-crested weirs and some long-throated flumes are less expensive and more accurate.

3. Fully Contracted Submerged Orifice

The principal type of submerged orifice used for measuring irrigation water in an open channel is the vertical, sharp-edged, fully contracted, rectangular orifice. This orifice is accurate and is the principal type for which the discharge coefficient has been carefully determined. The longer dimension of the rectangle is horizontal to help meet the approach flow boundary conditions discussed in the next section of this chapter. Such an orifice is illustrated on figure 9-1 with recommended box dimensions on figure 9-1 given in table 9-1.

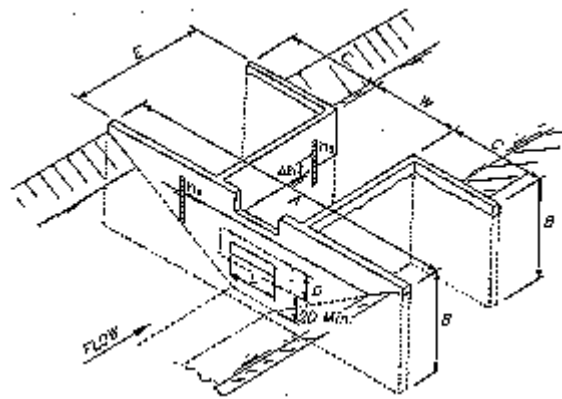


Figure 9-1 -- Submerged-orifice measurement structure viewed from upstream (refer to table 9-1 for dimensions).

Table 9-1. Recommended box sizes and dimensions for a submerged orifice						
Size of orifice		Height of structure, B (ft)	Width of head wall, A (ft)	Length, E (ft)	Width, W (ft)	Length of downstream wing wall, C (ft)
<i>Height, D (in)</i>	<i>Length, L (in)</i>					
3	12	4	10	3.0	2.5	2
3	24	4	12	3.0	3.5	2
6	12	5	12	3.5	2.5	3
6	18	5	14	3.5	3.0	3
6	24	5	14	3.5	3.5	3
9	16	6	14	3.5	3.0	3
9	24	6	16	3.5	3.5	3

4. Conditions for Accuracy of Fully Contracted Submerged Rectangular Orifices

The standard submerged rectangular orifice described on [figure 9-1](#) and in [table 9-1](#) has four sides, consisting of thin-edged plates, far enough removed from the sides, bottom, and top of the water prism in the approach channel that essentially full jet contraction occurs. The contraction which occurs is about equal to the maximum that could be obtained with the sides of the orifice at infinite distances from the water prism boundaries.

The following conditions are required to accurately replicate equation 9-1 coefficients and use [table 9-1](#):

- (1) The upstream edges of the orifice should be straight, sharp, and smooth.
- (2) The upstream face of the orifice wall should be vertical.
- (3) The top and bottom edges of the orifice opening should be level.
- (4) The sides of the opening should be truly vertical.
- (5) The inset orifice plates must be flush, and the upstream face of the supporting bulkhead with the fasteners must be countersunk on the upstream side.
- (6) The distance from the opening edges to the boundary and the water surface, both on the upstream and downstream sides, should be greater than twice the least dimension of the orifice opening.
- (7) The face of the plates must be free of grease and oil.
- (8) Avoid orifice plate knife edges because they are a safety hazard and can damage easily; orifice opening plate perimeter should be between 0.03 and 0.08 inch (in) thick.
- (9) If the plates are thicker than condition (8), the plate edges should be reduced to the required thickness by chamfering the downstream edge of the orifice plates to an angle of at least 45 degrees.
- (10) Flow edges of plates require machining or filing perpendicular to the upstream face to remove burrs or scratches and should not be smoothed off with abrasive cloth or paper.
- (11) The edges of the supporting bulkhead wall cutout to receive the orifice opening plate should be located at least one wall thickness from the orifice opening edges.
- (12) For submerged flow, the effective head on the orifice is the actual difference in elevation between the water surfaces upstream and downstream from the orifice wall. The differential head should be at least 0.2 foot (ft).
- (13) For free flow, the effective head on the orifice is the difference in elevation between the upstream water surface and the center of the orifice opening.

(14) The cross-sectional area of the water prism 20 to 30 ft upstream from the orifice should be at least eight times the cross-sectional area of the orifice.

(15) The selected type of head measuring device must be compatible with required project accuracy and the amount of head loss that is acceptable.

If all these requirements are satisfied, then the effective discharge coefficient is good to +/-2 percent. However, the accuracy of discharge measurement depends strongly on the secondary head measurement system selected and the magnitude of Δh . Chapter 8 contains error values for different head measurement systems.

5. Discharge Through a Submerged Rectangular Orifice

The equation for computing the discharge of the standard submerged rectangular orifice is:

$$Q = C_c C_{vf} C_{va} A \sqrt{2g(h_1 - h_2)} \quad (9-1b)$$

where:

Q = discharge (ft³/s)

C_c = coefficient of contraction

C_{vf} = coefficient of velocity caused by friction loss

C_{va} = coefficient to account for exclusion of approach velocity head from the equation

A = the area of the orifice (ft²)

g = acceleration caused by gravity (ft/s²)

h_1 = upstream head (ft)

h_2 = downstream head (ft)

The coefficient of contraction, C_c , accounts for the flow area reduction of the jet caused by the flow curving and springing from the orifice edges. The coefficient C_{vf} accounts for the velocity distribution and friction loss. The product, $C_c C_{vf}$, is sometimes called the coefficient of discharge, C_d . The coefficient C_{va} accounts for using the water head only and does not fully account for the velocity head of approach. This coefficient is near unity if all the requirements of section 4 are met. The effective discharge coefficient, C_d , is the product $C_c C_{vf} C_{va}$, which has been determined experimentally to be 0.61 for rectangular irrigation weirs. The coefficient of contraction has the most influence on the effective coefficient discharge. Because C_c must approach unity as velocity approaches zero, its value will increase rapidly after reaching some low velocity. Thus, the equation should not be used for heads less than 0.2 ft even with very precise head measuring devices. The difference between upstream and downstream heads or water surface elevations is sometimes called the differential head, and equation 9-1a can be rewritten as:

$$Q = C_d A \sqrt{2g\Delta h} \quad (9-1b)$$

where:

$$\Delta h = h_1 - h_2, \text{ differential head}$$
$$C_d = 0.61, \text{ as determined experimentally.}$$

The discharge, when velocity of approach is negligible, may be computed using equation 9-1b. [Table A9-2](#)¹ was prepared for orifice areas from 0.25 to 2.0 ft².

¹ The prefix "A" denotes tables that are located in the appendix.

6. Dimensions for Fully Contracted Submerged Rectangular Orifices

The most suitable proportions for standard submerged rectangular orifices are those in which the height, D , is considerably less than the width, L . Usually, these proportions are preferred because of shallow flow depths in some canals and open laterals. [Figure 9-1](#) and [table 9-1](#) provide recommended dimensions for wood or concrete submerged-orifice structures.

The size of the orifice selected for a particular situation is governed by the quantity of water to be measured and the head available. The precision of the head measuring system relative to the minimum required differential needs to be considered when selecting size. For example, if staff gages are used which can only read head to within ± 0.005 ft, the uncertainty of the differential is ± 0.01 ft. This uncertainty in the head causes a discharge error of ± 2.5 percent at a differential head of 0.2 ft. Chapter 3 gives more detailed examples of error calculations at low heads for selection of head measuring devices. Chapter 8 contains head error information for different measurement systems

7. Construction and Setting of Standard Fully Contracted Submerged Orifices

Submerged-orifice structures should be substantially constructed of concrete or, under certain circumstances, of wood. The structure should extend several conduit widths downstream from the orifice wall to provide erosion protection in unlined channels. The floor and sides of the box conduit downstream from the orifice opening should be set outward from the opening a distance of at least twice the smallest orifice opening dimension. A flashboard may be placed at the downstream end of the orifice box conduit to assure submergence of the orifice; however, the flashboard should be sufficiently downstream to prevent disturbing the water issuing from the orifice. The orifice wall should be set truly vertical, and the top of the wall should reach only to the maximum expected water level, so the wall can act as an overflow weir in the event of operational difficulties. Wingwalls or cutoff walls should be provided at the upstream and downstream end of the orifice box conduit to prevent undermining the orifice structure and leakage around the structure. [Figure 9-1](#) and [table 91](#) provide recommended dimensions for a concrete or wood submerged-orifice structure.

8. Discharge Adjustment for Contraction Suppression in Submerged Orifices

Because effective discharge coefficients are not well defined where suppression exists, use of a standard fully contracted orifice is desirable wherever conditions permit. However, a bottom suppressed orifice allows the sediment to pass the structure.

To avoid accumulations of sediment on the upstream side of the orifice, the bottom contraction may need to be suppressed by placing the lower side of the orifice at canal grade. In occasional instances, use of orifices with both bottom and side contractions suppressed may be necessary.

For rectangular submerged orifices having partially suppressed perimeter contraction and negligible velocity of approach assured by providing an approach area at least 8 times larger than the orifice opening, the approximate discharge may be computed by:

$$Q_s = 0.61(1 + 0.15r) A \sqrt{2g\Delta h}$$

where:

Q_s = discharge of the suppressed orifice in ft³/s, velocity of approach neglected
 r = ratio of the suppressed portion of the perimeter of the orifice to the total perimeter

The variables Δh , A , and g have the same significance as in equation 9-1b. The term in the parentheses can be thought of as a factor that adjusts the fully contracted effective coefficient of discharge used in equation 9-1b in terms of amount of perimeter with suppressed contraction. This method is expected to produce a coefficient correct to within about +/-3.0 percent.

As a temporary estimating procedure, this method can be used to estimate discharge when sediment deposits are present in the approach to an orifice that was meant to be fully contracted. If the deposits were similar in effect to a smooth invert at the bottom of the orifice, the correction would be good. However, the accuracy of the estimated correction is usually in doubt because of the shape, depth, and location of the deposits. Best practice would require removing the sediment immediately rather than making the discharge adjustment.

Equation 9-2 can be used for sluice gates when they are in effect bottom and/or side suppressed rectangular orifices with variable opening area. [Table A9-3](#) gives discharge versus head for orifices that are both bottom and side suppressed for orifice areas of 2 ft² to 125 ft². Other more exact and complex approaches can be used for determining discharge with sluice gates. These approaches are discussed by Bos (1989), who states that equation 9-2 agrees closely to relationships developed by Henry (1950) and Franke (1968).

9. Requirements for Suppressed Submerged Rectangular Orifices

The requirements in section 4 related to distance from the sides and bottom do not apply. However, all the remaining requirements apply. Element (14) concerning approach area is especially important.

10. Excess Velocity of Approach

Submerged orifices should be installed, operated, and maintained in such a way as to make the velocity of approach negligible. To prevent excess velocity of approach, the size of the approach flow area should be greater than eight times the size of the orifice opening. Generally, the requirements of section 4 of this chapter will prevent excess velocity of approach. The original tables presented by Christiansen (1935) limit velocity of approach to about 0.5 foot per second (ft/s).

To account for excess velocity of approach, the approach velocity head is frequently added to the differential head under the radical assuming that the effective coefficient of discharge does not change. However, in equation 9-1b, this correction assumes that all the correction is accounted for by an approach velocity head term alone. However, this procedure only constitutes a partial correction. The factors that cause excess velocity of approach also cause changes in the contraction and head loss. Thus, the effective discharge coefficient changes by some undefined amount. It is better to find the cause of excess velocity, and if operation changes or maintenance cannot remedy the problem, then a replacement device may be required.

Orifices can be calibrated for velocity of approach effects by comparing against another device. This comparison would require measurements at given discharges at several upstream and downstream heads. The cost of these measurements most likely would exceed the cost of a replacement measuring device.

11. Constant-Head Orifice (CHO) Turnout

(a) General Description

A water measuring device frequently used in irrigation is a combination regulating gate and measuring gate structure. This device uses an adjustable rectangular gate opening as a submerged orifice for discharge measurement and a less expensive circular gate downstream. This system is called the CHO turnout. For convenience, it is operated by setting and maintaining a constant head differential across the orifice. Discharges are set and varied by changing the gate opening. These structures may be used in place of meter gates or turnout gate-and-weir combinations to regulate and measure flows from canals and open laterals into smaller ditches. The turnouts are usually placed at right angles to the main canal or open lateral. Typical CHO turnouts are shown on figures 9-2 and 9-3.

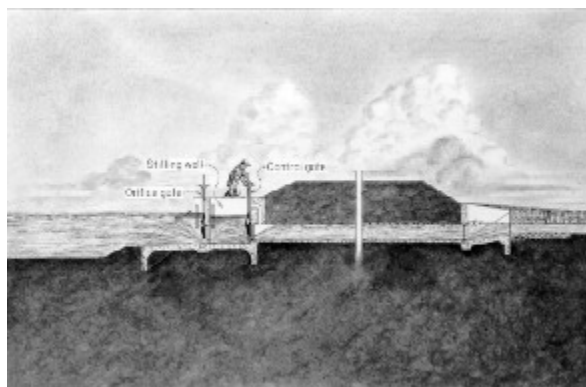


Figure 9-2 -- Schematic diagram of a CHO turnout.



Figure 9-3 -- A single-barrel CHO turnout.

The CHO turnout consists of a short entrance channel leading to a headwall containing one or more gate-controlled openings, a head measurement stilling basin section, and a downstream headwall with one or more gate-controlled barrels that release the flow into the delivery channel (figure 9-4). The rate of flow is measured by using the principle that a submerged orifice of a given size operating under a specific differential head will always pass the same known quantity of water. The upstream gate or gates serve as orifices. The orifice area can be increased or decreased by adjusting the upstream gate or gates. Usually, the head differential is maintained at a constant value, usually 0.20 ft (Δh on figure 9-4) measured by staff gages or stilling wells located upstream and downstream from the orifice gate headwall.

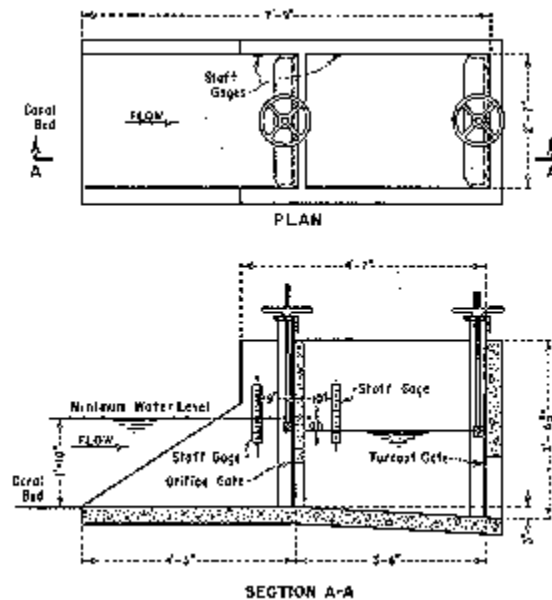


Figure 9-4 -- Schematic view of a single-barrel CHO turnout with a horizontal inlet channel.

To set a given flow, the opening of the orifice for the desired discharge is obtained from discharge tables ([tables A9-4 and A9-5](#) for the older 20- and 10-ft³/s sizes). With the upstream gates set at this opening, the downstream gates are adjusted until the differential head across the orifice as measured by the staff gages or stilling wells is at the required constant head (usually 0.20 ft). The discharge will then be at the desired value.

Two sizes of orifice gates, 24 by 18 in and 30 by 24 in, have been used extensively in the past. Both sizes are provided in single-barrel and double-barrel designs. The capacity of the single-barrel 24- by 18-in turnout is 5.0 ft³/s. The capacity of the single-barrel 30 by 24-in turnout is 10 ft³/s. Double-barrel installations have twice the capacity of the single-barrel ones. Newer designs (Aisenbrey et al., 1978) provide standard CHO turnouts for discharges of 2-, 4-, 6-, 9-, 12-, 15-, 18-, 24-, and 30-ft³/s with corresponding opening widths of 1.5, 1.5, 2.0, 2.5, 2.5, 3.0, 3.5, 4.0, 4.0 ft. The gate sizes for these turnouts vary from 18 to 48 in.

[Table A9-6](#) gives discharge versus gate opening for these turnout sizes with a differential head of 0.2 ft.

(b) Discharge Calibrations

Calibration tests for the original design sizes were conducted in the Bureau of Reclamation (Reclamation) laboratories in Denver, Colorado, on one-half-scale models of 24- by 18-in CHO turnouts (Blackwell, 1946). The effective coefficient of discharge varied from 0.68 to 0.72 as gate opening increased from 0.2 to 1.5 ft. These tests covered ratios of approach head to gate opening of from 6 to 2, respectively. To produce [tables A9-4](#) and A9-5, the effective coefficient of 0.70 at the ratio of 4 was used in tables for both single-barrel and double-barrel structures with a standard set head differential of 0.2 ft. Thus, the table values are good to +/-3.0 percent.

Discharge tables for the newer CHO sizes (Aisenbrey et al., 1978) are also based upon a coefficient of 0.70. Discharge for standard head differential of 0.2 ft is provided on standard drawings and in [table A9-6](#). For the 2-ft³/s CHO turnout, with minimum canal water surface elevation and maximum recommended orifice gate opening, the submergence ratio (approach depth to opening) is about 4. As the turnout size increases, the minimum approach submergence ratio decreases to become about 2 for 15-ft³/s and larger sizes.

Differential heads other than 0.2 ft can be used, but equation 9-1b and an effective coefficient of 0.70 must be used to compute discharges or to generate new tables.

To provide CHO calibrations and structural designs for sizes not actually calibrated using a discharge coefficient of 0.70 and to attain "3 percent equation accuracy, Aisenbrey et al. (1978) give the following design criteria for smaller and larger CHO turnouts with capacities up to 30 ft³/s:

- For maximum capacities of 10 ft³/s and less, the length of gate basin should be at least 2.25 times the maximum gate opening or 1.75 times the gate support wall opening, whichever is greater. However, no basin length should be less than 3.5 ft.
- For capacities between 10 ft³/s and 30 ft³/s, the gate basin length should be at least 2.75 times the maximum gate opening. The bottom of the gate basin should be level.
- The gate opening should be less than or equal to 0.8 times the wall gate support wall opening.

- The distance from the gate lip to the top of the gate support wall opening should be at least equal to the wall thickness.
- The approach flow submergence above the top of the opening should be 1.78 times the velocity head plus 0.25 ft.
- The set head differential should be at least 0.2 ft.

An important detail of the Reclamation orifice gate design is a 1-1/2- by 1-1/2-in angle iron brace projecting upstream on the face. The projecting leg of angle iron is located 1-3/4 in from the gate lip. Some of the smaller gates were built without this brace and were field calibrated with weirs. They were found to have an effective coefficient of 0.65. When this bracing is missing, equation 9-1b and this lower coefficient must be used to calculate discharges or tables.

Colorado State University (CSU) tests (Kruse, 1965) determined that the effective discharge coefficient is about 0.65 for the normal operation where the depth upstream from the turnout is 2.5 or more times the maximum gate opening. This coefficient is the same value that Reclamation determined for no angle iron bracing at the bottom of the upstream gate face.

CSU also investigated the effects of changes in upstream and downstream water levels, sediment deposits, plugging of the orifice gate with weeds and debris, and approach flow conditions.

For discharges larger than about 30 ft³/s, special structures involving multiple gates and barrels are designed for the particular site and flow requirements.

(c) Effects of Upstream Water Depth

When the depth of water upstream from the orifice gate is four or more times the height of the opening of the orifice, the coefficient of discharge, C , remains essentially constant at 0.65 (Kruse, 1965). When the depth of water upstream is less than four times the orifice opening, the coefficient increases. The rate of increase is moderate at submergence ratios between 4 and 2.5, but rapid at submergence ratios below 2.5.

Attempting to predict the coefficients for different installations having low submergence ratios is impractical and inaccurate, and doing so is not recommended. Structures should be installed so the minimum water depth in front of the orifice gate will be at least 2.5 times, but preferably 4 or more times, the maximum expected gate opening. In some cases, to place the structure low enough, the inlet channel may need to be sloped downward as shown on figure 9-5. An alternative design in which the inlet floor is abruptly stepped downward is also used.

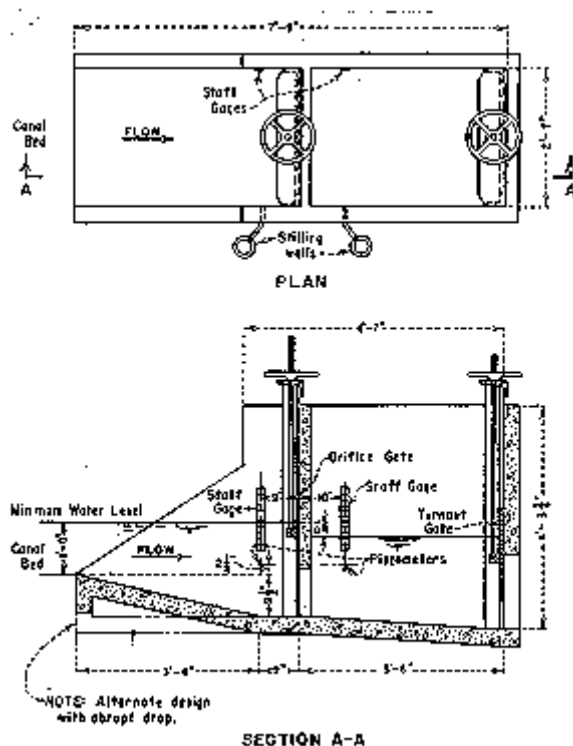


Figure 9-5 -- Schematic view of a CHO turnout with a sloping inlet channel and with piezometers and stilling wells.

(d) Effects of Upstream and Downstream Water Depth

Because of its name, the CHO is often mistakenly thought to maintain the constant head differential after setting when the water surface changes in the supply canal. However, the CHO cannot maintain this constant differential because the orifice gate coefficient varies with upstream submergence and differs from the downstream control gate coefficient.

A change in tailwater depth or downstream submergence on the control gate after a discharge has been set also can cause a significant change in the flow rate. The set differential changes because the two gates have different coefficient characteristics relative to their shape and response to amount of submergence. If considerable drop exists in the channel downstream from the turnout, tailwater will have no effect on flow measurement. However, if the CHO turnout is placed at about the same grade as the ditch it is supplying, the discharge may be affected as the water level changes.

Therefore, whenever tailwater or downstream delivery depth can affect the rate of flow, the ditchrider must make the necessary and frequent adjustments until flow conditions in the ditch become stable.

(e) Effects of Sediment and Weeds

In common irrigation use, sediment is usually swept through the orifice and the downstream gates during normal operation (Blackwell, 1946). The small sediment accumulations that occur in the stilling basin between the gates have little or no effect upon performance. Thus, sediment is usually not a problem in CHO turnouts.

Choking caused by weeds that become lodged within the measuring orifice can be serious. Moreover, choking can be difficult to detect when silty water is flowing because the orifice cannot be seen. The principal cause of choking is the presence of waterlogged weeds that catch in the gate opening. These weeds may trap other particles and eventually plug the turnout. The measuring accuracy of CHO turnouts is greatly reduced by the presence of even a few weeds. Care must be taken to ensure that the orifice and the area upstream from the orifice are kept completely clear of weeds and other debris. Trashescreens or trashracks are sometimes placed at the inlet to the CHO turnout.

(f) Effects of Approach Flow Condition

The turnouts are usually placed at 90 degrees to the canal centerline (figure 9-3). As a result, when the flow in the canal moves past the turnout, an eddy and related flow disturbances occur at the turnout entrance. This eddy and the other flow disturbances affect the flow into the turnout. The intensity of the disturbances depends largely upon the velocity of the passing supply canal flow. For small gate openings, the discharge coefficient, C , for the turnout increases from a value of 0.64 for a canal flow velocity of 1 ft/s to a value of 0.69 for a canal flow velocity of about 3 ft/s (Blackwell, 1946). On the other hand, with large gate openings, increasing the canal flow velocity near the turnout decreases the coefficient from high values of about 0.74 for canal flow velocities of 1.0 ft/s to low values of about 0.63 for canal flow velocities of 3.0 ft/s. This appreciable, but inconsistent, effect upon the measuring accuracy of CHO turnouts must be recognized. This error is greatest at the larger orifice openings. Whenever possible, installations should be designed so that relatively low flow velocities prevail at the turnout, especially if larger openings are to be used. Fortunately, the normal flow velocity distribution in canals provides relatively low velocities near the banks.

(g) Head Measurements

In the standard CHO turnout, the head differential across the orifice, or upstream gate, is determined by reading staff gages just upstream and downstream from the headwall on which the upstream gate is mounted (figure 9-4). Rough water surfaces at these gages can easily result in large head reading errors. These errors are particularly bad during large flows when the water surface in the stilling basin downstream from the orifice opening may be quite unsteady or tilted. Head reading errors can cause significant errors in flow measuring accuracy, and every reasonable effort should be made to avoid them. Chapters 6 and 8 show other ways of stilling the water surface to make head measurement more accurate.

Stilling devices to reduce water surface fluctuations at the staff gages can reduce head measurement errors. External stilling wells connected to piezometers upstream and downstream from the orifice gate greatly increase the potential accuracy of head readings and of the discharge measurements (figure 9-5). Additional information regarding stilling wells can be found in chapters 6 and 8. For existing structures, small wooden or metal shelf-type stilling devices installed within the flow area across the inlet and across the stilling basin near the staff gages will help reduce reading errors caused by vortices and waves (figure 9-6).

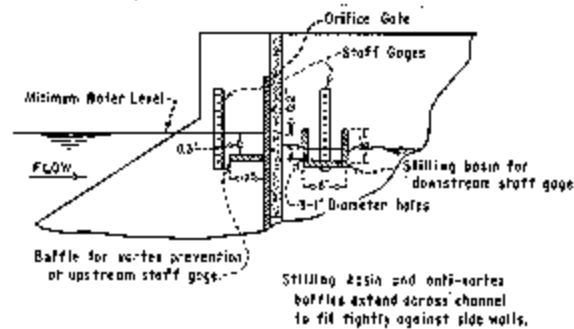


Figure 9-6 -- Baffles to reduce water surface fluctuations at staff gages in CHO turnouts.

12. Orifice Check Structures

Occasionally, at a given site, the canal water surface level should be checked up to a specified elevation while simultaneously measuring the rate of flow. The combined checking and measuring functions can be provided by orifice check structures which are built into the canals as in-line structures (figure 9-7). One or more orifice openings of the necessary size are constructed in the lower portion of a wall that extends across the canal at the upstream end of the check-type structure. These orifices are used to measure the discharge. A second wall with one or more gated openings is constructed at the downstream end of the structure. This downstream control is used to check the canal water surface to the desired elevation. Two stilling wells are located outside of the structure. One is connected to a piezometer in the canal upstream from the orifice wall, and the other is connected to a piezometer in the basin between the upstream and downstream walls. In small orifice check structures, staff gages are used in place of piezometer and stilling wells. In either case, the differential head acting across the orifice can be determined, and with knowledge of the orifice dimensions and characteristics, the rate of flow can be determined.



Figure 9-7 -- Gated orifice check structure used to maintain upstream water surface levels and to measure rates of flow in the Courtland Canal, Nebraska.

The coefficients of discharge that should be used to compute the rate of flow are difficult to determine analytically because of different degrees of suppression at the bottom and sides and between the orifice openings.

Computed discharge tables are ordinarily provided for each structure, but usually a statement is included that a field rating is necessary to ensure accurate results. In general, the recommended practice is that field ratings be made by current meter data and that discharge curves be prepared. For maximum potential accuracy, care must be exercised to prevent either excessively small gate openings or small differential head readings that cause large errors of precision of head or gate opening effects on discharge measurement.

13. Radial Gate Checks Used for Measuring Device

Radial gates are widely used in canal check structures to control canal flows and water levels. By measuring upstream water level, downstream water level, and gate position, radial gate checks can also be used to compute flow. Computing flow at check structures prevents the additional cost and head loss from flow measurement devices such as flumes, weirs, or flow meters.

Radial gate flow is a type of variable-area orifice flow, which may be either free or submerged. However, accurate computation of radial gate flow requires complex analysis. Discharge under a radial gate is influenced by numerous parameters and structure dimensions. Figure 9-8 shows a typical radial gate with some of the variables that affect gate flow. The angle θ of the gate's bottom edge (gate lip) varies with the gate opening, G_o , the pinion height, PH , and the gate's radius, r . Flow contraction is sensitive to the angle θ , the type of gate lip seal, and water levels.

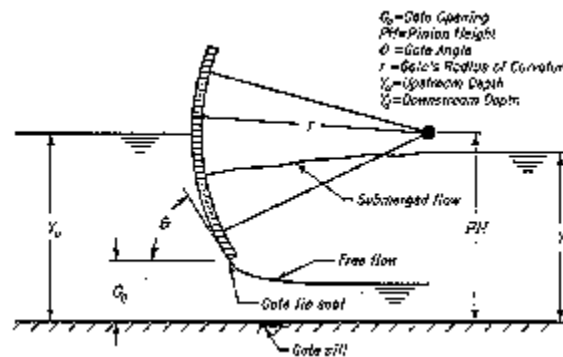


Figure 9-8 -- Diagram of radial gate showing calibration variables.

The general equation for flow through an undershot gate can be derived from the Bernoulli equation and expressed as:

$$Q = C_d G_o B \sqrt{2gH} \quad (9-3)$$

where:

Q = discharge (gate flow)
 C_d = coefficient of discharge
 G_o = vertical gate opening
 B = gate width

g = gravitational constant
 H = a head term

The head term, H , in the above equation can be either the upstream depth, Y_u , or the differential head across the gate, $Y_u - Y_d$ (see figure 98). When differential head is used, equation 9-3 becomes the well-known "orifice" equation. The development of the coefficient of discharge, C_d , depends on the definition of the head term as well as the various other parameters that affect gate flow. C_d has been predicted using a number of different methods, but most of these methods have limited application and accuracy.

In 1983, a research program at Reclamation's Hydraulics Laboratory developed gate flow algorithms that represent the complete discharge characteristics for canal radial gate check structures.

These algorithms are a complex set of equations that cover the range of water levels and gate geometry normally encountered at canal check structures. When applied correctly, they can be as accurate as any canal flow measurement device or procedure. The main disadvantages to using these algorithms are their complexity and the requirement to accurately measure two water levels, Y_u and Y_d , and the gate position, G_o . Additionally, sedimentation or check structure subsidence can change gate flow characteristics at existing structures and require recalibration over time.

A computer program has been developed to solve the radial gate flow algorithms. Program RADGAT executes on a personal computer to calculate either flow or gate position at a canal radial gate check structure. The user enters structure dimensions such as gate width, pinion height, gate radius, pier width (between gates), invert elevations, canal bottom widths and side slopes, and head loss coefficients for open transitions and siphons. These physical properties are saved in a data file so they need not be reentered for successive program execution. Then, the user enters upstream and downstream water depths and has the option either to compute discharge for a given gate opening or compute gate opening for a given discharge. RADGAT can also produce rating tables of flow versus gate opening for a range of upstream and downstream depths.

Buyalski (1983) contains detailed results from the research program and explanation of the discharge algorithms. It also contains the original version of program RADGAT developed for main-frame computer application. The personal computer version of RADGAT may be obtained through Reclamation's Water Resources Research Laboratory in Denver, Colorado.

14. Meter Gates

In the past, meter gates have been used for controlling and measuring irrigation flows (figure 9-9) (Schuster, 1970; Ball, 1961). These gates are basically modified, submerged, variable area orifices (slide gates) at the upstream end of a length of smooth or corrugated pipe. The gate leaf has either a round or square bottom over the entrance. Wells provide a means of measuring the head upstream and downstream from the gate, designated h_1 and h_2 , respectively. The upstream head, h_1 , is measured in the well connected to the headwall located a certain distance to the side of the gate opening. The downstream head, h_2 , is measured in the other well, which is connected to the pipe a short distance downstream from the gate. The difference in head in the two wells is the effective operating head across the gate. The discharge is then determined by the proper equation or a table provided by the manufacturers.

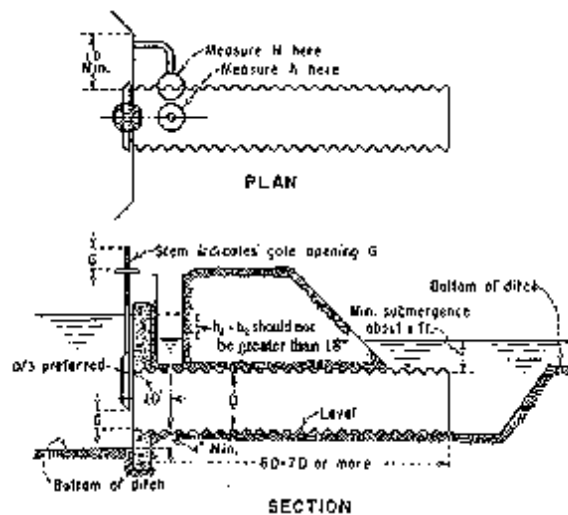


Figure 9-9 -- Typical meter gate installation.

Meter gates are usually purchased from commercial suppliers who furnish discharge tables for their product. Generally, the tables are reasonably accurate. In some instances, errors of 18 percent or more have been found. A number of characteristics of meter gates influence their performance, particularly when they are operated at openings larger than 50 percent or the upstream submergence above the crown of the pipe is less than the inside pipe diameter.

The discharge table being used should be checked to ensure that it applies to the brand and type of gate being used. Tables for round-bottom gates must not be used for square-bottom gates and vice versa. Gate settings must be made and read accurately, which requires that the gate position indicators be in good condition and show the true openings. The stilling wells should be periodically flushed to make sure they are operating properly and are free of obstructions and silt. Staff gages or scales should also be checked to be sure they have been secured in the proper zero position.

Weeds, trash, and sediment must be removed from the approach to the gates because they can cause flow disturbances that result in erroneous head differential readings. This requirement is particularly important along the wing walls because these walls have more effect upon the flow than does the alignment of the bottom. The approach effects are particularly important at gate openings greater than 50 percent.

Low head wall submergence over the meter gate entrance can also result in discharge errors, particularly at gate openings greater than 75 percent. Considerable error results when the head is less than one pipe diameter above the top of the pipe. Sufficient submergence must also occur at the downstream end of the conduit to ensure that the conduit flows full and that a readable water surface is present in the downstream stilling well, which will usually require at least 1 ft of water depth above the pipe crown. This amount of submergence will normally prevent scour damage downstream in earthen ditches.

Large errors in discharge determination can be introduced if the differential head (difference in water surface elevation between the two stilling wells) is small. For example, in reading the two water surface elevations in the stilling wells, an error of 0.01 ft could be made in each reading, giving a possible value of 0.10 ft for a true differential head of 0.08 ft. For a true discharge of 1.10 ft³/s through an 18-in meter gate open 5 in, the difference in the indicated discharge would be about 0.12 ft³/s, an error of about 11 percent. If the gate opening was reduced to 2 in, and the upstream pool could be allowed to rise to pass the same discharge, the differential head would be 0.40 ft, and the same head-reading error of 0.02 ft would indicate a change of only 0.03 ft³/s. The error in discharge determination would be reduced from about 11 percent to less than 3 percent.

The head in the downstream measuring well can vary widely depending upon the longitudinal and lateral location of the pressure tap in the pipe. Placing the pressure tap of the downstream measuring well 12 in from the gate is a special case requiring special calibration for each size gate unless the maximum gate opening is limited. A better location for the downstream piezometer would be at a distance $D/3$, measured from the downstream face of the gate. The pressure gradeline here is lower and flatter. Minor variations in piezometer locations would not result in major measuring errors, and the measured head differential would be greater. However, if the piezometer is moved to this point, the meter must be recalibrated because the manufacturer's published tables will not apply.

Laboratory tests have been conducted on square-bottom, flat-leaf meter gates to determine the coefficient of discharge, C_d , for a pressure tap located at a distance $D/3$ downstream from the gate (Ball, 1961). This curve, shown on figure 9-10, is valid for all sizes of square-bottom, flat-leaf meter gates under the following standard conditions:

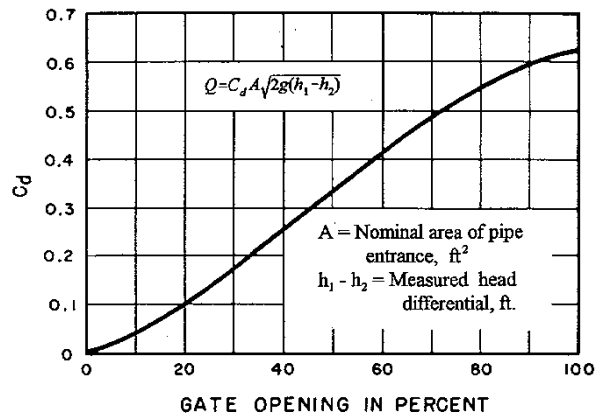


Figure 9-10 -- Coefficient of discharge curve for meter gates with downstream pressure tap at $D/3$.

- (1) An approach channel floor sloping upward, 2 to 1, toward the gate, with the downstream end of the floor a distance $0.17D$ below the pipe entrance invert.
- (2) Flaring entrance walls, 8 to 1, starting a distance $D/4$ from the edges of the gate frame.
- (3) Zero gate openings set when the bottom of the leaf is at the invert of the entrance.
- (4) Upstream submergence greater than D .
- (5) The downstream end of the pipe submerged to make the pipe flow full.

It should be noted that the coefficient C_d is used with A , which is the area of the pipe and not the gate opening. Discharges may be computed from this equation with an accuracy of ± 2.5 percent. The degree of downstream submergence does not affect the accuracy of the meter if water rises sufficiently in the downstream well to obtain an accurate reading and the pipe runs full at the outlet.

15. Bibliography

Aisenbrey A.J., Jr, R.B. Hayes, H.J. Warren, D.L. Winsett, and R.B. Young, *Design of Small Canal Structures*, Bureau of Reclamation, Denver, CO, 1978.

Ball, J.W., "Flow Characteristics and Limitation of Screw-Lift Vertical Metergates," Hydraulic Laboratory Report No. HYD-471, Bureau of Reclamation, Denver, CO, March 15, 1961.

Blackwell, B.T., "Calibration of the Constant-Head Orifice Turnout 1:2 Scale Model," Hydraulic Laboratory Report No. HYD-216, Bureau of Reclamation, Denver, CO, November 25, 1946 (unpublished).

Bos, M.G., ed., *Discharge Measurement Structures*, International Institute for Land Reclamation and Improvement, Publication 20, third revised edition, Wageningen, The Netherlands, 1989.

Buyalski, C.P., "Discharge Algorithms for Canal Radial Gates," Report REC-ERC-83-9, Bureau of Reclamation, Denver CO, December 1983.

Christiansen, J.E., "Measuring Water for Irrigation," Bulletin 588, University of California, Berkley CA, 1935.

Franke, P.G., and F. Valentin, "The Determination of Discharge Below Gates in Case of Variable Tailwater Conditions," *Journal of Hydraulic Research*, Vol. 7, No. 4, Delft, The Netherlands: International Association for Hydraulic Research, 1968.

Henry, H., "Discussion Diffusion of Submerged Jets," *Transactions of American Society of Civil Engineers*, Discussion 115, 1950.

Kruse, E.G., "The Constant-Head Orifice Farm Turnout," ARS 41-93, Agricultural Research Service, U.S. Department of Agriculture, January 1965.

Schuster, J.S. (ed.), "Water Measurement Procedures, Irrigation Operators' Workshop," Report No. REC-OCE-70-38, Bureau of Reclamation, Denver CO, September 1970.

CHAPTER 10 - CURRENT METERS

1. Introduction

Current meters are velocity measuring devices that sample at a point. Each point velocity measurement is then assigned to a meaningful part of the entire cross section passing flow. The velocity-area principal is used to compute discharge from current-meter data. Total discharge is determined by summation of partial discharges. Data are usually determined over a useful range of total discharges. These discharges are related to measured water surface elevations related to a fixed head measuring device to provide a rating curve. After full confidence in the rating is attained, the calibrated head measurement device and cross section may be used as a gaging station.

2. Classes of Current Meters

Several classes of current meters are used in water measurement.

- Anemometer and propeller velocity meter
- Electromagnetic velocity meters
- Doppler velocity meters
- Optical strobe velocity meters

Most of these will be discussed briefly here. The class that is more commonly used for irrigation and watershed measurements is the anemometer and propeller type; however, the use of electromagnetic velocity meters is very popular among water districts. The discussion in the following sections will mainly describe this class and its use.

(a) Anemometer and Propeller Current Meters

Anemometer and propeller current meters are the most common type used for irrigation and watershed measurements. These meters use anemometer cup wheels or propellers to sense velocity. The Price current meter and the smaller pygmy meter modification are the most common current meters in use. These meters are rated by dragging them through tanks of still water at known speeds. The reliability and accuracy of measurement with these meters are easily assessed by checking mechanical parts for damage and using spin-time tests for excess change of bearing friction. This type current meter does not sense direction of velocity, which may cause problems in complicated flow where backflow might not be readily apparent. For irrigation needs, this problem can be avoided by proper gage station or single measurement site selection.

(b) Electromagnetic Current Meters

Electromagnetic current meters produce voltage proportional to the velocity. The working principle of these meters is the same as the pipeline electromagnetic flowmeter, which is more fully described in chapter 14. One advantage of these current meters is direct analog reading of velocity; counting of revolutions is not necessary. These current meters can also measure crossflow and are directional. Electromagnetic current meters, while still not as reliable as the anemometer type, have improved greatly in recent years. Their use near metallic objects is still a limitation.

(c) Doppler Type Current Meters

Doppler type current meters determine velocity by measuring the change of source light or sound frequency from the frequency of reflections from moving particles such as small sediment and air bubbles. Laser light is used with laser Doppler velocimeters (LDV), and sound is used with acoustic doppler velocimeters (ADV). The working principles for ADV type flowmeters are more fully described in chapter 11. Acoustic Doppler current profilers (ADCP) have also been developed. These instruments measure average velocities of cells of selected size in a vertical series. Thus, they measure vertical current profiles. ADCP measurements are becoming more frequent for deep flow in reservoirs, oceans, and large rivers. Most of the meters in this class are multidimensional or can simultaneously measure more than a single directional component of velocity at a time.

(d) Optical Strobe Velocity Meters

Optical strobe velocity meters developed by the U.S. Geological Survey (USGS) and the California Department of Water Resources use optical methods to determine surface velocities of streams (USGS, 1965). This meter uses the strobe effect. Mirrors are mounted around a polygon drum that can be rotated at precisely controlled speeds. Light coming from the water surface is reflected by the mirrors into a lens system and an eyepiece. The rate of rotation of the mirror drum is varied while viewing the reflected images in the eyepiece. At the proper rotational speed, images become steady and appear as if the surface of the water is still. By reading the rate of rotation of the drum and knowing the distance from the mirrors to the water surface, the velocity of the surface can be determined. The discharge rate of the stream may be estimated by applying the proper coefficient to this surface velocity and multiplying by the cross-sectional area of the flow section.

The meter has several advantages. No parts are immersed in the flowing stream. Moreover, it can be used for high-velocity flows and for flows carrying debris and heavy sediment. The meter can measure large flood flows from bridges. However, the meter measures only the water surface velocity and is very dependent upon the selection of the proper coefficient.

3. Use of Current-Meter Gaging Stations

Current-meter gaging stations are permanent or semi-permanent stations located along a watercourse where flow conditions permit the establishment of a discharge rating curve based upon multiple current-meter measurements. After the rating curve has been established, the rate of flow is determined from the curve based on the measured depth of flow at the station. If measurements become necessary in existing streams or canals, current-meter gaging stations can be set up with relatively little effort and usually without modification to the channel.

Current-meter gaging stations are often preferred over other means of water measurement when large flows are to be measured and head loss is costly, or when freeboard is not available. They may also be desirable for sediment-laden flows even when discharges are not large. However, excess sediment and seasonal growths of weeds can change head versus discharge relationships, requiring frequent preparation of new rating curves. The frequent rating shifts can become labor intensive, and flumes may be the better choice.

Where flow depths are too small for current meters and only small heads are possible, flumes are probably the best alternative measuring method.

The discussion of current meters, gaging stations, and operational procedures presented in this chapter is brief and is intended mainly to stress the more typical irrigation water measurements that may be made by this method. For more detailed information, refer to USGS Water Supply Paper No. 888 (USGS, 1965), Buchanan and Somers (1969), the National Handbook of Water-Data Acquisition (USGS, 1980), and Wahl et al. (1995).

4. Location of Current-Meter Stations

Whenever possible, current-meter gaging stations should be located in straight, uniform stretches of channel having smooth banks and beds of permanent nature. The station should be located far from flow disturbances caused by turnouts and power stations. These flow disturbances will variably affect the relationship of discharge to gage height. In many channels, these conditions are difficult to find, and unusual care must be taken to obtain a satisfactory location.

The changing nature of some rivers and canals may require frequent current-meter measurements. Sand shifts may occur frequently, often daily, and aquatic weeds may continue to grow and increase in area. To obtain the gage-discharge relationship at stations on such streams, current-meter measurements may be necessary two or three times weekly or perhaps daily if the importance of equitable water distribution justifies such action. A rating section consisting of a short-lined section in a straight stretch of channel will ensure a meter station of unvarying dimensions if the sediment problem is not serious. Such a section in a canal is shown on figure 10-1.



Figure 10-1 -- Current-meter station on a canal, viewed from upstream. Current-meter measurements are taken from the bridge, and the sheltered stilling well houses an automatic water-stage recorder.

A gaging station located upstream from any permanent single control section, such as a drop, will usually have a simple relationship between the gage height and discharge. A gaging station located in a river may have successively changing control points downstream as discharge increases or decreases, resulting in more complicated gage height versus discharge relationships. The last two types are not commonly used in irrigation practice and will not be discussed.

5. Types of Current-Meter Measurements

Current-meter discharge measurements are classified according to the type of equipment used and the nature of the station:

- Wading measurement (figure 10-2).
- Cable supported measurement (figure 10-3).
- Bridge measurement (figure 10-4).
- Boat measurement (figure 10-5).
- Measurement through ice cover.



Figure 10-2 -- Equipment for making wading measurements with a current meter. Note tag line for marking stations.



Figure 10-3 -- Current-meter gaging station with cable car, corrugated steel shelter house, and stilling well.



Figure 10-4 -- Type A crane and current-meter assembly in position on bridge.



Figure 10-5 -- Making a current-meter measurement from a boat.

6. Current-Meter Stations and Handling Equipment

The essential components of a current-meter station are a water-level gage (stage recorder), a bench mark, fixed measuring points in the channel cross section, and a stay line to hold the meter in the measuring plane or cross section under high velocity and deep water. Water stages or elevations can be obtained by non-recording gages or water-stage recorders. The gage types most commonly used in irrigation water measurement are the graduated, enameled, vertical staff, hook, and float. A commonly used staff gage is shown on [figure 8-4](#) in chapter 8. Float gages are often connected to water stage recorders that produce charts of the water surface variations against time. The benchmark should be conveniently and permanently located, with the elevation of the gage datum carefully referenced to the benchmark.

Velocity measurement points should be located in a cross-section plane which is oriented perpendicular to the channel flow. Where the channel is shallow enough to permit wading measurements or where cable-supported measurements are taken, a tagged wire should be used to establish the measuring points. When measurements are made from a bridge, permanent measuring points should be established upon the bridge. The measuring points should be permanently marked at equal intervals of from 2 to 10 feet (ft), depending upon the width of the stream or canal. If the stream velocity is high or if the structure from which the measurements are being made is far above the water, a stay-line can be used to pull the current meter back into the plane of the measurement cross section. A cable supporting a traveling pulley can be stretched across the canal upstream from and parallel to the measuring cross section. The traveling pulley is fitted with a swiveling stay-line pulley. The stay-line runs from the meter hanger, through the swiveling pulley, and back to the operator at the measuring station. The support cable is placed perpendicular to the flow velocity and far enough upstream so when the current meter is pulled back into the vertical plane at the measurement station, the slope of the stay-line relative to the water surface is flatter than 30 degrees.

Streamlined weights with large tail fins, commonly called Columbus or C-type weights, are used to carry the meter down into the flow and help hold it in the desired position when measurements are being made from a bridge or a cable. Weights are available in 15-, 30-, 50-, 75-, 100-, 150, 200-, 300-, and 500-pound (lb) sizes. Usually, weights of 75 lb or less are adequate for canal and small stream measurements. To handle the relatively heavy current-meter and weight assembly, the type A portable crane shown on [figure 10-4](#) is used. This crane is mounted on three wheels designed to hold the current meter and weight in a balanced position while moving between measuring points.

For stream measurement, the crane is tilted to lean against the bridge rail so the boom supports the meter and weight clear of the bridge. The meter is raised and lowered by a crank and cable reel on the frame. The crane may be folded into a compact unit for ease in transportation.

A cable device used extensively to position current meters across canals is shown on figure 10-6. The head tower with the operating mechanism for the cable and the tail tower on the opposite bank can be fixed installations, or vehicles may function as anchors on each side of the canal. A counter on the head tower reel determines the lateral position of the traveling block. Another counter on the reel raises and lowers the meter and determines meter depth. The entire installation is relatively inexpensive and permits stream gaging to be done safely and easily from the bank.



Figure 10-6 -- Cableway with traveling block to support the current meter and position it for readings. Counters are provided on the head tower and reel to determine the position of the meter in the channel.

A carriage and track system to handle current meters with heavy weights when working from bridges is shown on figure 10-7. The standard reel and counter assembly is mounted on a carriage supported by ball-bearing rollers that run on a 2- by 6-inch (in) timber track permanently mounted on the bridge rail. This equipment allows the operator freedom of movement with safety, facilitates obtaining accurate stream gaging data, and is easily portable from one station to another.



Figure 10-7 -- Carriage and track for handling current meter and weights from a bridge. A 2- by 6-in timber permanently attached to the bridge rail is the track for the portable, wheeled carriage that supports the reel, cable, and meter assembly.

7. Subclasses of Anemometer-Propeller Current Meters

These commonly used current meters convert velocity into counts of rotations. Conventional meters are of two general types - the propeller type with horizontal axis of rotation and the conical cup type with vertical axis. The relationship between the velocity of the water and number of revolutions per unit of time for various velocities is determined for each instrument by experiment. Individual meters of models that have had long and extensive use without structural or mechanical changes can use previous experimental calibrations with confidence. This procedure requires tight control during manufacture with close tolerances for mechanical part dimensions and verification with time-spin tests.

The manufacturer should provide the appropriate calibration equations, tables, or curves with each meter. A sample rating table is shown on figure 10-8 for a meter with the equations:

$$V = 2.14N + 0.03 \quad \text{for } N < 1.00 \quad (10-1)$$

and

$$V = 2.19N + 0.01 \quad \text{for } N > 1.00 \quad (10-2)$$

In these equations, V is the velocity in feet per second (ft/s), and N is the number of revolutions per second.

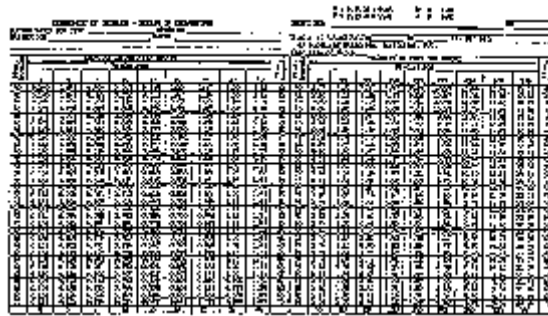


Figure 10-8 -- Typical current-meter rating table.

Each meter is calibrated for the types of suspensions with which it may be used (Smoot, 1968). The two principal types of suspensions are wading rod and cables (shown on [figures 10-2](#) and [10-4](#), respectively).

Because accuracy is greatly affected by general condition, the instrument should be checked at least once a year. This check can be done by comparing the meter readings with a second meter by placing it in the same position in a non-changing flow. This procedure is done at low, middle, and high velocity to cover the meter measuring range. If significant difference exists between the two meter readings, or if another meter is not available for checking to begin with, then the meter should be sent to a laboratory for calibration.

(a) Price-Type Meters (Vertical Axis)

The Price meter, a cup-type instrument with a vertical axis, was developed by USGS and is commonly used for irrigation water measurement.

This meter has the following general features: vanes to keep the front of the meter headed into the current, either a cable or a rod for handling the meter, weights for sinking the meter when it is suspended on a cable, an electric device for signaling and/or counting the number of revolutions, and connections from the current meter to a 12-volt battery-powered headphone (figure 10-9).

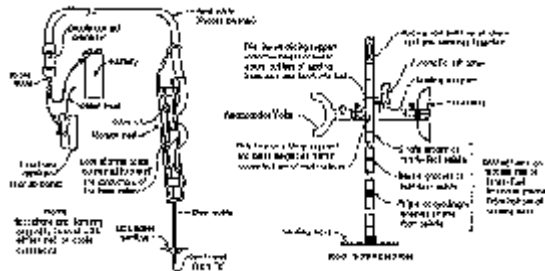


Figure 10-9 -- General assembly of Price type AA current meter (sheet 1 of 2).

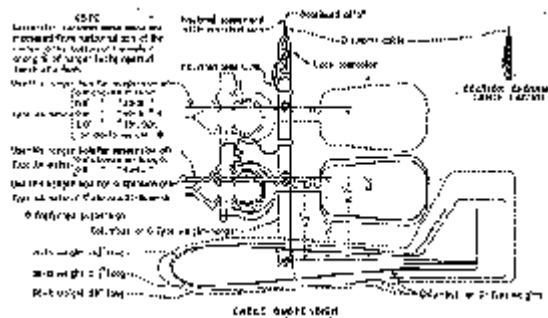


Figure 10-9 -- General assembly of Price type AA current meter (sheet 2 of 2).

The Bureau of Reclamation (Reclamation) commonly uses two standard Price-type meters: (1) the type AA meter with the Columbus-type weights or a wading rod, and (2) the type BTA meter

(figures 10-10 through 10-13). The pygmy meter, discussed in the following subsection, is also a modification of the standard Price meter. The BTA meter has the same pivot, hub assembly, and shaft as the type AA meter, which eliminates the need for two sets of spare parts. The parts for type AA and BTA meters are interchangeable, except for the yoke and the contact chamber. Two sets of revolution-indicating contacts are provided in the type AA and BTA meters; one set indicates every five revolutions. The electrical cable should be connected to the counter most appropriate for the anticipated bucket wheel speeds. A type AA meter on a wading rod is shown on figure 10-13.

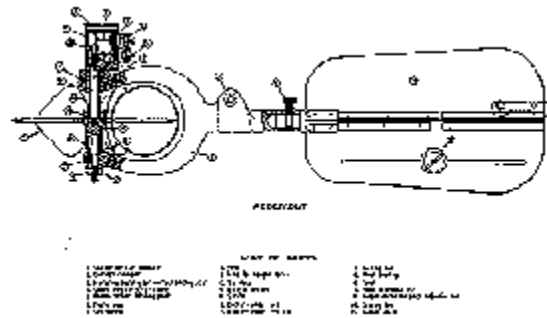


Figure 10-10 -- Assembly drawing of Price type AA current meter.

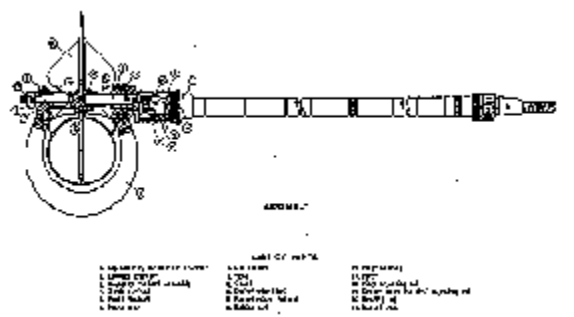


Figure 10-11 -- Assembly drawing of Price type BTA current meter.

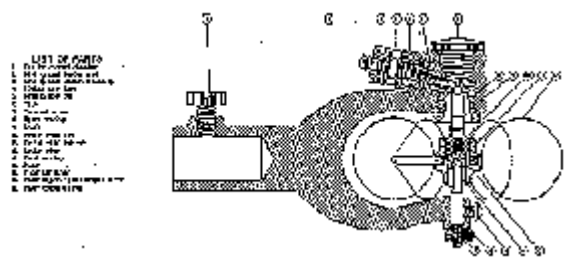


Figure 10-12 -- Assembly drawing of pygmy-type current meter.

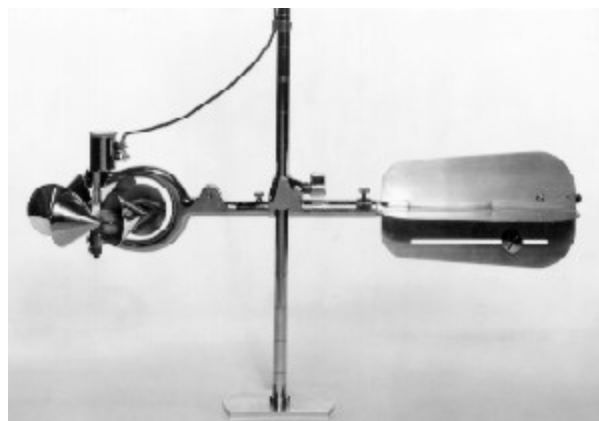


Figure 10-13 -- Price type AA current meter on a round wading rod.

An improved contact chamber has been developed by USGS to replace the wiper contact of the Price type AA meter (USGS, 1965). The new chamber contains a magnetic switch that is hermetically sealed in a hydrogen atmosphere within a glass enclosure. The switch assembly attaches rigidly to the top of the meter head just above the tip of the shaft. The switch is operated by a small permanent magnet fastened to and in balance with the shaft. The switch quickly closes when aligned with the magnet and promptly opens when the magnet moves away. One count per revolution is obtained.

The magnetic switch can be used on any type AA meter by replacing the shaft and the contact chamber. The change does not alter the rating of the meter. Headphones must not be used with the new switch because arcing can weld the switch contacts. Instead, an automatic counter should be used (USGS, 1965).

(b) Pygmy Meters (Vertical Axis)

Pygmy meters are similar to Price meters in that both contain a cup-type wheel mounted on a vertical shaft. The pygmy cup wheel is 2 in in diameter, compared with 5 in for conventional Price meters. Thus, the pygmy meter can measure velocities closer to flow boundaries. The contact chamber is an integral part of the yoke and contains a single-revolution contact only (figure 10-12). The meter has no tailpiece, and no provision is made for cable suspension. The rotational speed of the pygmy meter cup wheel is more than twice that of Price meters. Consequently, use of the pygmy meter is limited to velocities up to 3 or 4 ft/s. The pygmy meter was specially designed for use in small, shallow streams. The smaller meter was necessary because a standard

Price meter does not perform with sufficient accuracy when it occupies a good share of the available stream depth. The pygmy meter may also be used in large canals where the velocity of flow is low or near the edges of a canal to supplement data taken farther out in the channel with a Price meter.

(c) Propeller Meters (Horizontal Axis)

In special situations, Reclamation has used meters of the propeller type with horizontal axles. Hoff meters, Haskell meters, Ott meters, and Neyrpic "Dumas" meters are examples. A Dumas meter and electrical output cable attached to a support rod are shown on figure 10-14a. An assembly of eight Dumas meters with appropriate handling equipment is shown on figure 10-14b. In this case, the equipment was mounted on a flatbed truck for positioning. These meters have some advantages compared to the Price meters. They are less sensitive to velocity components not parallel to the meter axis, they are smaller, and they are more suited for mounting in multiple units.

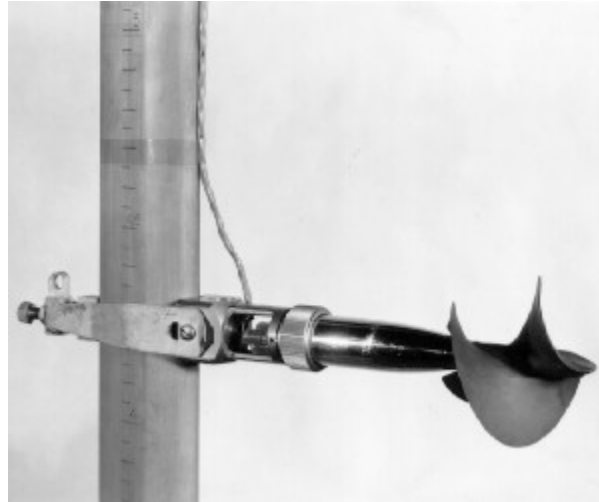


Figure 10-14a -- "Dumas" current meter of the propeller type with horizontal axle. Hott and Ott meters are of the same type.



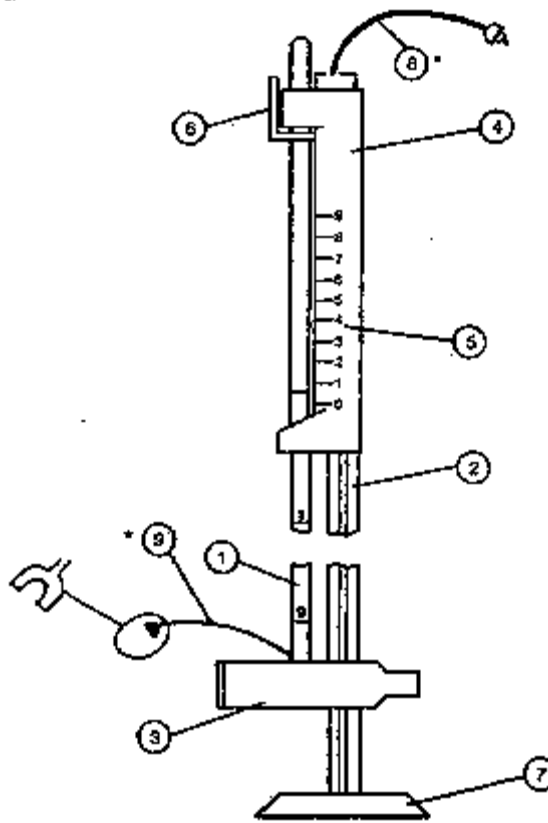
Figure 10-14b -- Truck-mounted assembly of eight propeller-type current meters and signal recording equipment used on Gateway Canal, Weber Basin Project, Utah.

8. Wading Rods

Two types of wading rods are available for supporting the current meters when working in shallow and moderate-depth streams: (1) the conventional round rod and (2) the more convenient top-setting rod. Both rods use a baseplate that rests on the bottom of the flow channel.

The round rod ([figure 10-13](#)) consists of several sections of 1-ft-long, 2-in-diameter, nickel-plated round brass tubing. The rod is graduated at intervals of 0.1 ft by shallow machined lines around the rod. A single groove is used at the 0.1-ft graduations, double grooves at the 2-ft intervals, and triple grooves at the foot marks. A nickel-plated sliding support machined from a bronze casting moves up or down on the rod and is held at any desired location by a spring-actuated lock which uses a lever for release. The current meter and the vanes, if used, attach to this sliding support.

The top-setting wading rod (figure 10-15) permits all settings to be made in the dry and has a main column of 2-in hexagonal stock and a meter positioning rod of d-in-diameter stock. The main rod attaches to the baseplate and is graduated in 0.1-ft intervals so depth of flow can be measured. Interval markings are the same as those used on common wading rods. The meter is secured to the lower end of the positioning rod and guided by means of a support that slides on the main rod. The position of the meter and sliding support is set by raising or lowering the positioning rod which extends through the handle at the top of the main rod. When the elevation of the meter is set to read the depth on the vernier, it will be at the 0.6 depth position. Doubling the vernier reading puts the meter at the 0.2 depth, and halving puts it at 0.8 depth. Once set, the positioning rod, and hence, the sliding support and meter, is secured by a locking device on the handle. Thus, all adjustments are made from above water so the operator's hands and the log can remain dry.



- (1) The 3/8" diameter Aluminum rod.
- (2) The 1/2" Hexagon Stainless Steel rod.
- (3) The Sliding Support.
- (4) The Handle.
- (5) The Vernier.
- (6) The Trigger.
- (7) The Base.
- (8) The Wire Assy. - Handle.*
- (9) The Wire Assy. - Meter.*



Figure 10-15 – Top setting wading rod.

9. Care of Propeller Meters

Current meters must receive the best care during transportation and use to ensure accurate velocity measurements. Particular care should be taken when working near bridge piers and abutments, floating debris or ice, and also when measurements are being taken at irregular or unknown sections and the meter is suspended on a measuring line. If the cups or blades become bent or damaged, the results obtained from the rating curve for the meter will be unreliable. After completing the measurements at a rating station, the meter should be carefully cleaned. After each day's use, it should be properly lubricated.

The Price-type meters have special cases for storage when the meter is not in use. For damage protection, the cup wheel should be supported firmly on the resting pin that replaces the needle bearing while the meter is stored or being transported. Meter damage has occurred because of improper packing and careless handling in transportation. The meter case should be substantial and rigid with properly fitted interior supports to prevent movement and damage to the delicate parts.

10. General Procedures and Precautions

Accuracy of measurement can be maintained by observing the following precautions for Price meters (including the pygmy meter modification of the Price meter):

- The meter should be spin tested before and after completing measurements to assure that the meter has no error-causing damage. With the shaft in a vertical position and the cups protected from air currents, the cups should be given a quick turn to start them spinning. If the meter is in proper adjustment and the bearings are free from foreign particles, the cups should come to rest in not less than 3 minutes. If the length of spin is only about 12 minutes, but the cup wheel comes to rest gradually, all flows except those of very low velocities may be measured. If the length of spin is only about 1 minute but the cup wheel comes to rest gradually, the meter may still be used to measure velocities above 1 ft/s. If the length of spin is less than 1 minute, the meter should be reconditioned. Under laboratory controlled conditions, rotation should continue for about 4 minutes. The manner in which rotation ceases will help indicate the condition of the meter and should be observed.
- The cross section of the stream should be divided vertically into 20 or more segments. Very small streams and sections with smooth, firm boundaries are exceptions, and a smaller number of stream cross-section segments would be sufficient. A single vertical reading is used if the distance between verticals is less than 1 ft. Horizontal divisions are generally selected so not more than 10 percent, and preferably not more than 5 percent, of the discharge will occur between any two adjacent verticals.
- The stopwatch should be checked frequently and kept in good condition.
- For low and irregular velocities, the period of observation should be lengthened to obtain a more accurate average count.
- The current meter should be withdrawn from the water between velocity readings to make sure that rotation is not being impeded by debris or any other cause.
- The meter should be allowed at least 10 to 20 seconds to attain rotation speed before counting commences.

- The total operation of the meter at each elevation of a vertical should consist of at least two consecutive periods of at least 40 seconds. If significant differences are apparent in each period, more readings should be taken.
- Measurements while wading should be done facing the bank, standing just downstream from the tag line, and at least 18 in to the side of the meter.

11. Method of Measurement

Depth sounding, either with a meter and rod assembly or with a special sounding line and weight, should first be made at each of the permanent measuring points. These depths should be properly recorded. Next, the mean velocity at each of the measuring points should be determined with the current meter by one of the methods listed in the following section. Velocity measurements should be properly recorded.

Errors of velocity measurement will arise if the current meter:

- Is placed closer to the boundary than 1-2 rotor diameters
- Is used to measure velocities less than 0.5 ft/s or out of the range of calibration.
Overdriving the rotor can damage bearings
- Is not held steady in one position during the time measurement
- Is used in significant waves, such as those caused by wind
- Is used in flow which is not parallel to the axis of the propeller meter or is oblique to the plane of the cup-type meter
- Is impeded by weeds or debris

12. Methods of Determining Mean Velocities

The following methods are used to determine mean velocities in a vertical line with a current meter:

- Two-point method
- Six-tenths-depth method
- Vertical velocity-curve method
- Subsurface method
- Depth integration method
- Two-tenths method
- Three-point method
- One-point continuous method

The two-point method consists of measuring the velocity at 0.2 and then at 0.8 of the depth from the water surface and using the average of the two measurements. High accuracy is obtainable with this method, and its use is recommended. However, the method should not be used where the depth is less than 2 ft.

The six-tenths-depth method consists of measuring the velocity at 0.6 of the depth from the water surface and is generally used for shallow flows where the two-point method is not applicable. The method gives satisfactory results.

The vertical velocity-curve method consists of measuring the velocities at enough vertical positions so that the velocity profile is defined well enough to calculate a sufficiently accurate mean velocity. The method is very accurate, depending upon the number of data points measured for profile, but is time consuming and costly.

The subsurface method involves measuring the velocity near the water surface and then multiplying it by a coefficient ranging from 0.85 to 0.95, depending on the depth of water, the velocity, and the nature of the stream or canal bed. The difficulty of determining the exact coefficient limits the usefulness and accuracy of this method.

The depth or traveling integration method is performed by observing the velocity along a vertical line by slowly and uniformly lowering and raising the meter throughout the range of water depth two or more times. The method is not accurate and should be used only for comparisons or quick, rough checks.

The two-tenths, three-point, and one-point continuous methods are special procedures based on a relationship - previously established for the section - between the true discharge and the velocities observed by these methods. These methods are generally reliable for sections which undergo no serious changes because of erosion, sedimentation, or other deformation. They are discussed in detail in USGS (1965) and USGS (1980). Of the methods cited in this section, the two-point method and the six-tenths-depth method are most used in canal work.

13. Computing Discharge

The velocity-area principle is used to compute discharge from current-meter data. Total discharge is determined by summation of partial discharges. A partial discharge is the product of an average point or vertical line velocity and its meaningfully associated partial area, expressed as:

$$q_n = \bar{v}_n a_n \quad (10-3)$$

The total discharge is then:

$$Q = \sum_1^n (\bar{v}_n a_n)$$

The simple average, the midsection method, and Simpson's parabolic rule applied to both the depth and average vertical line velocity values will be discussed using figure 10-16. This figure shows: (a) where the boundary is broken up into inflecting straight line sections and (b) where the boundary is smoothly curved.

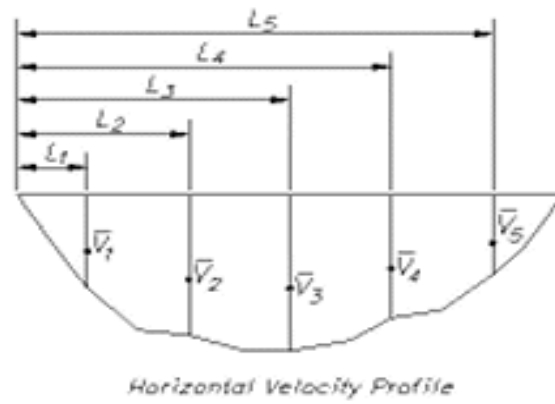
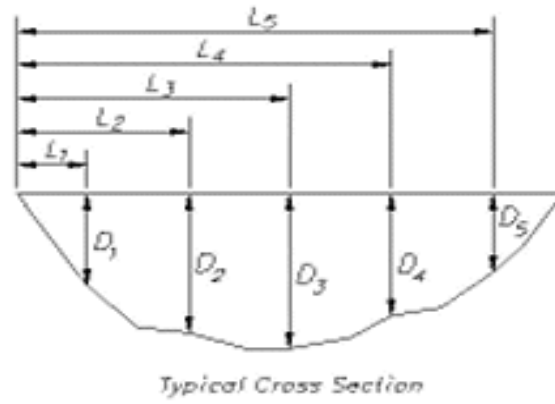


Figure 10-16a -- Calculation of discharge using the midsection method.

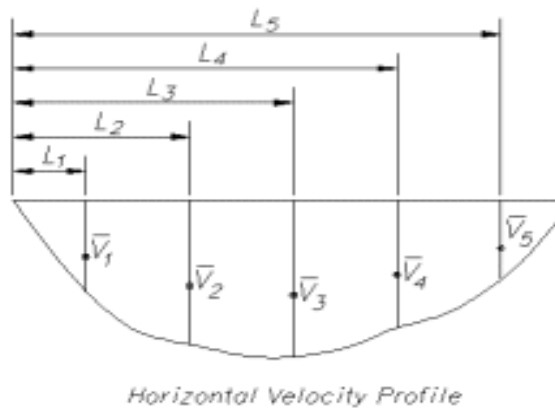
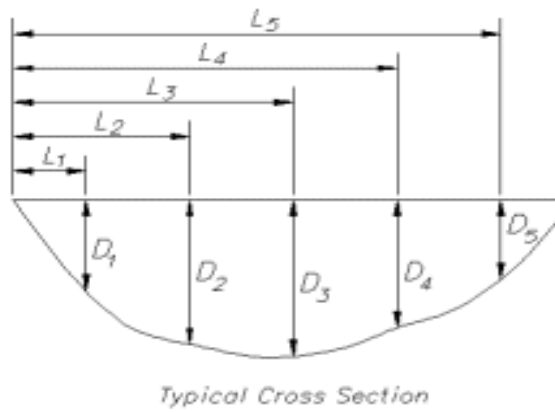


Figure 10-16b -- Calculation of discharge using Simpson's parabolic rule method.

The measured and computed variables are as follows:

q = the discharge in cubic feet per second (ft³/s) for a partial area

Q = total discharge

\bar{V} = the mean velocity associated with the partial area

a = partial area of total cross section

L_1, L_2, \dots, L_n = distance to vertical measurement locations in feet from an initial point to vertical station

ΔL = the distance in feet between consecutive vertical measurement stations

$\bar{V}_1, \bar{V}_2, \dots, \bar{V}_n$ = the respective mean velocities in feet per second at vertical measurement stations

D_1, D_2, \dots, D_n = the water depths in feet at verticals

n = the number of verticals related to the partial area

14. Simple Average Method

Using the simple average of two successive vertical depths, their mean velocity, and the distance between them results in:

$$q_{3-4} = \left[\frac{\bar{V}_3 + \bar{V}_4}{2} \right] \left[\frac{D_3 + D_4}{2} \right] (L_4 - L_3) \quad (10-5)$$

The two hyphenated integers as a subscript denote that the partial discharge, q , is for the area between two consecutive vertical measurement points as numbered.

15. Midsection Method

In the midsection method, the depth and mean velocity are measured for each of a number of verticals along the cross section. The depth at a vertical is multiplied by the width, which extends halfway to the preceding vertical and halfway to the following vertical, to develop a cross-sectional area. The product of this area and the mean velocity at the vertical gives the discharge for the partial section between the two halfway points. A summation of the partial discharges gives the total discharge. The formula for computing the partial discharge using the midsection method is:

$$q_{n\pm} = \bar{V}_n \left[\frac{(L_n - L_{n-1}) + (L_{n+1} - L_n)}{2} \right] D_n \quad (10-6)$$

The value, n , with plus and minus after it denotes that the partial discharge, q , is for the area between halfway back toward the previous vertical measurement and halfway toward the next forward vertical.

The mean velocities are determined by any one of the methods listed in section 12. For these two methods, the verticals do not need to be equally spaced, but the verticals should be chosen such that:

(1) The error of computing the area between the verticals does not exceed 3 percent when the bed is treated as straight lines between the verticals.

(2) Except at the banks, the difference between the mean velocities at the verticals does not exceed 20 percent relative to the lower velocity of a pair of verticals.

16. Simpson's Parabolic Rule

In this method, Simpson's parabolic rule is used twice to compute discharge using the area velocity method. First, the area is computed for three consecutive depths at velocity measuring stations using Simpson's rule. Second, average velocity for the same three verticals is computed by the rule. The discharge between the three verticals is the product of the average velocity and area. Using Simpson's rule assumes both the vertical depths and their corresponding average velocity vary parabolically ([figure 10-16b](#)). Natural riverbeds and older earth-lined canal bottoms follow curved shapes rather than the typical straight line geometry of hard-lined canal designs. Both vertical and horizontal velocity profiles tend to be parabolic in either case. Using Simpson's rule to obtain the area between three equally spaced consecutive verticals or two consecutive partial areas results in:

$$A_{n\pm} = \left(\frac{D_{n-1} + 4D_n + D_{n+1}}{3} \right) \Delta L \quad (10-7)$$

where Δ is the distance between consecutive vertical velocity measuring stations which are equally spaced across the flow section.

Using Simpson's rule to obtain the mean velocity of three consecutive verticals or over two consecutive partial areas is expressed as:

$$\langle \nabla_{n\pm} \rangle = \Delta L \left(\frac{\nabla_{n-1} + 4\nabla_n + \nabla_{n+1}}{3} \right) / 2\Delta L \quad (10-8)$$

The product of this velocity and the area from the previous equation results in the relationship for the discharge through the two consecutive partial areas, written as:

$$q_{n\pm} = (\Delta L \left(\frac{\nabla_{n-1} + 4\nabla_n + \nabla_{n+1}}{3} \right) / 2\Delta L) \left(\frac{D_{n-1} + 4D_n + D_{n+1}}{3} \right) \Delta L \quad (10-9)$$

Typical discharge computations obtained by the midsection method, equation 10-5, are illustrated on figure 10-17. Velocities were taken from the current-meter rating table on [figure 10-8](#).

Susque River near Martins, Maryland

Date July 6 Party O. J. Saffell
 Width 214 Area 1.140 Vel. 3.70 C. H. 6.70 Disch. 4.220
 Method 6.2-8 No. sec. 25 C. H. change 0 In. Step 30.0
 Method coef. 1.0 Hor. angle coef. 1.0 Susp. coef. 1.000 Meter No. 277950

Time	GAGE READINGS			Outside
	Incode	Incode	Incode	
1700	6.72	6.70	6.70	
1705	6.72	6.70	6.70	
1810	6.72	6.70	6.70	
Weighted M. C. H.	6.70			
C. H. measured				
Correct M. C. H.				

Date read 5-31-62 Used rating
 For rod temp. Meter ft.
 above bottom of wt. Taps checked
 Spin before read OK after OK
 Max. pile % diff. from rating
 Windy cable ice back up down side
 bridge feet with above below
 gaps and
 Check-bar, chain found
 changed to at
 Current
 Leads obtained

Measurement rated excellent (95%), good (85%), fair (65%), poor (over 8%) based on following
 condition: Cross section COBBLES
 Flow Weather
 Other Air °F
 Gage OK Water °F
 Round removed Inside checked
 Current
 Control
 Remarks
 C. H. of zero flow ft.

Figure 10-17 -- Typical current-meter notes and computations for the midsection method using equation 10-5 (sheet 1 of 3).

Elevation feet	Dist. from center feet	Width	Depth	Type of flow	Current m/s	Time in min.	Velocity		Adjusted for depth	Area	Discharge
							At point	At center			
	30	5	0		0	40		0		0	
	40	10	3.30	.8	60	47	3.25	2.79		36.0	95
				.8	50	48	3.33				
	50	10	4.70	.8	80	43	4.13	3.52		47.0	165
				.8	60	46	3.90				
	60	10	5.30	.8	80	48	4.13	3.75		53.0	198
				.8	60	40	3.77				
	70	10	5.80	.8	80	42	4.25	3.82		58.0	222
				.8	80	52	4.42				
	80	10	5.90	.8	80	49	4.53	3.97		59.0	231
				.8	60	32	4.47				
	90	10	5.90	.8	80	37	4.53	3.89		59.0	230
				.8	60	41	3.25				
	100	10	5.90	.8	80	40	4.23	4.04		59.0	238
				.8	80	50	3.55				
	110	10	6.00	.8	100	43	4.62	4.68		60.0	245
				.8	80	50	3.55				
	120	10	6.20	.8	100	48	4.62	3.98		62.0	247
				.8	60	40	3.75				
	130	10	6.25	.8	100	47	4.72	4.02		62.5	251
				.8	60	30	3.33				
	140	10	6.30	.8	100	38	4.62	3.90		63.0	246
				.8	60	42	3.18				
	150	10	6.70	.8	80	39	4.53	3.82		67.0	256
				.8	60	43	3.10				
	160	10	6.90	.8	80	42	4.25	3.81		69.0	242
				.8	60	48	2.79				
	170	10	6.30	.8	80	42	4.25	3.66		63.0	232
				.8	60	43	3.10				
	180	10	6.10	.8	80	41	4.33	3.87		61.0	236
				.8	60	30	3.47				

Figure 10-17 -- Typical current-meter notes and computations for the midsection method using equation 10-5 (sheet 2 of 3).

This change in flow capacity of the canal for a given depth of flow must be taken into consideration when computing the quantity of water carried by the canal. If the canal is cleaned during the season, the relationship of discharge to gage height is again disturbed. The changing relationship of discharge to gage height in irrigation canals caused by changing boundary conditions is the chief source of error in flow measurements.

18. Gage Readings

To determine the quantity of water carried by a canal over a period of time, the gage must be read at least twice daily. More than one reading provides a means for checking the readings and also informs the canal attendant of any unexpected changes in canal stage. More frequent readings are needed when changes in stage are suspected or are made in the canal. The readings should be taken by the canal attendant on regular rounds. The gage should be read accurately, generally to the nearest hundredth of a foot. Automatic water-stage recorders eliminate the need for numerous readings and can increase the accuracy of the flow measurements.

19. Computations of Discharges

Current-meter measurements made at several specific flows can be used to obtain discharge, velocity, and area curves that apply to all inclusive gage heights by plotting the appropriate data on cross-section or graph paper (figure 10-18). Discharges, corresponding mean cross-sectional velocities, and cross-sectional areas are plotted on the horizontal axis. Corresponding gage heights are plotted on the vertical axis. Three separate curves are drawn through these data points.

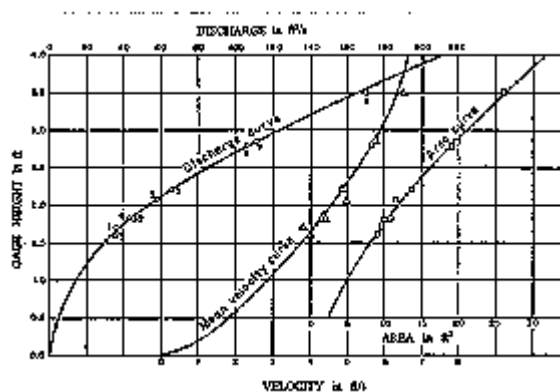


Figure 10-18 -- Typical discharge, mean velocity, and area curves for a canal.

The probable area curve is established first by drawing the most probable line through the data points. Using this curve, the accuracy of the area computations and of the flow depth measurements may be checked. Next, the computed mean cross-sectional velocities are plotted, and a curve is drawn through the points. This curve provides a check on the velocity computations and helps detect changes in velocity that may occur in the canal because of changing roughness or silting in the canal.

Finally, the discharge curve is drawn through the computed discharge points. If flow conditions in the channel did not change resistance significantly during the period needed for measurements over the full range of canal flows, the curve will generally be easy to draw.

If the relationship of discharge to gage height was affected by growths or sediment deposits, one or more additional discharge curves must be drawn. The number of rating curves required for a cross-section location depends upon the degree of the flow restrictions encountered and the rate at which the restrictions developed. These curves will generally be parallel to, but slightly displaced from, the curve for the clean canal. For the periods when the change is in progress, discharges may be estimated by proportioning between curves for the clean and restricted conditions on a time basis.

20. Rating Table

From the rating curve, a rating table may be prepared for each tenth or hundredth of a foot of gage height from zero to the maximum height of water in the canal or stream. For canals affected by growths or sediment, two or more such rating tables will be necessary, one for early in the season when the canal is clean, and the other for late in the season when growths or other restrictions are present. If the canal is cleaned during the irrigation season, operating personnel should be instructed to switch to the curves and tables for the clean canals.

21. Daily and Monthly Discharges

Discharges in acre-feet may be compiled from the daily gage heights and the rating tables. From these tables, the monthly discharges and the total amount of water delivered by the canal during the irrigation season may be obtained.

22. Measuring Discharges From Pipes With Current Meters

Propeller-type current meters have been used with limited success to measure rates of flow discharging from full pipelines (Rohwer, 1942). Measurements are made by traversing the pipe outlet with the meter to obtain an average velocity and then multiplying this velocity by the pipe cross-sectional area and by a correction coefficient. This coefficient has a value less than 1.0 because the meter traverses do not adequately measure flows close to the pipe walls and give a velocity measurement higher than the true average.

Accuracies within +/-5 percent can be obtained when the velocity of flow is enough to operate the meter but is less than 9 or 10 ft/s, provided the flow occurs without significant spiral flow, the discharge pipe is long enough to produce relatively uniform distributed flow, and the inside diameter of the pipe can be measured accurately. Velocities that are too high or too low, swirling flows, velocity concentrations, and pipelines not flowing full or carrying air reduce the accuracy obtainable. Also, the presence of the meter in the pipeline exit partially obstructs the flow. This obstruction reduces the rate of flow and increases the head in the pipeline. The effect is relatively small, but a correction factor is necessary to obtain best accuracies. In general, the method gives quick, comparative results but is not recommended where accurate flow measurements are needed. A simple, low, flat-crested, long-throated measurement structure (chapter 8) would be an accurate method to measure flow from a partially full pipe.

23. Bibliography

Buchanan, T.J., and W.P. Somers, "Stage Measurement at Gaging Stations," chapter 10, book 1, *Surface Water Techniques Series*, U.S. Geological Survey, Washington DC, 1965.

Buchanan, T.J., and W.P. Somers, "Discharge Measurements at Gaging Stations," *U.S. Geological Survey Techniques Series*, Water-Resources Investigation, Book 3, A8, 65 pp., 1969.

Rohwer, C., *The Use of Current Meters in Measuring Pipe Discharges*, Technical Bulletin 29, Agricultural Experiment Station, Colorado State University, Fort Collins, CO, 1942.

Smoot G.F., and C.E. Novak, "Calibration and Maintenance of Vertical-Axis Type Current Meters," *U.S. Geological Survey Techniques*, U.S. Department of the Interior, U.S. Geological Survey, 1968.

U.S. Geological Survey, "Describing Methods and Practices of the Geological Survey, Discharge Measurements at Gaging Stations," Water Supply Paper No. 888, Book 1, Chapter 11, 1965.

U.S. Geological Survey, Office of Water Data Coordination, *National Handbook of Recommended Methods of Water-Data Acquisition*. Prepared cooperatively by agencies of the U.S. Government, Government Printing Office, Washington DC, 1980.

Wahl, K.L., W.O. Thomas, Jr., and R.M. Hirsch, "The Stream-Gaging Program of the U.S. Geological Survey," Circular 1123, U.S. Geological Survey, Washington DC, 1995.

CHAPTER 11 - ACOUSTIC FLOW MEASUREMENT

1. Transit-Time Acoustic Flowmeters

Transit-time acoustic (ultrasonic) flowmeters are based on the principle that transit time of an acoustic signal along a known path is altered by the fluid velocity. A high frequency acoustic signal sent upstream travels slower than a signal sent downstream. By accurately measuring the transit times of signals sent in both directions along a diagonal path, the average path velocity can be calculated. Then, knowing the path angle with respect to the direction of flow, the average axial velocity can be computed (figure 11-1).

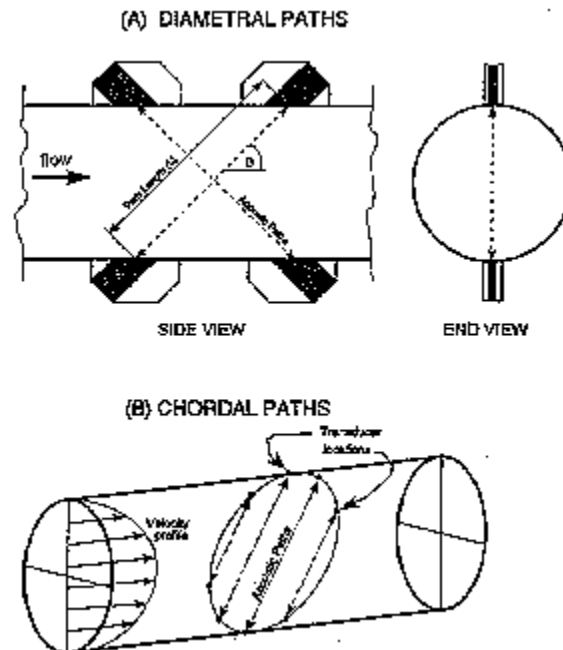


Figure 11-1 -- Transit-time acoustic flowmeters.

An acoustic flowmeter is a non-mechanical, non-intrusive device which is capable of measuring discharge in open channels or pipes. These flowmeters can provide continuous and reliable records of flow rates over a wide range of conditions including flow in both directions. Some typical applications include:

- Acceptance testing of hydraulic machinery (turbines and pumps).
- Flow measurement in conduits of large (360 inch [in]) and small (1/2 in) diameter.
- Hydroelectric powerplant management.
- Volumetric metering.
- Wastewater or water treatment plants.
- Laboratory and field calibration of other flow measurement devices.

Two common methods are used to calculate discharge using acoustic flowmeters:

(a) Diametral-Path Flowmeter

One or more pairs of acoustic transducers are mounted diametrically opposed in the measurement section (figure 11-1a). An average axial velocity is measured along each acoustic path, and volumetric flow rate is computed based on the known cross-sectional area of the conduit. This technique is based on an assumption that the velocity profile shape in the measurement section is very similar to a fully developed, turbulent velocity profile. As a result, flowmeter accuracy depends on how well the actual velocity profile compares to the assumed profile. A poor velocity profile will result in flow measurement errors.

A modification of the diametrically opposed, single-path flowmeter uses the opposite inside wall of the pipeline to reflect the acoustic signal to the receiving transducer. The transducers are tightly secured with straps on the same side of the pipeline. Transducer spacing depends on pipe diameter and wall thickness. Accuracy can be within +/-2 percent of actual under good conditions.

(b) Chordal-Path Flowmeter

This type of flowmeter uses four or more acoustic paths which are mounted on chordal paths across the measurement section (figure 11-1b). The average axial velocity component for each acoustic path is used to establish the velocity profile. The velocity profile is then numerically integrated over the conduit's cross-sectional area to determine the volumetric flow rate. As a result, flowmeter accuracy is relatively independent of the velocity profile. Furthermore, this type of flowmeter does not require calibration to reach the manufacturer's specified accuracy (usually between 0.5 to 2 percent of the flow rate).

The following advantages and disadvantages identified for acoustic flow measurement are discussed below.

(c) *Advantages*

- High accuracy, which can be achieved independent of velocity profile, flow rate, and liquid temperature.
- Bidirectional flow measurement capability.
- Non-intrusive, incurring no head loss.
- Field calibrations are generally not required.
- System cost is almost independent of pipe size.
- No moving parts and easily serviceable.

(d) *Disadvantages*

- Relatively high initial cost.
- Requires electronic technician to troubleshoot and service.
- Must be programmed for each pipeline material, diameter, and wall thickness.
- Entrained gases and/or suspended sediment affect the acoustic signal strength.

2. Theory

Acoustic flowmeters were developed based on the principles that the transit time of an acoustic signal is longer in the upstream than downstream direction, and that these transit times can be accurately measured using microcomputer technology.

Discharge measurements are based on determining the average axial velocity in a full-flowing pipe. Knowing this velocity and the cross-sectional area of the measurement section, a discharge can be calculated. The difference in transit times of acoustic signals traveling in opposite directions through the water can be related to velocity of flow ([figure 11-1a](#)). In the downstream direction, the velocity of the flowing water, V_w , adds to the speed of sound, C , to give the effective speed of the acoustic pulse, $C + V_w$. In the upstream direction, the velocity of flow delays the arrival of the pulse, resulting in an effective pulse speed of $C - V_w$. Taking the difference in these transit times eliminates C from the calculations and results in Δt . When Δt is known, the average axial velocity can be obtained from the formula:

$$V_{axial} = \frac{L}{2\cos\theta} \left(\frac{1}{t_d} - \frac{1}{t_u} \right) = \left(V_{axial} = \frac{L}{2\cos\theta} \frac{\Delta t}{t_u t_d} \right) \quad (11-1)$$

where:

- V_{axial} = average axial velocity of waterflow
- t_u = upstream travel time of the acoustic signal
- t_d = downstream travel time of the acoustic signal
- Δt = difference in upstream and downstream travel times
- θ = angle between the acoustic path and the pipe's longitudinal axis
- L = acoustic path length between the transducer faces

Another acoustic flow measurement technique uses a similar approach which employs the frequency difference between upstream and downstream acoustic signals. This method is similar to the transit-time method and will not be covered. For more information, see American National Standards Institute/American Society of Mechanical Engineers (ANSI/ASME) standard MFC-5M-1985.

3. Available Technology

At this time (1996), many different types of acoustic flowmeters are available. As mentioned in previous sections, transit-time and frequency difference devices, as well as devices which use chordal (multipath) or diametral (single-path) paths to measure the average velocity in the pipe are available. Some systems use clamp-on transducers mounted to the outside of the pipe wall, and some use internal or wet-mount transducers. Likewise, some transducers are mounted in a spool, and others are installed in an existing section of pipe. All these options have their advantages and disadvantages, and they will be covered later.

All acoustic flowmeters consist of the following components.

(a) Primary Device

A spool piece with the transducers installed or an existing section of the pipe to which the transducers are mounted. Transducers can also be clamped to the outside of the pipe.

(b) Measurement Section

The pipe section in which the flow rate is being measured. This section is located between the upstream and downstream transducer locations and is usually a circular cross section, but acoustic flowmeters can be used in conduits of various shapes.

(c) Transducers

The transducers transmit and receive the acoustic signals. They may be factory or field mounted by clamping, threading, or gluing them to the pipe wall. Transducers can be wetted by the fluid or can be attached to the outside of the pipe. Wetted transducers may be flush mounted, protruding, or recessed. Some wetted transducers can be replaced without taking the pipeline out of service.

(d) Acoustic Paths

Single-path or multipath measurement sections can exist where each acoustic path consists of a pair of transducers. Common path configurations are diametral and chordal ([figure 11-1](#)) or diametrically reflective.

(e) Secondary Device

A secondary device contains the electronics necessary to operate the transducers, measure the transit times, process the data, and display and store the results. Most meters have several outputs available, including analog, digital, and/or alarms either as standard equipment or options. Likewise, several outputs can be stored or sent by telemetry to another location.

4. System Errors

Error sources for acoustic flowmeters are primarily related to the measurement of the average axial velocity. The main source of errors occurs in the determination of the acoustic path length, L , and the path angle, θ . The error in the velocity measurement is directly proportional to the uncertainty of these two variables. Care must be taken to minimize errors in measuring path length and angles. This care is especially necessary for chordal path meters because the computational procedures require accurate positioning of the acoustic paths. Likewise, errors in the cross-sectional area of the measurement section cause an error in the discharge measurement. This error can be a result of out-of-roundness or shape irregularities caused by temperature, pressure, structural loading, or deposits on the pipe walls. In circular pipe, cross-section dimensional errors can be reduced by averaging diameter measurements made at upstream, midsection, and downstream ends of the measurement section.

Another source of error occurs in measuring the transit times of the acoustic signals and in detecting the acoustic signal in the presence of electrical noise.

Signal detection can also be hindered by signal modifications caused by changes in acoustical properties of the liquid which are caused by entrained air, suspended solids, and changes in temperature and pressure. Likewise, transducer fouling by algae or mineral deposits can reduce signal strength.

Secondary flows can create an error in the determination of V_{axial} because the calculations are based on flow direction in the axial direction only. Secondary flow is caused by flow disturbances near the measurement section. These disturbances are typically caused by valves, elbows, or transitions. Secondary flow problems can be avoided by careful selection of the measurement section. For small pipes (diameters less than 36 in), 10 pipe diameters of straight pipe upstream and 3 to 5 diameters downstream from the measurement section should be sufficient. For pipe diameters greater than 36 in, 20 to 30 pipe diameters of straight pipe upstream and 3 to 5 diameters downstream may be required to obtain an acceptable velocity profile. If the measurement section must be placed near a bend, secondary flow errors can be reduced by orienting the acoustic paths perpendicular to the plane of the bend and locating the transducer as far downstream as possible. Likewise, another solution is the addition of another acoustic path which crosses the first path. Exact cancellations of secondary flow errors can be accomplished using a cross path configuration. The diametrically reflective path provides a cross path directly. Other variations in velocity profiles, due to Reynolds number effects and pipe wall roughness, can be corrected using a velocity profile correction factor. This correction factor corrects for the difference between the actual velocity profile and the profile assumed in the flowmeter's calculations. In general, deviations in velocity profiles are best accounted for by increasing the number of acoustic paths.

5. Installation Considerations

Many of the errors considered above can be eliminated or decreased by following the manufacturer's installation guidelines. Errors and their sources should be addressed prior to flowmeter installation. The following paragraphs cover areas which should be examined. More detailed descriptions are available in American Society for Testing and Materials (1984), American National Standards Institute (1985), and Laenen (1985).

(a) Acoustic Path Length and Angle

Changes in acoustic path length and angle can be caused by significant changes in pressure or temperature, along with external loading on the meter section. The measurement section should be examined to determine if any of these conditions exist. In addition, path lengths and angles must be known with a high degree of accuracy.

(b) Signal Detection

Entrained air, suspended solids, and transducer fouling may lower accuracy or prevent operation by weakening the acoustic signal. Electrical and acoustical noise caused by mechanical vibration, other electrical devices, or cavitation can also disrupt the flowmeter's operation.

(c) Secondary Flows

Secondary flow or crossflow affects a meter's performance and should be evaluated in the system design. This design evaluation should include selecting a diametral path or chordal path meter and deciding whether a second crosspath is necessary. Path orientation should also be considered. Typically, the measurement section should be located as far downstream as practical from upstream bends, transitions, valves, and pumps.

(d) Velocity Profile Integration

Chordal-path meters use numerical integration techniques to compute the flow rate. It is important that the chordal paths are positioned in accordance with the particular locations specified by the manufacturer.

(e) Calibration

In general, acoustic flowmeters do not require a field calibration when manufacturer's suggested installation criteria have been met or exceeded. However, in some cases, unusual installation conditions or the need for a high degree of accuracy may require a calibration. Three methods exist for flowmeter calibration: (1) laboratory calibration, (2) field calibration, and (3) analytical techniques. For more information on calibration techniques, a good reference is the ANSI/ASME standard MFC-5M-1985 (American National Standards Institute, 1985).

6. Flowmeter Selection Guidelines

(a) Single-Path Versus Multi-Path Flowmeters

Single-path meters are generally a lower cost alternative. They are also less complex which allows easier installation. Multi-path meters perform better under variable and/or non-ideal velocity profile distribution situations caused by upstream and downstream flow disturbances. Acoustic path orientation varies among meters; paths can be either crossed or parallel, or either chordal or diametral. The appropriate path configuration depends on site-specific constraints, economics, and the application.

(b) External Mount Versus Through-Wall Transducers

External mount transducers are the easiest to install and require minimal surface preparation. As a result, installation is inexpensive when compared to through-wall transducers. External mounting transducers are non-intrusive, so they do not disturb the flow. They are also easily removed and replaced without taking the pipe out of service. It should be noted that errors in flow measurement caused by variable or changing wall and/or liner thickness can be significant.

Through-wall transducers are usually wetted or covered with a protective material. This type of transducer mount may provide increased acoustic signal strength because no signal attenuation occurs through the pipe wall. Through-wall transducers can be flush mounted, protruding, or recessed. Protruding or recessed transducer mounts can cause a local flow disturbance which may affect the flowmeter accuracy. Errors caused by a protruding or recessed transducer or the protective covering require a detailed analysis of the installation configuration.

The potential for transducer fouling from various waterborne contaminants (algae, minerals, etc.) also exists.

Theoretical equations used for acoustic flow measurement are based on the assumption that the transducers are in direct contact with the fluid. A protective covering or an external mount transducer will change the transit times and path angles. These changes are usually mathematically modeled by the manufacturer and corrected for by the secondary device.

7. Open Channel Acoustic Flowmeters

Open channel acoustic flowmeters are based on the same principles as pipeline flowmeters. However, open channel acoustic flowmeters are more complicated than pipeline flowmeters because the cross-sectional area varies with changing water level or stage. In general, these flowmeters are only economically practical for use where the following conditions exist:

- Channel widths are large.
- Head loss must be minimized.
- High accuracy is required.
- Section rating and stream gaging costs are high.
- Bidirectional flow (tidal) must be measured.
- Continuous measurements over a long time period are required.

This section will cover any additional considerations associated with open channel acoustic flowmeters not covered in the previous section on closed conduit acoustic flowmeters. Laenen (1985) and Laenen and Curtis (1989) contain more detailed information on open channel acoustic flowmeters.

Design of open channel meters is complicated by the potential errors introduced by a variable water surface and because the open channel environment can cause acoustic signal attenuation and refraction (bending). Another potential problem is signal deflection caused by density gradients or signal reflection from the channel bottom or water surface.

(a) Single-Path Acoustic Velocity Meters

In general, single-path acoustic velocity meters (AVMs) are used as flowmeters by calibrating acoustic path velocities against mean channel velocities computed using standard stream gaging techniques. The discharge rating procedure for an AVM gaging site will involve developing ratings for both cross-sectional area and mean channel velocity. Necessary data required to develop these ratings are a stage-area relationship, acoustic path velocities, and the mean velocities through the discharge measurement cross section for a range of flows and stages. A data set should uniformly cover the expected range of stage and discharge. A velocity rating is developed using linear regression techniques to find the best-fit equation, with the instantaneous mean channel velocity as the dependent variable, and/or stage (acoustic path velocity) as the independent variables. After a calibration is established, discharge is computed by multiplying the instantaneous mean channel velocity, predicted from the best-fit equation, and the channel's cross-sectional area, which is determined using the stage-area rating. This method of flow measurement is only as accurate as the ratings developed during the calibration.

Therefore, care must be taken while measuring the discharge and in determining the channel's cross-sectional area for a range of stages. For installations where appreciable changes in stage occur, the transducers will have to be positioned to allow a full range of measurements.

(b) Multipath Flowmeter

This type of flowmeter uses several acoustic paths which are mounted at various elevations throughout the measurement section. The average velocity for each path is used to establish the velocity profile. The velocity profile is then numerically integrated over the channel's cross-sectional area to determine the volumetric flow rate. As a result, flowmeter accuracy is relatively independent of the velocity profile. However, integration errors are unavoidable because the velocities near the channel bottom and water surface cannot be measured because of acoustic interference caused by signal reflection.

(c) Limitations

Flowmeter accuracy and performance are limited by four factors:

1. Location of acoustic paths with respect to water surface and the channel bottom, which are reflective surfaces that can cause multipath interference at the receiving transducer(s).
2. Density gradients (usually caused by different water temperatures or salinities) cause the acoustic path to bend, which changes the acoustic path length.
3. Acoustic signal attenuation caused by varying concentrations of air bubbles, sediment, organic matter, and aquatic organisms.
4. Streamflow variability, which causes the angle between the acoustic path and the flow to change.

(d) Availability

Two types of equipment are available for use in measuring velocity: (1) a simple one- or two-path microprocessor based, preprogrammed system that will measure velocity only, and (2) a more complex, programmable, multipath minicomputer that can calculate discharge. At present (1997), open channel systems use 12 volts direct current or 110/220 volts alternating current.

(e) Site Selection

A thorough review of system limitations and equipment requirements is necessary prior to site selection (Laenen, 1985; Laenen and Curtis, 1989). A good measurement site has a reach where the velocity distribution is uniform and the channel is confined; areas with eddies or a high degree of turbulence should be avoided. It is recommended that the channel be relatively straight for 5 to 10 channel widths upstream and 1 to 2 channel widths downstream from the measurement section. The channel bottom should be stable or easily monitored for variations. A constant cross-sectional area and shape over the upstream and downstream extent of the measurement section is desirable.

If this condition cannot be met, an "effective" cross-section shape must be determined. The "effective" cross section is determined by taking the cross-sectional area along the acoustic path multiplied by the cosine of the path angle, θ .

A concrete-lined section with a straight reach located upstream is ideal. During site selection, obtain cross-section survey information and note obstructions which may block the acoustic signal. Obtain temperature, total dissolved solids and sediment concentrations, and possible sources of air entrainment (overfalls, spillways, etc.). Variations in stage should be known in order to determine the number of acoustic paths required to assure the system accuracy.

(f) Transducer Mounting Requirements

When transducers are installed, their position and elevation must be measured and adjusted accurately for each transducer pair. Likewise, path lengths and path angles must be measured accurately. Transducer alignment is critical for establishing a strong acoustic signal and is usually performed by divers. Mountings should be designed so that transducer maintenance can be performed without using divers. Transducers are normally mounted near the banks, so mounting transducers on existing structures simplifies the installation process. Cabling options include submarine, overhead, or a responder link which eliminates the need for a cable crossing the channel. Cabling must be protected from damage from dredging, marine traffic, or vandalism.

(g) Site Analysis

The acoustic path(s) at each site should be checked for multipath interference caused by the water surface or channel bottom. In general, for every 100 feet (ft) of acoustic path length, about 1 ft of clearance is necessary to prevent multipath interference. The transducers should be located at least 20 in below the water surface to prevent signal bending caused by solar warming. Signal bending will affect the flowmeter accuracy. Therefore, avoid conditions where the acoustic signal is bent and is reflected off the water surface and/or channel bottom. Check the acoustic signal for potential attenuation. The normal sediment concentration that can be tolerated by most systems is about 2,000 milligrams per liter. However, tolerable concentrations are a function of transducer frequency, particle size, and acoustic path length.

(h) Calibration

Flowmeter calibration can be done using current meter measurements, other velocity-area methods, or using computations based on theoretical velocity profiles. The effort expended for calibration will depend upon factors such as number of acoustic paths, flow conditions at all stages, channel stability, and accuracy requirements. However, accuracy can be verified only within the limits of the calibration method used.

(i) Accuracy

For many streamflow conditions, a single-path flowmeter can measure flow within an accuracy of 3 to 5 percent. For multipath systems, accuracies of 2 percent or better can be achieved over a wide range of flow rates and channel conditions if the system design addresses the major sources of errors of acoustic flow measurement. Errors associated with open channel acoustic flowmeters are usually attributed to three sources:

1. Transit-time measurements, where timing errors can be on the order of 0.1 foot per second (ft/s) for systems which employ signal validation routines or 0.3 ft/s when signal validation techniques are not used.
2. Acoustic path angle variation. In general, for every one degree of uncertainty in path angle, about 1 percent uncertainty occurs in velocity measurement. Use of crossed acoustic paths will compensate for variations in streamflow direction.
3. Acoustic signal bending. For path lengths less than 1,000 ft, this error is usually less than 3 percent in velocity.

(j) Operation and Maintenance

Acoustic flowmeters are advanced electronic systems that require specialized maintenance. Properly trained technicians are needed to keep the flowmeter operating. An electronic technician and proper test equipment are needed to troubleshoot the equipment. This requirement is especially true during the initial phases of installation. Likewise, transducer mounts should be designed to allow access for transducer cleaning, alignment, and replacement without using divers.

8. Doppler-Type Acoustic Flowmeter

The Doppler flowmeter measures the velocity of particles moving with the flowing fluid (figure 11-2a). Acoustic signals of known frequency are transmitted, reflected from particles, and are picked up by a receiver. The received signals are analyzed for frequency shifts (changes), and the resulting mean value of the frequency shifts can be directly related to the mean velocity of the particles moving with the fluid. System electronics are used to reject stray signals and correct for frequency changes caused by the pipe wall or transducer protective material. Doppler flowmeter performance is highly dependent on physical properties such as the liquid's sonic conductivity, particle density, and flow profile. Likewise, non-uniformity of particle distribution in the pipe cross section results in a computed mean velocity that is incorrectly weighted. Therefore, the meter accuracy is sensitive to velocity profile variations and to distribution of acoustic reflectors in the measurement section. Unlike other acoustic flowmeters, Doppler meters are affected by changes in the liquid's sonic velocity. As a result, the meter is sensitive to changes in density and temperature. These problems make Doppler flowmeters unsuitable for highly accurate measurements.

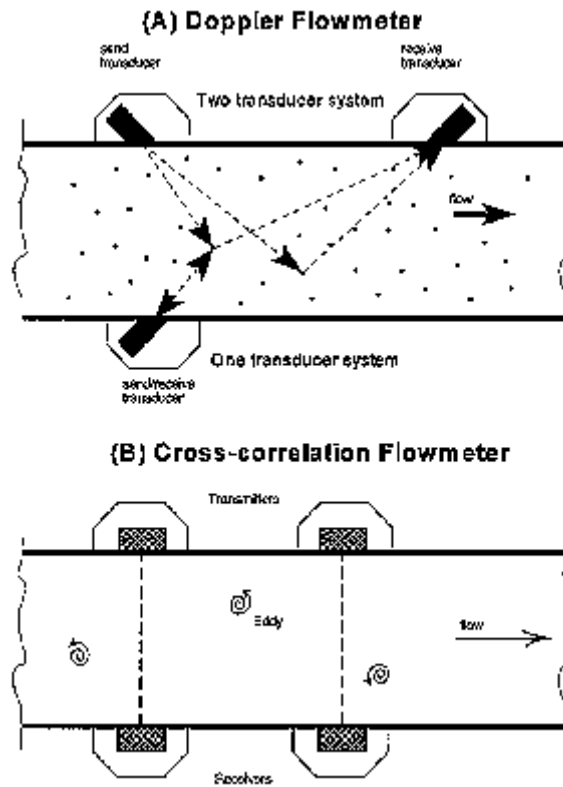


Figure 11-2 -- Doppler-type acoustic flowmeter and cross-correlation acoustic flowmeter.

9. Cross-Correlation Ultrasonic Meter

The cross-correlation meter employs two transverse acoustic signals separated by a short distance ([figure 11-2b](#)). Under no-flow or laminar-flow conditions, the two signals received are identical to those transmitted. When turbulent flow occurs, the movement of an eddy through a beam causes a change in the acoustic signal which has a unique signature. This particular eddy will cause an identical change in the second acoustic signal, and the eddy can be tracked as it moves down-stream. An electronic signal processor is used to compare the two received signals. When two identical signals are found, the time and distance (between the acoustic transmitters) information is used to compute velocity. In general, cross-correlation meters measure the average velocity of all the eddies crossing one pipe diameter. If no eddies are present in the flow, the meter can track sediment or bubbles. However, if the flowing fluid is homogenous and has no eddies (laminar flow), this type of meter will not work. Like the single-path transit-time meter, this meter measures an incorrectly weighted mean velocity. Therefore, the measurement is susceptible to an inaccuracy associated with variations in velocity profiles.

Additional information for *Acoustic Flow Measurement*

The listings here should not be construed as an endorsement or recommendation of a service or product by the Bureau of Reclamation, Agricultural Research Service, Natural Resource Conservation Service, or other participants of these web pages. These are provided only as a convenience to our web clients. The listing below were selected based on a manufacture statement that they can provide a device related to this chapter or section.

Web Resources

The ADFM Velocity Profiler™ - A Report on Laboratory and Field Demonstrations Conducted for the Bureau of Reclamation

Mike Metcalf - MGD Technologies Inc.; Tracy Vermeyen - Bureau of Reclamation, Water Resources Research Laboratory; Steve Melavic, John Fields - Bureau of Reclamation, Mid-Pacific Region
Mike Metcalf - MGD Technologies Inc.; Tracy Vermeyen - Bureau of Reclamation, Water Resources Research Laboratory; Steve Melavic, John Fields - Bureau of Reclamation, Mid-Pacific Region

Introduction

A new type of flowmeter, the ADFM Velocity Profiler™ (Profiler) was demonstrated on March 3 and 4, 1997 at the Bureau of Reclamation's Water Resources Research Laboratory in Denver, Colorado. The demonstration was organized by Tracy Vermeyen of the Bureau of Reclamation and Mike Metcalf of MGD Technologies, the manufacturer of the Profiler. A subsequent field test of the instrument was conducted in the San Luis Drain near Los Banos, CA, on March 14, 1997. John Fields and Steve Melavic of the Bureau of Reclamation's Mid-Pacific Regional Office were responsible for organizing this test. This report documents the results of these tests.

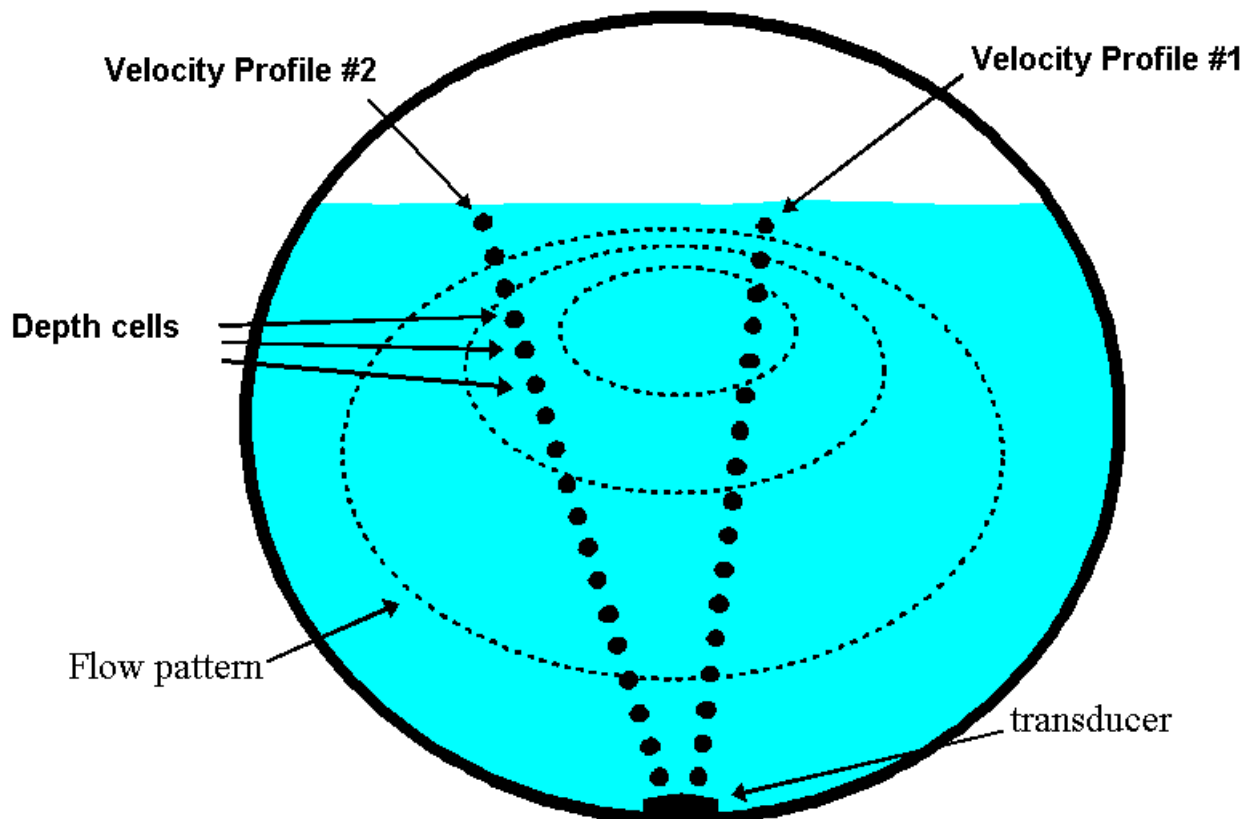


Figure 1. Cross section view of typical Profiler application. This figure shows the spatial relationship of the depth cells and the profiles relative to the transducer housing.

The Instrument

Figure 1 shows a typical Profiler installation for measuring open channel flow in a pipe. A transducer assembly is mounted on the invert of a pipe or channel. Piezoelectric ceramics emit short pulses along narrow acoustic beams pointing in different directions. Echoes of these pulses are backscattered from material suspended in the flow. As this material has motion relative to the transducer, the echoes are Doppler shifted in frequency. Measurement of this frequency shift enables the calculation of the flow speed. A fifth transducer is mounted in the center of the transducer assembly and is used to measure the depth.

The Profiler divides the return signal into discrete regular intervals which correspond to different depths in the flow. Velocity is calculated from the frequency shift measured in each interval. The result is a profile, or linear distribution of velocities, along the direction of the beam. Each of the small black circles in Figure 1 represent an individual velocity measurement in a small volume known as a depth cell.

The directions of the velocity profiles in Figure 1 are based on the geometry of the Profiler's transducer assembly. Figure 2 shows a side view of the transducer assembly. The profiles shown in Figure 1 are generated from velocity data measured by an upstream and downstream beam pair. The data from one beam pair are averaged to generate Profile No. 1, and a beam pair on the opposite side of the transducer assembly generates Profile No. 2.

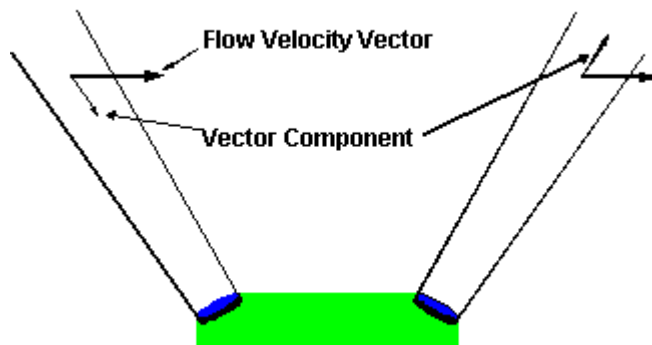


Figure 2. Side view of the Profiler transducer assembly and its beam geometry.

Since Doppler measurements are directional, only the component of velocity along the direction of the transmit and receive signal is measured, as illustrated in Figure 2. Narrow acoustic beams are required to accurately determine the horizontal velocity from the measured component. The narrow acoustic beams of the Profiler insure that this measurement is accurate. Also, the range-gate times are short and the depth cells occupy a small volume - cylinders approximately 5 cm (2 in.) long and 5 centimeters in diameter. These small sample volumes insure that the velocity

measurements are truly representative of that portion of the flow and potential bias in the return energy spectrum due to range dependent variables is avoided. The result is a very precise measurement of the vertical and transverse distribution of flow velocities.

The velocity data from the two profiles are entered into an algorithm to determine a mathematical description of the flow velocities throughout the entire cross-section of the flow. The algorithm fits the velocity data to the basis functions of a parametric model. The parametric model is used to predict flow velocities at points throughout the flow. The resulting velocity distribution is integrated over the cross-sectional area to determine the discharge.

The key benefit to this approach is that the system will operate accurately under variable hydraulic conditions. As hydraulic conditions change, the change will manifest itself in the distribution of velocity throughout the depth of flow. As the Profiler is measuring the velocity distribution directly, it can adapt to changes in the hydraulics, and generate a flow pattern that is representative of the new hydraulic conditions, insuring an accurate estimate of flow rate.

Test Procedure

The Profiler was first tested in two sites at the Bureau of Reclamation's Water Resources Research Laboratory in Denver: a 4-ft-wide flume, and a 12-ft-wide rectangular channel. In both lab sites, the system was installed on the bottom of the flume, centered with the transducer's long axis aligned with the flume's axis (flow direction). No in-situ calibration or rating was performed.

4 ft flume tests - The test began with a flow depth of approximately 4 ft. The depth was increased after about one hour to around 7 ft. Profiler flow measurements were then compared with the venturi meter flows to check for accuracy and repeatability.

12 ft channel tests - The test began with a depth of flow of approximately 2 ft. The depth was decreased after about one hour to about 1.2 ft. Profiler flow measurements were then compared with the venturi meter flows to check for accuracy and repeatability.

The venturi meter flows were determined using a mercury manometer to measure the pressure differential across the venturi. This manometer was manually read several times during the tests. Once set up, the flow was held constant as it was controlled by an active feedback control system. The laboratory venturi meter was calibrated prior to the Profiler demonstration. A weigh tank facility was used to calibrate the venturi meter and the uncertainty in the venturi meter measurement was within ± 0.8 percent of the weigh tank flow rate.

Following the laboratory tests, the Profiler was placed in a "live" channel - the San Luis Drain located near Los Banos, CA. This channel is an irrigation drain for part of the San Joaquin Valley. The channel is trapezoidal in shape, with an 8 ft bottom width and 2:1 side slopes.

The Profiler was placed on an aluminum strap about 44 ft in length. Hinges were placed on the strap so that the 8 ft. center piece would lay flat on the channel bottom and the rest of the strap would conform to the side slopes of the channel. The channel was in normal operation during the installation with a flow depth of approximately 7.2 ft.

Results

Figure 3 shows the results from the 4 ft flume tests. The round symbols represent the Profiler data and the square symbols are the spot readings from the venturi meter. As shown in figure 3, the Profiler data agrees very well with the venturi meter readings.

At the beginning of the data record there is some scatter to the Profiler data, as the flow into the flume had just been set and the depth in the flume was still equilibrating. After the first few points, the flow rate readings and depth readings become steady. The Profiler measured an average flow rate of $6.86 \text{ ft}^3/\text{s}$ during the initial depth of flow of 4 ft (after depth equilibration), compared to $6.98 \text{ ft}^3/\text{s}$ for the venturi readings during the same time period; a difference of -1.72%. We also see a change in the Profiler flow rate measurement after the level was increased to 7 ft at around 10:00 a.m. The Profiler over predicts the flow because one pair of acoustic beams intersects the walls of the flume. Consequently, the average velocity is skewed higher because it is measured near the middle of the flume where velocities are larger than near the wall.

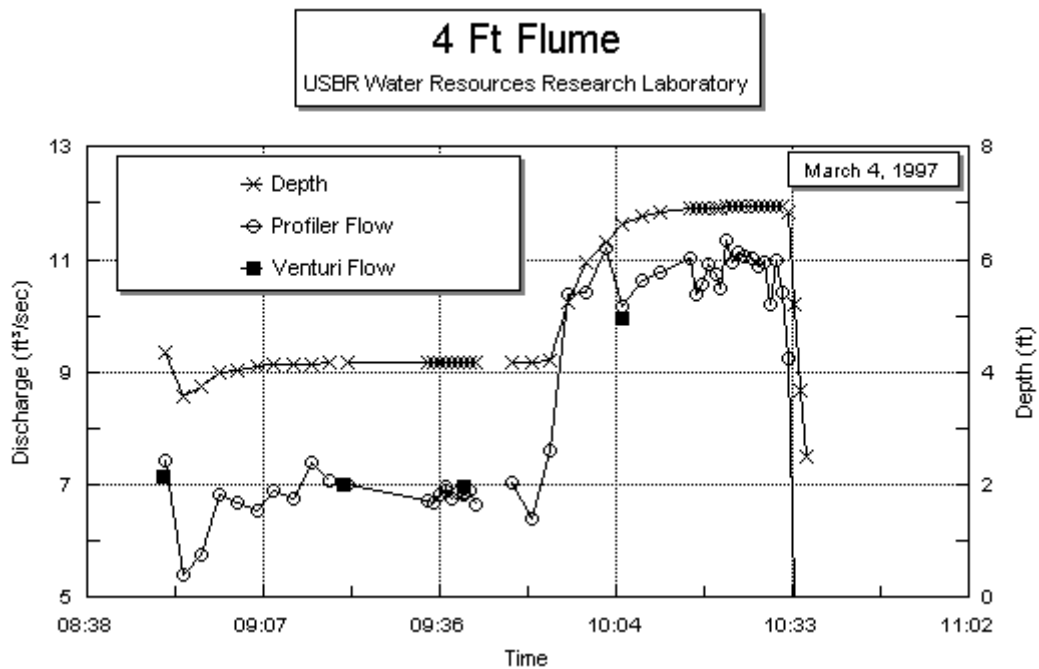


Figure 3. Profiler and venturi flow rates measured in the 4 ft flume are plotted as a function of time. The Profiler's depth reading is also plotted to illustrate the effect of fluctuating water surface level on the discharge measurement accuracy.

The spacing on the x-axis is irregular because several sampling schemes, in which parameters such as bin size and sampling interval, were varied. In most cases, changing these parameters did not affect the overall accuracy of the flow rate measurement.

Figure 4 shows the results from the 12 ft channel test. The round symbols are the Profiler data and the square symbols are the spot readings from the venturi meter. For this test, the Profiler data were averaged over a variety of time periods. Whereas Figure 3 is a plot of "raw" flow data, where each point corresponds to a individual measurement separated by an interval varying from one to five minutes. The first seven ADFM measurements were collected with an one minute averaging interval. The average of these seven measurements is 10.48 ft³/sec. The venturi meter reading was 10.26 ft³/sec, and this flow remained constant for the remainder of the test. The next five ADFM measurements were collected with an averaging interval of 5 minutes. The average of these five measurements is 10.29 ft³/sec. The next six ADFM measurements were collected with an averaging interval of 2 minutes. The average of these seven measurements is 10.43 ft³/sec. This test demonstrates how Profiler measurements becomes more precise as the number of measurements averaged together were increased. The ability to average hundreds of flow measurements over a short period results in a very precise flow measurement. This is illustrated by comparing the average of the all eighteen Profiler measurements with the two venturi meter readings. The Profiler average was +0.97% different from the venturi meter average. The last ADFM measurement was collected with an averaging interval of 2 minutes at a depth of 1.2 ft. The measured flow rate was 10.0 ft³/sec. This measurement was made with a 10:1 width to depth ratio. This demonstrates the Profiler's unique capability to measure flows in wide, shallow channels.

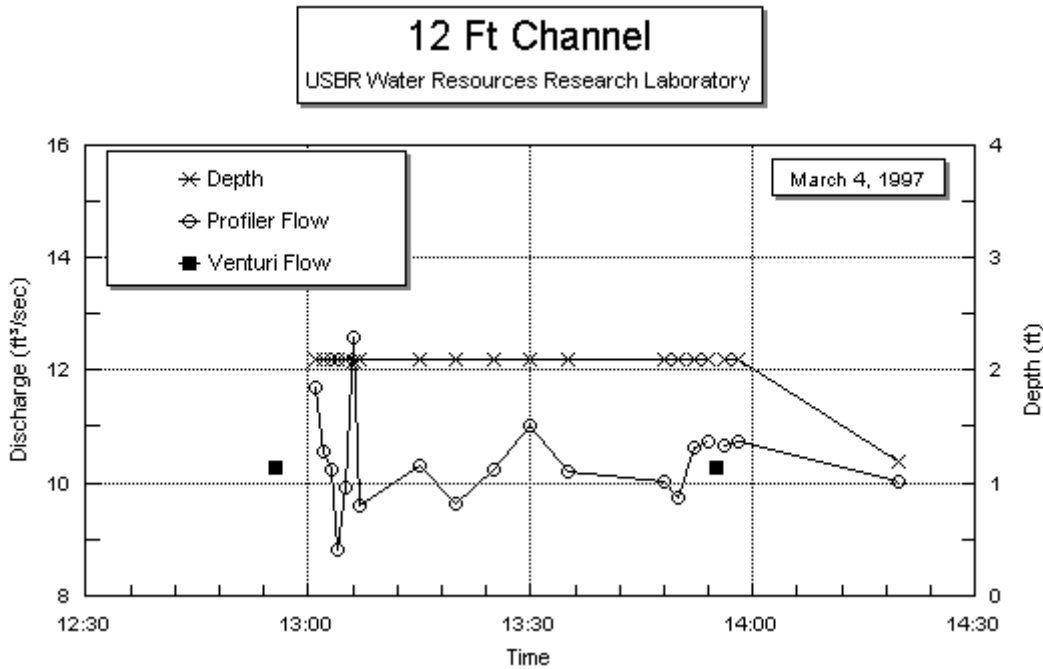


Figure 4. Profiler and venturi flow rates measured in the 12 ft channel are plotted as a function of time. The Profiler's depth reading is also plotted. Initially the Profiler's discharge measurements were variable, but with time the accuracy improved to within 1 percent of the venturi-measured discharge.

Figure 5 contains a plot of the flow rate, depth, and average velocity measured in the San Luis Drain near Los Banos, CA on March 14, 1997. All three measured parameters were steady over the test period. Variations in the flow rate correlate with variations in the average velocity, as the depth remains fairly constant. The average flow rate over the duration of the test was 91.1 ft³/s. Flow rates of approximately 80 and 86 ft³/s were measured using traditional stream gaging methods. Stream gaging velocities were measured with a Marsh-McBirney Flo-Mate, which is an electromagnetic velocity meter.

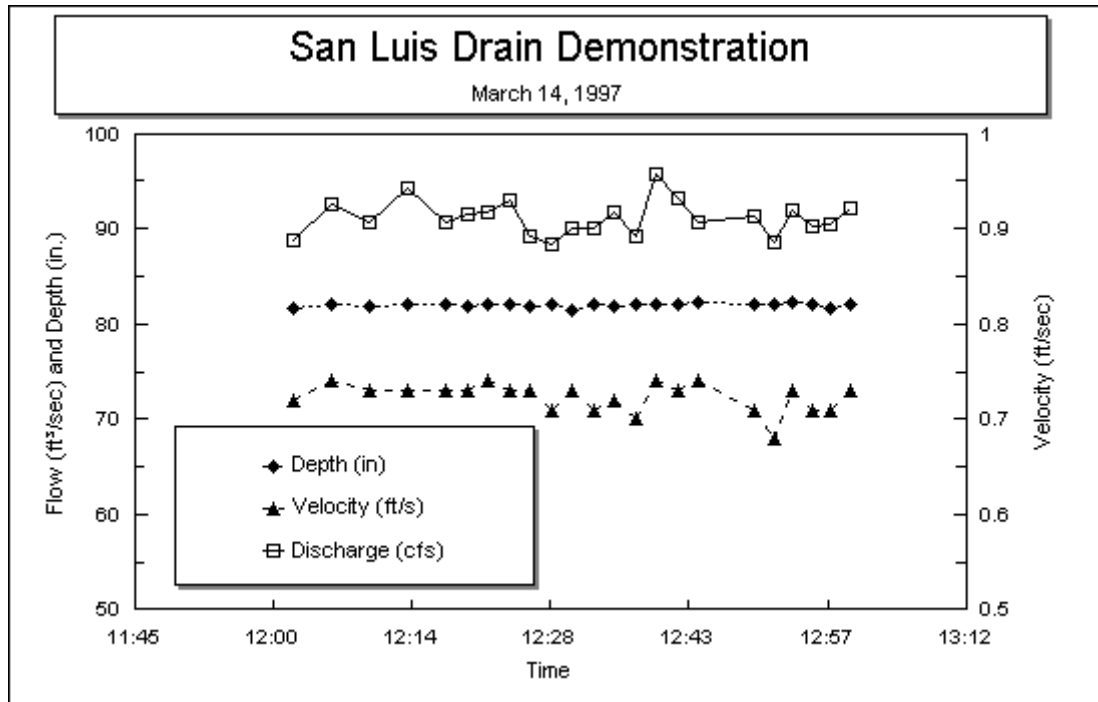


Figure 5. Flow rate, depth, and average velocity plotted as a function of time. The average flow rate measured in the San Luis Drain was 91.1 cfs with a standard deviation of 2.0 percent.

The first discharge measurement was obtained by manually measuring velocities at 0.2 and 0.8 of the depth measured from the water surface, at regular intervals across the channel. These velocities were used to compute an average velocity for a particular section of the channel. Multiplying this average velocity by the cross-sectional area of the individual section gives a flow rate for that section. The section flow rates are summed to determine the total flow rate for the channel.

The second discharge measurement was obtained by making a single velocity measurement at a height above the bottom of 0.6 of full depth, at regular intervals across the channel. This value was used as the average velocity in that section to compute a flow rate for that section. Again, section flow rates are summed to determine the total flow rate in the channel.

Note: This velocity measurement should have been measured at 0.6 of the depth measured from the *surface* not the bottom.

It should be mentioned that there was some concern over the accuracy of the manual velocity measurements. The relationship between the velocities measured at the various depths was not as expected. In particular, the velocity value measured at a height above the bottom of 0.8 of full depth, in some cases, was lower than anticipated.

Conclusions

- For laboratory tests, the Profiler measured flow rate with an accuracy of approximately 1.7% in the 4 ft. flume and 1.0% in the 12 ft. channel. The Profiler was able to accurately measure flow rate even with a width to depth aspect ratio of 10:1.
- This test demonstrated that the Profiler does not require an in situ calibration or rating Profiler to make an accurate flow measurement. Accurate flow measurements were attained without any special consideration to the installation, aside from placing the Profiler in the middle of the flow and aligning it with the direction of flow.
- The Profiler was successfully installed in a "live" channel, without interrupting the flow. Flow rates measured were repeatable and within roughly 10% of a traditional stream gaging measurement. However, there was some concern that the stream gaging measurement might not be accurate, as some velocities appeared lower than anticipated. This would lower the flow rate estimate generated by the stream gaging method.
- This demonstration was useful in showing the ability of the ADFM Velocity Profiler to measure flow rates in a variety of conditions with a minimal amount of time required to install and setup the instrument. This new technology has the potential to provide flow measurement in areas where traditional discharge measurement devices are impractical. It also could be a valuable tool for calibrations of existing flow measurement structures and for research studies that require velocity profile measurements.
- This instrument can accurately measure detailed velocity profiles in an open channel which can be used for engineering studies. For example, the ADFM can be used to measure velocity profiles which describe flow into and around structures such as fish screens or fish ladders.

Related links

[MGD Technologies Inc.](#) is a professional firm specializing in the assessment of the condition and performance of underground utility systems. The services are provided by highly trained individuals, experienced in the innovative application of integrated, advanced technologies.

[MGD's ADFM](#) measures the flow velocity at discrete points throughout the depth of flow.

MGD Technologies Inc.

9815 Carroll Canyon Road, Suite 200

San Diego CA 92131 USA

Tel. 619 695 9225

Fax 619 695 6890

10. Bibliography

American Society for Testing and Materials, *Open Channel Flow Measurement by Acoustic Means*, Standard Practice D 4408-84, 1916 Race Street, Philadelphia PA 19103, 1984.

American National Standards Institute, *Measurement of Liquid Flow in Closed Conduits Using Transit-Time Ultrasonic Flowmeters*, ANSI/ASME MFC-5M-1985, ASME United Engineering Center, 345 East 47th Street New York NY 10017, 1985.

Laenen, Antonius, *Acoustic Velocity Meter Systems*, U.S. Geological Survey Techniques of Water Resources Investigations, book 3, chapter A17, U.S. Geological Survey, 1985.

Laenen, A., and R.E. Curtis, Jr., *Accuracy of Acoustic Velocity Metering Systems for Measurement of Low Velocity in Open Channels*, U.S. Geological Survey, Water Resources Investigations Report 89-4090, 1989.

CHAPTER 12 - DISCHARGE MEASUREMENTS USING TRACERS

1. General

Tracer methods can be used to determine discharge with accuracies that can vary considerably from about +/-1 percent to over 30 percent, depending on the equipment used and the care in applying the techniques. Closed conduit measurements are typically more accurate than open channel measurements because of better area measurements, better tracer dispersion and mixing control, and better measurement of tracer cloud travel times. However, injection of tracers against pressure in pipelines can be a challenge. Finding sufficient length of pipeline above ground for accurate time measurement may be difficult due to high velocities and pipeline fittings. In contrast, mixing can be a problem at low velocities, which often happens in open channels. Tracer methods are included in the American Society of Mechanical Engineers *Performance Test Codes* (1992) because of their high accuracy potential.

2. Kinds of Tracers Used

Basically, a tracer is considered anything that mixes with or travels with the flow and is detectable. A detectable tracer can be timed as it passes through a reach, or tracer concentration profiles can be measured in a reach.

Some tracers that have been used are:

- Dyes of various colors
- Other chemicals such as fertilizer, salt, and gases
- Radioisotopes
- Heat
- Traveling turbulent eddy pressure sequences
- Neutrally buoyant beads
- Floats

For irrigation measurements, salts and dyes are the most convenient and commonly used tracers. Salt tracers are sensed and quantified by measuring evaporated dry weight, chemical titration, or by measuring electrical conductivity. Dye concentrations are measured by fluorimetry or color comparison standards. Sometimes, visual observation of an exiting dye cloud is used, but considerable loss of accuracy occurs.

Fluorescein, Rhodamine B, Rhodamine WT, or Pontacyl Pink B dyes have been used because they are easily visible in very dilute solutions. Rhodamine B and Rhodamine WT have been cleared as nontoxic by the U.S. Food and Drug Administration. Rhodamine and Pontacyl Pink B are also quite stable with respect to fading by sunlight and to changes caused by waterborne chemicals. They do not tend to deposit on flow surfaces, sediments, or weeds. These dyes are usually available in powder form, and solutions are easily prepared. Before conducting a discharge measurement program, selected dyes should be tested with water samples or earth canal embankment material samples and exposed to check for possible adsorption, chemical reaction, and fading effects on dye stability.

Less frequently used methods involve measuring temperature upstream and downstream from a heat source and electronic cross correlations of trains of turbulent pulsations using acoustic methods discussed in chapter 11. The use of surface floats is discussed in chapter 13. Neutrally buoyant beads are usually used in laboratory work to track flow. Mixtures of beads with different specific gravities can also detect and measure fluid density profiles and stratification.

Radioisotopes are now rarely used because of their safety and pollution risks. In addition, isotope handlers must be licensed. However, use of any chemical or anything that can affect ecological characteristics of the water or conveyance boundaries may require clearance from several Federal and State authorities such as the U.S. Food and Drug Administration, the U.S. Environmental Protection Agency, and State fish and wildlife and natural resource departments. Government regulations and limits change with time and should be checked prior to a measurement program. However, even when operating within government regulations, public complaints related to taste and color and particles in the resulting water may occur.

3. General Methods of Application

Salt and dye tracers are used to determine discharge in two basic ways: (1) the velocity-area method, in which time of tracer travel through a known channel length and average cross-sectional area determine discharge and (2) the dilution method, in which discharge is determined by the downstream concentration of fully mixed tracer, which has been added upstream at a constant rate, and by accounting for the amount of tracer solids.

4. Discharge Equations for Tracer Methods

The following equations apply to both open channel and closed conduit flow.

(a) Velocity-Area Tracer Discharge Equation

The discharge using velocity-area method is computed by:

where:

$$Q = \frac{AL}{T} \quad (12-1)$$

Q = discharge in cubic feet per second (ft³/s)

A = average cross-sectional area of reach length in square feet (ft²)

L = reach length between detection stations in feet (ft)

T = recorded time required for the tracer solution to travel between the detection stations at each end of the measurement reach in seconds (s)

(b) Tracer-Dilution Discharge Equation

The dilution method equation for discharge is:

$$QC_0 + qC_1 = (Q + q)(C_2) \quad (12-2a)$$

Solving for discharge in equation 12-2a results in:

$$Q = q \frac{C_1 - C_2}{C_2 - C_0} \quad (12-2b)$$

where:

C_0 = the natural or background concentration of the tracer of the flow

C_1 = the concentration of the strong injected tracer solution

C_2 = the concentration of tracer after full mixing at the sampling station, including the background concentration of the stream

Q = the discharge being measured

q = the discharge of the strong solution injected into the flow

Equation 12-2 can be modified for use in terms of weight by substituting percent of dry weight of tracer for concentrations and weight of water per second for discharges.

The discharge of the channel flow, Q , is measured by determining C_0 , C_1 , C_2 , and the injection rate, q . These required variables and equation 12-2 show that the dilution method does not need measurement of channel geometry or time measurement. Only the final plateau value or C_2 , the downstream concentration, must be recorded rather than a complete record of the passing cloud that is needed with the salt-velocity-area method.

5. Common Sources of Errors

Tracers should be quite stable as previously mentioned. They should not deposit or react with chemicals in the water or with the pipe walls and their encrustations. Selected tracers should neither fade in sunlight nor be absorbed by open channel beds and their biological growths. These losses of tracer are a common source of discharge measurement error. In open channels, large backflow eddies can delay the dye and impede mixing. It is best to select a reach where large eddies or stagnant pools cannot significantly delay the tracers or affect mixing. The concentration of tracer solutions should be determined relative to needed visual observation or equipment detection sensitivity by careful analysis and verified by trial runs before a program of discharge measurements is undertaken.

Accuracy is also sensitive to how well the center of mass of the tracer clouds is determined with respect to time. First and last visual observations of a tracer cloud are difficult, and the mass center may not be located in the time center of the cloud.

With elaborate equipment such as multi-port pop valves, turbulators (turbulence-creating devices), complex electrodes, and fluorometers, accuracy can approach +/-1 percent. This degree of accuracy requires using the procedures included in American Society of Mechanical Engineers *Performance Test Codes* (1992).

For irrigation water, the strict code procedures, quality of procedures, equipment, and instrumentation can be relaxed to produce lower levels of accuracy. The selected accuracy target governs the complexity of needed injection equipment, detection equipment, and the quality of recorded data analysis.

The least accurate method would involve breaking a bottle of dye contained in wire mesh at an upstream station of a long reach at time zero and visually observing and estimating the time that the center of mass of the dye cloud passes the exit. Any simplified procedure must be evaluated for effect on mixing. Prior to a measurement program, equations 12-1 and 12-2 should be used for error analyses in terms of proposed equipment and procedures because they affect the equation variables. These analyses will determine if the simplified measurement procedures produce the selected accuracy target.

6. Tracer-Velocity-Area Methods

Either salt or dye may be conveniently used in tracer-velocity-area discharge measurements with equal potential accuracy. The only difference is that different detection equipment is needed. Dyes have an added advantage in that they can be detected visually, allowing simpler measurements of less accuracy that may be sufficient for irrigation needs. However, when using any simpler method, the error checks and mixing problems of section 5 in chapter 12 should be considered.

(a) Salt-Velocity-Area Measurements

The salt-velocity-area method takes advantage of the fact that salt in solution increases the electrical conductivity of water. This method has been successfully used in open channels and pressure conduits of constant cross section.

Because of its high potential accuracy, the salt-velocity-area method is one of several methods accepted for turbine testing in American Society of Mechanical Engineers (1992). The equipment described in Thomas and Dexter (1955), consisting of injection system and the sensing electrodes (figures 12-1 and 12-2), are rather complex. Also, a turbulator is sometimes used to ensure adequate mixing of the injected salt tracer solution and the flow by the time they reach the first electrode station. Full details regarding the equipment required for techniques found satisfactory under field conditions are contained in Thomas and Dexter (1955).

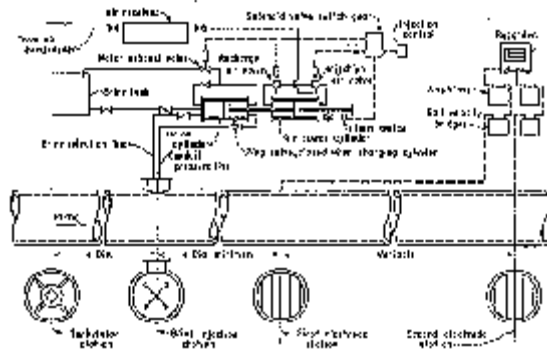


Figure 12-1 -- General arrangement of salt-velocity equipment for pressure conduits.

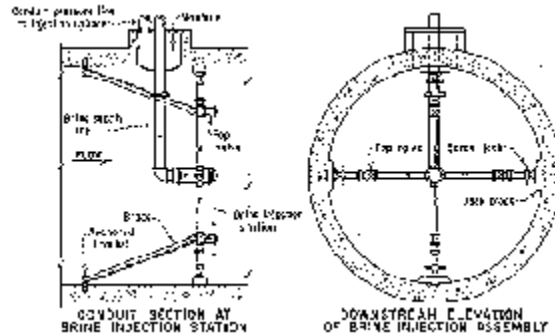


Figure 12-2 -- Brine injection equipment in conduit.

Commonly, sodium chloride (NaCl) is the selected salt used in the tracer injection solution. Finely ground salt should be purchased for ease in mixing the solution. Enough salt must be added to significantly increase the electrical conductivity of the water so that concentrations can be measured accurately. The required amount of salt can be estimated by analyzing the water for existing background quantity of salt in the measurement flow, estimating the amount of flow to be measured, and using chemical handbook data from conductivity-salinity tables. Trial runs may be needed to determine the optimum amounts, which may vary with discharge depending on the range to be measured.

For a measurement, a quantity of salt tracer solution is forced into the stream under pressure to provide better initial distribution and assure thorough mixing before arrival at the detection stations. The pop valve injector used by Thomas and Dexter (1955) (figure 12-2) will provide the faster and better mixing required to produce code accuracy.

To determine velocity for equation 12-1, a pair of electrodes is installed in the cross section at each end of a measured length of channel well downstream from the injection system. The distance between the pairs of electrodes should be sufficient to ensure accurate measurement of the time of travel between them. The electrodes are electrically energized and connected to a central instrument that records the electrical conductivity at each pair of electrodes with respect to time.

A sample of a strip chart recording showing conductivity change that occurs as a salt cloud passes the electrodes is shown on figure 12-3. The recording shows a conductivity rise that indicates the passing of the salt solution cloud past each electrode station.

In addition to their peaks, the cloud plots have a leading and a trailing edge of low conductivity approaching the baseline conductivity of the flowing water (figure 12-3). The time of cloud travel between electrodes is measured on the chart time scale between the centroids of the two plotted conductivity cloud areas above the background conductivity level. Digital recordings are more convenient than analog recordings for computer determination of area under the time-conductivity plots to determine the center of mass of salt clouds.



Figure 12-3 -- Sample records of a salt cloud passing upstream and downstream electrodes in the salt-velocity method of measuring flows in pipelines.

This method requires special equipment and experienced personnel and is relatively expensive. Care in selecting convenient reaches will help reduce time and expense in measuring length and determining an accurate average cross-sectional area.

(b) Color-Velocity Measurements

To achieve maximum accuracy using dye tracer solutions, the procedures similar to those described for the salt-velocity-area method must be followed. However, fluorometer detection or a set of visual color comparison standards must be used instead of equipment used for salt solution injections. Carefully following American Society of Mechanical Engineers *Performance Test Codes* (1992) will result in very accurate discharge measurements. Fluorometry combined with well designed multiple port injection and sampling port arrangements at two stations downstream from an injection station produces high accuracy.

The simpler but less accurate method using visual observation for tracer cloud detection in pipelines consists of determining the velocity of a dye tracer between two stations in the pipe. This velocity, used as the mean velocity of flow, is multiplied by the cross-sectional area of the pipe to give the discharge as shown in equation 12-1.

The simplified procedure ordinarily used in making the velocity measurements is described below. If possible, a small slug of concentrated dye solution is quickly injected or poured into the pipeline entrance where the pressure is relatively low. In pipes, a high-pressure system through fittings may be required to inject dye. Time observations are made at the instant the dye is injected and at its first and last appearance at the downstream station, usually at the pipe outlet. The mean velocity is computed from the mean time required for the dye to travel the known length of reach. Comparisons with other measurement methods show this simplified color velocity method is accurate enough for irrigation measurements when properly done in relatively long pipes.

Simplification similar to the pipe flow case is possible in open channel flow. However, the color-velocity-area method in open channels has more limitations and drawbacks. The air entrained by surface velocities and spray above the surface may hinder detection of the position of the center of mass of the colored water in high-velocity flows (Hall, 1943). Also, slow flows are more likely to cause mixing problems.

7. Tracer-Dilution Methods

The tracer-dilution method is capable of measuring both open channel and closed conduit flow. However, possible tracer losses may be more of a problem in open channel flow as discussed previously. Either salts or dyes may be used as tracers. The tracer-dilution method consists of adding a known, strong concentration of tracer solution, C_1 (equation 12-2) at a constant rate, to the flow (Schuster, 1970; Collins and Wright, 1964; and University of Newcastle on Tyne, 1964). Then, by chemical analysis, the downstream diluted uniformly mixed concentration, C_2 , is measured. The solution must be added at a known constant discharge, q .

No measurements of flow section geometry or reach distance are required because the total flow is measured directly. The discharge of the channel flow, Q , is measured by determining C_0 , C_1 , C_2 , and the injection rate, q . These required variables and equation 12-2 show that the dilution method does not need measurement of channel geometry or time measurement. Only the final plateau value or C_2 , the downstream concentration, must be recorded rather than a complete record of the passing cloud that is needed with the salt-velocity-area method.

Because the concentrated tracer solution must be added to the flow at a constant known rate, positive displacement metering pumps are needed for injection. Also, this method requires a sufficient flow travel length with enough turbulence to thoroughly mix the dye. Required mixing lengths can perhaps be reduced by turbulators or injecting the dye simultaneously at a number of points across the stream, but the injection arrays may need prevalidation by analysis and preliminary measurement runs to assure complete mixing.

If salt solutions are used as tracers, then chemical or conductivity measurement methods are used for detection and concentration measurements. Finely ground salt should be purchased for ease in mixing the solution if selected as the tracer. If dyes are used, then visual color intensity comparison standards may be used. Modern fluorometers can measure dye amounts to one part of dye in a million parts of water and can detect one part in a billion. The human eye cannot detect these minute dilutions, but the dye is quite discernible to the instrument.

The color-dilution method may be used for measuring small, medium, or large flows because the cost of the dye is relatively low. The salt-dilution method is applicable to measuring discharges in turbulent streams of moderate or small size where other methods are impracticable. Excessive quantities of salt are required on large streams.

Tracer methods require special equipment and experienced personnel, and its use is relatively expensive. The injection equipment and electrodes or fluorometers for detecting and measuring the tracer concentration of the resulting downstream diluted flow make this method quite costly compared to other measuring methods.

8. Bibliography

American Society of Mechanical Engineers, "Performance Test Codes-Hydraulic Turbines and Turbine Mode of Pumps/Turbines," revision, Performance Test Code Committee, No. 18, New York, NY, 1992.

British Standards Institution, "Method of Measurement of Liquid Flow in Open Channels," *British Standards* 3680, Part 3, 1964.

Collins, M.R., and R.R. Wright, "Application of Fluorescent Tracing Techniques to Hydrologic Studies," *Journal of the American Water Works Association*, June 1964.

Hall, L. Standish, "Open Channel Flow at High Velocities," *Transactions*, Paper No. 2205, vol. 108, American Society of Civil Engineers, p. 1394, 1943.

Schuster, J.S. (ed.), "Water Measurement Procedures-Irrigation Operators' Workshop," Report No. REC-OCE-70-38, Bureau of Reclamation, Denver CO, September 1970.

Thomas, C.W., and R.B. Dexter, "Modern Equipment for Application of Salt Velocity Method of Discharge," *Proceedings of the Sixth General Meeting*, vol. 2, International Association of Hydraulic Research, the Hague, Netherlands, 1955.

University of Newcastle on Tyne, *Dilution Techniques for Flow Measurement*, Bulletin No. 31, February 1964.

CHAPTER 13 - SPECIAL MEASUREMENT METHODS IN OPEN CHANNELS

1. Introduction

Open channel flow measuring devices and methods described in chapters 6 through 10 are ones most commonly used for measuring irrigation water in the United States. Their relative simplicity makes them well suited for general use, and long experience has established their reliability. Tube-type flowmeters are installed in or at the end of pipes passing through embankments to laterals or ditches. Sometimes, these tubes are considered open channel measuring devices. Tube-type flowmeters are discussed in chapters 2, 11, and 14. Other specialized methods and devices for measuring water in open channels follow.

2. Open Flow Propeller Meters

Besides being used in closed conduit systems, propeller meters are frequently placed at the end of pipes delivering water to open channels ([figure 14-6](#) in chapter 14). When used this way, they are often called open flowmeters. The requirements and maintenance problems inherent to these meters are discussed more thoroughly in chapter 14, which should be read along with the following information.

These meters should be installed in open channels that submerge the pipe exit or have small overflow check structures that assure submergence for the desired discharge range. Meters are available for pipe diameters from 2 to 72 inches (in). These meters need sufficient driving velocity and are likely to be inaccurate below 1.5 feet per second (ft/s). Spiral flow caused by poor entrance conditions from the canal to the supply pipe is a common source of error. Straightening vanes provided or specified by manufacturers should be installed. A poorly developed velocity distribution profile can also cause considerable errors in registration.

The accuracy of propeller meters is generally within +/-2 to +/-5 percent of the actual flow. However, careless setting of the meter in the turnout will cause sizable errors if the meter is not properly positioned (Schuster, 1970). For example, a meter with a 12-in-diameter propeller, suitable for measuring discharges up to 8 cubic feet per second (ft³/s) in a 24-in-diameter pipe, when set with the hub center 1 in off the center of the pipe, showed an error of 1.2 percent. When the meter was rotated 11.5 degrees in a horizontal plane, equivalent to 1/4 in measured on the surface of the 22-in-diameter vertical meter shaft housing, the error was 4 percent, indicating that a small angular misalignment of the meter will cause a greater error than would be caused by a moderate eccentricity.

3. Deflection Meters

These meters are out of production for irrigation use. However, some are still in use. These meters have some advantages, and they may come back into production. Deflection meters consist of a shaped vane(s) that projects into the flowing water to sense velocity. A secondary device measures the deflection caused by the force of the flow. These meters can be installed permanently or may be easily moved from one location to another. In use, they hang into the flow and are supported on pivots.

Vanes can be shaped to match the flow section geometry to make them deflect the same amount for any given discharge regardless of the depth of flow in the flow section.

This attribute is a considerable advantage where the head-discharge characteristic of the channel is unstable. Flow sections with permanent pivots can be installed at various locations in an irrigation district, and the vanes can be transported from measuring station to measuring station.

Under ideal conditions, deflection meters have been found to be accurate within 2 percent. Generally, this accuracy will not be attained because field conditions are seldom ideal. For example, wind can produce errors up to 100 percent. However, a windbreak made from a piece of plywood will substantially reduce this kind of error.

4. Measuring Controls for Canals

Irrigation canal systems frequently include drops to adjust canal grades to the landscape. If the drop is great enough to make the flow pass through critical depth, a gage set in the canal a short distance upstream from the drop may be used to measure heads that, with calibration, can be related to discharge. Measured flow must pass through critical depth for the entire needed discharge measurement range. Chapter 2 has a section on critical depth. Discharge ratings are developed by current metering at various depths to produce tables and curves. In some channels where sufficient freeboard exists, side or bottom constrictions can be added, and a gage can be calibrated similarly. Measuring controls operate with the same principles as flumes and weirs but need special calibrations.

5. Calibration of Gates and Sluices

In many irrigation distribution systems, the flow of water is measured through gates and sluices. This measurement necessitates calibrating the gates and sluices.

In calibrating an individual gate, the discharge can be measured by any of the standard methods described in earlier chapters of this manual. A series of discharge measurements covering the range of openings is made, and the mean operating heads upstream and downstream from the gate are recorded for each measurement. For convenience when operating the gates in regular service, rating curves and tables may be compiled to provide the discharge in cubic feet per second (ft^3/s) for each opening and series of operating heads.

In calibrating sluices that meet the requirements of rating sections, the current-meter method is commonly used. It may also be practical to calibrate the sluice with a temporary weir, provided sufficient fall is available. The calibration consists of measuring the discharge for various depths of flow in the sluice at a rating station and plotting the discharges against depths. The channel should be of regular section and free from disturbance caused by upstream conditions such as bends, multiple gates operating at unbalanced openings, waves, and other distorting influences.

6. Slope-Area Method

The slope-area method consists of using the slope of the water surface in a uniform reach of channel and the average cross-sectional area of that reach to give a rate of discharge. The discharge may be computed from the Manning formula:

$$Q = \frac{1.486}{n} A R_h^{2/3} S^{1/2}$$

where:

Q = discharge (ft³/s)

A = mean area of the channel cross section (ft²)

R_h = mean hydraulic radius of the channel (ft)

S = energy slope of the flow

n = a roughness factor depending on the character of the channel lining

A straight reach of the channel should be chosen at least 200 ft and preferably 1,000 ft in length. If the reach is free of rapids, abrupt falls, or sudden contractions or expansions, then the water surface slope is the same as the energy slope.

The slope, S , may be determined by dividing the difference in the water surface elevations at the two ends of the reach by the length of the reach. A gage point, carefully referenced to a common datum level, should be placed on each bank of the channel and in the center of the reach, in stilling wells if possible.

The hydraulic radius, R_h , is defined as the area of the cross section divided by its wetted perimeter. Where the channel or canal is of regular cross section, and the depths at the ends of the course are equal, the area and the wetted perimeter will be constant through-out the course. In irregular channels, the area and the wetted perimeter at several cross sections will be required, and a mean value will be used in computing the hydraulic radius. A static pressure tube, discussed in chapter 8, can be used to measure depth of flow.

The factor, n , depends on the character of the channel. It may vary from 0.010, where conditions approaching the ideal are maintained, to 0.060, where the channel is strewn with stones and debris or is about one-third full of vegetation.

Because the proper selection of the roughness factor, n , for many streams is difficult and is, at best, an estimate, the discharge determined by the slope-area method is only approximate. Care must be taken to determine the slope and areas simultaneously if the water levels are changing. Chapter 2 provides other flow equations, their friction factors that can be used with this method, and references with tables of friction factors.

7. The Pitot Tube

Pitot tubes are sometimes used to measure relatively fast velocities such as at drops, chutes, and overfall crests. Velocity traversing and discharge computations may be done in the same manner as with current metering (described in chapter 5). Pitot tubes are difficult to use in slow canal flow because they produce small differentials in slow flow. For example, the velocity needed to produce 0.1 ft velocity head is 2.6 ft/s.

Thus, pitot tubes have the problem of precision of head measurement relative to the size of head differential. Depending on needed accuracy, the secondary equipment could be costly and difficult to use in slow velocity. Pitot tubes and their use are more fully described in chapter 14.

8. Accounting of Inflow and Outflow From Reservoir Storage

When gain or loss in storage of a reservoir and the inflow to a reservoir are known, the outlet discharge may be computed. Conversely, when the storage, gain or loss, and the reservoir outlet discharge are known, the inlet flow may be computed.

In each of these computations, the gain or loss in storage during a given time period may be read from reservoir capacity charts and tables. These charts and tables generally give the reservoir volume in acre-feet for various gage heights of water. The change in reservoir volume for the time period is converted to cubic feet per second (ft^3/s). The change of reservoir discharge increased by the inflow or decreased by the outflow gives the average discharge or inflow, respectively.

Bank storage causes indeterminate deviation. Storage will tend to cause a slow drop in reservoir water surface when the net rate of outlet flow is low and will retard rise in water surface during a slow increase in storage. These changes usually are imperceptible to an observer. Adjustments for evaporation and wind effect on gage readings may be necessary in reservoirs of large areas.

9. Weir Sticks

Weir sticks are commercially calibrated stick or staff gage type devices which may be placed by hand upon the crest of a weir. In principle, the sticks show depth of flow plus velocity head or the runup of water above the water surface at the weir blade. This device gives an indication of the head that would have been measured at conventional weir measurement stations. Readings are taken at the top of the runup of water to indicate the rate of flow. Some sticks contain a piezometer and manometer to average the pulsations in the head reading. Turning the stick to an angle will not improve accuracy unless the stick has been calibrated in this position.

At best, the sticks can only approximate the potential accuracy of weirs when head is carefully measured in the normal manner. Weir sticks are designed to measure unit discharge along the crest of rectangular suppressed weirs. Thus, the gage indicates the discharge per unit length of weir. The design intent was to make weir measurements simpler without need for staff gage zero setting. Also, poor distribution of velocity of approach at the crest could be accounted for by multiple stick measurements and averaging along the crest because the weir stick measures the depth on the crest and the corresponding velocity head. Thus, they compensate for velocity of approach, such as caused by sediment deposits ahead of the weir blade.

10. Measurement by Floats

The approximate velocity of flow in a canal or stream and discharge may be determined by the use of floats (British Standards Institution, 1964). Because a number of other methods are usually easier and more accurate to use, this method should be used only when the other methods are impractical or impossible. A reach of canal, straight and uniform in cross section and grade and with a minimum of surface waves, should be chosen for this method.

Surface velocity measurements should only be attempted on windless days to avoid wind-caused deflection of the floats. Even under the best conditions, surface floats are often diverted from a direct course between measuring stations because of surface disturbances and crosscurrents. Surface floats are immersed one-fourth or less of the flow depth. Rod floats are submerged more than one-fourth of the depth but do not touch the bottom.

Cross sections are established along the straight reach of the channel at a beginning, midpoint, and end. The cross sections should be located far enough apart so the time interval required for the float to travel from one cross section to another can be accurately measured. The midpoint cross section provides a check on the velocity measurements made between the beginning and end sections. The channel width across the sections should be divided into at least three, and preferably at least five, segments of equal width. The average depth of each segment must then be determined. The float must be released far enough upstream from the first cross section to attain stream velocity before reaching the cross section. The times at which the float passes each section should be observed by stopwatch and recorded. The procedure is repeated with floats in each of the segments across the canal, and several measurements should be made in each segment.

For flows in canals and reasonably smooth streams, the measured surface float velocities should be multiplied by the coefficients as listed below:

Average depth in reach (ft)	Coefficient
1	0.66
2	0.68
3	0.70
4	0.72
5	0.74
6	0.76
9	0.77
12	0.78
15	0.79
>20	0.80

The corrected velocities should then be multiplied by the cross-sectional area of the corresponding stream segments to obtain the segment discharges. The sum of the segment discharges will be the total discharge.

A method used extensively in India to determine velocities in open channels makes use of rod or tube floats. This device consists of a square or round wooden rod with a width or diameter of 1 to 2 in, depending on the length. The rod is designed with a weighted end so it will float in a vertical position with the length of the immersed portion about 0.9 times the depth of the water. This method is based on the reasonable assumption that the velocity of a rod float extending from the water surface to very near the bottom of a channel will closely represent the mean velocity of the water. Streams are divided into segments as described for the float method, except that velocities in areas near the banks of the channel are not measured by the rod method but are assumed to be two-thirds or three-quarters of the mean velocity of adjacent segments.

The rod float method may be used in canals with straight stretches that are regular and uniform in cross section and grade. Where these conditions exist and the flow is free of cross currents and eddies, discharge measurements may be made with a high degree of accuracy.

The accuracy of float methods are limited by many factors, including a lack of preciseness in the coefficients, too few stream segments being used, appreciable changes in stream depth along the test reach, oblique currents, wind forces, and experimental errors in measuring time and distances. Often, a number of people are required to perform this technique and make observations. The course of the floats is difficult to control, and they can be easily retarded by dragging on submerged debris and on the sides and bottom of the channel.

CHAPTER 13 - SPECIAL MEASUREMENT METHODS IN OPEN CHANNELS

11. Bibliography

British Standards Institution, "Method of Measurement of Liquid Flow in Open Channels," *British Standards* 3680, Part 3, 1964.

Schuster, J.S., Ed., "Water Measurement Procedures-Irrigation Operators' Workshop," REC-OCE-70-38, U.S. Bureau of Reclamation, Denver, Colorado, 1970.

CHAPTER 14 - MEASUREMENTS IN PRESSURE CONDUITS

1. Introduction

Using pipelines instead of open channels has many advantages. Pipelines prevent loss of water by evaporation and seepage. Operation and maintenance costs are reduced because less land is waterlogged, and the need for canal weed prevention and removal is eliminated. Land that would be occupied by canals and embankments is available for crop production or other uses. Buried pipelines, compared to open canals, are safer for animals and people. In general, pipelines have a higher initial cost, but as the value of water, land, and labor increases, the use of pipelines becomes more economically feasible. Thus, accurate flow measurement in pipelines becomes increasingly important.

Pipeline flow can be measured in many ways. Selection of a particular installation depends upon specific local situations. The accuracy of flow measurements in pressure conduits can be very high. However, measuring devices and techniques must be properly selected, installed, used, and maintained.

2. General Comments on Pipeline Flowmeters

In-line flowmeters are usually classified by basic types of operation. Some of these basic types are:

- Differential head meters
- Positive volume displacement summing meters (generally municipal water)
- Calibrated velocity sensing meters
- Measured proportional or calibrated bypass meters
- Acoustic-type meters

Flowmeters can display or record total volume delivered or instantaneous discharge rates. Direct reading of totalized volume, rather than computing volume from instantaneous discharge readings, is especially convenient where water is sold on the volume basis. Many flowmeters are also equipped with auxiliary equipment to record and display the instantaneous flow discharge. This feature is of great advantage for irrigation when setting rates and controlling delivery.

Water measured in closed conduits with mechanical meters must be free of foreign matter. Meters should be inspected regularly (see chapter 5) to detect wear, corrosion, or other change that would tend to alter accuracy. Flowmeter use is limited by relatively high cost and short life in adverse operating environments.

3. Differential Head Flowmeters

This class of flowmeters includes venturi, nozzle, and orifice meters. When properly installed and used, these meters have a potential accuracy of "1 percent. These meters have no moving parts but use the principle of accelerating flow by some form of constriction. Heads are measured upstream where the meter is the size of the approach pipe and downstream where the area is reduced to a minimum.

The basic energy balance relationship is written as discussed in chapter 2. The velocity at one of these locations is solved for in terms of the difference of head between the two locations. Using the product of the upstream velocity and area results in discharge expressed as:

$$Q_a = CA_1A_2 \sqrt{\frac{2g(h_1 - h_2)}{A_1^2 - A_2^2}} \quad (14-1)$$

where:

- Q_a = discharge
- A_1 = upstream approach area
- A_2 = area of the throat or orifice opening
- h_1 = upstream head measurement
- h_2 = downstream head
- g = gravity constant
- C = coefficient determined experimentally

The term, $h_1 - h_2$, often written in shorter form as Δh , is the differential head that gives the name to this class of meters.

The values of the effective discharge coefficient in both of the equation forms, for the same differential flowmeter, are the same. The coefficients are the same because the area divided by the square root of the denominator in each equation has the same value.

Equation 14-1 is valid for the venturi, nozzle, and orifice meters using proper respective effective coefficients. Each kind of flow meter has a different value of effective discharge coefficient. More details concerning what is accounted for by the effective discharge coefficient are covered in chapter 2.

With differential flowmeters, the pressure difference between the inlet tap and the throat or minimum pressure tap is related to discharge in tables or curves using the suitable coefficients with the proper equation. An example discharge curve is shown for an 8-inch (in) venturi meter on figure 14-1. Thus, the meters may serve as reliable flow measuring devices.

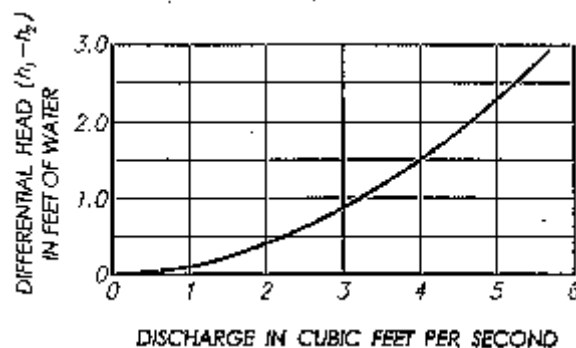


Figure 14-1 -- Typical calibration curve for an 8-in venturi meter - one kind of differential flowmeter.

(a) Venturi Meters

Venturi meters (figure 14-2) are one of the most accurate type of flow measuring device that can be used in a water supply system. They contain no moving parts, require very little maintenance, and cause very little head loss. Tables or diagrams of the head difference versus rate of flow may be prepared, and flow indicators or flow recorders may be used to display the differential or rate of flow. Venturi meters are often used in the laboratory to calibrate other closed conduit flow measuring devices.

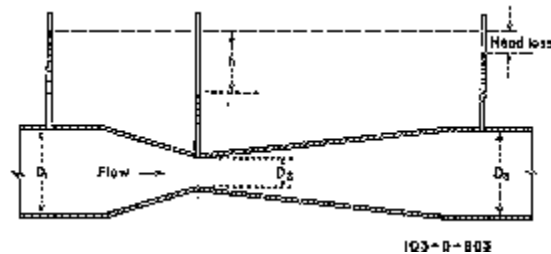


Figure 14-2 -- Sectional view of venturi meter.

The American Society of Mechanical Engineers (1983) and International Organization for Standardization (1991) contain details of pipeline meter theory, equations, coefficients, and tables with application instructions.

The effective discharge coefficient for venturi meters ranges from 0.9 to about unity (Streeter, 1951; American Society of Mechanical Engineers, 1983) with turbulent flow, and it varies with diameter ratio of throat to pipe.

The smaller commercial venturi meters are made of brass or bronze and are available for pipe sizes up to about 2 inches (in) diameter. Larger meters are usually made of cast iron with inner bronze linings. Some larger venturi meters have been constructed of concrete with the convergence and the throat made of finished metal. Large venturi meters have not been standardized for general irrigation practice, and the sizes, shapes, and coefficients are not well known. Accuracy and performance should be specified by purchase contract for large venturi meters. Some relatively simple and effective venturi meters have been made from precast concrete (Summers, 1952; 1953) and plastic (Replogle and Wahlin, 1994) pipe sections and fittings.

In the past, the expense of venturi meters and the fact that they must always operate with full pipelines have restricted their use on a broad scale in irrigation systems. The increasing demand for accurate flow measurements in pressure conduits will likely result in greater use of venturi meters in the future. Because venturi meters have smoothly varying flow boundaries, they have been used for measuring sewage and flow carrying other materials. Sometimes, this usage may require clean water backflushing for clearing manometer tubing. With trash-carrying flow that would require frequent flushing, small continuous purging flows have been used to keep material from plugging or entering the pressure taps between and during pressure head measurements. Many variations of the meter exist, each of which is tailored to meet the requirements of specific types of installations.

(b) Nozzle Meters

In effect, the flow nozzle is a venturi meter that has been simplified and shortened by eliminating the gradual downstream expansion (figure 14-3). The streamlined entrance of the nozzle causes a straight jet without contraction, so its effective discharge coefficient is nearly the same as the venturi meter. Flow nozzles allow the jet to expand of its own accord. This feature causes a greater amount of turbulent expansion head loss than the loss that occurs in venturi meters, which suppress exit turbulence with a gradually expanding tube boundary.

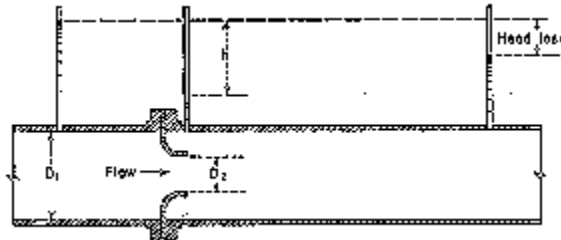


Figure 14-3 -- Sectional view of nozzle meter.

The effective coefficient of discharge for flow nozzles in pipelines varies from 0.96 to 1.2 for turbulent flow and increases as the throat-to-pipe-diameter ratio increases.

Frequently, the upstream pressure connection is made through a hole in the wall of the conduit at a distance of about one pipe diameter upstream from the starting point of the flare of the nozzle (ASME, 1983). Thus, the pressure is measured before it curves to enter the nozzle. The downstream pressure connection may be made through the pipe wall just above the end of the nozzle tube (ASME, 1983).

Flow nozzles have been made from precast concrete pipe and used in the field. Flow nozzles have not been used extensively for measuring irrigation water, probably because this application lacks standardization. Discharge tables provided by a manufacturer agreed closely with independent calibration tests and studies (Summers, 1952).

(c) Orifice Meter

The most common differential-pressure type flowmeter used in pipelines is the sharp-edged orifice plate (figure 14-4). These meters are frequently used in irrigation applications for measuring well discharges and agricultural chemicals that are injected into irrigation flows. The latter are usually small with details of installation and operation furnished by the manufacturers. Therefore, only larger diameter orifice plates in round pipes will be discussed here. Personal computers and the generalization of discharge coefficients renewed interest in the orifice as a primary device (Furness, 1987).

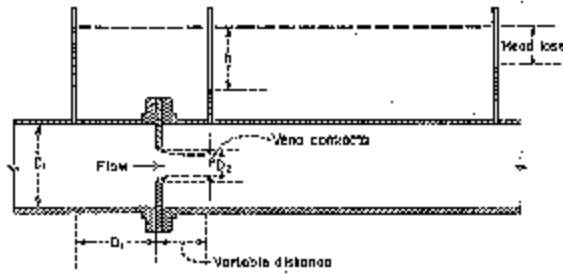


Figure 14-4 -- Sectional view of orifice meter.

Applications with proper water quality, careful attention to installation detail, and proper operation techniques (Hobbs, 1987) make these flowmeters capable of producing accuracy to within 1 percent. However, the usual maintenance and pipe conditions that generally occur in irrigation pipe systems limit field accuracies to within 3 to 5 percent of actual.

Advantages of the orifice plate are its simplicity and the ability to select a proper calibration on the basis of the measurements of the geometry (Dijstelbergen, 1982). Disadvantages of the orifice plate include the long, straight pipe length requirements and the limited practical discharge range ratio of about one to three for a single orifice hole size. However, the location of the range can be shifted by using sets of plates for changing orifice hole sizes. This shift, in effect, provides a range ratio increase. Calibrations based on tap locations relative to pipe diameter, rather than orifice diameter, make this feasible because the same tap locations can be used for different orifice plate hole sizes.

(1) The Flow Rate Equation

The equation now commonly used to calculate the flow rate from the pressure differential and other relevant parameters is:

$$Q = CC_v A \sqrt{2g\Delta h} \quad (14-2a)$$

$$Q = C_d A \sqrt{2g\Delta h} \quad (14-2b)$$

where:

- Q = the discharge
- C_d = the product CC_v
- C = a coefficient determined experimentally
- C_v = the velocity of approach factor
- A = the area of the orifice hole
- g = the acceleration of gravity
- Δh = the differential head

If differential pressure sensing equipment is used as the secondary measuring devices, then $2g\Delta h$ must be replaced with $2\Delta P/D$, where ΔP is differential pressure and D is the density of the flowing water.

(2) Standardization of Tap Locations

Originally, the so-called vena-contracta tap (minimum contracted orifice jet diameter) was standardized. For those, the location of the downstream tap depended on the orifice hole size in the orifice plate. This diminished the possibility of altering the range by changing orifice plates because theappings would also have to be relocated for each new plate size.

More recent orifice standards are based on extensive experimental data and can be applied with a fair degree of confidence. Studies carried out in Germany, the United States, France, and Britain resulted in the present ISO-5167 (1991) (adapted from British Standards-1042 [1943], and Dijstelbergen [1982]). The standards list the geometry of the devices, the installation conditions to be observed, and the equation relating flow and pressure differential. Three types (figure 14-5) of differential measuring taps as internationally standardized are:

- Corner taps
- Flange taps
- $D-D/2$ taps

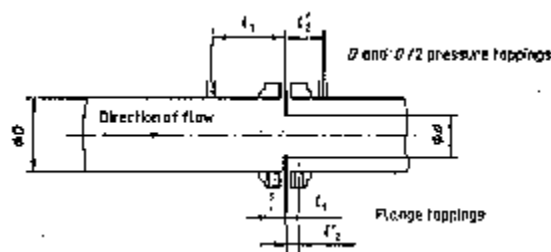


Figure 14-5 -- Flange and $D-D/2$ pressure taps for orifice meter.

(3) Orifice Plate and Hole Requirements

Orifice plates require careful installation. The orifice plate coefficient is generally affected more by misalignment and disturbed velocity distributions than other differential-pressure meters because the abrupt pressure changes take place near the plate. Poor installation of an otherwise properly designed orifice plate can cause as much as a 20-percent error (Humphreys, 1987). The orifice plate should be mounted in such a way that it is possible to inspect at least the orifice plate and preferably the adjacent piping.

The orifice hole diameter should be at least 0.5 in, and its upstream edge should be free of visible dents, burrs, and rounding. The orifice hole must be bored perpendicular to the plate. The bore hole cylinder length must be between 0.005 and 0.02 times the pipe diameter (D). If the plate is thicker than $0.02D$, the downstream orifice must be beveled at an angle between 30 to 60 degrees from horizontal. Centering of the plate orifice hole, as specified in the standard, is particularly difficult to meet for small pipes.

The plate shall be mounted perpendicular to the pipe axis. The orifice plate material should be thick enough so it will not bow under the differential pressure. The plate faces shall be flat and parallel. The plate thickness shall be less than 0.05 times the pipe diameter, and its upstream face shall have a quality finish.

(4) Meter Approach and Exit Requirements

Downstream from pipe fittings, the required length of straight pipe approaching orifice meters varies with type, number, and orientation of fittings and increases in proportion to β (ratio of orifice to pipe diameter). For example, a single 90-degree bend requires from 6 to 18 diameters of straight approach pipe ahead of the upstream pressure tap for β increasing from 0.2 to 0.75 (ISO, 1991). Two 90-degree bends in the same plane require 7 to 21 diameters for the same β range. Two or more bends in different planes require 17 to 35 diameters. Globe valves require 9 to 18 diameters for β increasing from 0.2 to 0.75. Gate valves require 6 to 15 approach diameters. An expander fitting requires 8 to 19 diameters. A reducer fitting requires 5 to 15 diameters of straight pipe upstream for β ranging from 0.5 to 0.75, which differs from the previously mentioned values. Four to eight diameters of straight pipe are required downstream from the pressure taps.

(5) Coefficient of Discharge

Accurate values for C_d have been developed for the standard tap locations. If the orifice-plate geometry and its installation conform to the orifice specifications of ISO 5167, a good estimate of performance can be developed by applying the Stolz equation appearing in those standards. This equation was developed by Stolz, who logically showed that the coefficients of the different taps normalized by pipe diameter are related. Thus, the value of the coefficient of discharge, C_d , depends on the particular tapping arrangement, the Reynolds number (Re) (VD/ν), and the diameter ratio, β , as defined in equation 14-3. Originally, the older coefficients were separately determined for each tapping arrangement for specific orifice hole sizes.

In large pipe diameters, for example, the coefficient of the corner taps and flange taps should not differ. For small area ratios, all coefficients for different taps should be equal. Stolz statistically fitted the available data resulting in the unified equation given in ISO 5167 covering all tapping arrangements. This equation for C_d is:

$$C_d = 0.5959 + 0.0312 \beta^{2.1} - 0.1840 \beta^8 + 0.0029 \beta^{2.5} (10^6/Re)^{0.75} \\ + 0.0900(L_1/D)[\beta^4/(1 - \beta^4)] - 0.0337 (L_2/D) \beta^3 \quad (14-3)$$

where:

C_d = coefficient of discharge

L_1 = the tap distance from the upstream face of the plate

L_2 = the tap distance from the downstream face of the of the orifice plate

D = the pipeline diameter

β = the ratio of orifice diameter to pipe diameter

Re = the Reynolds number (VD/ν)

V = the pipeline velocity

ν = the kinematic viscosity of the water

The minimum allowable Reynolds number varies with diameter, tapping arrangement, and β . The Reynolds number (VD/ν) for flange and ($D-D/2$) taps must be greater than $1,260 \beta^2 D$. For corner taps Reynolds number must be greater than 10,000 for β greater than 0.45. For β less than 0.45, the Reynolds number must be greater than 5,000.

The first three terms of equation 14-3 give the corner tap coefficient when Reynolds number (Re) effect is insignificant. The fourth term introduces Reynolds number effect. The last term accounts for the distance of flange and $D-D/2$ taps from the upstream face of the orifice plate. Although the equation appears to give a coefficient value for all tapping locations, standardized or not, it was not developed with data for other than standard locations and, therefore, is not recommended for nonstandard tapping locations. The coefficients by this equation are substantially the same as found in older presentations. Differences come mainly from the data fitting method. Uncertainty of the coefficient is claimed to be less than ± 1 percent, exceeding the usual requirements for irrigation use.

The equation which relates flow rate to head differential and other parameters may seem to be rather complicated but is a minor inconvenience with modern computer capabilities. For the usual irrigation practice that accepts meter accuracies within ± 3 percent or more, the above precautions can be relaxed considerably.

4. Propeller Meters

Propeller meters are commercial flow measuring devices used at the ends of pipes and in conduits flowing full and under pressure (figure 14-6). The uses of propeller meters at the end of pipes (open flow propeller meters) are discussed in chapter 13. Propeller meters use multiple blades made of rubber, plastic, or metal. The propeller rotates on a horizontal axle geared to a totalizer that displays total volume that has passed the meter. The propellers are sometimes hung from a sealing plate with a gasket to seal around a saddle opening on the top of the pipeline. Others have propellers supported by spiders in short, permanent tubes for connection into pipeline flow. Some meters also display instantaneous discharge rate with indicator hands on dials.

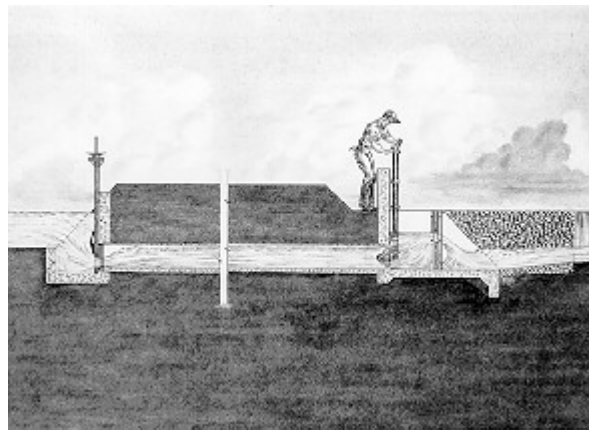


Figure 14-6 -- Typical propeller meter installation.

The meters are available for a range of pipe diameters from 2 to 72 in. They are normally designed for water flow velocities up to 17 feet per second (ft/s). The accuracy of most propeller meters varies from ± 2 to ± 5 percent of the actual flow. Greater accuracy is possible, and minimum driving velocities as low as 0.5 ft/s are sometimes claimed for certain meters. These claims may, at times, be justified; however, they are sometimes difficult to verify or reproduce, even in carefully controlled laboratory tests. Small changes of frictional resistance of bearings and other mechanical parts caused by wear can cause large deviations from calibration, especially at the low discharge end of measurement range.

With wear, error increases greatly for velocities below 1 to 1.5 ft/s. Propeller meters should be selected to operate near the middle of their design discharge range. This equipment can be a problem in existing irrigation systems with oversized pipes relative to delivery needs. Sections of the oversized pipe may need to be replaced with smaller pipes to provide enough velocity and approach pipeline length to allow development of velocity profiles.

Any condition that makes the approach flow different from calibration conditions affects the accuracy of the meter registration. Insufficient driving velocity relative to friction, unusual velocity distributions, or undeveloped velocity profiles and spiral flow can cause considerable errors.

If the propeller diameter measures less than half of the pipe diameter, the meter will be more sensitive to velocity profile differences. Changes in velocity distribution or velocity profile also influence registration. If the conduit from the canal to the meter is less than about six diameters long, typically, flow does not have sufficient time to develop a normal velocity distribution profile. This condition results in a blunt, evenly distributed velocity pattern (figure 14-7, case A). However, a conduit length of 20 to 30 diameters or longer will allow a typical, fully developed velocity profile (figure 14-7, case B).

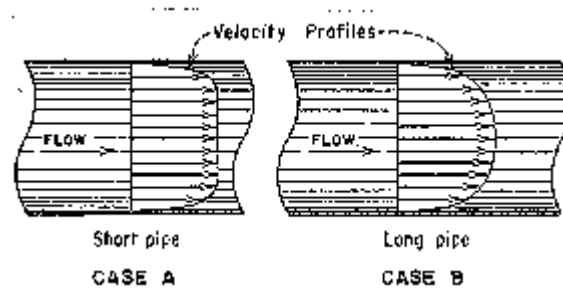


Figure 14-7 -- Velocity distributions in a pipeline.

With a fully developed velocity profile (case B), the velocity of flow near the center of the pipe is high, compared to the velocity near the walls. Thus, a meter with a propeller diameter of only half that of the pipe diameter would read 3 to 4 percent higher in this flow distribution than it would in the flat velocity profile (case A). Larger propellers up to 0.8 of the pipe diameter sample more of the flow velocity, producing greater potential accuracy. Laboratory tests show this statement to be true; and when the propeller diameter is 75 percent or more of the pipe diameter, the variation in registration caused by these velocity profile changes are minor.

Spiral flow is caused by poor entrance conditions and combinations of bends and fittings such as valves. Measurement errors caused by spiral flow can be large and, depending on spiral rotational direction of the flow, are either positive or negative.

Normally, the manufacturer provides detailed installation instructions which should be followed carefully. The same straight pipe approach and flow straightening vanes to prevent spiral flow that the manufacturer uses during calibration must be reproduced in field installations. Straightening vanes, at least several pipe diameters long, should be placed in the straight pipeline an appreciable distance upstream from the meter as specified by the manufacturer.

Propeller shafts are usually designed to rotate in one or more bearings. Bearings are contained in a hub, where they are protected from direct contact with objects in the flow. However, water often can and does enter the bearing. Some hubs trap sediment or other foreign particles. After these particles work into the bearing, a definite added resistance to turning becomes apparent. Some propellers are, therefore, designed for flow-through cleaning action so that particles do not permanently lodge and partially consolidate in the bearings. However, some of these bearing flushing systems have been plugged when the bearings have become fully packed with sediment. Newer propeller meters generally have sealed or ceramic bearings to minimize sediment wear problems.

Although propellers are designed to pass (to some degree) weeds, moss, and other debris, only a limited amount of foreign material that can be tolerated in the flow. Even moderate amounts of floating moss or weeds can foul a propeller unless it is protected by screens. With larger amounts or certain kinds of foreign material in the water, even screens may not solve the problem. Heavy objects in the water can damage propellers. Where rodents, such as muskrats, can get to plastic propellers, they have been known to cause chewing damage.

Propeller meters require continuous inspection and maintenance, which may amount to very little to very much, depending on local conditions and brands selected. Potential users should seek information from other local users before selection. In some cases of high maintenance costs and expensive water, these meters have paid for themselves in as little as 2 months on the basis of water conserved. However, in other areas where water is relatively plentiful, they have never repaid their original cost. Propeller bearing troubles are the most expensive and common problem and may be difficult to overcome except by means of a well-planned maintenance program. Maintenance costs can be excessive if meters are used for water with sediment. Propeller meters require a maintenance routine where bearings are replaced based on time of operation.

5. Bypass Meters

These meters measure part of the total flow which is allowed or forced through a small passageway by differential pressure across a fitting and returned to the main flow. Thus, these meters are sometimes called proportional, or shunt, flowmeters. The side flow drives an indicator or small water measuring device such as a propeller, vane, rotameter, or turbine meter. Indicators of the smaller flowmeter readings are related to total discharge by calibration. These reading devices display or indicate instantaneous rate of flow, totalized volume of flow, or both. Bypass meters are produced and sold commercially with calibrations and discharge tables.

6. Magnetic Flowmeters

The operation of magnetic flowmeters is based upon the principle that a voltage is induced in an electrical conductor moving through a magnetic field. In the case of magnetic flowmeters, the conductor is the flowing water being measured. For a given field strength, the magnitude of the induced voltage is proportional to the velocity of the conductor.

The meter consists of a nonmagnetic and non-electrical conducting tube or pipe through which the water flows. Two magnetic coils are used, one on each side of the pipe. Two electrodes in each side of the insulated pipe wall sense the flow-induced voltage.

The meter should be mounted so that the electrodes are horizontal to prevent air from breaking the voltage measuring circuit. The meter has electrical circuits to transform the induced voltage into a rate-of-flow indication on a meter dial (figure 14-8). The electrical sensing system and uniform flow-through passage allow the magnetic flowmeter to measure flow in both directions.

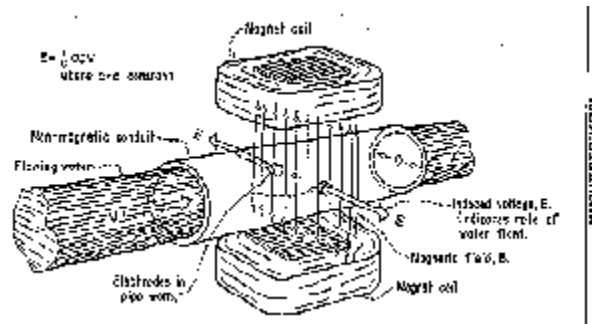


Figure 14-8 -- Schematic view of a magnetic flowmeter.

A source of electrical power is needed to activate the magnetic field, and a transmitter is used to record or send the rate-of-flow signals to desired stations. The water needs sufficient conductivity, but other properties such as temperature, viscosity, density, or solid particles do not change calibration. However, dissolved chemicals can deposit on the electrodes and cause accuracy errors. Some of these meters are provided with wipers or electrolytic or ultrasonic electrode cleaners.

Head losses through the meter are negligible, and accuracy of measurement in the upper half of the meter's rated capability is usually good. Later model electromagnetic meters can have good accuracy (+/-1.0%) for a range of minimum to maximum discharge.

7. Deflection Meters

A deflection meter consists of a vane or plate that projects into the flow and a sensing element that measures the deflection caused by the force of the flow against the vane. These meters are sometimes called drag or target meters. They are usually calibrated to indicate the rate of flow in some desired unit of measure. Head losses through the meter are low to moderate, depending upon design. These meters have no pressure taps to plug. The meters are available commercially and are relatively simple. Their accuracy ranges from moderate to good.

8. Variable-Area Meters

In variable-area meters, the water flows vertically upward in a conically tapered tube in which area increases with height. The rate of flow is indicated by the height at which a shaped weight attains stable support from the flow in the tapered tube. Smaller versions are commonly called rotameters because many of the weights are sometimes vanned to rotate for stability in the tapered tube. The weights appear to float freely in the tapered tube. Thus, they are often called floats. When the tube is transparent, the position of the float can be observed directly against graduations on the tube.

Larger meters sometimes have a stem attached to the float, which is linked mechanically or magnetically to an indicator. Auxiliary recording and transmitting of discharge and totaled volume are sometimes incorporated into these meters.

These meters generally have few moving parts to wear or otherwise cause trouble, and the accuracy of the meters can be high. The head losses may be large. These meters have to be installed in a vertical position, making pipe fitting more difficult.

Web Resources

The listings here should not be construed as an endorsement or recommendation of a service or product by the Bureau of Reclamation, Agricultural Research Service, Natural Resource Conservation Service, or other participants of these web pages. These are provided only as a convenience to our web clients. The listing below were selected based on a manufacture statement that they can provide a device related to this chapter or section. To suggest new information for this page, go to the [Suggest-A-Link](#) web page.

ISA (Instrumentation Society of America, the international society for measurement and control)
[RP16.4: Nomenclature and Terminology for Extension-Type Variable Area Meters \(Rotameters\)-1960](#)

<http://www.isa.org/?template=Ecommerce/ProductDisplay.cfm&ProductID=2507>

Manufactures

FLW Southeast, Inc.
1343 Canton Road Suite D-1
Marietta, GA 30066
Phone: (770) 424-1731
Fax: (770) 424-9733
E-mail: flwse@flwsoutheast.com
Related web page: www.flwsoutheast.com

9. Vortex Flowmeter

The vortex generating flowmeter is based on the principle that obstructions placed in flows generate vortex shedding trails in the flow (White and McMurtrie, 1971). A properly shaped obstruction will produce stable vortices that reinforce or interact with each other on each side of the obstruction.

The shedding vortex oscillations are sensed in different ways such as by thermistors, pressure cells, or magnetically picking up the oscillation of a shuttle ball in a chamber that has each end connected to each side of the obstruction. The proper shape of the obstruction also produces an oscillation frequency that is proportional to velocity over a large range of flow.

Manufacturers cite advantages such as the possibility of no moving parts, calibration by dimensional tolerance limits to ± 1 percent, large discharge range, and adaptability to electronic digital counting. The meters can be made portable by installing the obstruction through the stuffing boxes.

10. Pitot Tube Velocity Measurements

The straight upstream tube shown on figure 14-9a, which is connected perpendicular and flush to the inside wall of the pipe so it does not sense any velocity force, is called a *piezometer*. Water rises in the piezometer to an elevation that only balances the pressure head in the conduit. A simple pitot tube is shown downstream on figure 14-9a. This open tube has a right-angle bend that is inserted into conduit flow with its horizontal leg pointed upstream and parallel to velocity. Water runs into the tube and rises into the vertical stem until its weight balances both the force of the pipeline pressure head, h_p , sometimes called *static head*, and the force of approach velocity that has been converted to velocity head, h_v , by stagnation at the tip. In this form, the pitot tube is sometimes called a **total head tube** because the water rises above the tip a height equal to the sum, H_t , of pressure head in the conduit plus velocity head.

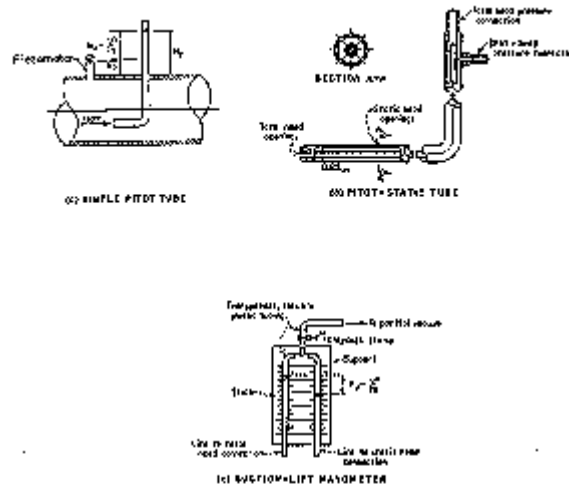


Figure 14-9.—Pitot tubes and manometer.

For a velocity measurement, the pressure head is subtracted from the total head, H_t , resulting in velocity head, h_v , or $V^2/2g$. Solving for the velocity of flow, V , results in:

$$V = C_d \sqrt{2gh_v} \quad (14-4)$$

where:

- V = velocity
- g = gravity constant
- h_v = measured velocity head
- C_d = coefficient

Figure 14-9 -- Pitot tubes and manometer.

For a velocity measurement, the pressure head is subtracted from the total head, H_t , resulting in velocity head, h_v , or $V^2/2g$. Solving for the velocity of flow, V , results in:

$$V = C_d \sqrt{2gh_v} \quad (14-4)$$

where:

- V = velocity
- g = gravity constant

h_v = measured velocity head

C = coefficient

For total head tubes that have reasonably long horizontal legs relative to tube diameter, the tube coefficient is commonly unity. However, pitot tubes with damaged tips, short tips, tube burrs, and short tips need calibration checks to determine correct tube coefficients that may deviate considerably from unity.

A more complex form of pitot tube is known as the *pitot-static tube*, which consists of the total head tube threaded through the center of a larger tube. Static ports are drilled perpendicular to and around the circumference of the horizontal part of the outer tube. Typical pitot-static tubes have static ports that are placed a distance of at least three outer tube diameters from the tip and at least eight diameters from the vertical leg of the outer tube (figure 14-9b). These distances protect the static ports from stem and tip disturbances, which would cause tube coefficients to deviate from unity.

Properly constructed and undamaged standard pitot-static tubes have a coefficient very close to unity and can be used without corrections for tube interference effects (ASME, 1983). Some special instruments have coefficients that differ considerably from unity. Appropriate coefficients should be applied as specified by manufacturers.

Manometers are commonly used to measure heads separately or differentially in a U-tube. The suction lift manometer shown in figure 14-9c uses an inverted U-tube with partial vacuum to lift the water surfaces up to the scale for reading the pressures where pipeline total head is insufficient to do so itself. The velocity head is obtained by subtracting the pressure head from the total head. More conveniently, a differential pressure cell that senses velocity head directly can be used. A recording digital voltmeter attached to the pressure cells can provide continuous records of velocity.

The rate of flow in pipelines under pressure may be computed from the conduit cross-sectional area and velocity observations made by pitot tubes or by commercial adaptations of pitot tubes (ASME, 1983; 1992). Reinforced pitometers have been used successfully in pipes up to 5 feet (ft) in diameter with flow velocities of 5 to 20 ft/s. Even large pipes can be traversed by having access ports on both sides of the pipe and probing to or past the conduit centerline from each side. The principal disadvantage encountered is that relatively large forces push on the tube when flow velocities are high, making positioning and securing of the instrument difficult. Dynamic instability may also occur, causing the tube to vibrate and produce erroneous readings. The flow measurements can be very accurate at moderate flow velocities.

11. Point Velocity Area Methods

Computing discharge point velocities for open channel flow is discussed in chapter 10. In conduits, several point velocities can be obtained by traversing with a velocity measuring device such as a pitot tube. Arrays of several velocity measuring devices, such as axial current meters, are sometimes fixed on racks that span the conduit to measure several velocities simultaneously. Some flowmeters directly measure average velocity along lines through the flow.

The measurement of point velocities is relatively simple. However, partitioning the flow section relative to velocity points is complex, depending on the accuracy desired. The main problem in determining proper partial areas is that each point velocity represents or determines meaningful velocity weighting factors related to each point location. Many schemes can be used to locate measuring points on grids or diameters and assign weighting factors for each position. The procedures are further complicated when corrections are needed to account for the obstruction of rack support systems and the size of the instruments themselves. If accuracies better than +/-3 percent are needed, then procedures set by codes such as ISO (1977) and ASME (1992) should be consulted.

Some methods of averaging velocity are done by selecting equal areas related to the shape of the flow cross section and measuring velocity at specific points within these areas. For pitot measurements, the average of the square root of the velocity heads of the point measurements is multiplied by the flow section area.

The most common pressure conduit is the circular pipe. For a constant rate of flow, the velocity varies from point to point across the stream, gradually increasing from the walls toward the center of the pipe. The mean velocity is obtained by dividing the cross-sectional area of the pipe into a number of concentric, equal area rings and a central circle. The standard (ASME, 1983) 10-point system is shown on figure 14-10a. More equal area divisions may be used if required by large flow distortions or other unusual flow conditions. Velocity measurements are taken at specific locations in these subareas (figure 14-10a) and are adjusted in terms of average velocity head by the equation:

$$v_{avg} = \sqrt{2g} (\sqrt{h_v})_{avg} \quad (14-5)$$

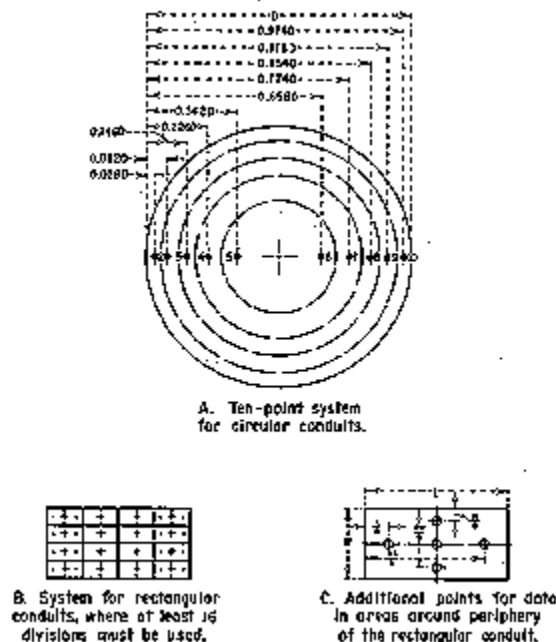


Figure 14-10 -- Locations for pitot tube measurements in circular and rectangular conduits (reproduced from British Standard 1042, Flow Measurement [1943], by permission of the British Standards Institution).

The mean velocity in rectangular ducts can be found by dividing the cross section into an even number (at least 16) of equal rectangles geometrically similar to the duct cross section and measuring the velocity at the center of each area ([figure 14-9b](#)). Additional readings should be taken in the areas along the periphery of the cross section according to the diagram on [figure 14-9c](#). Then, the average velocity is determined from equation 14-5.

Acoustic devices, discussed in chapter 11, measure accurate average velocity along chords or diametral lines in planes across the flow section. The diametral arrangement uses the simple average of the line velocities corrected for the angle of the plane across the conduit. The multiple chordal systems use a specific weighting factor for each line velocity to determine the average (AMSE, 1992). The chord locations are specified to maximize accuracy.

12. California Pipe Method

This method measures the discharge from the open end of partially filled horizontal pipes discharging freely into the air (Vanleer, 1922; 1924). This method is sometimes considered a trajectory method. However, the measurement is really based on the brink depth at the end of the pipe. This method can be adapted to the measurement of discharge in small open channels where the discharge can be diverted through a horizontal pipe flowing partially full and discharging freely into the air.

Figure 14-11 illustrates one pipe fitting arrangement to accommodate the California pipe discharge measurement. Other arrangements may be possible. With such an arrangement, the only measurements necessary are the inside diameter of the pipe and the vertical distance from the upper inside surface of the pipe to the surface of the flowing water at the outlet end of the pipe. With this information, the discharge may be computed by:

$$Q = 8.69 \left(1 - \frac{a}{d}\right)^{1.88} d^{2.48} \quad (14-6)$$

where:

Q = discharge (ft³/s)

a = distance measured in the plane of the end of the pipe from the top of the inside surface of the pipe to the water surface (ft)

d = internal diameter of the pipe (ft)

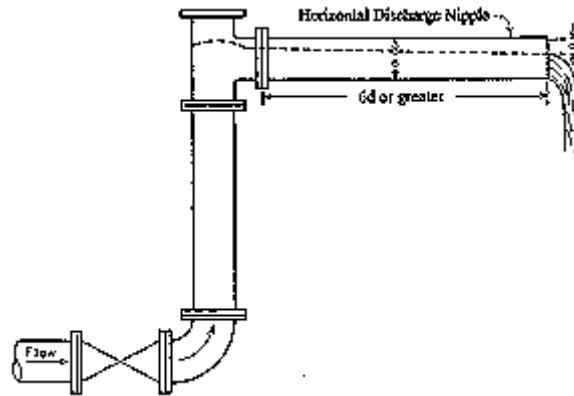


Figure 14-11 -- Typical arrangement for measuring flow by the California pipe method.

This equation, developed from experimental data for pipes 3 to 10 inches in diameter, gives reasonably accurate values of discharge for that range of sizes under certain flow conditions. However, tests by the Natural Resources Conservation Service (formerly U.S. Soil Conservation Service) (Rohwer, 1943) showed that for depths greater than about one-half the diameter of the pipe or a/d less than about 0.5, the discharge does not follow the Vanleer equation. Bos (1989) shows that brink depth must be less than $0.55d$, or a/d must be greater than 0.45. Care should therefore be taken in using equation 14-6. The discharge uncertainty of this method is expected to be about ± 10 percent, assuming careful brink depth and pipe diameter measurements.

Some additional requirements for proper use and for attaining potential accuracy of the California pipe measurement method are:

- (1) The discharge pipe must be level.
- (2) The pipe must be partially full with a/d greater than 0.45.
- (3) The flow must discharge freely into the air.

13. Trajectory Methods

Basically, trajectory methods consist of measuring the horizontal and vertical coordinates of a point in the jet issuing from the end of a pipe (Stock, 1955). The pipe may be oriented either vertically or horizontally. The principal difficulty with this method is in measuring the coordinates of the flowing stream accurately.

(a) Vertical Pipes

Lawrence and Braunworth (1906) noted that two kinds of flow occur from the end of vertical pipes. With a small rise of water (up to $0.37d$) above the end of the pipe, the flow acts like a circular weir. When the water rises more than $1.4d$, jet flow occurs. When the rise is between these values, the mode of flow is in transition. Lawrence and Braunworth (1906) determined that when the height of the jet exceeded $1.4d$, as determined by sighting over the jet to obtain the maximum rise, the discharge is given by:

$$Q = 5.01d^{1.99}h^{0.53} \quad (14-7)$$

where:

Q = rate of flow, gal/min
 d = inside diameter of the pipe, in
 h = height of jet, in

When the rise of water above the end of the pipe is less than $0.37d$, discharge is given by:

$$Q = 6.17d^{1.25}h^{1.35} \quad (14-8)$$

For jet heights between $0.37d$ and $1.4d$, the flow is considerably less than that given by either of these equations. Figure 14-12, prepared using data from Stock (1955) gives flow rates in gallons per minute for standard pipes 2 to 12 inches in diameter and jet heights from 12 to 60 in. Bos (1989) assigns to this method an accuracy of +/-10 percent for the jet flow range to +/-15 percent for the weir flow range.

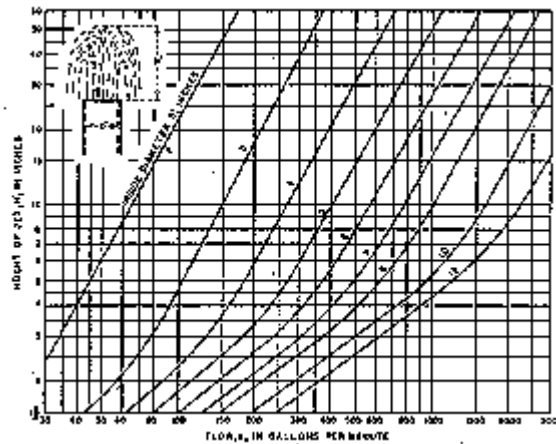


Figure 14-12 -- Discharge curves for measurement of flow from vertical standard pipes. The curves are based on data from experiments of Lawrence and Braunworth, American Society of Civil Engineers, Transactions, Vol. 57, 1906 (courtesy of Utah State University).

For irrigation convenience, the Natural Resources Conservation Service produced a table from curves for vertical pipes in Stock (1955) for the NRCS *National Engineering Handbook* (1962a). This table is reproduced here as table 14-1. The table gives discharges for different heads up to 40 in for standard nominal pipe diameters from 2 to 12 inches and for outside diameters of well casings from 4 to 12 inches. As mentioned before, accuracies better than 15 and 10 per-cent should not be expected, depending on whether the flow is acting as a weir or jet-type flow.

Table 14-1 -- Flow from vertical pipes¹

Jet height (inches)	Diameter of pipe (inches)							
	2	3	4	5	6	8	10	12
	50.8	76.2	101.6	127.0	152.4	203.2	254.0	304.8
2	28	57	75	93	111	147	170	200
2 1/2	31	63	82	101	120	157	181	212
3	34	69	90	110	130	168	193	226
3 1/2	37	75	98	119	139	178	204	239
4	40	81	106	128	148	188	215	252
4 1/2	43	88	114	137	157	198	226	265
5	46	95	124	147	167	209	238	277
6	50	104	136	160	180	223	253	299
7	54	115	150	175	195	241	272	322
8	58	127	166	193	213	253	285	346
9	62	140	184	213	233	277	310	371
10	66	154	204	234	254	293	327	397
12	74	181	241	281	301	341	371	451
14	82	209	281	321	341	381	411	501
16	90	239	321	361	381	421	451	551
18	99	271	361	401	421	461	491	601
20	108	304	401	441	461	501	531	651
25	137	390	490	540	560	610	640	780

¹ Table prepared from discharge curves in Utah Engineering Experimental Station, Bulletin 5, "Measurement of Irrigation Water," June 1955.
² Standard pipe.
³ Outside diameter of well casing.

¹ Table prepared from discharge curves in Utah Engineering Experimental Station, Bulletin 5, "Measurement of Irrigation Water," June 1955.

² Standard pipe.

³ Outside diameter of well casing.

(b) Horizontal Pipes

When brink depths are greater than $0.5D$, the more general Purdue pipe method developed by Greve (1928) should be used, rather than the California pipe method. The Purdue method applies equally well to both partially and completely filled pipes. The Purdue method consists of measuring coordinates of the upper surface of the jet as shown on figure 14-13. If the water in the pipe is flowing at a depth of less than $0.8D$ at the outlet, the vertical distance, Y , can be measured at the end of the pipe where $X = 0$. For higher rates of flow, Y may be measured at horizontal distances, X , from the pipe exit of 6, 12, or 18 in. Flow values in gallons per minute for 2- to 6-in-diameter standard pipes are shown in graphs on figure 14-14 (Stock, 1955).

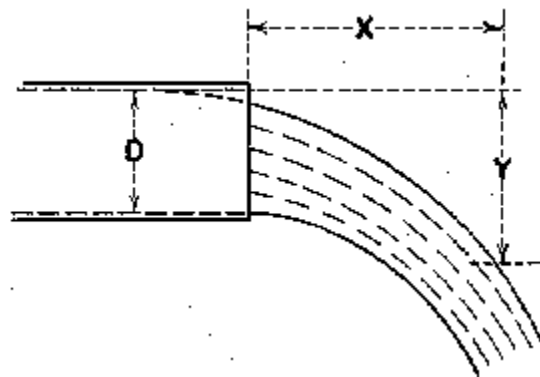


Figure 14-13 -- Purdue method of measuring flow from a horizontal pipe (courtesy of Utah State University).

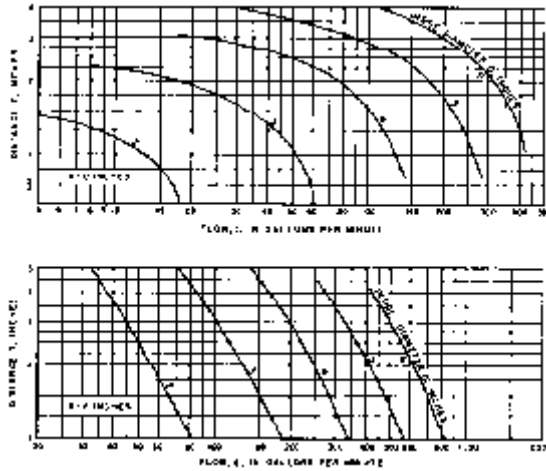


Figure 14-14 -- Flow from horizontal standard pipes by Purdue coordinate method (courtesy of Utah State University) (sheet 1 of 2).

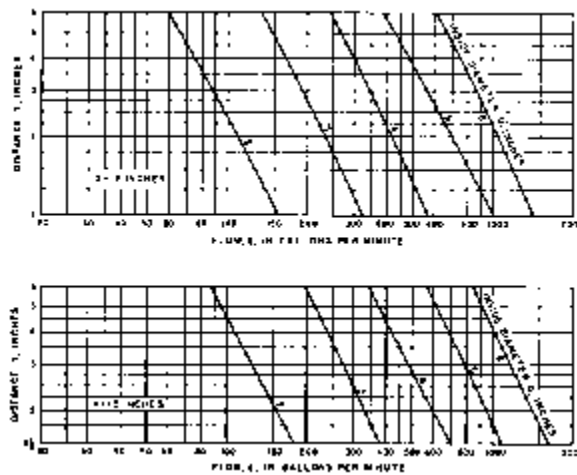


Figure 14-14 -- Flow from horizontal standard pipes by Purdue coordinate method (courtesy of Utah State University) (sheet 2 of 2).

The most accurate results will be obtained when the pipe is truly horizontal. If it slopes upward, the indicated discharge will be too high. If it slopes downward, the indicated discharge will be too low.

Difficulty occurs in making the vertical measurement, Y , because the top of the jet will usually not be smooth and well defined.

The NRCS produced table 14-2 for horizontal pipe discharge for X of 0, 6, 12 and 18 in and Y up to about 8 in for pipe diameters from 2 to 6 in. As mentioned previously, accuracies better than 10 percent should not be expected.

Table 14-2 Flow from horizontal pipes¹

Y (inches)	WHEN X=1/2 Size of pipe (nominal diameter)					
	2 inch	3 inch	4 inch	5 inch	6 inch	
	Q, cfm	Q, cfm	Q, cfm	Q, cfm	Q, cfm	Q, cfm
0.20		47.7	130	308		
.30		66.5	175	393		530
.40		85.3	231	518		718
.50		104.1	298	673		944
.60	4.7	122.9	375	858		1144
.70	7.9	141.7	463	1072		1424
.80	11.1	160.5	561	1315		1744
.90	14.3	179.3	669	1587		2104
1.00	17.5	198.1	787	1888		2504
1.20	27.1	253.7	1021	2447		3264
1.40	36.7	309.3	1255	3006		4024
1.60		364.9	1489	3565		4784
1.80		420.5	1723	4124		5544
2.00		476.1	1957	4683		6304
2.20		531.7	2191	5242		7064
2.40		587.3	2425	5801		7824
2.60		642.9	2659	6360		8584
2.80		698.5	2893	6919		9344
3.00		754.1	3127	7478		10104
3.20		809.7	3361	8037		10864
3.40		865.3	3595	8596		11624
3.60		920.9	3829	9155		12384
3.80		976.5	4063	9714		13144
4.00		1032.1	4297	10273		13904
4.20		1087.7	4531	10832		14664
4.40		1143.3	4765	11391		15424
4.60		1198.9	5000	11950		16184
4.80		1254.5	5234	12509		16944

Y (feet)	WHEN X=3 INCHES Size of pipe (nominal diameter)				
	2 inch	3 inch	4 inch	5 inch	6 inch
	Q, cfm	Q, cfm	Q, cfm	Q, cfm	Q, cfm
1.24	137	170	213	256	299
1.36	146	174	217	260	303
1.48	155	178	221	264	307
1.60	164	182	225	268	311
1.72	173	186	229	272	315
1.84	182	190	233	276	319
1.96	191	194	237	280	323
2.08	200	198	241	284	327
2.20	209	202	245	288	331
2.32	218	206	249	292	335
2.44	227	210	253	296	339
2.56	236	214	257	300	343
2.68	245	218	261	304	347
2.80	254	222	265	308	351
2.92	263	226	269	312	355
3.04	272	230	273	316	359
3.16	281	234	277	320	363
3.28	290	238	281	324	367
3.40	299	242	285	328	371
3.52	308	246	289	332	375
3.64	317	250	293	336	379
3.76	326	254	297	340	383
3.88	335	258	301	344	387
4.00	344	262	305	348	391
4.12	353	266	309	352	395
4.24	362	270	313	356	399
4.36	371	274	317	360	403
4.48	380	278	321	364	407
4.60	389	282	325	368	411
4.72	398	286	329	372	415
4.84	407	290	333	376	419
4.96	416	294	337	380	423
5.08	425	298	341	384	427
5.20	434	302	345	388	431
5.32	443	306	349	392	435
5.44	452	310	353	396	439
5.56	461	314	357	400	443
5.68	470	318	361	404	447
5.80	479	322	365	408	451
5.92	488	326	369	412	455
6.04	497	330	373	416	459
6.16	506	334	377	420	463
6.28	515	338	381	424	467
6.40	524	342	385	428	471
6.52	533	346	389	432	475
6.64	542	350	393	436	479
6.76	551	354	397	440	483
6.88	560	358	401	444	487
7.00	569	362	405	448	491
7.12	578	366	409	452	495
7.24	587	370	413	456	499
7.36	596	374	417	460	503
7.48	605	378	421	464	507
7.60	614	382	425	468	511
7.72	623	386	429	472	515
7.84	632	390	433	476	519
7.96	641	394	437	480	523
8.08	650	398	441	484	527
8.20	659	402	445	488	531
8.32	668	406	449	492	535
8.44	677	410	453	496	539
8.56	686	414	457	500	543
8.68	695	418	461	504	547
8.80	704	422	465	508	551
8.92	713	426	469	512	555
9.04	722	430	473	516	559
9.16	731	434	477	520	563
9.28	740	438	481	524	567
9.40	749	442	485	528	571
9.52	758	446	489	532	575
9.64	767	450	493	536	579
9.76	776	454	497	540	583
9.88	785	458	501	544	587
10.00	794	462	505	548	591

Table 14-2 Flow from horizontal pipes¹ (continued)

Y (feet)	WHEN X=12 INCHES Size of pipe (nominal diameter)				
	2 inch	3 inch	4 inch	5 inch	6 inch
	Q, cfm	Q, cfm	Q, cfm	Q, cfm	Q, cfm
.36	137	140	143	146	149
.48	145	148	151	154	157
.60	153	156	159	162	165
.72	161	164	167	170	173
.84	169	172	175	178	181
.96	177	180	183	186	189
1.08	185	188	191	194	197
1.20	193	196	199	202	205
1.32	201	204	207	210	213
1.44	209	212	215	218	221
1.56	217	220	223	226	229
1.68	225	228	231	234	237
1.80	233	236	239	242	245
1.92	241	244	247	250	253
2.04	249	252	255	258	261
2.16	257	260	263	266	269
2.28	265	268	271	274	277
2.40	273	276	279	282	285
2.52	281	284	287	290	293
2.64	289	292	295	298	301
2.76	297	300	303	306	309
2.88	305	308	311	314	317
3.00	313	316	319	322	325
3.12	321	324	327	330	333
3.24	329	332	335	338	341
3.36	337	340	343	346	349
3.48	345	348	351	354	357
3.60	353	356	359	362	365
3.72	361	364	367	370	373
3.84	369	372	375	378	381
3.96	377	380	383	386	389
4.08	385	388	391	394	397
4.20	393	396	399	402	405
4.32	401	404	407	410	413
4.44	409	412	415	418	421
4.56	417	420	423	426	429
4.68	425	428	431	434	437
4.80	433	436	439	442	445
4.92	441	444	447	450	453
5.04	449	452	455	458	461
5.16	457	460	463	466	469
5.28	465	468	471	474	477
5.40	473	476	479	482	485
5.52	481	484	487	490	493
5.64	489	492	495	498	501
5.76	497	500	503	506	509
5.88	505	508	511	514	517
6.00	513	516	519	522	525
6.12	521	524	527	530	533
6.24	529	532	535	538	541
6.36	537	540	543	546	549
6.48	545	548	551	554	557
6.60	553	556	559	562	565
6.72	561	564	567	570	573
6.84	569	572	575	578	581
6.96	577	580	583	586	589
7.08	585	588	591	594	597
7.20	593	596	599	602	605
7.32	601	604	607	610	613
7.44	609	612	615	618	621
7.56	617	620	623	626	629
7.68	625	628	631	634	637
7.80	633	636	639	642	645
7.92	641	644	647	650	653
8.04	649	652	655	658	661
8.16	657	660	663	666	669
8.28	665	668	671	674	677
8.40	673	676	679	682	685
8.52	681	684	687	690	693
8.64	689	692	695	698	701
8.76	697	700	703	706	709
8.88	705	708	711	714	717
9.00	713	716	719	722	725
9.12	721	724	727	730	733
9.24	729	732	735	738	741
9.36	737	740	743	746	749
9.48	745	748	751	754	757
9.60	753	756	759	762	765
9.72	761	764	767	770	773
9.84	769	772	775	778	781
9.96	777	780	783	786	789
10.08	785	788	791	794	797
10.20	793	796	799	802	805
10.32	801	804	807	810	813
10.44	809	812	815	818	821
10.56	817	820	823	826	829
10.68	825	828	831	834	837
10.80	833	836	839	842	845
10.92	841	844	847	850	853
11.04	849	852	855	858	861
11.16	857	860	863	866	869
11.28	865	868	871	874	877
11.40	873	876	879	882	885
11.52	881	884	887	890	893
11.64	889	892	895	898	901
11.76	897	900	903	906	909
11.88	905	908	911	914	917
12.00	913	916	919	922	925

¹ Table for standard steel pipe prepared from data resulting from actual experiments conducted at Purdue University Experimental Station, Bulletin 32, "Measurement of Pipe Flow by the Coordinate Method," Aug. 1926.

¹ Table for standard steel pipe prepared from data resulting from actual experiments conducted at Purdue University Experimental Station, Bulletin 32, "Measurement of Pipe Flow by the Coordinate Method," August 1928.

14. Small Tubes or Siphons

Plastic or aluminum siphons and tubes are commonly used to deliver water from a canal or ditch to the furrows (figure 14-15) (Scott and Houston, 1959). These conduits may also be used to measure the rate of flow. The head acting on siphons and straight pipes through banks is measured in the manner shown on figure 14-15. The rate of flow from figure 14-16 is used only for siphons and pipes where the flow exits the tube into free air. Figure 14-17 is used only for the submerged exit case. The uncertainty for discharge is about +/-15 percent. Therefore, this method of determining discharge is approximate but could be useful for managing water allotments and apportionment over acreage.

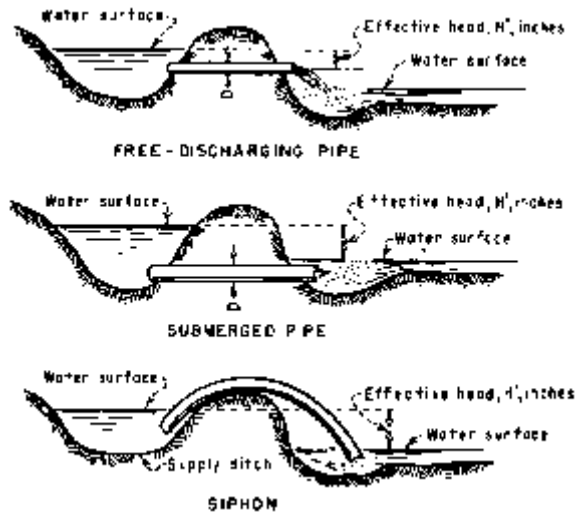


Figure 14-15 -- Discharge through ditch-to-furrow pipes and siphons (figures 14-16 and 14-17) may be determined by measuring the effective head.

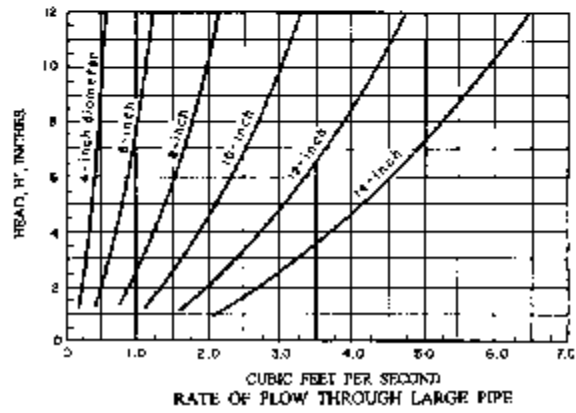
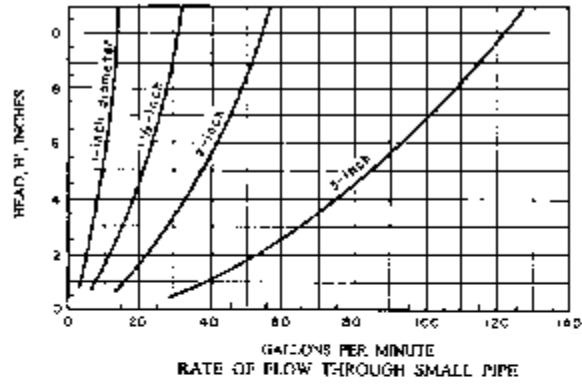


Figure 14-16 -- Rates of flow through ditch-to-furrow pipes for various heads.

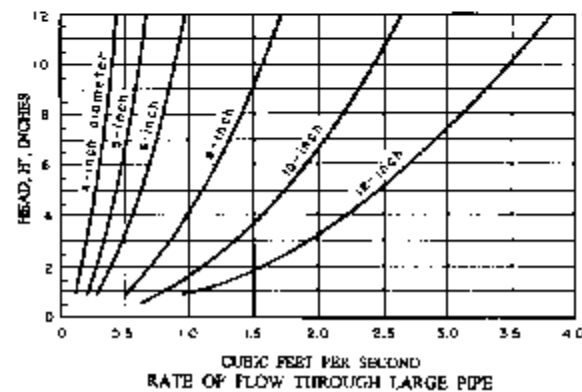
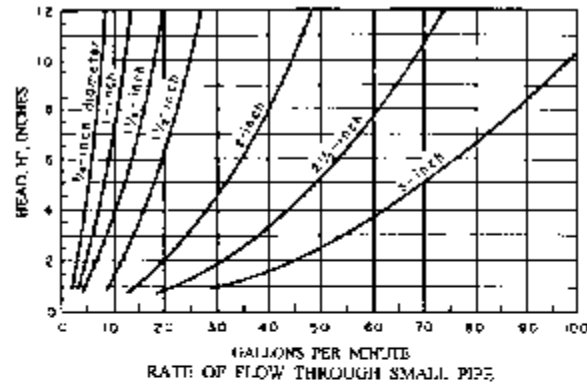


Figure 14-17 -- Rates of flow through ditch-to-furrow siphons

for various heads.

The pipe ends should be cut cleanly with no burrs. The tubes and ends should not be dented or deformed. Tight bends should be avoided. The flow past either end of the tube must be slow compared to tube velocity. Tubes can become partially or fully air locked at lower discharges of curves shown on figures 14-16 and 14-17. The siphons should be reprimed periodically when operating at the low discharge region. Both submerged ends should be located a distance of 1.5 diameters from channel flow boundaries and water surface. If a vortex forms over the siphon entrance, the entrance should be lowered if possible; otherwise, the vortex should be suppressed. The vortex can be suppressed by rafting a wide board over the intake and hanging additional cross vanes from the board if needed. Bos (1989) gives more details concerning these requirements and provides rating curves in metric units.

Figure 14-18 (NRCS, 1962a) gives discharge in gallons per minute for heads up to 20 inches for siphon lengths common to furrow irrigation with pipe diameters from 2 to 6 inches. As mentioned previously, accuracies better than 10 percent should not be expected.

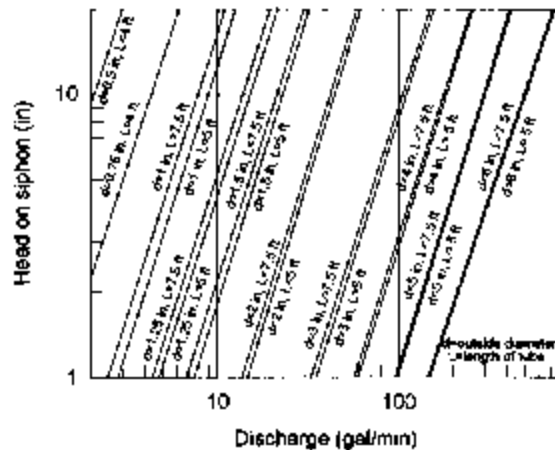


Figure 14-18 -- Discharge of aluminum or plastic siphon tubes at various heads for different tube lengths.

15. The Pressure-Time Method

The pressure-time data recorded during downstream closure of valves, wicket gates, or other devices can be used to calculate discharge (Gibson, 1923). Gibson developed elaborate equipment and detailed computational procedures for determining discharge. Modern pressure cells, electronic computers, and recording equipment have made the technique easier to accomplish. Codes such as those published by the ASME (1992) have been established for turbines. The pressure conduit should be at least 25 ft long, preferably longer.

Discharge is computed from:

- (1) Pressure-time recording taken while the valve or other control device is closing.
- (2) The cross-sectional area of the conduit.
- (3) The length from control device to the entrance.

This method has recently been applied to shorter, low head turbines (Almquist et al., 1994). The pressure variation is automatically recorded with respect to time on equipment especially devised for this method. Use of the Gibson method requires specially trained personnel. Patents restricting the use of the equipment and method have expired.

16. Calibration of Turbines, Pumps, Gates, and Valves

Some irrigation distribution systems may require measurement of the flow by means of the turbines, pumps, gates, or valves through which the water flows. This measurement may be done if the structure is calibrated in the field using an approved flow measuring method or in the laboratory using hydraulic models. Properly prepared calibration curves are a reliable means for obtaining accurate discharge measurements.

Discharge is generally related to power in the case of turbines or pumps. The relationships may be determined by measuring the average power output or input during the period in which discharge measurements are made for various load conditions. Curves or tables are developed from these test data to show the rate of flow that occurs for specific power and operation conditions. Long- or short-term deterioration or damage may change machinery efficiency. Thus, these calibrations should be periodically checked, adjusted, and recalibrated as needed.

For gates and valves, discharge-versus-gate-opening curves for various appropriate heads are desired. These curves may be determined by measuring the rates of flow at given gate or valve openings under specific head conditions. By operating over the full range of openings and heads, data may be obtained for establishing the families of curves. Generally, the curves would show the rates of flow in cubic feet per second (ft^3/s) that occur through the gate or valve at specific openings, which are expressed in percent of opening, for the pertinent operating heads. These curves may also be prepared from model test data.

17. Acoustic Flowmeters

The most recent advances in measuring flow in pressure conduits has been with the further developments of acoustic flowmeters. This class of meters is covered in detail in chapter 11 of this manual. These meters are used extensively at powerplants and other major points of diversion. They are well suited to use in automated data acquisition systems. Their accuracy depends on type and installation, but generally varies from ± 3 percent down to ± 0.1 percent.

18. Bibliography

Almquist, C.W., D.B. Hansen, and P.A. March, Pressure-Time Flow Rate in Low Head Hydro," Proceedings, Symposium on Fundamentals and Advancements in Hydraulic Measurements and Experimentation, Buffalo NY, 1994.

American Society of Mechanical Engineers, *Fluid Meters, Their Theory and Application*, H.S. Bean, editor, sixth edition revised, Research Committee on Fluid Meters, New York, 1983.

American Society of Mechanical Engineers, "Performance Test Codes-Hydraulic Turbines and Turbine Mode of Pump/Turbines," revision, Performance Test Code 18, New York NY, 1992.

Bos, M.G., *Discharge Measurement Structures*, ILRI Publication 20, Third Revised Edition, Wageningen, The Netherlands, 1989.

British Standards Institution, B.S. 1042, *Flow Measurement*, 1943. Dijkstra, H.H., "Gas Meters," In: *Developments In Flow*

Measurement, R.W.W. Scott (editor), 1982, chapter 5, pp. 129-170, Applied Science Publishers, London. 333 p., 1982.

Furness, R.A., "Developments in Pipeline Instrumentation," in *Measurement and Control*, No. 20, pp. 25-28, 1987.

Gibson, N.R., "The Gibson Method and Apparatus for Measuring the Flow of Water in Closed Conduits," In: *Transactions of the American Society of Mechanical Engineers*, vol. 45, p. 343, 1923.

Greve, F.W., "Measuring of Pipe Flow by the Coordinate Method," Purdue Engineering Experiment Station, Bulletin 32, 1928.

Hobbs, M., "Inside the Orifice Plate," *Process Engineering*, London, vol. 68(2), pp. 33, 35, 1987.

Humphreys, J.S., "Improving the Performance of Those Orifice Plates," *Process Engineering* (London), vol. 68(2), pp. 37, 39, 41, 1987.

International Organization for Standardization, *Measurement of Fluid Flow in Closed Conduits: Velocity Area Method Using Pitot Tubes*, ISO 3966, First Edition, Zurich, Switzerland, 1977.

International Organization for Standardization, *Measurement of Fluid Flow in Closed Conduits: Velocity Area Method Using Pitot Tubes*, ISO 5167-1, 1991.

Lawrence, F.E., and P.L. Braunworth, "Fountain Flow of Water in Vertical Pipes," In: *Transactions of the American Society of Civil Engineers*, vol. 57, pp. 265-306, 1906.

Natural Resources Conservation Service, *National Engineering Handbook*, Part 623, Section 15 (pipe coordinates), Chapter 9, "Measurement of Irrigation Water," 1962a.

Natural Resources Conservation Service, *National Engineering Handbook*, Part 623, Section 15, Chapter 5, "Furrow Irrigation," 1962b.

Replogle, J.A., and B.T. Wahlin, "Venturi Meter Construction for Plastic Irrigation Pipelines," *Proceedings, Applied Engineering in Agriculture*, American Society of Agricultural Engineers, 10(1):21-26, 1994.

Rohwer, C., "Discharge of Pipes Flowing Partly Full," *Civil Engineering*, American Society of Civil Engineers, 1943.

Scott, V.E., and C.E. Houston, "Measuring Irrigation Water," Circular 473, California Agricultural Experiment Station, University of California, 1959.

Streeter, V.L., *Fluid Mechanics*, McGraw-Hill, New York NY, 1951.

Stock, E.M., "Measuring of Irrigation Water," Bulletin No. 5, Utah

State Engineering Experiment Station and Utah Cooperative Extension Service, 1955.

Summers, J.B., "Flow Characteristics of 8-, 10-, 12-, and 18-Inch Concrete Fresno Irrigation Meters," Hydraulic Laboratory Report No. HYD-340, Bureau of Reclamation, Denver CO, 1952.

Summers, J.B., "Hydraulic Investigations of the Consolidated Irrigation District Venturi-Type Meters," Hydraulic Laboratory Report No. HYD-341, Bureau of Reclamation, Denver CO, 1953.

Vanleer, B.R., "The California Pipe Method of Water Measurement," *Engineering News Record*, August 3, 1922, and August 21, 1924.

White, R., and McMurtrie, "The Vortex Shedding Flowmeter," Paper 2-16-187, *Synposium on Flow-Its Measurement and Control in Science and Industry*, 1971.

Elbow Flow Meters

Clifford A. Pugh, Water Resources Research Laboratory

Elbow meters are based on the principle of "conservation of momentum." Momentum conservation requires that the momentum flux (momentum per unit time) remain unchanged as steady flow occurs through an isolated system of fluid. Since momentum is a vector quantity, a change in direction of the flow causes a reduction of momentum in the original direction which is offset by an increase in the new direction. In an elbow, such as the mitred elbow shown in figure 1, the momentum in the horizontal direction is changed by the pipe turning down. This change in direction causes the flow to exert a force on the pipe elbow.

$$F = \rho Q (V_2 - V_1) \quad [\text{Momentum Equation}] \quad (1)$$

Where,

F = Force

ρ = the fluid density

Q = the discharge (flow)

V = the velocity vector

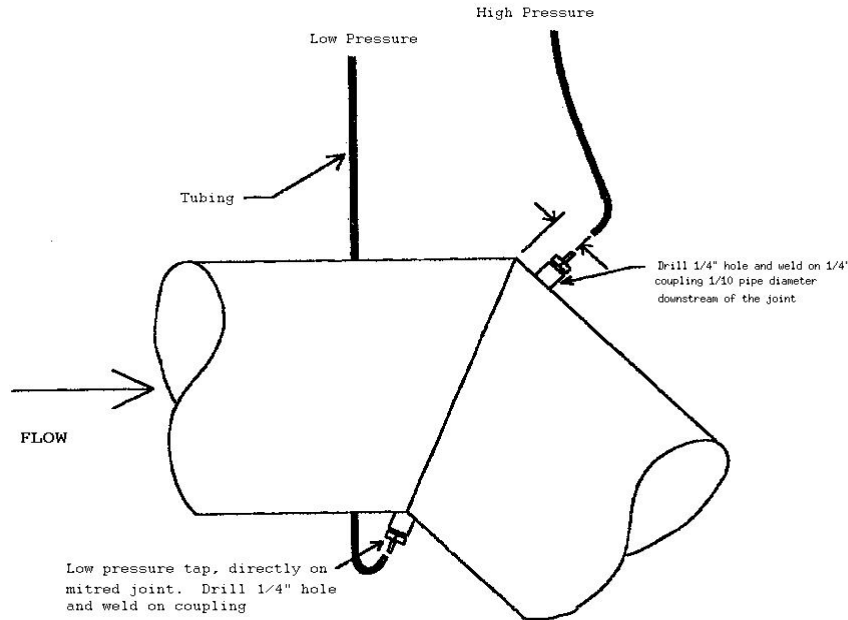


Figure 1 - Forty-five degree mitred bend with pressure taps on the inside and outside of the bend. The pressure differential is related to the square of the velocity.

This force results in an increased pressure on the outside of the bend and a decreased pressure on the inside. The pressure difference is proportional to the square of the velocity. The general form of the equation would be :

$$Q = C_d A \sqrt{2g\Delta h} \quad (2)$$

Figure 1 shows recommended pressure tap locations for a mitred bend according to ID Tech, inc. ID Tech sells an "Electronic Flow Calculator" based on an elbow meter. The coefficients of discharge (C_d) for mitred bends (determined empirically by ID Tech) are proprietary. Their toll free phone number is 888-782-0498.

Figure 2 shows a multiple level outlet at Beltzville Dam in Pennsylvania. Differential pressures across opposing pressure taps (P1 and P2) and stream gage measurements were used to develop the rating curve and equation shown in figure 3 (Hart and Pugh, 1975).

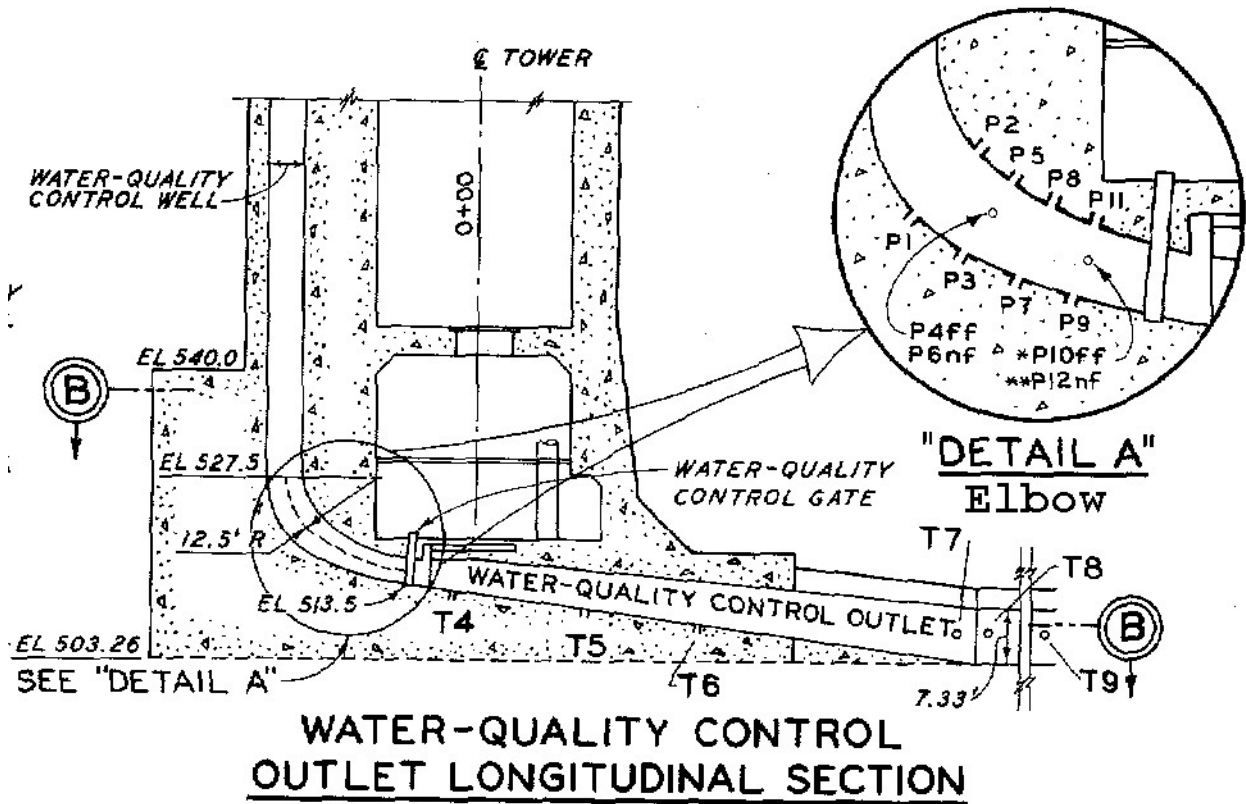
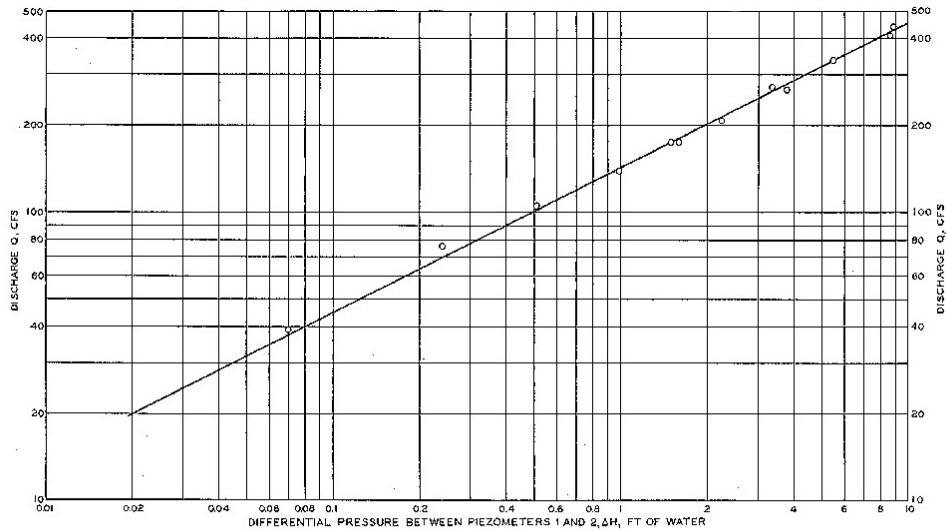


Figure 2 - Water Quality Control outlet at Beltzville Dam (Hart and Pugh, 1975). The pressure differential between P1 and P2 was empirically calibrated to obtain a discharge relationship. The elbow meter is used to set desired outlet flows for normal operations.



EQUATION: $Q = 141.4 \sqrt{\Delta H}$

**ELBOW METER CALIBRATION
DIFFERENTIAL PRESSURE BETWEEN
PIEZOMETERS 1 AND 2
vrs. DISCHARGE**

Figure 3 - Elbow Meter Calibration, Beltzville Dam.

Similar empirical relationships could be developed for pipe bends in the field by using a strap on acoustic flowmeter (or another flow measurement method) to obtain the data and develop the equation. One differential pressure transducer would be connected to the high and low pressure taps to measure the differential and obtain flow. This is a simple and relatively accurate device if the pressure taps are properly installed and the "burrs" are cleaned from the inside of the tap. A slight rounding of the edge of the taps helps to improve their performance.

As a practical matter, the lower limit of an elbow meter is about 2 ft/s. Pressure differences and discharge measurement accuracy are very low below this velocity.

Flow Tech recommends an upper velocity limit of 10 ft/s, this is probably due to separation at the sharp bend in the mitred elbow. Higher velocities may be allowable for

elbows with a constant radius such as the example in figure 2 and 3.

(1) Hart, E. D., and Pugh, C. A. , "Outlet Works for Beltzville Dam, Pohopoco Creek, Pennsylvania," Technical Report H-75-10, U. S. Army Corps of Engineers, Waterways Experiment Station, May, 1975.

Nomenclature

A	flow section area
A_c	contracted area of flow
A_o	orifice area
a	area
B	average width
b_c	width
C	Chezy factor, general coefficient, concentration of a tracer, or constant
C_a	gate angle correction factor
C_c	contraction coefficient
C_d	discharge coefficient
C_e	effective discharge coefficient
C_v	velocity of approach coefficient
C_{va}	coefficient to account for exclusion of approach velocity head
C_{vf}	velocity coefficient caused by friction loss
c	velocity of sound
D	pipe diameter
d_v	distance water will travel at a given velocity in a pipe of constant diameter
E	specific energy
$E_{\%QCs}$	error in percent comparison standard discharge
$E_{\%QFS}$	error in percent full-scale discharge
e	a subscript denoting "effective"
egl	energy grade line
F	Froude number

F_b	canal freeboard
F_c	critical Froude number
F_p	pressure force
f	friction factor
G_o	gate opening
g	acceleration caused by gravity
H	total energy head
H_c	critical total energy head
h	head or height
h_a	measuring head
h_b	submergence head
h_b/h_a	submergence ratio
h_c	critical head
h_{cm}	critical hydraulic mean depth
h_e	effective measurement head
h_f	head loss
h_m	hydraulic mean depth
h_v	measured velocity head
h_{1e}	$h_1 + k_h$
h_1	head measure above a weir crest (upstream head)
Δh	upstream head minus downstream head (differential head)
$h_{f(1-2)}$	friction head loss between two stations
hgl	hydraulic grade line
K	constant

k	boundary roughness size
k_b	correction factor to obtain effective weir length
k_h	correction factor to obtain effective head
L	length
L_b	cross-sectional width
L_e	$L + k_b$ or effective crest length
N	sample number
n	friction or roughness factor
PH	pinion height
P_w	wetted perimeter
p	pressure or height of crest above approach invert
Q	discharge
Q_a	actual discharge
Q_c	critical discharge
Q_{cs}	comparison standard discharge
Q_s	suppressed orifice discharge
Q_{eq}	discharge computed using measured heads and the regression equation
Q_{FS}	full scale or maximum discharge
Q_{ind}	indicated discharge from device output
Q_{max}	maximum discharge
Q_{min}	minimum discharge
Q_t	theoretical discharge through an orifice
$\Delta Q\%$	percent deviation of discharge
q	unit or partial discharge

Re	Reynolds number
R_h	hydraulic radius
r	ratio of suppressed portion of the perimeter of an orifice to total perimeter
r	radius of curvature
S	slope or estimate of standard deviation
S_o	invert or bottom slope
S_{ws}	water surface slope
s	estimate of standard deviation
T	time
T	top water surface width
T_c	top water surface width at critical conditions
t	time
t_d	downstream travel time of the acoustic signal
t_u	upstream travel time of the acoustic signal
Δt	difference in times
U	equation coefficient or exponent
V	mean velocity
V_c	critical velocity
V_{axial}	average axial velocity of water flow
V_0	volume
W	weight
X_{avg}	mean of a set of values
X_{ind}	each individual value from a set of values
Z	potential energy head

β ratio of orifice hole diameter to pipe diameter

γ unit weight of water

θ angle

ν kinematic viscosity

σ standard deviation

Conversion Factors

Length		
Multiply	By	To obtain
Miles	1.60935	Kilometers
	1,760	Yards
	5,280	Feet
Meters	63,360	Inches
	0.00062137	Miles
	1.0936	Yards
	3.28088	Feet
	39.37	Inches
	100	Centimeters
Yards	0.001	Kilometers
	0.9144	Meters
	0.00056818	Miles
	3.0	Feet
Feet	36	Inches
	0.3048	Meters
	0.00018939	Miles
	0.33333	Yards
	12	Inches
Inches	0.08333	Feet
	0.027778	Yards
	0.000015783	Miles
	2.54	Centimeters
Area		
Square miles	4,014,489,600	Square inches
	27,878,400	Square feet
	3,097,600	Square yards
	640	Acres
	259	Hectares
Acres	208.71	Square feet
	0.404687	Hectares
	0.0015625	Square miles
	4,840	Square yards
	43,560	Square feet
Square yards	4,047	Square meters
	0.83613	
	0.0000003228	Square miles
	0.0002066	Acres
	9	Square feet
Square feet	1,296	Square inches
	0.092903	Square meters
	0.00000003587	Square miles
	0.000022957	Acres
	0.11111	Square yards
Square inches	144	Square inches
	0.000000002491	Square miles
	6.45163	Square centimeters
	0.0000001594	Acres
	0.0007716	Square yards
0.006944	Square feet	
Volume		
Acre-feet	325,851	U.S. gallons
	43,560	Cubic feet
	1,613.3	Cubic yards
Cubic yards	1,233.49	Cubic meters
	27	Cubic feet
	46,656	Cubic inches
	0.00061983	Acre-feet
Cubic feet	0.76456	Cubic meters
	1,728	Cubic inches
	7.4805	U.S. gallons
	28.317	Liters
	0.037037	Cubic yards
	0.000022957	Acre-feet

Conversion Factors (continued)

Volume (continued)		
Multiply	By	To obtain
U.S. gallons	231	Cubic inches
	3.78543	Liters
	0.13368	Cubic feet
	0.0000307	Acre-feet
	16.3872	Cubic centimeters
Cubic inches	0.004329	U.S. gallons
	0.0005787	Cubic feet
Discharge		
Cubic feet per second ^a	448.8	U.S. gallons per minute
	60	Cubic feet per minute
	3,600	Cubic feet per hour
	86,400	Cubic feet per day
	723.9669	Acre-feet per year
	1.9835	Acre-feet per day
	0.9917	Acre-inches per hour
	50	Miner's inch in Idaho, Kansas, Nebraska, South Dakota, North Dakota, New Mexico, Utah, Washington, southern California (customary)
	40	Miner's inch in Arizona, Montana, Oregon, Nevada, and California (statutory)
	38.4	Miner's inch in Colorado
	0.028317	Cubic meters per second
	1.699	Cubic meters per minute
	101.941	Cubic meters per hour
	2,446.58	Cubic meters per day
	28.317	Liters per second
Million gallons per day	1.547	Cubic feet per second ^a
	3.07	Acre-feet per day
Gallons per minute	2.629	Cubic meters per minute
	0.06309	Liters per second
	3.7854	Liters per minute
Velocity		
Feet per second	0.68	Miles per hour
	1.097	Kilometers per hour
	30.48	Centimeters per second
Inches per hour	2.540	Centimeters per hour
	0.3048	Meters per year
Acceleration		
Feet per second per second	0.3048	Meters per second per second
Weight, Mass		
Pounds, avoirdupois	0.4536	Kilograms
	16	Ounces
	7,000	Grains
	1.21528	Pounds, troy
Kilograms	1,000	Grams
	15,432	Grains
	2.2046	Pounds, avoirdupois
Tons (2,000 pounds)	907.185	Kilograms

Conversion Factors (continued)

Density		
Multiply	By	To obtain
Pounds per cubic foot	16.0185 0.0160185	Kilograms per cubic meter Grams per cubic centimeter
Pressure		
Atmosphere, at sea level	76.0 29.92 33.90 14.70	Centimeters of mercury Inches of mercury Feet of water Pounds per square inch
Pounds per square inch	0.070307 2.308	Kilograms per square centimeter Feet of water
Pounds per square foot	4.88243	Kilograms per square meter
Feet of water column (at 20 °C)	2.246 0.03041 0.4333	Centimeters of mercury column Kilograms per square centimeter Pounds per square inch
Angular Distance		
Degrees	60 3,600 0.01745	Minutes Seconds Radians
Power		
Horsepower	33,000 550 745.7 0.7457 1.014	Foot-pounds per minute Foot-pounds per second Watts Kilowatts Horsepower (metric)
Horsepower (metric)	75	Kilogram-meters per second
Work		
British thermal units	778 1055	Foot-pounds Joules
Seepage		
Cubic feet per square foot per day	304.8	Liters per square meter per day
Viscosity		
Dynamic viscosity (pound second per square foot)	4.8824	Kilogram second per square meter
Kinematic viscosity (square feet per second)	0.092903	Square meters per second
Surface Tension		
Pounds per foot	1.4882	Kilograms per meter
Gas Constant		
Feet per degree F	0.5486	Meters per degree Celsius

NOTES:

- 1 ft³/s falling 8.81 feet = 1 horsepower.
- 1 ft³/s falling 10.0 feet = 1.135 horsepower.
- 1 ft³/s falling 11.0 feet = 1 horsepower at 80-percent efficiency.
- 1 ft³/s flowing for 1 year will cover 1 square mile to a depth of 1.131 feet, or 13.572 inches.
- 1 inch depth of water on 1 square mile = 2,323,200 cubic feet = 0.0737 ft³/s for 1 year.

^aThe cubic foot per second is also commonly referred to as the second-foot.

Appendix

Water Measurement Manual

Appendix tables are numbered by chapter, beginning with the next number in sequence following the tables contained in the main body of each chapter. The following tables are located in the main body of the chapters: 7-1, 8-1, 8-2, 8-3, 8-4, 8-5, 8-6, and 9-1. Appendix tables for chapters 7, 8, and 9 begin with tables A7-2, A8-7, and A9-2, respectively.

Sharp-Crest Weirs

A7-2. Discharge of standard contracted rectangular weirs in ft³/sec.

A7-3. Discharge of standard suppressed rectangular weirs in ft³/sec.

A7-4. Discharge of 90° V-notch weirs, in ft³/sec.

A7-5. Discharge of standard Cipolletti weirs in ft³/sec. Shaded entries determined experimentally.

Parshall Flumes

A8-7. Free-flow discharge through 1-inch Parshall measuring flume in ft³/sec.

A8-8. Free-flow discharge through 2-inch Parshall measuring flume in ft³/sec.

A8-9. Free-flow discharge through 3-inch Parshall measuring flume in ft³/sec.

A8-10. Free-flow discharge through 6-inch Parshall measuring flume in ft³/sec.

A8-11. Free-flow discharge through 9-inch Parshall measuring flume in ft³/sec.

A8-12. Free-flow discharges in ft³/sec through 1- to 8-foot Parshall flumes.

A8-13. Free-flow discharge through 10-ft Parshall measuring flume in ft³/sec.

A8-14. Free-flow discharge through 12-ft Parshall measuring flume in ft³/sec.

A8-15. Free-flow discharge through 15-ft Parshall measuring flume in ft³/sec.

A8-16. Free-flow discharge through 20-ft Parshall measuring flume in ft³/sec.

A8-17. Free-flow discharge through 25-ft Parshall measuring flume in ft³/sec.

A8-18. Free-flow discharge through 30-ft Parshall measuring flume in ft³/sec.

A8-19. Free-flow discharge through 40-ft Parshall measuring flume in ft³/sec.

A8-20. Free-flow discharge through 50-ft Parshall measuring flume in ft³/sec.

Submerged Orifice Flow Meters

A9-2. Discharge of fully contracted standard submerged rectangular orifice in ft³/sec.

A9-3. Discharge of rectangular submerged orifices with bottom and side contractions suppressed, in ft³/sec.

A9-4. Discharge of constant-head orifice (CHO) turnout in ft³/sec.

A9-5. Discharge of constant-head orifice (CHO) turnout in ft³/sec.

A9-6. Discharges for standard sized constant-head orifice (CHO) turnouts.

Table A7-2. Discharge of standard contracted rectangular weirs
in ft³/sec. Shaded entries determined experimentally. All others
computed from the formula $Q=3.33(L-0.2h_1)h_1^{1.5}$.

Head, h_1 ft	Weir Length, L , ft								
	0.5	1.0	1.5	2.0	3.0	4.0	5.0	6.0	7.0
----	----	----	----	----	----	----	----	----	----
----	----	----	----	----	----	----	----	----	----
0.18	0.122	----	----	----	----	----	----	----	----
.19	.132	----	----	----	----	----	----	----	----
.20	.142	0.286	0.435	0.584	0.882	1.18	1.48	1.78	2.07
.21	.152	.307	.467	.627	.948	1.27	1.59	1.91	2.23
.22	.162	.329	.500	.672	1.02	1.36	1.70	2.05	2.39
.23	.173	.350	.534	.718	1.09	1.45	1.82	2.19	2.55
.24	.184	.373	.568	.764	1.16	1.55	1.94	2.33	2.72
.25	.195	.395	.604	.812	1.23	1.64	2.06	2.48	2.89
.26	----	.419	.639	.860	1.30	1.74	2.18	2.63	3.07
.27	----	.442	.676	.909	1.38	1.84	2.31	2.78	3.25
.28	----	.466	.712	.959	1.45	1.95	2.44	2.93	3.43
.29	----	.490	.750	1.01	1.53	2.05	2.57	3.09	3.61
.30	----	.514	.788	1.06	1.61	2.16	2.70	3.25	3.80
.31	----	.539	.827	1.11	1.69	2.26	2.84	3.41	3.99
.32	----	.564	.866	1.17	1.77	2.37	2.98	3.58	4.18
.33	----	.590	.905	1.22	1.85	2.48	3.11	3.75	4.38
.34	----	.615	.945	1.28	1.94	2.60	3.26	3.92	4.58
.35	----	.658	.986	1.33	2.02	2.71	3.40	4.09	4.78
.36	----	.686	1.03	1.39	2.11	2.83	3.54	4.26	4.98
.37	----	.714	1.07	1.44	2.19	2.94	3.69	4.44	5.19
.38	----	.743	1.11	1.50	2.28	3.06	3.84	4.62	5.40
.39	----	.772	1.15	1.56	2.37	3.18	3.99	4.80	5.61
.40	----	.801	1.20	1.62	2.46	3.30	4.14	4.99	5.83
.41	----	.830	1.24	1.68	2.55	3.43	4.30	5.17	6.05
.42	----	.860	1.28	1.74	2.64	3.55	4.46	5.36	6.27
.43	----	.890	1.33	1.80	2.74	3.68	4.61	5.55	6.49
.44	----	.920	1.37	1.86	2.83	3.80	4.77	5.75	6.72
.45	----	.950	1.42	1.92	2.93	3.93	4.94	5.94	6.95
.46	----	.981	1.46	1.98	3.02	4.06	5.10	6.14	7.18
.47	----	1.01	1.51	2.05	3.12	4.19	5.26	6.34	7.41
.48	----	1.04	1.55	2.11	3.22	4.32	5.43	6.54	7.65
.49	----	1.08	1.60	2.17	3.31	4.46	5.60	6.74	7.88
.50	----	1.11	1.65	2.24	3.41	4.59	5.77	6.95	8.12
.51	----	----	----	2.30	3.51	4.73	5.94	7.15	8.37
.52	----	----	----	2.37	3.62	4.86	6.11	7.36	8.61
.53	----	----	----	2.43	3.72	5.00	6.29	7.57	8.86
.54	----	----	----	2.50	3.82	5.14	6.46	7.79	9.11
.55	----	----	----	2.57	3.93	5.28	6.64	8.00	9.36
.56	----	----	----	2.63	4.03	5.43	6.82	8.22	9.61
.57	----	----	----	2.70	4.14	5.57	7.00	8.43	9.87
.58	----	----	----	2.77	4.24	5.71	7.18	8.65	10.1
.59	----	----	----	2.84	4.35	5.86	7.37	8.88	10.4
.60	----	----	----	2.91	4.46	6.00	7.55	9.10	10.6

Table A7-2 [continued]. Discharge of standard contracted rectangular weirs in ft³/sec. Shaded entries determined experimentally. All others computed from the formula $Q=3.33(L-0.2h_1)h_1^{1.5}$

Head, h_1 ft	2.0	3.0	4.0	5.0	6.0	7.0
0.61	2.98	4.57	6.15	7.74	9.33	10.9
.62	3.05	4.68	6.30	7.93	9.55	11.2
.63	3.12	4.79	6.45	8.12	9.78	11.4
.64	3.19	4.90	6.60	8.31	10.0	11.7
.65	3.26	5.01	6.75	8.50	10.2	12.0
.66	3.34	5.12	6.91	8.69	10.5	12.3
.67	3.41	5.23	7.06	8.89	10.7	12.5
.68	3.58	5.35	7.22	9.08	10.9	12.8
.69	3.66	5.46	7.37	9.28	11.2	13.1
.70	3.74	5.58	7.53	9.48	11.4	13.4
.71	3.82	5.69	7.69	9.68	11.7	13.7
.72	3.90	5.81	7.84	9.88	11.9	13.9
.73	3.98	5.93	8.00	10.1	12.2	14.2
.74	4.06	6.05	8.17	10.3	12.4	14.5
.75	4.14	6.16	8.33	10.5	12.7	14.8
.76	4.22	6.28	8.49	10.7	12.9	15.1
.77	4.30	6.40	8.65	10.9	13.2	15.4
.78	4.38	6.52	8.82	11.1	13.4	15.7
.79	4.46	6.65	8.98	11.3	13.7	16.0
.80	4.54	6.77	9.15	11.5	13.9	16.3
.81	4.62	6.89	9.32	11.7	14.2	16.6
.82	4.70	7.01	9.49	12.0	14.4	16.9
.83	4.78	7.14	9.65	12.2	14.7	17.2
.84	4.87	7.26	9.82	12.4	15.0	17.5
.85	4.96	7.39	9.99	12.6	15.2	17.8
.86	5.05	7.51	10.2	12.8	15.5	18.1
.87	5.14	7.64	10.3	13.0	15.7	18.4
.88	5.23	7.76	10.5	13.3	16.0	18.8
.89	5.32	7.89	10.7	13.5	16.3	19.1
.90	5.41	8.02	10.9	13.7	16.5	19.4
.91	5.50	8.15	11.0	13.9	16.8	19.7
.92	5.59	8.27	11.2	14.2	17.1	20.0
.93	5.68	8.40	11.4	14.4	17.4	20.4
.94	5.77	8.53	11.6	14.6	17.6	20.7
.95	5.86	8.66	11.7	14.8	17.9	21.0
.96	5.95	8.80	11.9	15.1	18.2	21.3
.97	6.04	8.93	12.1	15.3	18.5	21.7
.98	6.13	9.06	12.3	15.5	18.8	22.0
.99	6.22	9.19	12.5	15.8	19.0	22.3
1.00	6.31	9.32	12.7	16.0	19.3	22.6
1.01	-----	-----	12.8	16.2	19.6	23.0
1.02	-----	-----	13.0	16.5	19.9	23.3
1.03	-----	-----	13.2	16.7	20.2	23.6
1.04	-----	-----	13.4	16.9	20.5	24.0
1.05	-----	-----	13.6	17.2	20.7	24.3

Table A7-2 [continued]. Discharge of standard contracted rectangular weirs in ft³/sec. Shaded entries determined experimentally. All others computed from the formula $Q=3.33(L-0.2h_1)h_1^{1.5}$

Head, h_1 ft	Weir Length, L , ft				Head, h_1 ft	Weir Length, L , ft			
	4.0	5.0	6.0	7.0		5.0	6.0	7.0	
1.06	13.8	17.4	21.0	24.7	1.51	29.0	35.2	41.4	
1.07	14.0	17.6	21.3	25.0	1.52	29.3	35.5	41.8	
1.08	14.1	17.9	21.6	25.4	1.53	29.6	35.9	42.2	
1.09	14.3	18.1	21.9	25.7	1.54	29.9	36.2	42.6	
1.10	14.5	18.4	22.2	26.0	1.55	30.1	36.6	43.0	
1.11	14.7	18.6	22.5	26.4	1.56	30.4	36.9	43.4	
1.12	14.9	18.9	22.8	26.7	1.57	30.7	37.2	43.8	
1.13	15.1	19.1	23.1	27.1	1.58	31.0	37.6	44.2	
1.14	15.3	19.3	23.4	27.4	1.59	31.3	37.9	44.6	
1.15	15.5	19.6	23.7	27.8	1.60	31.5	38.3	45.0	
1.16	15.7	19.8	24.0	28.2	1.61	31.8	38.6	45.4	
1.17	15.9	20.1	24.3	28.5	1.62	32.1	39.0	45.8	
1.18	16.1	20.3	24.6	28.9	1.63	32.4	39.3	46.3	
1.19	16.3	20.6	24.9	29.2	1.64	32.7	39.7	46.7	
1.20	16.5	20.8	25.2	29.6	1.65	33.0	40.0	47.1	
1.21	16.7	21.1	25.5	30.0	1.66	33.2	40.4	47.5	
1.22	16.9	21.3	25.8	30.3	1.67	33.5	40.7	47.9	
1.23	17.1	21.6	26.1	30.7	1.68	-----	41.1	48.3	
1.24	17.3	21.9	26.4	31.0	1.69	-----	41.4	48.7	
1.25	17.5	22.1	26.8	31.4	1.70	-----	41.8	49.2	
1.26	17.7	22.4	27.1	31.8	1.71	-----	42.1	49.6	
1.27	17.9	22.6	27.4	32.2	1.72	-----	42.5	50.0	
1.28	18.1	22.9	27.7	32.5	1.73	-----	42.8	50.4	
1.29	18.3	23.1	28.0	32.9	1.74	-----	43.2	50.8	
1.30	18.5	23.4	28.3	33.3	1.75	-----	43.6	51.3	
1.31	18.7	23.7	28.6	33.6	1.76	-----	43.9	51.7	
1.32	18.9	23.9	29.0	34.0	1.77	-----	44.3	52.1	
1.33	19.1	24.2	29.3	34.4	1.78	-----	44.6	52.5	
1.34	-----	24.4	29.6	34.8	1.79	-----	45.0	53.0	
1.35	-----	24.7	29.9	35.2	1.80	-----	45.4	53.4	
1.36	-----	25.0	30.3	35.5	1.81	-----	45.7	53.8	
1.37	-----	25.2	30.6	35.9	1.82	-----	46.1	54.3	
1.38	-----	25.5	30.9	36.3	1.83	-----	46.4	54.7	
1.39	-----	25.8	31.2	36.7	1.84	-----	46.8	55.1	
1.40	-----	26.0	31.6	37.1	1.85	-----	47.2	55.6	
1.41	-----	26.3	31.9	37.5	1.86	-----	47.5	56.0	
1.42	-----	26.6	32.2	37.8	1.87	-----	47.9	56.4	
1.43	-----	26.8	32.5	38.2	1.88	-----	48.3	56.9	
1.44	-----	27.1	32.9	38.6	1.89	-----	48.6	57.3	
1.45	-----	27.4	33.2	39.0	1.90	-----	49.0	57.7	
1.46	-----	27.7	33.5	39.4	1.91	-----	49.4	58.2	
1.47	-----	27.9	33.9	39.8	1.92	-----	49.8	58.6	
1.48	-----	28.2	34.2	40.2	1.93	-----	50.1	59.1	
1.49	-----	28.5	34.5	40.6	1.94	-----	50.5	59.5	
1.50	-----	28.8	34.9	41.0	1.95	-----	50.9	59.9	

Table A7-2 [continued]. Discharge of standard contracted rectangular weirs in ft³/sec. Shaded entries determined experimentally. All others computed from the formula $Q=3.33(L-0.2h_1)h_1^{1.5}$

Head, h_1 ft	6.0	7.0
1.96	51.2	60.4
1.97	51.6	60.8
1.98	52.0	61.3
1.99	52.4	61.7
2.00	52.7	62.2
2.01	-----	62.6
2.02	-----	63.1
2.03	-----	63.5
2.04	-----	64.0
2.05	-----	64.4
2.06	-----	64.9
2.07	-----	65.3
2.08	-----	65.8
2.09	-----	66.2
2.10	-----	66.7
2.11	-----	67.1
2.12	-----	67.6
2.13	-----	68.1
2.14	-----	68.5
2.15	-----	69.0
2.16	-----	69.4
2.17	-----	69.9
2.18	-----	70.4
2.19	-----	70.8
2.20	-----	71.3
2.21	-----	71.7
2.22	-----	72.2
2.23	-----	72.7
2.24	-----	73.1
2.25	-----	73.6
2.26	-----	74.1
2.27	-----	74.6
2.28	-----	75.0
2.29	-----	75.5
2.30	-----	76.0
2.31	-----	76.4
2.32	-----	76.9
2.33	-----	77.4

Table A7-2 [continued]. Discharge of standard contracted rectangular weirs in ft³/sec. Shaded entries determined experimentally. All others computed from the formula $Q=3.33(L-0.2h_1)h_1^{1.5}$

Head, h_1 ft	Weir Length, L , ft						
	8.0	9.0	10.0	12.0	15.0	18.0	20.0
0.20	2.37	2.67	2.97	3.56	4.46	5.35	5.94
.30	4.34	4.89	5.44	6.53	8.17	9.82	10.91
.40	6.67	7.51	8.36	10.0	12.6	15.1	16.8
.50	9.30	10.5	11.7	14.0	17.5	21.1	23.4
.60	12.2	13.7	15.3	18.4	23.0	27.7	30.8
.70	15.3	17.3	19.2	23.1	29.0	34.8	38.7
.80	18.7	21.1	23.4	28.2	35.4	42.5	47.3
.90	22.2	25.1	27.9	33.6	42.1	50.7	56.4
1.00	26.0	29.3	32.6	39.3	49.3	59.3	65.9
1.10	29.9	33.7	37.6	45.3	56.8	68.3	76.0
1.20	34.0	38.3	42.7	51.5	64.6	77.7	86.5
1.30	38.2	43.1	48.1	57.9	72.8	87.6	97.4
1.40	42.6	48.1	53.6	64.6	81.2	97.7	109.
1.50	47.1	53.2	59.3	71.6	89.9	108.	121.
1.60	51.8	58.5	65.2	78.7	98.9	119.	133.
1.70	56.5	63.9	71.3	86.1	108.	130.	145.
1.80	61.4	69.5	77.5	93.6	118.	142.	158.
1.90	66.5	75.2	83.9	101.	128.	154.	171.
2.00	71.6	81.0	90.4	109.	138.	166.	185.
2.10	76.8	86.9	97.1	117.	148.	178.	198.
2.20	82.1	93.0	104.	126.	158.	191.	213.
2.30	87.6	99.2	111.	134.	169.	204.	227.
2.40	93.1	105.	118.	143.	180.	217.	242.
2.50	98.7	112.	125.	151.	191.	230.	257.
2.60	104.	118.	132.	160.	202.	244.	272.
2.70	110.	125.	140.	169.	214.	258.	287.
2.80	----	132.	147.	178.	225.	272.	303.
2.90	----	138.	155.	188.	237.	286.	319.
3.00	----	145.	163.	197.	249.	301.	336.
3.10	----	----	170.	207.	261.	316.	352.
3.20	----	----	178.	217.	274.	331.	369.
3.30	----	----	186.	226.	286.	346.	386.
3.40	----	----	----	236.	299.	362.	403.
3.50	----	----	----	246.	312.	377.	421.
3.60	----	----	----	257.	325.	393.	439.
3.70	----	----	----	267.	338.	409.	456.
3.80	----	----	----	277.	351.	425.	475.
3.90	----	----	----	288.	365.	442.	493.
4.00	----	----	----	298.	378.	458.	511.
4.10	----	----	----	----	392.	475.	530.
4.20	----	----	----	----	406.	492.	549.
4.30	----	----	----	----	420.	509.	568.
4.40	----	----	----	----	434.	526.	588.
4.50	----	----	----	----	448.	544.	607.

Table A7-3. Discharge of standard suppressed rectangular weirs
in ft³/sec. Computed from the formula $Q=3.33Lh_1^{1.5}$

Head h_1 , ft	Weir Length, L , ft					
	1.0	1.5	2.0	3.0	4.0	5.0
0.20	0.298	0.447	0.596	0.894	1.19	1.49
.21	.320	.481	.641	.961	1.28	1.60
.22	.344	.515	.687	1.03	1.37	1.72
.23	.367	.551	.735	1.10	1.47	1.84
.24	.392	.587	.783	1.17	1.57	1.96
.25	.416	.624	.833	1.25	1.67	2.08
.26	.441	.662	.883	1.32	1.77	2.21
.27	.467	.701	.934	1.40	1.87	2.34
.28	.493	.740	.987	1.48	1.97	2.47
.29	.520	.780	1.04	1.56	2.08	2.60
.30	.547	.821	1.09	1.64	2.19	2.74
.31	.575	.862	1.15	1.72	2.30	2.87
.32	.603	.904	1.21	1.81	2.41	3.01
.33	.631	.947	1.26	1.89	2.53	3.16
.34	----	.990	1.32	1.98	2.64	3.30
.35	----	1.03	1.38	2.07	2.76	3.45
.36	----	1.08	1.44	2.16	2.88	3.60
.37	----	1.12	1.50	2.25	3.00	3.75
.38	----	1.17	1.56	2.34	3.12	3.90
.39	----	1.22	1.62	2.43	3.24	4.06
.40	----	1.26	1.68	2.53	3.37	4.21
.41	----	1.31	1.75	2.62	3.50	4.37
.42	----	1.36	1.81	2.72	3.63	4.53
.43	----	1.41	1.88	2.82	3.76	4.69
.44	----	1.46	1.94	2.92	3.89	4.86
.45	----	1.51	2.01	3.02	4.02	5.03
.46	----	1.56	2.08	3.12	4.16	5.19
.47	----	1.61	2.15	3.22	4.29	5.36
.48	----	1.66	2.21	3.32	4.43	5.54
.49	----	1.71	2.28	3.43	4.57	5.71
.50	----	1.77	2.35	3.53	4.71	5.89
.51	----	----	2.43	3.64	4.85	6.06
.52	----	----	2.50	3.75	4.99	6.24
.53	----	----	2.57	3.85	5.14	6.42
.54	----	----	2.64	3.96	5.29	6.61
.55	----	----	2.72	4.07	5.43	6.79
.56	----	----	2.79	4.19	5.58	6.98
.57	----	----	2.87	4.30	5.73	7.17
.58	----	----	2.94	4.41	5.88	7.35
.59	----	----	3.02	4.53	6.04	7.55
.60	----	----	3.10	4.64	6.19	7.74
.61	----	----	3.17	4.76	6.35	7.93
.62	----	----	3.25	4.88	6.50	8.13
.63	----	----	3.33	5.00	6.66	8.33
.64	----	----	3.41	5.11	6.82	8.52

Table A7-3 [continued]. Discharge of standard suppressed rectangular weirs in ft³/sec. Computed from the formula $Q=3.33Lh_1^{1.5}$

Head h_1 , ft	Weir Length, L , ft				Head h_1 , ft	Weir Length, L , ft		Head h_1 , ft	L 5.0
	2.0	3.0	4.0	5.0		4.0	5.0		
0.65	3.49	5.24	6.98	8.73	1.10	15.4	19.2	1.55	32.1
.66	3.57	5.36	7.14	8.93	1.11	15.6	19.5	1.56	32.4
.67	3.65	5.48	7.30	9.13	1.12	15.8	19.7	1.57	32.8
.68	----	5.60	7.47	9.34	1.13	16.0	20.0	1.58	33.1
.69	----	5.73	7.63	9.54	1.14	16.2	20.3	1.59	33.4
.70	----	5.85	7.80	9.75	1.15	16.4	20.5	1.60	33.7
.71	----	5.98	7.97	9.96	1.16	16.6	20.8	1.61	34.0
.72	----	6.10	8.14	10.2	1.17	16.9	21.1	1.62	34.3
.73	----	6.23	8.31	10.4	1.18	17.1	21.3	1.63	34.6
.74	----	6.36	8.48	10.6	1.19	17.3	21.6	1.64	35.0
.75	----	6.49	8.65	10.8	1.20	17.5	21.9	1.65	35.3
.76	----	6.62	8.83	11.0	1.21	17.7	22.2	1.66	35.6
.77	----	6.75	9.00	11.2	1.22	17.9	22.4	1.67	35.9
.78	----	6.88	9.18	11.5	1.23	18.2	22.7		
.79	----	7.01	9.35	11.7	1.24	18.4	23.0		
.80	----	7.15	9.53	11.9	1.25	18.6	23.3		
.81	----	7.28	9.71	12.1	1.26	18.8	23.5		
.82	----	7.42	9.89	12.4	1.27	19.1	23.8		
.83	----	7.55	10.1	12.6	1.28	19.3	24.1		
.84	----	7.69	10.3	12.8	1.29	19.5	24.4		
.85	----	7.83	10.4	13.0	1.30	19.7	24.7		
.86	----	7.97	10.6	13.3	1.31	20.0	25.0		
.87	----	8.11	10.8	13.5	1.32	20.2	25.3		
.88	----	8.25	11.0	13.7	1.33	20.4	25.5		
.89	----	8.39	11.2	14.0	1.34	----	25.8		
.90	----	8.53	11.4	14.2	1.35	----	26.1		
.91	----	8.67	11.6	14.5	1.36	----	26.4		
.92	----	8.82	11.8	14.7	1.37	----	26.7		
.93	----	8.96	11.9	14.9	1.38	----	27.0		
.94	----	9.10	12.1	15.2	1.39	----	27.3		
.95	----	9.25	12.3	15.4	1.40	----	27.6		
.96	----	9.40	12.5	15.7	1.41	----	27.9		
.97	----	9.54	12.7	15.9	1.42	----	28.2		
.98	----	9.69	12.9	16.2	1.43	----	28.5		
.99	----	9.84	13.1	16.4	1.44	----	28.8		
1.00	----	9.99	13.3	16.7	1.45	----	29.1		
1.01	----	----	13.5	16.9	1.46	----	29.4		
1.02	----	----	13.7	17.2	1.47	----	29.7		
1.03	----	----	13.9	17.4	1.48	----	30.0		
1.04	----	----	14.1	17.7	1.49	----	30.3		
1.05	----	----	14.3	17.9	1.50	----	30.6		
1.06	----	----	14.5	18.2	1.51	----	30.9		
1.07	----	----	14.7	18.4	1.52	----	31.2		
1.08	----	----	14.9	18.7	1.53	----	31.5		
1.09	----	----	15.2	18.9	1.54	----	31.8		

Table A7-4. Discharge of 90° V-notch weirs, in ft³/sec, computed from the formula $Q=2.49h_1^{2.48}$.

Head H, ft	Discharge Q, ft ³ /sec	Head H, ft	Discharge Q, ft ³ /sec	Head H, ft	Discharge Q, ft ³ /sec	Head H, ft	Discharge Q, ft ³ /sec
0.20	0.046	0.65	0.856	1.10	3.15	1.55	7.38
.21	.052	.66	.889	1.11	3.23	1.56	7.50
.22	.058	.67	.922	1.12	3.30	1.57	7.62
.23	.065	.68	.957	1.13	3.37	1.58	7.74
.24	.072	.69	.992	1.14	3.45	1.59	7.86
.25	.080	.70	1.03	1.15	3.52	1.60	7.99
.26	.088	.71	1.06	1.16	3.60	1.61	8.11
.27	.097	.72	1.10	1.17	3.68	1.62	8.24
.28	.106	.73	1.14	1.18	3.75	1.63	8.36
.29	.116	.74	1.18	1.19	3.83	1.64	8.49
.30	.126	.75	1.22	1.20	3.91	1.65	8.62
.31	.136	.76	1.26	1.21	3.99	1.66	8.75
.32	.148	.77	1.30	1.22	4.08	1.67	8.88
.33	.159	.78	1.34	1.23	4.16	1.68	9.02
.34	.172	.79	1.39	1.24	4.25	1.69	9.15
.35	.184	.80	1.43	1.25	4.33	1.70	9.28
.36	.198	.81	1.48	1.26	4.42	1.71	9.42
.37	.212	.82	1.52	1.27	4.50	1.72	9.56
.38	.226	.83	1.57	1.28	4.59	1.73	9.70
.39	.241	.84	1.62	1.29	4.68	1.74	9.83
.40	.257	.85	1.66	1.30	4.77	1.75	9.98
.41	.273	.86	1.71	1.31	4.86	1.76	10.1
.42	.290	.87	1.76	1.32	4.96	1.77	10.3
.43	.307	.88	1.81	1.33	5.05	1.78	10.4
.44	.325	.89	1.87	1.34	5.15	1.79	10.6
.45	.344	.90	1.92	1.35	5.24	1.80	10.7
.46	.363	.91	1.97	1.36	5.34	1.81	10.8
.47	.383	.92	2.02	1.37	5.44	1.82	11.0
.48	.403	.93	2.08	1.38	5.53	1.83	11.1
.49	.425	.94	2.14	1.39	5.63	1.84	11.3
.50	.446	.95	2.19	1.40	5.74	1.85	11.4
.51	.469	.96	2.25	1.41	5.84	1.86	11.6
.52	.492	.97	2.31	1.42	5.94	1.87	11.8
.53	.516	.98	2.37	1.43	6.05	1.88	11.9
.54	.540	.99	2.43	1.44	6.15	1.89	12.1
.55	.565	1.00	2.49	1.45	6.26	1.90	12.2
.56	.591	1.01	2.55	1.46	6.36	1.91	12.4
.57	.618	1.02	2.62	1.47	6.47	1.92	12.6
.58	.645	1.03	2.68	1.48	6.58	1.93	12.7
.59	.673	1.04	2.74	1.49	6.69	1.94	12.9
.60	.701	1.05	2.81	1.50	6.81	1.95	13.0
.61	.731	1.06	2.88	1.51	6.92	1.96	13.2
.62	.761	1.07	2.94	1.52	7.03	1.97	13.4
.63	.792	1.08	3.01	1.53	7.15	1.98	13.5
.64	.823	1.09	3.08	1.54	7.27	1.99	13.7

Table A7-5. Discharge of standard Cipolletti weirs in ft³/sec.
 Shaded entries determined experimentally. Others computed
 from the formula $Q=3.367Lh_1^{1.5}$

Head H, ft	Weir Length, L, ft						
	0.5	1.0	1.5	2.0	3.0	4.0	5.0
----	----	----	----	----	----	----	----
----	----	----	----	----	----	----	----
.18	.129	----	----	----	----	----	----
.19	.139	----	----	----	----	----	----
.20	.151	.301	.452	.602	.903	1.20	1.51
.21	.162	.324	.486	.648	.972	1.30	1.62
.22	.174	.347	.521	.695	1.04	1.39	1.74
.23	.186	.371	.557	.743	1.11	1.49	1.86
.24	.200	.396	.594	.792	1.19	1.58	1.98
.25	.214	.421	.631	.842	1.26	1.68	2.10
.26	----	.446	.670	.893	1.34	1.79	2.23
.27	----	.472	.709	.945	1.42	1.89	2.36
.28	----	.499	.748	.998	1.50	2.00	2.49
.29	----	.526	.789	1.05	1.58	2.10	2.63
.30	----	.553	.830	1.11	1.66	2.21	2.77
.31	----	.581	.872	1.16	1.74	2.32	2.91
.32	----	.609	.914	1.22	1.83	2.44	3.05
.33	----	.638	.957	1.28	1.91	2.55	3.19
.34	----	.668	1.00	1.34	2.00	2.67	3.34
.35	----	.697	1.05	1.39	2.09	2.79	3.49
.36	----	.727	1.09	1.45	2.18	2.91	3.64
.37	----	.758	1.14	1.52	2.27	3.03	3.79
.38	----	.789	1.18	1.58	2.37	3.15	3.94
.39	----	.820	1.23	1.64	2.46	3.28	4.10
.40	----	.852	1.28	1.70	2.56	3.41	4.26
.41	----	.884	1.33	1.77	2.65	3.54	4.42
.42	----	.916	1.37	1.83	2.75	3.67	4.58
.43	----	.949	1.42	1.90	2.85	3.80	4.75
.44	----	.983	1.47	1.97	2.95	3.93	4.91
.45	----	1.02	1.52	2.03	3.05	4.07	5.08
.46	----	1.05	1.58	2.10	3.15	4.20	5.25
.47	----	1.08	1.63	2.17	3.25	4.34	5.42
.48	----	1.12	1.68	2.24	3.36	4.48	5.60
.49	----	1.16	1.73	2.31	3.46	4.62	5.77
.50	----	1.20	1.79	2.38	3.57	4.76	5.95
.51	----	----	----	2.45	3.68	4.91	6.13
.52	----	----	----	2.53	3.79	5.05	6.31
.53	----	----	----	2.60	3.90	5.20	6.50
.54	----	----	----	2.67	4.01	5.34	6.68
.55	----	----	----	2.75	4.12	5.49	6.87
.56	----	----	----	2.82	4.23	5.64	7.05
.57	----	----	----	2.90	4.35	5.80	7.24
.58	----	----	----	2.97	4.46	5.95	7.44
.59	----	----	----	3.05	4.58	6.10	7.63
.60	----	----	----	3.13	4.69	6.26	7.82

Table A7-5 [continued]. Discharge of standard Cipolletti weirs in ft³/sec.
 Shaded entries determined experimentally. Others computed from the
 formula $Q=3.367Lh_1^{1.5}$

Head <i>H</i> , ft	Weir Length, <i>L</i> , ft				Head <i>H</i> , ft	Weir Length, <i>L</i> , ft			Head <i>H</i> , ft	<i>L</i> 5.0
	2.0	3.0	4.0	5.0		3.0	4.0	5.0		
0.61	3.21	4.81	6.42	8.02	1.06	11.3	14.7	18.4	1.51	31.2
.62	3.29	4.93	6.57	8.22	1.07	11.4	14.9	18.6	1.52	31.5
.63	3.37	5.05	6.73	8.42	1.08	11.6	15.1	18.9	1.53	31.9
.64	3.45	5.17	6.90	8.62	1.09	11.7	15.3	19.2	1.54	32.2
.65	3.53	5.29	7.06	8.82	1.10	11.9	15.5	19.4	1.55	32.5
.66	3.61	5.42	7.22	9.03	1.11	12.1	15.8	19.7	1.56	32.8
.67	3.69	5.54	7.39	9.23	1.12	12.2	16.0	20.0	1.57	33.1
.68	3.81	5.66	7.55	9.44	1.13	12.4	16.2	20.2	1.58	33.4
.69	3.90	5.79	7.72	9.65	1.14	12.5	16.4	20.5	1.59	33.8
.70	3.98	5.92	7.89	9.86	1.15	12.7	16.6	20.8	1.60	34.1
.71	4.06	6.04	8.06	10.1	1.16	12.9	16.8	21.0	1.61	34.4
.72	4.15	6.17	8.23	10.3	1.17	13.0	17.0	21.3	1.62	34.7
.73	4.24	6.30	8.40	10.5	1.18	13.2	17.3	21.6	1.63	35.0
.74	4.33	6.43	8.57	10.7	1.19	13.4	17.5	21.9	1.64	35.4
.75	4.42	6.56	8.75	10.9	1.20	13.6	17.7	22.1	1.65	35.7
.76	4.51	6.69	8.92	11.2	1.21	13.7	17.9	22.4	1.66	36.0
.77	4.60	6.82	9.10	11.4	1.22	13.9	18.1	22.7	1.67	36.3
.78	4.69	6.96	9.28	11.6	1.23	14.1	18.4	23.0		
.79	4.78	7.09	9.46	11.8	1.24	14.3	18.6	23.2		
.80	4.87	7.23	9.64	12.0	1.25	14.4	18.8	23.5		
.81	4.96	7.36	9.82	12.3	1.26	14.6	19.0	23.8		
.82	5.05	7.50	10.0	12.5	1.27	14.8	19.3	24.1		
.83	5.14	7.64	10.2	12.7	1.28	15.0	19.5	24.4		
.84	5.24	7.78	10.4	13.0	1.29	15.2	19.7	24.7		
.85	5.34	7.92	10.6	13.2	1.30	15.4	20.0	25.0		
.86	5.44	8.06	10.7	13.4	1.31	15.5	20.2	25.2		
.87	5.54	8.20	10.9	13.7	1.32	15.7	20.4	25.5		
.88	5.64	8.34	11.1	13.9	1.33	15.9	20.7	25.8		
.89	5.74	8.48	11.3	14.1	1.34	16.1	-----	26.1		
.90	5.84	8.62	11.5	14.4	1.35	16.2	-----	26.4		
.91	5.94	8.77	11.7	14.6	1.36	16.4	-----	26.7		
.92	6.04	8.91	11.9	14.9	1.37	16.6	-----	27.0		
.93	6.14	9.06	12.1	15.1	1.38	16.8	-----	27.3		
.94	6.25	9.21	12.3	15.3	1.39	17.0	-----	27.6		
.95	6.36	9.35	12.5	15.6	1.40	17.2	-----	27.9		
.96	6.47	9.50	12.7	15.8	1.41	17.4	-----	28.2		
.97	6.58	9.65	12.9	16.1	1.42	17.6	-----	28.5		
.98	6.69	9.80	13.1	16.3	1.43	17.8	-----	28.8		
.99	6.80	9.95	13.3	16.6	1.44	18.0	-----	29.1		
1.00	6.91	10.1	13.5	16.8	1.45	18.2	-----	29.4		
1.01	-----	10.5	13.7	17.1	1.46	18.3	-----	29.7		
1.02	-----	10.6	13.9	17.3	1.47	18.5	-----	30.0		
1.03	-----	10.8	14.1	17.6	1.48	18.7	-----	30.3		
1.04	-----	10.9	14.3	17.9	1.49	18.9	-----	30.6		
1.05	-----	11.1	14.5	18.1	1.50	19.1	-----	30.9		

Table A7-5 [continued]. Discharge of standard Cipolletti weirs in ft³/sec.
 Shaded entries determined experimentally. Others computed from the
 formula $Q=3.367Lh_1^{1.5}$

Head <i>H</i> , ft	Weir Length, <i>L</i> , ft				Head <i>H</i> , ft	Weir Length, <i>L</i> , ft			
	6.0	7.0	8.0	9.0		6.0	7.0	8.0	9.0
0.20	1.81	2.11	2.41	2.71	0.65	10.6	12.4	14.1	15.9
.21	1.94	2.27	2.59	2.92	.66	10.8	12.6	14.4	16.2
.22	2.08	2.43	2.78	3.13	.67	11.1	12.9	14.8	16.6
.23	2.23	2.60	2.97	3.34	.68	11.3	13.2	15.1	17.0
.24	2.38	2.77	3.17	3.56	.69	11.6	13.5	15.4	17.4
.25	2.53	2.95	3.37	3.79	.70	11.8	13.8	15.8	17.7
.26	2.68	3.12	3.57	4.02	.71	12.1	14.1	16.1	18.1
.27	2.83	3.31	3.78	4.25	.72	12.3	14.4	16.5	18.5
.28	2.99	3.49	3.99	4.49	.73	12.6	14.7	16.8	18.9
.29	3.15	3.68	4.21	4.73	.74	12.9	15.0	17.1	19.3
.30	3.32	3.87	4.43	4.98	.75	13.1	15.3	17.5	19.7
.31	3.49	4.07	4.65	5.23	.76	13.4	15.6	17.8	20.1
.32	3.66	4.27	4.88	5.49	.77	13.6	15.9	18.2	20.5
.33	3.83	4.47	5.11	5.74	.78	13.9	16.2	18.6	20.9
.34	4.01	4.67	5.34	6.01	.79	14.2	16.5	18.9	21.3
.35	4.18	4.88	5.58	6.27	.80	14.5	16.9	19.3	21.7
.36	4.36	5.09	5.82	6.55	.81	14.7	17.2	19.6	22.1
.37	4.55	5.30	6.06	6.82	.82	15.0	17.5	20.0	22.5
.38	4.73	5.52	6.31	7.10	.83	15.3	17.8	20.4	22.9
.39	4.92	5.74	6.56	7.38	.84	15.6	18.1	20.7	23.3
.40	5.11	5.96	6.81	7.67	.85	15.8	18.5	21.1	23.7
.41	5.30	6.19	7.07	7.96	.86	16.1	18.8	21.5	24.2
.42	5.50	6.42	7.33	8.25	.87	16.4	19.1	21.9	24.6
.43	5.70	6.65	7.60	8.54	.88	16.7	19.5	22.2	25.0
.44	5.90	6.88	7.86	8.84	.89	17.0	19.8	22.6	25.4
.45	6.10	7.11	8.13	9.15	.90	17.2	20.1	23.0	25.9
.46	6.30	7.35	8.40	9.45	.91	17.5	20.5	23.4	26.3
.47	6.51	7.59	8.68	9.76	.92	17.8	20.8	23.8	26.7
.48	6.72	7.84	8.96	10.1	.93	18.1	21.1	24.2	27.2
.49	6.93	8.08	9.24	10.4	.94	18.4	21.5	24.5	27.6
.50	7.14	8.33	9.52	10.7	.95	18.7	21.8	24.9	28.1
.51	7.36	8.58	9.81	11.0	.96	19.0	22.2	25.3	28.5
.52	7.58	8.84	10.1	11.4	.97	19.3	22.5	25.7	28.9
.53	7.79	9.09	10.4	11.7	.98	19.6	22.9	26.1	29.4
.54	8.02	9.35	10.7	12.0	.99	19.9	23.2	26.5	29.8
.55	8.24	9.61	11.0	12.4	1.00	20.2	23.6	26.9	30.3
.56	8.47	9.88	11.3	12.7	1.01	20.5	23.9	27.3	30.8
.57	8.69	10.1	11.6	13.0	1.02	20.8	24.3	27.7	31.2
.58	8.92	10.4	11.9	13.4	1.03	21.1	24.6	28.2	31.7
.59	9.16	10.7	12.2	13.7	1.04	21.4	25.0	28.6	32.1
.60	9.39	11.0	12.5	14.1	1.05	21.7	25.4	29.0	32.6
.61	9.62	11.2	12.8	14.4	1.06	22.0	25.7	29.4	33.1
.62	9.86	11.5	13.1	14.8	1.07	22.4	26.1	29.8	33.5
.63	10.1	11.8	13.5	15.2	1.08	22.7	26.5	30.2	34.0
.64	10.3	12.1	13.8	15.5	1.09	23.0	26.8	30.7	34.5

Table A7-5 [continued]. Discharge of standard Cipolletti weirs in ft³/sec.
 Shaded entries determined experimentally. Others computed from the
 formula $Q=3.367Lh_1^{1.5}$

Head <i>H</i> , ft	Weir Length, <i>L</i> , ft				Head <i>H</i> , ft	Weir Length, <i>L</i> , ft			
	6.0	7.0	8.0	9.0		6.0	7.0	8.0	9.0
1.10	23.3	27.2	31.1	35.0	1.55	39.0	45.5	52.0	58.5
1.11	23.6	27.6	31.5	35.4	1.56	39.4	45.9	52.5	59.0
1.12	23.9	27.9	31.9	35.9	1.57	39.7	46.4	53.0	59.6
1.13	24.3	28.3	32.4	36.4	1.58	40.1	46.8	53.5	60.2
1.14	24.6	28.7	32.8	36.9	1.59	40.5	47.3	54.0	60.8
1.15	24.9	29.1	33.2	37.4	1.60	40.9	47.7	54.5	61.3
1.16	25.2	29.4	33.7	37.9	1.61	41.3	48.1	55.0	61.9
1.17	25.6	29.8	34.1	38.3	1.62	41.7	48.6	55.5	62.5
1.18	25.9	30.2	34.5	38.8	1.63	42.0	49.0	56.1	63.1
1.19	26.2	30.6	35.0	39.3	1.64	42.4	49.5	56.6	63.6
1.20	26.6	31.0	35.4	39.8	1.65	42.8	50.0	57.1	64.2
1.21	26.9	31.4	35.9	40.3	1.66	43.2	50.4	57.6	64.8
1.22	27.2	31.8	36.3	40.8	1.67	43.6	50.9	58.1	65.4
1.23	27.6	32.2	36.7	41.3	1.68	44.0	51.3	58.7	66.0
1.24	27.9	32.5	37.2	41.8	1.69	44.4	51.8	59.2	66.6
1.25	28.2	32.9	37.6	42.3	1.70	44.8	52.2	59.7	67.2
1.26	28.6	33.3	38.1	42.9	1.71	45.2	52.7	60.2	67.8
1.27	28.9	33.7	38.6	43.4	1.72	45.6	53.2	60.8	68.4
1.28	29.3	34.1	39.0	43.9	1.73	46.0	53.6	61.3	69.0
1.29	29.6	34.5	39.5	44.4	1.74	46.4	54.1	61.8	69.6
1.30	29.9	34.9	39.9	44.9	1.75	46.8	54.6	62.4	70.2
1.31	30.3	35.3	40.4	45.4	1.76	47.2	55.0	62.9	70.8
1.32	30.6	35.7	40.9	46.0	1.77	47.6	55.5	63.4	71.4
1.33	31.0	36.2	41.3	46.5	1.78	48.0	56.0	64.0	72.0
1.34	31.3	36.6	41.8	47.0	1.79	48.4	56.4	64.5	72.6
1.35	31.7	37.0	42.3	47.5	1.80	48.8	56.9	65.0	73.2
1.36	32.0	37.4	42.7	48.1	1.81	49.2	57.4	65.6	73.8
1.37	32.4	37.8	43.2	48.6	1.82	49.6	57.9	66.1	74.4
1.38	32.8	38.2	43.7	49.1	1.83	50.0	58.3	66.7	75.0
1.39	33.1	38.6	44.1	49.7	1.84	50.4	58.8	67.2	75.6
1.40	33.5	39.0	44.6	50.2	1.85	50.8	59.3	67.8	76.3
1.41	33.8	39.5	45.1	50.7	1.86	51.2	59.8	68.3	76.9
1.42	34.2	39.9	45.6	51.3	1.87	51.7	60.3	68.9	77.5
1.43	34.5	40.3	46.1	51.8	1.88	52.1	60.8	69.4	78.1
1.44	34.9	40.7	46.5	52.4	1.89	52.5	61.2	70.0	78.7
1.45	35.3	41.2	47.0	52.9	1.90	52.9	61.7	70.5	79.4
1.46	35.6	41.6	47.5	53.5	1.91	53.3	62.2	71.1	80.0
1.47	36.0	42.0	48.0	54.0	1.92	53.7	62.7	71.7	80.6
1.48	36.4	42.4	48.5	54.6	1.93	54.2	63.2	72.2	81.2
1.49	36.7	42.9	49.0	55.1	1.94	54.6	63.7	72.8	81.9
1.50	37.1	43.3	49.5	55.7	1.95	55.0	64.2	73.3	82.5
1.51	37.5	43.7	50.0	56.2	1.96	55.4	64.7	73.9	83.2
1.52	37.9	44.2	50.5	56.8	1.97	55.9	65.2	74.5	83.8
1.53	38.2	44.6	51.0	57.3	1.98	56.3	65.7	75.0	84.4
1.54	38.6	45.0	51.5	57.9	1.99	56.7	66.2	75.6	85.1

Table A7-5 [continued]. Discharge of standard Cipolletti weirs in ft³/sec.
 Shaded entries determined experimentally. Others computed from the
 formula $Q=3.367Lh_1^{1.5}$

Head <i>H</i> , ft	Weir Length, <i>L</i> , ft				Head <i>H</i> , ft	<i>L</i> , ft		Head <i>H</i> , ft	<i>L</i> 9.0
	6.0	7.0	8.0	9.0		8.0	9.0		
2.00	57.1	66.7	76.2	85.7	2.45	103.	116.	2.90	150.
2.01	-----	67.2	76.8	86.4	2.46	104.	117.	2.91	150.
2.02	-----	67.7	77.3	87.0	2.47	105.	118.	2.92	151.
2.03	-----	68.2	77.9	87.6	2.48	105.	118.	2.93	152.
2.04	-----	68.7	78.5	88.3	2.49	106.	119.	2.94	153.
2.05	-----	69.2	79.1	88.9	2.50	106.	120.	2.95	154.
2.06	-----	69.7	79.6	89.6	2.51	107.	121.	2.96	154.
2.07	-----	70.2	80.2	90.2	2.52	108.	121.	2.97	155.
2.08	-----	70.7	80.8	90.9	2.53	108.	122.	2.98	156.
2.09	-----	71.2	81.4	91.6	2.54	109.	123.	2.99	157.
2.10	-----	71.7	82.0	92.2	2.55	110.	123.	3.00	157.
2.11	-----	72.2	82.6	92.9	2.56	110.	124.		
2.12	-----	72.8	83.1	93.5	2.57	111.	125.		
2.13	-----	73.3	83.7	94.2	2.58	112.	126.		
2.14	-----	73.8	84.3	94.9	2.59	112.	126.		
2.15	-----	74.3	84.9	95.5	2.60	113.	127.		
2.16	-----	74.8	85.5	96.2	2.61	114.	128.		
2.17	-----	75.3	86.1	96.9	2.62	114.	129.		
2.18	-----	75.9	86.7	97.5	2.63	115.	129.		
2.19	-----	76.4	87.3	98.2	2.64	116.	130.		
2.20	-----	76.9	87.9	98.9	2.65	116.	131.		
2.21	-----	77.4	88.5	100.	2.66	117.	131.		
2.22	-----	78.0	89.1	100.	2.67	118.	132.		
2.23	-----	78.5	89.7	101.	2.68	-----	133.		
2.24	-----	79.0	90.3	102.	2.69	-----	134.		
2.25	-----	79.5	90.9	102.	2.70	-----	134.		
2.26	-----	80.1	91.5	103.	2.71	-----	135.		
2.27	-----	80.6	92.1	104.	2.72	-----	136.		
2.28	-----	81.1	92.7	104.	2.73	-----	137.		
2.29	-----	81.7	93.3	105.	2.74	-----	137.		
2.30	-----	82.2	94.0	106.	2.75	-----	138.		
2.31	-----	82.7	94.6	106.	2.76	-----	139.		
2.32	-----	83.3	95.2	107.	2.77	-----	140.		
2.33	-----	83.8	95.8	108.	2.78	-----	140.		
2.34	-----	-----	96.4	108.	2.79	-----	141.		
2.35	-----	-----	97.0	109.	2.80	-----	142.		
2.36	-----	-----	97.7	110.	2.81	-----	143.		
2.37	-----	-----	98.3	111.	2.82	-----	144.		
2.38	-----	-----	98.9	111.	2.83	-----	144.		
2.39	-----	-----	100.	112.	2.84	-----	145.		
2.40	-----	-----	100.	113.	2.85	-----	146.		
2.41	-----	-----	101.	113.	2.86	-----	147.		
2.42	-----	-----	101.	114.	2.87	-----	147.		
2.43	-----	-----	102.	115.	2.88	-----	148.		
2.44	-----	-----	103.	115.	2.89	-----	149.		

Table A8-7. Free-flow discharge through 1-inch Parshall measuring flume in ft^3/sec . Computed from the formula $Q=0.338h_a^{1.55}$.

Upper Head h_a , ft	Hundredths									
	0.00	0.01	0.02	0.03	0.04	0.05	0.06	0.07	0.08	0.09
0.00	----	----	----	----	----	0.0033	0.0043	0.0055	0.0067	0.0081
0.10	0.0095	0.0110	0.0126	0.0143	0.0160	.0179	.0197	.0217	.0237	.0258
0.20	.028	.030	.032	.035	.037	.039	.042	.044	.047	.050
0.30	.052	.055	.058	.061	.063	.066	.069	.072	.075	.079
0.40	.082	.085	.088	.091	.095	.098	.101	.105	.108	.112
0.50	.115	.119	.123	.126	.130	.134	.138	.141	.145	.149
0.60	.153	.157	.161	.165	.169	.173	.178	.182	.186	.190

Table A8-8. Free-flow discharge through 2-inch Parshall measuring flume in ft^3/sec . Computed from the formula $Q=0.676h_a^{1.55}$.

Upper Head h_a , ft	Hundredths									
	0.00	0.01	0.02	0.03	0.04	0.05	0.06	0.07	0.08	0.09
0.00	----	----	----	----	----	0.0065	0.0086	0.0110	0.0135	0.0162
0.10	0.0191	0.0221	0.0253	0.0286	0.0321	.0357	.0395	.0434	.0474	.0515
0.20	.056	.060	.065	.069	.074	.079	.084	.089	.094	.099
0.30	.105	.110	.116	.121	.127	.133	.139	.145	.151	.157
0.40	.163	.170	.176	.183	.189	.196	.203	.210	.217	.224
0.50	.231	.238	.245	.253	.260	.268	.275	.283	.291	.298
0.60	.306	.314	.322	.330	.338	.347	.355	.363	.372	.380
0.70	.389	.398	.406	.415	.424	.433	.442	.451	.460	.469

Table A8-9. Free-flow discharge through 3-inch Parshall measuring flume in ft^3/sec . Computed from the formula $Q=0.992h_a^{1.55}$.

Upper Head h_a , ft	Hundredths									
	0.00	0.01	0.02	0.03	0.04	0.05	0.06	0.07	0.08	0.09
0.00	----	----	----	----	----	0.0095	0.0127	0.0161	0.0198	0.0237
0.10	0.0280	0.0324	0.0371	0.0420	0.0471	.0524	.0579	.0636	.0695	.0756
0.20	.082	.088	.095	.102	.109	.116	.123	.130	.138	.146
0.30	.153	.161	.170	.178	.186	.195	.204	.212	.221	.230
0.40	.240	.249	.259	.268	.278	.288	.298	.308	.318	.328
0.50	.339	.349	.360	.371	.382	.393	.404	.415	.426	.438
0.60	.449	.461	.473	.485	.497	.509	.521	.533	.546	.558
0.70	.571	.583	.596	.609	.622	.635	.648	.662	.675	.688
0.80	.702	.716	.729	.743	.757	.771	.785	.799	.814	.828
0.90	.843	.857	.872	.886	.901	.916	.931	.946	.961	.977
1.00	.992	1.007	1.023	1.039	1.054	1.070	1.086	1.102	1.118	1.134

Table A8-10. Free-flow discharge through 6-inch Parshall measuring flume in ft³/sec. Computed from the formula $Q=2.06h_a^{1.58}$

Upper Head h_a , ft	Hundredths									
	0.00	0.01	0.02	0.03	0.04	0.05	0.06	0.07	0.08	0.09
0.10	0.05	0.06	0.07	0.08	0.09	0.10	0.11	0.13	0.14	0.15
.20	.16	.17	.19	.20	.22	.23	.25	.26	.28	.29
.30	.31	.32	.34	.36	.37	.39	.41	.43	.45	.47
.40	.48	.50	.52	.54	.56	.58	.60	.62	.65	.67
.50	.69	.71	.73	.76	.78	.80	.82	.85	.87	.89
.60	.92	.94	.97	.99	1.02	1.04	1.07	1.09	1.12	1.15
.70	1.17	1.20	1.23	1.25	1.28	1.31	1.34	1.36	1.39	1.42
.80	1.45	1.48	1.51	1.53	1.56	1.59	1.62	1.65	1.68	1.71
.90	1.74	1.77	1.81	1.84	1.87	1.90	1.93	1.96	2.00	2.03
1.00	2.06	2.09	2.13	2.16	2.19	2.23	2.26	2.29	2.33	2.36
1.10	2.39	2.43	2.46	2.50	2.53	2.57	2.60	2.64	2.68	2.71
1.20	2.75	2.78	2.82	2.86	2.89	2.93	2.97	3.01	3.04	3.08

Table A8-11. Free-flow discharge through 9-inch Parshall measuring flume in ft³/sec. Computed from the formula $Q=3.07h_a^{1.53}$

Upper Head h_a , ft	Hundredths									
	0.00	0.01	0.02	0.03	0.04	0.05	0.06	0.07	0.08	0.09
0.10	0.09	0.10	0.12	0.14	0.15	0.17	0.19	0.20	0.22	0.24
.20	.26	.28	.30	.32	.35	.37	.39	.41	.44	.46
.30	.49	.51	.54	.56	.59	.62	.64	.67	.70	.73
.40	.76	.78	.81	.84	.87	.90	.94	.97	1.00	1.03
.50	1.06	1.10	1.13	1.16	1.20	1.23	1.26	1.30	1.33	1.37
.60	1.41	1.44	1.48	1.51	1.55	1.59	1.63	1.66	1.70	1.74
.70	1.78	1.82	1.86	1.90	1.94	1.98	2.02	2.06	2.10	2.14
.80	2.18	2.22	2.27	2.31	2.35	2.39	2.44	2.48	2.52	2.57
.90	2.61	2.66	2.70	2.75	2.79	2.84	2.88	2.93	2.98	3.02
1.00	3.07	3.12	3.16	3.21	3.26	3.31	3.36	3.40	3.45	3.50
1.10	3.55	3.60	3.65	3.70	3.75	3.80	3.85	3.90	3.95	4.01
1.20	4.06	4.11	4.16	4.21	4.27	4.32	4.37	4.43	4.48	4.53
1.30	4.59	4.64	4.69	4.75	4.80	4.86	4.91	4.97	5.03	5.08
1.40	5.14	5.19	5.25	5.31	5.36	5.42	5.48	5.54	5.59	5.65
1.50	5.71	5.77	5.83	5.88	5.94	6.00	6.06	6.12	6.18	6.24

Table A8-12 [continued]. Free-flow discharges in ft³/sec through 1- to 8-foot Parshall flumes. Discharges for 2- to 8-ft flumes computed from the formula $Q=4.00Wh_a^{1.522(W^{0.026})}$. Discharges for 1-ft flume computed from the formula $Q=3.95h_a^{1.55}$.

Upper Head h_a , ft	Discharge for flumes of various throat widths, W							
	1.0	2.0	3.0	4.0	5.0	6.0	7.0	8.0
0.20	0.33	0.66	0.96	1.26	----	----	----	----
.21	.35	.71	1.04	1.36	----	----	----	----
.22	.38	.77	1.12	1.47	----	----	----	----
.23	.40	.82	1.20	1.57	----	----	----	----
.24	.43	.88	1.28	1.68	----	----	----	----
.25	.46	.93	1.37	1.80	2.22	2.63	----	----
.26	.49	.99	1.46	1.91	2.36	2.80	----	----
.27	.52	1.05	1.54	2.03	2.50	2.97	----	----
.28	.55	1.11	1.63	2.15	2.65	3.15	----	----
.29	.58	1.17	1.73	2.27	2.80	3.33	----	----
.30	.61	1.24	1.82	2.39	2.96	3.52	4.07	4.63
.31	.64	1.30	1.92	2.52	3.12	3.71	4.29	4.88
.32	.68	1.37	2.01	2.65	3.28	3.90	4.52	5.13
.33	.71	1.44	2.11	2.78	3.44	4.10	4.75	5.39
.34	.74	1.50	2.22	2.92	3.61	4.30	4.98	5.66
.35	.78	1.57	2.32	3.05	3.78	4.50	5.21	5.92
.36	.81	1.64	2.42	3.19	3.95	4.71	5.46	6.20
.37	.85	1.71	2.53	3.33	4.13	4.92	5.70	6.48
.38	.88	1.79	2.64	3.48	4.31	5.13	5.95	6.76
.39	.92	1.86	2.75	3.62	4.49	5.35	6.20	7.05
.40	.95	1.93	2.86	3.77	4.67	5.57	6.46	7.34
.41	.99	2.01	2.97	3.92	4.86	5.79	6.72	7.64
.42	1.03	2.09	3.08	4.07	5.05	6.02	6.98	7.94
.43	1.07	2.16	3.20	4.22	5.24	6.25	7.25	8.25
.44	1.11	2.24	3.32	4.38	5.43	6.48	7.52	8.56
.45	1.15	2.32	3.44	4.54	5.63	6.72	7.80	8.87
.46	1.19	2.40	3.56	4.70	5.83	6.96	8.08	9.19
.47	1.23	2.48	3.68	4.86	6.03	7.20	8.36	9.51
.48	1.27	2.57	3.80	5.03	6.24	7.45	8.65	9.84
.49	1.31	2.65	3.93	5.19	6.45	7.69	8.94	10.2
.50	1.35	2.73	4.05	5.36	6.66	7.95	9.23	10.5
.51	1.39	2.82	4.18	5.53	6.87	8.20	9.53	10.8
.52	1.43	2.90	4.31	5.70	7.08	8.46	9.83	11.2
.53	1.48	2.99	4.44	5.88	7.30	8.72	10.1	11.5
.54	1.52	3.08	4.57	6.05	7.52	8.98	10.4	11.9
.55	1.56	3.17	4.71	6.23	7.74	9.25	10.8	12.2
.56	1.61	3.26	4.84	6.41	7.97	9.52	11.1	12.6
.57	1.65	3.35	4.98	6.59	8.20	9.79	11.4	13.0
.58	1.70	3.44	5.11	6.77	8.43	10.1	11.7	13.3
.59	1.74	3.53	5.25	6.96	8.66	10.3	12.0	13.7

Table A8-12 [continued]. Free-flow discharges in ft³/sec through 1- to 8-foot Parshall flumes. Discharges for 2- to 8-ft flumes computed from the formula $Q=4.00Wh_a^{1.522(W^{0.026})}$. Discharges for 1-ft flume computed from the formula $Q=3.95h_a^{1.55}$.

Upper Head h_a , ft	Discharge for flumes of various throat widths, W							
	1.0	2.0	3.0	4.0	5.0	6.0	7.0	8.0
0.60	1.79	3.62	5.39	7.15	8.89	10.6	12.4	14.1
.61	1.84	3.72	5.53	7.34	9.13	10.9	12.7	14.5
.62	1.88	3.81	5.68	7.53	9.37	11.2	13.0	14.8
.63	1.93	3.91	5.82	7.72	9.61	11.5	13.4	15.2
.64	1.98	4.01	5.97	7.91	9.85	11.8	13.7	15.6
.65	2.03	4.10	6.11	8.11	10.1	12.1	14.0	16.0
.66	2.07	4.20	6.26	8.31	10.3	12.4	14.4	16.4
.67	2.12	4.30	6.41	8.51	10.6	12.7	14.7	16.8
.68	2.17	4.40	6.56	8.71	10.8	13.0	15.1	17.2
.69	2.22	4.50	6.71	8.91	11.1	13.3	15.5	17.6
.70	2.27	4.60	6.86	9.11	11.4	13.6	15.8	18.0
.71	2.32	4.71	7.02	9.32	11.6	13.9	16.2	18.5
.72	2.37	4.81	7.17	9.53	11.9	14.2	16.5	18.9
.73	2.43	4.91	7.33	9.74	12.1	14.5	16.9	19.3
.74	2.48	5.02	7.49	9.95	12.4	14.8	17.3	19.7
.75	2.53	5.12	7.65	10.2	12.7	15.2	17.7	20.2
.76	2.58	5.23	7.81	10.4	12.9	15.5	18.0	20.6
.77	2.63	5.34	7.97	10.6	13.2	15.8	18.4	21.0
.78	2.69	5.44	8.13	10.8	13.5	16.1	18.8	21.5
.79	2.74	5.55	8.30	11.0	13.8	16.5	19.2	21.9
.80	2.80	5.66	8.46	11.3	14.0	16.8	19.6	22.4
.81	2.85	5.77	8.63	11.5	14.3	17.2	20.0	22.8
.82	2.90	5.88	8.79	11.7	14.6	17.5	20.4	23.3
.83	2.96	5.99	8.96	11.9	14.9	17.8	20.8	23.7
.84	3.01	6.11	9.13	12.2	15.2	18.2	21.2	24.2
.85	3.07	6.22	9.30	12.4	15.5	18.5	21.6	24.6
.86	3.13	6.33	9.48	12.6	15.7	18.9	22.0	25.1
.87	3.18	6.45	9.65	12.8	16.0	19.2	22.4	25.6
.88	3.24	6.56	9.82	13.1	16.3	19.6	22.8	26.1
.89	3.30	6.68	10.0	13.3	16.6	19.9	23.2	26.5
.90	3.35	6.79	10.2	13.5	16.9	20.3	23.7	27.0
.91	3.41	6.91	10.4	13.8	17.2	20.6	24.1	27.5
.92	3.47	7.03	10.5	14.0	17.5	21.0	24.5	28.0
.93	3.53	7.15	10.7	14.3	17.8	21.4	24.9	28.5
.94	3.59	7.27	10.9	14.5	18.1	21.7	25.4	29.0
.95	3.65	7.39	11.1	14.8	18.4	22.1	25.8	29.5
.96	3.71	7.51	11.3	15.0	18.7	22.5	26.2	30.0
.97	3.77	7.63	11.4	15.2	19.1	22.9	26.7	30.5
.98	3.83	7.75	11.6	15.5	19.4	23.2	27.1	31.0
.99	3.89	7.88	11.8	15.7	19.7	23.6	27.6	31.5

Table A8-12 [continued]. Free-flow discharges in ft³/sec through 1- to 8-foot Parshall flumes. Discharges for 2- to 8-ft flumes computed from the formula $Q=4.00Wh_a^{1.522(W^{0.026})}$. Discharges for 1-ft flume computed from the formula $Q=3.95h_a^{1.55}$.

Upper Head h_a , ft	Discharge for flumes of various throat widths, W							
	1.0	2.0	3.0	4.0	5.0	6.0	7.0	8.0
1.00	3.95	8.00	12.0	16.0	20.0	24.0	28.0	32.0
1.01	4.01	8.12	12.2	16.3	20.3	24.4	28.4	32.5
1.02	4.07	8.25	12.4	16.5	20.6	24.8	28.9	33.0
1.03	4.14	8.37	12.6	16.8	21.0	25.2	29.4	33.6
1.04	4.20	8.50	12.8	17.0	21.3	25.5	29.8	34.1
1.05	4.26	8.63	13.0	17.3	21.6	25.9	30.3	34.6
1.06	4.32	8.76	13.1	17.5	21.9	26.3	30.7	35.1
1.07	4.39	8.88	13.3	17.8	22.3	26.7	31.2	35.7
1.08	4.45	9.01	13.5	18.1	22.6	27.1	31.7	36.2
1.09	4.51	9.14	13.7	18.3	22.9	27.5	32.1	36.8
1.10	4.58	9.27	13.9	18.6	23.3	27.9	32.6	37.3
1.11	4.64	9.40	14.1	18.9	23.6	28.3	33.1	37.8
1.12	4.71	9.54	14.3	19.1	23.9	28.8	33.6	38.4
1.13	4.77	9.67	14.5	19.4	24.3	29.2	34.1	38.9
1.14	4.84	9.80	14.7	19.7	24.6	29.6	34.5	39.5
1.15	4.91	9.93	14.9	19.9	25.0	30.0	35.0	40.1
1.16	4.97	10.1	15.1	20.2	25.3	30.4	35.5	40.6
1.17	5.04	10.2	15.3	20.5	25.7	30.8	36.0	41.2
1.18	5.11	10.3	15.6	20.8	26.0	31.2	36.5	41.7
1.19	5.17	10.5	15.8	21.1	26.4	31.7	37.0	42.3
1.20	5.24	10.6	16.0	21.3	26.7	32.1	37.5	42.9
1.21	5.31	10.7	16.2	21.6	27.1	32.5	38.0	43.5
1.22	5.38	10.9	16.4	21.9	27.4	33.0	38.5	44.0
1.23	5.44	11.0	16.6	22.2	27.8	33.4	39.0	44.6
1.24	5.51	11.2	16.8	22.5	28.1	33.8	39.5	45.2
1.25	5.58	11.3	17.0	22.8	28.5	34.3	40.0	45.8
1.26	5.65	11.4	17.2	23.0	28.9	34.7	40.5	46.4
1.27	5.72	11.6	17.4	23.3	29.2	35.1	41.1	47.0
1.28	5.79	11.7	17.7	23.6	29.6	35.6	41.6	47.6
1.29	5.86	11.9	17.9	23.9	30.0	36.0	42.1	48.2
1.30	5.93	12.0	18.1	24.2	30.3	36.5	42.6	48.8
1.31	6.00	12.2	18.3	24.5	30.7	36.9	43.1	49.4
1.32	6.07	12.3	18.5	24.8	31.1	37.4	43.7	50.0
1.33	6.15	12.4	18.8	25.1	31.4	37.8	44.2	50.6
1.34	6.22	12.6	19.0	25.4	31.8	38.3	44.7	51.2
1.35	6.29	12.7	19.2	25.7	32.2	38.7	45.3	51.8
1.36	6.36	12.9	19.4	26.0	32.6	39.2	45.8	52.4
1.37	6.43	13.0	19.6	26.3	33.0	39.6	46.3	53.1
1.38	6.51	13.2	19.9	26.6	33.3	40.1	46.9	53.7
1.39	6.58	13.3	20.1	26.9	33.7	40.6	47.4	54.3

Table A8-12 [continued]. Free-flow discharges in ft³/sec through 1- to 8-foot Parshall flumes. Discharges for 2- to 8-ft flumes computed from the formula $Q=4.00Wh_a^{1.522(W^{0.026})}$. Discharges for 1-ft flume computed from the formula $Q=3.95h_a^{1.55}$.

Upper Head h_a , ft	Discharge for flumes of various throat widths, W							
	1.0	2.0	3.0	4.0	5.0	6.0	7.0	8.0
1.40	6.65	13.5	20.3	27.2	34.1	41.0	48.0	54.9
1.41	6.73	13.6	20.6	27.5	34.5	41.5	48.5	55.6
1.42	6.80	13.8	20.8	27.8	34.9	42.0	49.1	56.2
1.43	6.88	13.9	21.0	28.1	35.3	42.5	49.6	56.8
1.44	6.95	14.1	21.2	28.4	35.7	42.9	50.2	57.5
1.45	7.03	14.2	21.5	28.8	36.1	43.4	50.8	58.1
1.46	7.10	14.4	21.7	29.1	36.5	43.9	51.3	58.8
1.47	7.18	14.5	21.9	29.4	36.9	44.4	51.9	59.4
1.48	7.25	14.7	22.2	29.7	37.3	44.8	52.4	60.1
1.49	7.33	14.8	22.4	30.0	37.7	45.3	53.0	60.7
1.50	7.41	15.0	22.6	30.3	38.1	45.8	53.6	61.4
1.51	7.48	15.2	22.9	30.7	38.5	46.3	54.2	62.0
1.52	7.56	15.3	23.1	31.0	38.9	46.8	54.7	62.7
1.53	7.64	15.5	23.4	31.3	39.3	47.3	55.3	63.4
1.54	7.71	15.6	23.6	31.6	39.7	47.8	55.9	64.0
1.55	7.79	15.8	23.8	31.9	40.1	48.3	56.5	64.7
1.56	7.87	15.9	24.1	32.3	40.5	48.8	57.1	65.4
1.57	7.95	16.1	24.3	32.6	40.9	49.3	57.6	66.1
1.58	8.03	16.3	24.6	32.9	41.3	49.8	58.2	66.7
1.59	8.11	16.4	24.8	33.3	41.7	50.3	58.8	67.4
1.60	8.18	16.6	25.1	33.6	42.2	50.8	59.4	68.1
1.61	8.26	16.7	25.3	33.9	42.6	51.3	60.0	68.8
1.62	8.34	16.9	25.5	34.3	43.0	51.8	60.6	69.5
1.63	8.42	17.1	25.8	34.6	43.4	52.3	61.2	70.2
1.64	8.50	17.2	26.0	34.9	43.9	52.8	61.8	70.8
1.65	8.58	17.4	26.3	35.3	44.3	53.3	62.4	71.5
1.66	8.66	17.5	26.5	35.6	44.7	53.9	63.0	72.2
1.67	8.75	17.7	26.8	35.9	45.1	54.4	63.6	72.9
1.68	8.83	17.9	27.0	36.3	45.6	54.9	64.3	73.6
1.69	8.91	18.0	27.3	36.6	46.0	55.4	64.9	74.3
1.70	8.99	18.2	27.5	37.0	46.4	55.9	65.5	75.1
1.71	9.07	18.4	27.8	37.3	46.9	56.5	66.1	75.8
1.72	9.16	18.5	28.1	37.6	47.3	57.0	66.7	76.5
1.73	9.24	18.7	28.3	38.0	47.7	57.5	67.3	77.2
1.74	9.32	18.9	28.6	38.3	48.2	58.0	68.0	77.9
1.75	9.40	19.0	28.8	38.7	48.6	58.6	68.6	78.6
1.76	9.49	19.2	29.1	39.0	49.1	59.1	69.2	79.4
1.77	9.57	19.4	29.3	39.4	49.5	59.7	69.8	80.1
1.78	9.65	19.6	29.6	39.7	49.9	60.2	70.5	80.8
1.79	9.74	19.7	29.9	40.1	50.4	60.7	71.1	81.5

Table A8-12 [continued]. Free-flow discharges in ft³/sec through 1- to 8-foot Parshall flumes. Discharges for 2- to 8-ft flumes computed from the formula $Q=4.00Wh_a^{1.522(W^{0.026})}$. Discharges for 1-ft flume computed from the formula $Q=3.95h_a^{1.55}$.

Upper Head h_a , ft	Discharge for flumes of various throat widths, W							
	1.0	2.0	3.0	4.0	5.0	6.0	7.0	8.0
1.80	9.82	19.9	30.1	40.4	50.8	61.3	71.8	82.3
1.81	9.91	20.1	30.4	40.8	51.3	61.8	72.4	83.0
1.82	9.99	20.2	30.7	41.2	51.7	62.4	73.0	83.7
1.83	10.1	20.4	30.9	41.5	52.2	62.9	73.7	84.5
1.84	10.2	20.6	31.2	41.9	52.6	63.5	74.3	85.2
1.85	10.2	20.8	31.4	42.2	53.1	64.0	75.0	86.0
1.86	10.3	20.9	31.7	42.6	53.5	64.6	75.6	86.7
1.87	10.4	21.1	32.0	43.0	54.0	65.1	76.3	87.5
1.88	10.5	21.3	32.3	43.3	54.5	65.7	76.9	88.2
1.89	10.6	21.5	32.5	43.7	54.9	66.2	77.6	89.0
1.90	10.7	21.6	32.8	44.1	55.4	66.8	78.2	89.7
1.91	10.8	21.8	33.1	44.4	55.9	67.4	78.9	90.5
1.92	10.9	22.0	33.3	44.8	56.3	67.9	79.6	91.3
1.93	10.9	22.2	33.6	45.2	56.8	68.5	80.2	92.0
1.94	11.0	22.3	33.9	45.5	57.3	69.0	80.9	92.8
1.95	11.1	22.5	34.2	45.9	57.7	69.6	81.6	93.6
1.96	11.2	22.7	34.4	46.3	58.2	70.2	82.2	94.3
1.97	11.3	22.9	34.7	46.6	58.7	70.8	82.9	95.1
1.98	11.4	23.1	35.0	47.0	59.1	71.3	83.6	95.9
1.99	11.5	23.2	35.3	47.4	59.6	71.9	84.3	96.7
2.00	11.6	23.4	35.5	47.8	60.1	72.5	84.9	97.4
2.01	11.7	23.6	35.8	48.1	60.6	73.1	85.6	98.2
2.02	11.7	23.8	36.1	48.5	61.0	73.6	86.3	99.0
2.03	11.8	24.0	36.4	48.9	61.5	74.2	87.0	99.8
2.04	11.9	24.1	36.7	49.3	62.0	74.8	87.7	101.
2.05	12.0	24.3	36.9	49.7	62.5	75.4	88.4	101.
2.06	12.1	24.5	37.2	50.0	63.0	76.0	89.1	102.
2.07	12.2	24.7	37.5	50.4	63.5	76.6	89.7	103.
2.08	12.3	24.9	37.8	50.8	63.9	77.2	90.4	104.
2.09	12.4	25.1	38.1	51.2	64.4	77.8	91.1	105.
2.10	12.5	25.3	38.4	51.6	64.9	78.3	91.8	105.
2.11	12.6	25.4	38.6	52.0	65.4	78.9	92.5	106.
2.12	12.7	25.6	38.9	52.4	65.9	79.5	93.2	107.
2.13	12.8	25.8	39.2	52.8	66.4	80.1	93.9	108.
2.14	12.8	26.0	39.5	53.1	66.9	80.7	94.7	109.
2.15	12.9	26.2	39.8	53.5	67.4	81.3	95.4	109.
2.16	13.0	26.4	40.1	53.9	67.9	81.9	96.1	110.
2.17	13.1	26.6	40.4	54.3	68.4	82.6	96.8	111.
2.18	13.2	26.8	40.7	54.7	68.9	83.2	97.5	112.
2.19	13.3	27.0	41.0	55.1	69.4	83.8	98.2	113.

Table A8-12 [continued]. Free-flow discharges in ft³/sec through 1- to 8-foot Parshall flumes. Discharges for 2- to 8-ft flumes computed from the formula $Q=4.00Wh_a^{1.522(W^{0.026})}$. Discharges for 1-ft flume computed from the formula $Q=3.95h_a^{1.55}$.

Upper Head h_a , ft	Discharge for flumes of various throat widths, W							
	1.0	2.0	3.0	4.0	5.0	6.0	7.0	8.0
2.20	13.4	27.1	41.3	55.5	69.9	84.4	98.9	114.
2.21	13.5	27.3	41.5	55.9	70.4	85.0	99.7	114.
2.22	13.6	27.5	41.8	56.3	70.9	85.6	100.	115.
2.23	13.7	27.7	42.1	56.7	71.4	86.2	101.	116.
2.24	13.8	27.9	42.4	57.1	71.9	86.8	102.	117.
2.25	13.9	28.1	42.7	57.5	72.4	87.5	103.	118.
2.26	14.0	28.3	43.0	57.9	72.9	88.1	103.	119.
2.27	14.1	28.5	43.3	58.3	73.5	88.7	104.	119.
2.28	14.2	28.7	43.6	58.7	74.0	89.3	105.	120.
2.29	14.3	28.9	43.9	59.1	74.5	89.9	105.	121.
2.30	14.4	29.1	44.2	59.5	75.0	90.6	106.	122.
2.31	14.5	29.3	44.5	60.0	75.5	91.2	107.	123.
2.32	14.6	29.5	44.8	60.4	76.0	91.8	108.	124.
2.33	14.7	29.7	45.1	60.8	76.6	92.5	108.	125.
2.34	14.8	29.9	45.4	61.2	77.1	93.1	109.	125.
2.35	14.9	30.1	45.7	61.6	77.6	93.7	110.	126.
2.36	14.9	30.3	46.0	62.0	78.1	94.4	111.	127.
2.37	15.0	30.5	46.4	62.4	78.7	95.0	111.	128.
2.38	15.1	30.7	46.7	62.9	79.2	95.7	112.	129.
2.39	15.2	30.9	47.0	63.3	79.7	96.3	113.	130.
2.40	15.3	31.1	47.3	63.7	80.2	96.9	114.	131.
2.41	15.4	31.3	47.6	64.1	80.8	97.6	114.	131.
2.42	15.5	31.5	47.9	64.5	81.3	98.2	115.	132.
2.43	15.6	31.7	48.2	64.9	81.8	98.9	116.	133.
2.44	15.7	31.9	48.5	65.4	82.4	99.5	117.	134.
2.45	15.8	32.1	48.8	65.8	82.9	100.	118.	135.
2.46	15.9	32.3	49.1	66.2	83.5	101.	118.	136.
2.47	16.0	32.5	49.5	66.6	84.0	101.	119.	137.
2.48	16.1	32.7	49.8	67.1	84.5	102.	120.	138.
2.49	16.2	32.9	50.1	67.5	85.1	103.	121.	139.
2.50	16.3	33.1	50.4	67.9	85.6	103.	121.	139.

Table A8-13. Free-flow discharge through 10-ft Parshall measuring flume
in ft³/sec. Computed from the formula $Q=39.38h_a^{1.6}$.

Upper Head h_a , ft	Hundredths									
	0.00	0.01	0.02	0.03	0.04	0.05	0.06	0.07	0.08	0.09
0.10	0.99	1.15	1.32	1.51	1.69	1.89	2.10	2.31	2.53	2.76
.20	3.00	3.24	3.49	3.75	4.01	4.29	4.56	4.85	5.14	5.43
.30	5.74	6.05	6.36	6.68	7.01	7.34	7.68	8.02	8.37	8.73
.40	9.09	9.46	9.83	10.2	10.6	11.0	11.4	11.8	12.2	12.6
.50	13.0	13.4	13.8	14.3	14.7	15.1	15.6	16.0	16.5	16.9
.60	17.4	17.9	18.3	18.8	19.3	19.8	20.3	20.7	21.2	21.7
.70	22.3	22.8	23.3	23.8	24.3	24.9	25.4	25.9	26.5	27.0
.80	27.6	28.1	28.7	29.2	29.8	30.4	30.9	31.5	32.1	32.7
.90	33.3	33.9	34.5	35.1	35.7	36.3	36.9	37.5	38.1	38.8
1.00	39.4	40.0	40.6	41.3	41.9	42.6	43.2	43.9	44.5	45.2
1.10	45.9	46.5	47.2	47.9	48.6	49.2	49.9	50.6	51.3	52.0
1.20	52.7	53.4	54.1	54.8	55.6	56.3	57.0	57.7	58.5	59.2
1.30	59.9	60.7	61.4	62.1	62.9	63.7	64.4	65.2	65.9	66.7
1.40	67.5	68.2	69.0	69.8	70.6	71.4	72.2	72.9	73.7	74.5
1.50	75.3	76.1	77.0	77.8	78.6	79.4	80.2	81.0	81.9	82.7
1.60	83.5	84.4	85.2	86.1	86.9	87.8	88.6	89.5	90.3	91.2
1.70	92.0	92.9	93.8	94.7	95.5	96.4	97.3	98.2	99.1	100.
1.80	101.	102.	103.	104.	104.	105.	106.	107.	108.	109.
1.90	110.	111.	112.	113.	114.	115.	116.	117.	117.	118.
2.00	119.	120.	121.	122.	123.	124.	125.	126.	127.	128.
2.10	129.	130.	131.	132.	133.	134.	135.	136.	137.	138.
2.20	139.	140.	141.	142.	143.	144.	145.	146.	147.	148.
2.30	149.	150.	151.	152.	153.	155.	156.	157.	158.	159.
2.40	160.	161.	162.	163.	164.	165.	166.	167.	168.	170.
2.50	171.	172.	173.	174.	175.	176.	177.	178.	179.	181.
2.60	182.	183.	184.	185.	186.	187.	188.	190.	191.	192.
2.70	193.	194.	195.	196.	198.	199.	200.	201.	202.	203.
2.80	205.	206.	207.	208.	209.	210.	212.	213.	214.	215.
2.90	216.	218.	219.	220.	221.	222.	224.	225.	226.	227.
3.00	228.	230.	231.	232.	233.	235.	236.	237.	238.	239.
3.10	241.	242.	243.	244.	246.	247.	248.	249.	251.	252.
3.20	253.	254.	256.	257.	258.	260.	261.	262.	263.	265.
3.30	266.	267.	269.	270.	271.	272.	274.	275.	276.	278.
3.40	279.	280.	282.	283.	284.	286.	287.	288.	290.	291.
3.50	292.	294.	295.	296.	298.	299.	300.	302.	303.	304.
3.60	306.	307.	308.	310.	311.	313.	314.	315.	317.	318.
3.70	319.	321.	322.	324.	325.	326.	328.	329.	331.	332.
3.80	333.	335.	336.	338.	339.	340.	342.	343.	345.	346.
3.90	348.	349.	350.	352.	353.	355.	356.	358.	359.	360.
4.00	362.	363.	365.	366.	368.	369.	371.	372.	374.	375.
4.10	376.	378.	379.	381.	382.	384.	385.	387.	388.	390.
4.20	391.	393.	394.	396.	397.	399.	400.	402.	403.	405.
4.30	406.	408.	409.	411.	412.	414.	415.	417.	418.	420.
4.40	422.	423.	425.	426.	428.	429.	431.	432.	434.	435.
4.50	437.	438.	440.	442.	443.	445.	446.	448.	449.	451.
4.60	453.	454.	456.	457.	459.	460.	462.	464.	465.	467.
4.70	468.	470.	472.	473.	475.	476.	478.	480.	481.	483.
4.80	484.	486.	488.	489.	491.	493.	494.	496.	497.	499.
4.90	501.	502.	504.	506.	507.	509.	511.	512.	514.	516.
5.00	517.	519.	520.	522.	524.	525.	527.	529.	530.	532.

Table A8-14. Free-flow discharge through 12-ft Parshall measuring flume
in ft³/sec. Computed from the formula $Q=46.75h_a^{1.6}$.

Upper Head h_a , ft	Hundredths									
	0.00	0.01	0.02	0.03	0.04	0.05	0.06	0.07	0.08	0.09
0.10	1.17	1.37	1.57	1.79	2.01	2.25	2.49	2.74	3.01	3.28
.20	3.56	3.85	4.15	4.45	4.77	5.09	5.42	5.75	6.10	6.45
.30	6.81	7.18	7.55	7.93	8.32	8.72	9.12	9.53	9.94	10.4
.40	10.8	11.2	11.7	12.1	12.6	13.0	13.5	14.0	14.4	14.9
.50	15.4	15.9	16.4	16.9	17.4	18.0	18.5	19.0	19.6	20.1
.60	20.6	21.2	21.8	22.3	22.9	23.5	24.0	24.6	25.2	25.8
.70	26.4	27.0	27.6	28.3	28.9	29.5	30.1	30.8	31.4	32.1
.80	32.7	33.4	34.0	34.7	35.4	36.0	36.7	37.4	38.1	38.8
.90	39.5	40.2	40.9	41.6	42.3	43.1	43.8	44.5	45.3	46.0
1.00	46.8	47.5	48.3	49.0	49.8	50.5	51.3	52.1	52.9	53.7
1.10	54.5	55.2	56.0	56.8	57.7	58.5	59.3	60.1	60.9	61.8
1.20	62.6	63.4	64.3	65.1	66.0	66.8	67.7	68.5	69.4	70.3
1.30	71.1	72.0	72.9	73.8	74.7	75.6	76.5	77.4	78.3	79.2
1.40	80.1	81.0	81.9	82.9	83.8	84.7	85.7	86.6	87.5	88.5
1.50	89.4	90.4	91.4	92.3	93.3	94.3	95.2	96.2	97.2	98.2
1.60	99.2	100.	101.	102.	103.	104.	105.	106.	107.	108.
1.70	109.	110.	111.	112.	113.	114.	116.	117.	118.	119.
1.80	120.	121.	122.	123.	124.	125.	126.	127.	128.	129.
1.90	131.	132.	133.	134.	135.	136.	137.	138.	139.	141.
2.00	142.	143.	144.	145.	146.	147.	149.	150.	151.	152.
2.10	153.	154.	156.	157.	158.	159.	160.	161.	163.	164.
2.20	165.	166.	167.	169.	170.	171.	172.	174.	175.	176.
2.30	177.	178.	180.	181.	182.	183.	185.	186.	187.	188.
2.40	190.	191.	192.	194.	195.	196.	197.	199.	200.	201.
2.50	203.	204.	205.	206.	208.	209.	210.	212.	213.	214.
2.60	216.	217.	218.	220.	221.	222.	224.	225.	226.	228.
2.70	229.	230.	232.	233.	235.	236.	237.	239.	240.	241.
2.80	243.	244.	246.	247.	248.	250.	251.	253.	254.	255.
2.90	257.	258.	260.	261.	263.	264.	265.	267.	268.	270.
3.00	271.	273.	274.	275.	277.	278.	280.	281.	283.	284.
3.10	286.	287.	289.	290.	292.	293.	295.	296.	298.	299.
3.20	301.	302.	304.	305.	307.	308.	310.	311.	313.	314.
3.30	316.	317.	319.	320.	322.	323.	325.	327.	328.	330.
3.40	331.	333.	334.	336.	338.	339.	341.	342.	344.	345.
3.50	347.	349.	350.	352.	353.	355.	357.	358.	360.	361.
3.60	363.	365.	366.	368.	369.	371.	373.	374.	376.	378.
3.70	379.	381.	383.	384.	386.	387.	389.	391.	392.	394.
3.80	396.	397.	399.	401.	402.	404.	406.	407.	409.	411.
3.90	413.	414.	416.	418.	419.	421.	423.	424.	426.	428.
4.00	430.	431.	433.	435.	437.	438.	440.	442.	443.	445.
4.10	447.	449.	450.	452.	454.	456.	457.	459.	461.	463.
4.20	464.	466.	468.	470.	472.	473.	475.	477.	479.	481.
4.30	482.	484.	486.	488.	490.	491.	493.	495.	497.	499.
4.40	500.	502.	504.	506.	508.	510.	511.	513.	515.	517.
4.50	519.	521.	522.	524.	526.	528.	530.	532.	534.	535.
4.60	537.	539.	541.	543.	545.	547.	549.	550.	552.	554.
4.70	556.	558.	560.	562.	564.	566.	567.	569.	571.	573.
4.80	575.	577.	579.	581.	583.	585.	587.	589.	591.	592.
4.90	594.	596.	598.	600.	602.	604.	606.	608.	610.	612.
5.00	614.	616.	618.	620.	622.	624.	626.	628.	630.	632.

Table A8-15. Free-flow discharge through 15-ft Parshall measuring flume in ft³/sec.
 Computed from the formula $Q=57.81h_a^{1.6}$.

Upper Head h_a , ft	Hundredths									
	0.00	0.01	0.02	0.03	0.04	0.05	0.06	0.07	0.08	0.09
0.30	8.42	8.88	9.34	9.81	10.3	10.8	11.3	11.8	12.3	12.8
.40	13.3	13.9	14.4	15.0	15.5	16.1	16.7	17.3	17.9	18.5
.50	19.1	19.7	20.3	20.9	21.6	22.2	22.9	23.5	24.2	24.9
.60	25.5	26.2	26.9	27.6	28.3	29.0	29.7	30.5	31.2	31.9
.70	32.7	33.4	34.2	34.9	35.7	36.5	37.3	38.1	38.8	39.6
.80	40.5	41.3	42.1	42.9	43.7	44.6	45.4	46.3	47.1	48.0
.90	48.8	49.7	50.6	51.5	52.4	53.3	54.2	55.1	56.0	56.9
1.00	57.8	58.7	59.7	60.6	61.6	62.5	63.5	64.4	65.4	66.4
1.10	67.3	68.3	69.3	70.3	71.3	72.3	73.3	74.3	75.3	76.4
1.20	77.4	78.4	79.5	80.5	81.6	82.6	83.7	84.7	85.8	86.9
1.30	88.0	89.1	90.1	91.2	92.3	93.4	94.6	95.7	96.8	97.9
1.40	99.0	100.	101.	102.	104.	105.	106.	107.	108.	109.
1.50	111.	112.	113.	114.	115.	117.	118.	119.	120.	121.
1.60	123.	124.	125.	126.	128.	129.	130.	131.	133.	134.
1.70	135.	136.	138.	139.	140.	142.	143.	144.	145.	147.
1.80	148.	149.	151.	152.	153.	155.	156.	157.	159.	160.
1.90	161.	163.	164.	166.	167.	168.	170.	171.	172.	174.
2.00	175.	177.	178.	179.	181.	182.	184.	185.	187.	188.
2.10	189.	191.	192.	194.	195.	197.	198.	200.	201.	203.
2.20	204.	206.	207.	209.	210.	212.	213.	215.	216.	218.
2.30	219.	221.	222.	224.	225.	227.	228.	230.	231.	233.
2.40	235.	236.	238.	239.	241.	242.	244.	246.	247.	249.
2.50	250.	252.	254.	255.	257.	259.	260.	262.	263.	265.
2.60	267.	268.	270.	272.	273.	275.	277.	278.	280.	282.
2.70	283.	285.	287.	288.	290.	292.	293.	295.	297.	299.
2.80	300.	302.	304.	305.	307.	309.	311.	312.	314.	316.
2.90	318.	319.	321.	323.	325.	326.	328.	330.	332.	333.
3.00	335.	337.	339.	341.	342.	344.	346.	348.	350.	352.
3.10	353.	355.	357.	359.	361.	362.	364.	366.	368.	370.
3.20	372.	374.	375.	377.	379.	381.	383.	385.	387.	389.
3.30	391.	392.	394.	396.	398.	400.	402.	404.	406.	408.
3.40	410.	412.	413.	415.	417.	419.	421.	423.	425.	427.
3.50	429.	431.	433.	435.	437.	439.	441.	443.	445.	447.
3.60	449.	451.	453.	455.	457.	459.	461.	463.	465.	467.
3.70	469.	471.	473.	475.	477.	479.	481.	483.	485.	487.
3.80	489.	491.	494.	496.	498.	500.	502.	504.	506.	508.
3.90	510.	512.	514.	516.	519.	521.	523.	525.	527.	529.
4.00	531.	533.	536.	538.	540.	542.	544.	546.	548.	551.
4.10	553.	555.	557.	559.	561.	563.	566.	568.	570.	572.
4.20	574.	577.	579.	581.	583.	585.	588.	590.	592.	594.
4.30	596.	599.	601.	603.	605.	608.	610.	612.	614.	617.
4.40	619.	621.	623.	626.	628.	630.	632.	635.	637.	639.
4.50	641.	644.	646.	648.	651.	653.	655.	657.	660.	662.
4.60	664.	667.	669.	671.	674.	676.	678.	681.	683.	685.
4.70	688.	690.	692.	695.	697.	699.	702.	704.	706.	709.
4.80	711.	714.	716.	718.	721.	723.	725.	728.	730.	733.
4.90	735.	737.	740.	742.	745.	747.	750.	752.	754.	757.
5.00	759.	762.	764.	766.	769.	771.	774.	776.	779.	781.
5.10	784.	786.	789.	791.	793.	796.	798.	801.	803.	806.
5.20	808.	811.	813.	816.	818.	821.	823.	826.	828.	831.
5.30	833.	836.	838.	841.	843.	846.	849.	851.	854.	856.
5.40	859.	861.	864.	866.	869.	871.	874.	877.	879.	882.
5.50	884.	887.	889.	892.	895.	897.	900.	902.	905.	908.
5.60	910.	913.	915.	918.	921.	923.	926.	928.	931.	934.
5.70	936.	939.	942.	944.	947.	949.	952.	955.	957.	960.
5.80	963.	965.	968.	971.	973.	976.	979.	981.	984.	987.
5.90	989.	992.	995.	997.	1000.	1003.	1006.	1008.	1011.	1014.
6.00	1016.	1019.	1022.	1024.	1027.	1030.	1033.	1035.	1038.	1041.

Table A8-16. Free-flow discharge through 20-ft Parshall measuring flume in ft³/sec.
 Computed from the formula $Q=76.25h_a^{1.6}$.

Upper Head h_a , ft	Hundredths									
	0.00	0.01	0.02	0.03	0.04	0.05	0.06	0.07	0.08	0.09
0.30	11.1	11.7	12.3	12.9	13.6	14.2	14.9	15.5	16.2	16.9
.40	17.6	18.3	19.0	19.8	20.5	21.3	22.0	22.8	23.6	24.4
.50	25.2	26.0	26.8	27.6	28.4	29.3	30.2	31.0	31.9	32.8
.60	33.7	34.6	35.5	36.4	37.3	38.3	39.2	40.2	41.1	42.1
.70	43.1	44.1	45.1	46.1	47.1	48.1	49.2	50.2	51.2	52.3
.80	53.4	54.4	55.5	56.6	57.7	58.8	59.9	61.0	62.1	63.3
.90	64.4	65.6	66.7	67.9	69.1	70.2	71.4	72.6	73.8	75.0
1.00	76.3	77.5	78.7	79.9	81.2	82.4	83.7	85.0	86.2	87.5
1.10	88.8	90.1	91.4	92.7	94.0	95.4	96.7	98.0	99.4	101.
1.20	102.	103.	105.	106.	108.	109.	110.	112.	113.	115.
1.30	116.	117.	119.	120.	122.	123.	125.	126.	128.	129.
1.40	131.	132.	134.	135.	137.	138.	140.	141.	143.	144.
1.50	146.	147.	149.	151.	152.	154.	155.	157.	159.	160.
1.60	162.	163.	165.	167.	168.	170.	172.	173.	175.	177.
1.70	178.	180.	182.	183.	185.	187.	188.	190.	192.	194.
1.80	195.	197.	199.	201.	202.	204.	206.	208.	209.	211.
1.90	213.	215.	217.	218.	220.	222.	224.	226.	227.	229.
2.00	231.	233.	235.	237.	239.	240.	242.	244.	246.	248.
2.10	250.	252.	254.	256.	258.	260.	261.	263.	265.	267.
2.20	269.	271.	273.	275.	277.	279.	281.	283.	285.	287.
2.30	289.	291.	293.	295.	297.	299.	301.	303.	305.	307.
2.40	309.	312.	314.	316.	318.	320.	322.	324.	326.	328.
2.50	330.	332.	335.	337.	339.	341.	343.	345.	347.	350.
2.60	352.	354.	356.	358.	360.	363.	365.	367.	369.	371.
2.70	374.	376.	378.	380.	383.	385.	387.	389.	391.	394.
2.80	396.	398.	401.	403.	405.	407.	410.	412.	414.	417.
2.90	419.	421.	423.	426.	428.	430.	433.	435.	438.	440.
3.00	442.	445.	447.	449.	452.	454.	456.	459.	461.	464.
3.10	466.	468.	471.	473.	476.	478.	481.	483.	485.	488.
3.20	490.	493.	495.	498.	500.	503.	505.	508.	510.	513.
3.30	515.	518.	520.	523.	525.	528.	530.	533.	535.	538.
3.40	540.	543.	545.	548.	550.	553.	556.	558.	561.	563.
3.50	566.	569.	571.	574.	576.	579.	582.	584.	587.	589.
3.60	592.	595.	597.	600.	603.	605.	608.	611.	613.	616.
3.70	619.	621.	624.	627.	629.	632.	635.	637.	640.	643.
3.80	645.	648.	651.	654.	656.	659.	662.	665.	667.	670.
3.90	673.	676.	678.	681.	684.	687.	690.	692.	695.	698.
4.00	701.	704.	706.	709.	712.	715.	718.	720.	723.	726.
4.10	729.	732.	735.	737.	740.	743.	746.	749.	752.	755.
4.20	758.	760.	763.	766.	769.	772.	775.	778.	781.	784.
4.30	787.	790.	793.	795.	798.	801.	804.	807.	810.	813.
4.40	816.	819.	822.	825.	828.	831.	834.	837.	840.	843.
4.50	846.	849.	852.	855.	858.	861.	864.	867.	870.	873.
4.60	876.	879.	882.	885.	889.	892.	895.	898.	901.	904.
4.70	907.	910.	913.	916.	919.	922.	926.	929.	932.	935.
4.80	938.	941.	944.	947.	951.	954.	957.	960.	963.	966.
4.90	970.	973.	976.	979.	982.	985.	989.	992.	995.	998.
5.00	1001.	1005.	1008.	1011.	1014.	1017.	1021.	1024.	1027.	1030.
5.10	1034.	1037.	1040.	1043.	1047.	1050.	1053.	1056.	1060.	1063.
5.20	1066.	1069.	1073.	1076.	1079.	1083.	1086.	1089.	1093.	1096.
5.30	1099.	1103.	1106.	1109.	1113.	1116.	1119.	1123.	1126.	1129.
5.40	1133.	1136.	1139.	1143.	1146.	1149.	1153.	1156.	1160.	1163.
5.50	1166.	1170.	1173.	1177.	1180.	1183.	1187.	1190.	1194.	1197.
5.60	1200.	1204.	1207.	1211.	1214.	1218.	1221.	1225.	1228.	1231.
5.70	1235.	1238.	1242.	1245.	1249.	1252.	1256.	1259.	1263.	1266.
5.80	1270.	1273.	1277.	1280.	1284.	1287.	1291.	1294.	1298.	1301.
5.90	1305.	1309.	1312.	1316.	1319.	1323.	1326.	1330.	1333.	1337.
6.00	1341.	1344.	1348.	1351.	1355.	1358.	1362.	1366.	1369.	1373.

Table A8-17. Free-flow discharge through 25-ft Parshall measuring flume in ft³/sec.
 Computed from the formula $Q=94.69h_a^{1.6}$.

Upper Head h_a , ft	Hundredths									
	0.00	0.01	0.02	0.03	0.04	0.05	0.06	0.07	0.08	0.09
0.30	13.8	14.5	15.3	16.1	16.9	17.7	18.5	19.3	20.1	21.0
.40	21.9	22.7	23.6	24.5	25.5	26.4	27.3	28.3	29.3	30.2
.50	31.2	32.2	33.3	34.3	35.3	36.4	37.4	38.5	39.6	40.7
.60	41.8	42.9	44.1	45.2	46.4	47.5	48.7	49.9	51.1	52.3
.70	53.5	54.7	56.0	57.2	58.5	59.8	61.0	62.3	63.6	64.9
.80	66.3	67.6	68.9	70.3	71.6	73.0	74.4	75.8	77.2	78.6
.90	80.0	81.4	82.9	84.3	85.8	87.2	88.7	90.2	91.7	93.2
1.00	94.7	96.2	97.7	99.3	101.	102.	104.	106.	107.	109.
1.10	110.	112.	114.	115.	117.	118.	120.	122.	123.	125.
1.20	127.	128.	130.	132.	134.	135.	137.	139.	141.	142.
1.30	144.	146.	148.	149.	151.	153.	155.	157.	159.	160.
1.40	162.	164.	166.	168.	170.	172.	173.	175.	177.	179.
1.50	181.	183.	185.	187.	189.	191.	193.	195.	197.	199.
1.60	201.	203.	205.	207.	209.	211.	213.	215.	217.	219.
1.70	221.	223.	226.	228.	230.	232.	234.	236.	238.	240.
1.80	243.	245.	247.	249.	251.	253.	256.	258.	260.	262.
1.90	264.	267.	269.	271.	273.	276.	278.	280.	282.	285.
2.00	287.	289.	292.	294.	296.	299.	301.	303.	306.	308.
2.10	310.	313.	315.	317.	320.	322.	325.	327.	329.	332.
2.20	334.	337.	339.	342.	344.	347.	349.	352.	354.	356.
2.30	359.	361.	364.	366.	369.	372.	374.	377.	379.	382.
2.40	384.	387.	389.	392.	395.	397.	400.	402.	405.	408.
2.50	410.	413.	415.	418.	421.	423.	426.	429.	431.	434.
2.60	437.	439.	442.	445.	448.	450.	453.	456.	458.	461.
2.70	464.	467.	469.	472.	475.	478.	481.	483.	486.	489.
2.80	492.	495.	497.	500.	503.	506.	509.	512.	514.	517.
2.90	520.	523.	526.	529.	532.	535.	537.	540.	543.	546.
3.00	549.	552.	555.	558.	561.	564.	567.	570.	573.	576.
3.10	579.	582.	585.	588.	591.	594.	597.	600.	603.	606.
3.20	609.	612.	615.	618.	621.	624.	627.	630.	633.	637.
3.30	640.	643.	646.	649.	652.	655.	658.	661.	665.	668.
3.40	671.	674.	677.	680.	684.	687.	690.	693.	696.	700.
3.50	703.	706.	709.	712.	716.	719.	722.	725.	729.	732.
3.60	735.	738.	742.	745.	748.	752.	755.	758.	761.	765.
3.70	768.	771.	775.	778.	781.	785.	788.	791.	795.	798.
3.80	802.	805.	808.	812.	815.	819.	822.	825.	829.	832.
3.90	836.	839.	842.	846.	849.	853.	856.	860.	863.	867.
4.00	870.	874.	877.	881.	884.	888.	891.	895.	898.	902.
4.10	905.	909.	912.	916.	919.	923.	927.	930.	934.	937.
4.20	941.	944.	948.	952.	955.	959.	962.	966.	970.	973.
4.30	977.	981.	984.	988.	991.	995.	999.	1002.	1006.	1010.
4.40	1014.	1017.	1021.	1025.	1028.	1032.	1036.	1039.	1043.	1047.
4.50	1051.	1054.	1058.	1062.	1066.	1069.	1073.	1077.	1081.	1084.
4.60	1088.	1092.	1096.	1100.	1103.	1107.	1111.	1115.	1119.	1122.
4.70	1126.	1130.	1134.	1138.	1142.	1146.	1149.	1153.	1157.	1161.
4.80	1165.	1169.	1173.	1177.	1180.	1184.	1188.	1192.	1196.	1200.
4.90	1204.	1208.	1212.	1216.	1220.	1224.	1228.	1232.	1236.	1240.
5.00	1244.	1248.	1251.	1255.	1259.	1263.	1267.	1272.	1276.	1280.
5.10	1284.	1288.	1292.	1296.	1300.	1304.	1308.	1312.	1316.	1320.
5.20	1324.	1328.	1332.	1336.	1340.	1344.	1349.	1353.	1357.	1361.
5.30	1365.	1369.	1373.	1377.	1382.	1386.	1390.	1394.	1398.	1402.
5.40	1406.	1411.	1415.	1419.	1423.	1427.	1432.	1436.	1440.	1444.
5.50	1448.	1453.	1457.	1461.	1465.	1470.	1474.	1478.	1482.	1486.
5.60	1491.	1495.	1499.	1504.	1508.	1512.	1516.	1521.	1525.	1529.
5.70	1534.	1538.	1542.	1547.	1551.	1555.	1559.	1564.	1568.	1572.
5.80	1577.	1581.	1586.	1590.	1594.	1599.	1603.	1607.	1612.	1616.
5.90	1621.	1625.	1629.	1634.	1638.	1643.	1647.	1651.	1656.	1660.
6.00	1665.	1669.	1674.	1678.	1683.	1687.	1691.	1696.	1700.	1705.

Table A8-18. Free-flow discharge through 30-ft Parshall measuring flume in ft³/sec.
 Computed from the formula $Q=113.13h_a^{1.6}$.

Upper Head h_a , ft	Hundredths									
	0.00	0.01	0.02	0.03	0.04	0.05	0.06	0.07	0.08	0.09
0.30	16.5	17.4	18.3	19.2	20.1	21.1	22.1	23.1	24.1	25.1
.40	26.1	27.2	28.2	29.3	30.4	31.5	32.7	33.8	35.0	36.1
.50	37.3	38.5	39.7	41.0	42.2	43.5	44.7	46.0	47.3	48.6
.60	50.0	51.3	52.7	54.0	55.4	56.8	58.2	59.6	61.0	62.5
.70	63.9	65.4	66.9	68.4	69.9	71.4	72.9	74.5	76.0	77.6
.80	79.2	80.8	82.4	84.0	85.6	87.2	88.9	90.5	92.2	93.9
.90	95.6	97.3	99.0	101.	102.	104.	106.	108.	110.	111.
1.00	113.	115.	117.	119.	120.	122.	124.	126.	128.	130.
1.10	132.	134.	136.	138.	140.	141.	143.	145.	147.	149.
1.20	151.	153.	156.	158.	160.	162.	164.	166.	168.	170.
1.30	172.	174.	176.	179.	181.	183.	185.	187.	189.	192.
1.40	194.	196.	198.	201.	203.	205.	207.	210.	212.	214.
1.50	216.	219.	221.	223.	226.	228.	230.	233.	235.	238.
1.60	240.	242.	245.	247.	250.	252.	255.	257.	259.	262.
1.70	264.	267.	269.	272.	274.	277.	280.	282.	285.	287.
1.80	290.	292.	295.	298.	300.	303.	305.	308.	311.	313.
1.90	316.	319.	321.	324.	327.	329.	332.	335.	337.	340.
2.00	343.	346.	348.	351.	354.	357.	360.	362.	365.	368.
2.10	371.	374.	376.	379.	382.	385.	388.	391.	394.	397.
2.20	399.	402.	405.	408.	411.	414.	417.	420.	423.	426.
2.30	429.	432.	435.	438.	441.	444.	447.	450.	453.	456.
2.40	459.	462.	465.	468.	471.	475.	478.	481.	484.	487.
2.50	490.	493.	496.	500.	503.	506.	509.	512.	515.	519.
2.60	522.	525.	528.	532.	535.	538.	541.	544.	548.	551.
2.70	554.	558.	561.	564.	568.	571.	574.	577.	581.	584.
2.80	588.	591.	594.	598.	601.	604.	608.	611.	615.	618.
2.90	621.	625.	628.	632.	635.	639.	642.	646.	649.	653.
3.00	656.	660.	663.	667.	670.	674.	677.	681.	684.	688.
3.10	691.	695.	699.	702.	706.	709.	713.	717.	720.	724.
3.20	727.	731.	735.	738.	742.	746.	749.	753.	757.	760.
3.30	764.	768.	772.	775.	779.	783.	787.	790.	794.	798.
3.40	802.	805.	809.	813.	817.	821.	824.	828.	832.	836.
3.50	840.	843.	847.	851.	855.	859.	863.	867.	871.	874.
3.60	878.	882.	886.	890.	894.	898.	902.	906.	910.	914.
3.70	918.	922.	926.	930.	934.	938.	942.	946.	950.	954.
3.80	958.	962.	966.	970.	974.	978.	982.	986.	990.	994.
3.90	998.	1002.	1007.	1011.	1015.	1019.	1023.	1027.	1031.	1035.
4.00	1040.	1044.	1048.	1052.	1056.	1060.	1065.	1069.	1073.	1077.
4.10	1082.	1086.	1090.	1094.	1098.	1103.	1107.	1111.	1115.	1120.
4.20	1124.	1128.	1133.	1137.	1141.	1146.	1150.	1154.	1158.	1163.
4.30	1167.	1171.	1176.	1180.	1185.	1189.	1193.	1198.	1202.	1206.
4.40	1211.	1215.	1220.	1224.	1229.	1233.	1237.	1242.	1246.	1251.
4.50	1255.	1260.	1264.	1269.	1273.	1278.	1282.	1287.	1291.	1296.
4.60	1300.	1305.	1309.	1314.	1318.	1323.	1327.	1332.	1337.	1341.
4.70	1346.	1350.	1355.	1359.	1364.	1369.	1373.	1378.	1382.	1387.
4.80	1392.	1396.	1401.	1406.	1410.	1415.	1420.	1424.	1429.	1434.
4.90	1438.	1443.	1448.	1453.	1457.	1462.	1467.	1471.	1476.	1481.
5.00	1486.	1490.	1495.	1500.	1505.	1510.	1514.	1519.	1524.	1529.
5.10	1534.	1538.	1543.	1548.	1553.	1558.	1562.	1567.	1572.	1577.
5.20	1582.	1587.	1592.	1597.	1601.	1606.	1611.	1616.	1621.	1626.
5.30	1631.	1636.	1641.	1646.	1651.	1656.	1661.	1665.	1670.	1675.
5.40	1680.	1685.	1690.	1695.	1700.	1705.	1710.	1715.	1720.	1725.
5.50	1730.	1735.	1741.	1746.	1751.	1756.	1761.	1766.	1771.	1776.
5.60	1781.	1786.	1791.	1796.	1801.	1807.	1812.	1817.	1822.	1827.
5.70	1832.	1837.	1843.	1848.	1853.	1858.	1863.	1868.	1874.	1879.
5.80	1884.	1889.	1894.	1900.	1905.	1910.	1915.	1920.	1926.	1931.
5.90	1936.	1941.	1947.	1952.	1957.	1962.	1968.	1973.	1978.	1984.
6.00	1989.	1994.	2000.	2005.	2010.	2016.	2021.	2026.	2032.	2037.

Table A8-19. Free-flow discharge through 40-ft Parshall measuring flume in ft³/sec.
 Computed from the formula $Q=150.00h_a^{1.6}$.

Upper Head h_a , ft	Hundredths									
	0.00	0.01	0.02	0.03	0.04	0.05	0.06	0.07	0.08	0.09
0.30	21.9	23.0	24.2	25.5	26.7	28.0	29.3	30.6	31.9	33.3
.40	34.6	36.0	37.4	38.9	40.3	41.8	43.3	44.8	46.4	47.9
.50	49.5	51.1	52.7	54.3	56.0	57.6	59.3	61.0	62.7	64.5
.60	66.2	68.0	69.8	71.6	73.4	75.3	77.2	79.0	80.9	82.8
.70	84.8	86.7	88.7	90.7	92.7	94.7	96.7	98.7	101.	103.
.80	105.	107.	109.	111.	113.	116.	118.	120.	122.	124.
.90	127.	129.	131.	134.	136.	138.	141.	143.	145.	148.
1.00	150.	152.	155.	157.	160.	162.	165.	167.	170.	172.
1.10	175.	177.	180.	182.	185.	188.	190.	193.	195.	198.
1.20	201.	203.	206.	209.	212.	214.	217.	220.	223.	225.
1.30	228.	231.	234.	237.	240.	242.	245.	248.	251.	254.
1.40	257.	260.	263.	266.	269.	272.	275.	278.	281.	284.
1.50	287.	290.	293.	296.	299.	302.	306.	309.	312.	315.
1.60	318.	321.	325.	328.	331.	334.	337.	341.	344.	347.
1.70	351.	354.	357.	361.	364.	367.	371.	374.	377.	381.
1.80	384.	388.	391.	394.	398.	401.	405.	408.	412.	415.
1.90	419.	422.	426.	430.	433.	437.	440.	444.	447.	451.
2.00	455.	458.	462.	466.	469.	473.	477.	480.	484.	488.
2.10	492.	495.	499.	503.	507.	510.	514.	518.	522.	526.
2.20	530.	533.	537.	541.	545.	549.	553.	557.	561.	565.
2.30	569.	573.	577.	581.	585.	589.	593.	597.	601.	605.
2.40	609.	613.	617.	621.	625.	629.	633.	637.	642.	646.
2.50	650.	654.	658.	662.	667.	671.	675.	679.	683.	688.
2.60	692.	696.	700.	705.	709.	713.	718.	722.	726.	731.
2.70	735.	739.	744.	748.	752.	757.	761.	766.	770.	775.
2.80	779.	783.	788.	792.	797.	801.	806.	810.	815.	819.
2.90	824.	829.	833.	838.	842.	847.	851.	856.	861.	865.
3.00	870.	875.	879.	884.	889.	893.	898.	903.	907.	912.
3.10	917.	922.	926.	931.	936.	941.	945.	950.	955.	960.
3.20	965.	969.	974.	979.	984.	989.	994.	999.	1003.	1008.
3.30	1013.	1018.	1023.	1028.	1033.	1038.	1043.	1048.	1053.	1058.
3.40	1063.	1068.	1073.	1078.	1083.	1088.	1093.	1098.	1103.	1108.
3.50	1113.	1118.	1123.	1129.	1134.	1139.	1144.	1149.	1154.	1159.
3.60	1165.	1170.	1175.	1180.	1185.	1191.	1196.	1201.	1206.	1212.
3.70	1217.	1222.	1227.	1233.	1238.	1243.	1249.	1254.	1259.	1264.
3.80	1270.	1275.	1281.	1286.	1291.	1297.	1302.	1307.	1313.	1318.
3.90	1324.	1329.	1335.	1340.	1346.	1351.	1356.	1362.	1367.	1373.
4.00	1378.	1384.	1389.	1395.	1401.	1406.	1412.	1417.	1423.	1428.
4.10	1434.	1440.	1445.	1451.	1456.	1462.	1468.	1473.	1479.	1485.
4.20	1490.	1496.	1502.	1507.	1513.	1519.	1525.	1530.	1536.	1542.
4.30	1548.	1553.	1559.	1565.	1571.	1576.	1582.	1588.	1594.	1600.
4.40	1606.	1611.	1617.	1623.	1629.	1635.	1641.	1647.	1652.	1658.
4.50	1664.	1670.	1676.	1682.	1688.	1694.	1700.	1706.	1712.	1718.
4.60	1724.	1730.	1736.	1742.	1748.	1754.	1760.	1766.	1772.	1778.
4.70	1784.	1790.	1796.	1802.	1809.	1815.	1821.	1827.	1833.	1839.
4.80	1845.	1851.	1858.	1864.	1870.	1876.	1882.	1889.	1895.	1901.
4.90	1907.	1913.	1920.	1926.	1932.	1938.	1945.	1951.	1957.	1964.
5.00	1970.	1976.	1983.	1989.	1995.	2002.	2008.	2014.	2021.	2027.
5.10	2033.	2040.	2046.	2052.	2059.	2065.	2072.	2078.	2085.	2091.
5.20	2097.	2104.	2110.	2117.	2123.	2130.	2136.	2143.	2149.	2156.
5.30	2162.	2169.	2175.	2182.	2189.	2195.	2202.	2208.	2215.	2221.
5.40	2228.	2235.	2241.	2248.	2254.	2261.	2268.	2274.	2281.	2288.
5.50	2294.	2301.	2308.	2314.	2321.	2328.	2335.	2341.	2348.	2355.
5.60	2362.	2368.	2375.	2382.	2389.	2395.	2402.	2409.	2416.	2423.
5.70	2429.	2436.	2443.	2450.	2457.	2464.	2470.	2477.	2484.	2491.
5.80	2498.	2505.	2512.	2519.	2526.	2532.	2539.	2546.	2553.	2560.
5.90	2567.	2574.	2581.	2588.	2595.	2602.	2609.	2616.	2623.	2630.
6.00	2637.	2644.	2651.	2658.	2665.	2672.	2679.	2687.	2694.	2701.

Table A8-20. Free-flow discharge through 50-ft Parshall measuring flume in ft³/sec.
 Computed from the formula $Q=186.88h_a^{1.6}$.

Upper Head h_a , ft	Hundredths									
	0.00	0.01	0.02	0.03	0.04	0.05	0.06	0.07	0.08	0.09
0.30	27.2	28.7	30.2	31.7	33.3	34.8	36.4	38.1	39.7	41.4
.40	43.1	44.9	46.6	48.4	50.2	52.1	53.9	55.8	57.7	59.7
.50	61.6	63.6	65.6	67.7	69.7	71.8	73.9	76.0	78.2	80.3
.60	82.5	84.7	87.0	89.2	91.5	93.8	96.1	98.5	101.	103.
.70	106.	108.	110.	113.	115.	118.	120.	123.	126.	128.
.80	131.	133.	136.	139.	141.	144.	147.	150.	152.	155.
.90	158.	161.	164.	166.	169.	172.	175.	178.	181.	184.
1.00	187.	190.	193.	196.	199.	202.	205.	208.	211.	215.
1.10	218.	221.	224.	227.	230.	234.	237.	240.	244.	247.
1.20	250.	254.	257.	260.	264.	267.	270.	274.	277.	281.
1.30	284.	288.	291.	295.	298.	302.	306.	309.	313.	317.
1.40	320.	324.	328.	331.	335.	339.	342.	346.	350.	354.
1.50	358.	361.	365.	369.	373.	377.	381.	385.	389.	392.
1.60	396.	400.	404.	408.	412.	416.	420.	425.	429.	433.
1.70	437.	441.	445.	449.	453.	458.	462.	466.	470.	474.
1.80	479.	483.	487.	491.	496.	500.	504.	509.	513.	517.
1.90	522.	526.	531.	535.	540.	544.	548.	553.	557.	562.
2.00	567.	571.	576.	580.	585.	589.	594.	599.	603.	608.
2.10	613.	617.	622.	627.	631.	636.	641.	646.	650.	655.
2.20	660.	665.	669.	674.	679.	684.	689.	694.	699.	704.
2.30	708.	713.	718.	723.	728.	733.	738.	743.	748.	753.
2.40	758.	763.	769.	774.	779.	784.	789.	794.	799.	804.
2.50	810.	815.	820.	825.	830.	836.	841.	846.	851.	857.
2.60	862.	867.	873.	878.	883.	889.	894.	899.	905.	910.
2.70	916.	921.	927.	932.	937.	943.	948.	954.	959.	965.
2.80	971.	976.	982.	987.	993.	998.	1004.	1010.	1015.	1021.
2.90	1027.	1032.	1038.	1044.	1049.	1055.	1061.	1067.	1072.	1078.
3.00	1084.	1090.	1095.	1101.	1107.	1113.	1119.	1125.	1130.	1136.
3.10	1142.	1148.	1154.	1160.	1166.	1172.	1178.	1184.	1190.	1196.
3.20	1202.	1208.	1214.	1220.	1226.	1232.	1238.	1244.	1250.	1256.
3.30	1262.	1268.	1275.	1281.	1287.	1293.	1299.	1305.	1312.	1318.
3.40	1324.	1330.	1337.	1343.	1349.	1355.	1362.	1368.	1374.	1381.
3.50	1387.	1393.	1400.	1406.	1412.	1419.	1425.	1432.	1438.	1444.
3.60	1451.	1457.	1464.	1470.	1477.	1483.	1490.	1496.	1503.	1509.
3.70	1516.	1523.	1529.	1536.	1542.	1549.	1555.	1562.	1569.	1575.
3.80	1582.	1589.	1595.	1602.	1609.	1615.	1622.	1629.	1636.	1642.
3.90	1649.	1656.	1663.	1670.	1676.	1683.	1690.	1697.	1704.	1710.
4.00	1717.	1724.	1731.	1738.	1745.	1752.	1759.	1766.	1773.	1780.
4.10	1787.	1794.	1801.	1808.	1815.	1822.	1829.	1836.	1843.	1850.
4.20	1857.	1864.	1871.	1878.	1885.	1892.	1899.	1907.	1914.	1921.
4.30	1928.	1935.	1942.	1950.	1957.	1964.	1971.	1978.	1986.	1993.
4.40	2000.	2008.	2015.	2022.	2029.	2037.	2044.	2051.	2059.	2066.
4.50	2073.	2081.	2088.	2096.	2103.	2110.	2118.	2125.	2133.	2140.
4.60	2148.	2155.	2163.	2170.	2178.	2185.	2193.	2200.	2208.	2215.
4.70	2223.	2230.	2238.	2246.	2253.	2261.	2268.	2276.	2284.	2291.
4.80	2299.	2307.	2314.	2322.	2330.	2337.	2345.	2353.	2361.	2368.
4.90	2376.	2384.	2392.	2399.	2407.	2415.	2423.	2431.	2439.	2446.
5.00	2454.	2462.	2470.	2478.	2486.	2494.	2502.	2509.	2517.	2525.
5.10	2533.	2541.	2549.	2557.	2565.	2573.	2581.	2589.	2597.	2605.
5.20	2613.	2621.	2629.	2637.	2645.	2653.	2662.	2670.	2678.	2686.
5.30	2694.	2702.	2710.	2718.	2727.	2735.	2743.	2751.	2759.	2768.
5.40	2776.	2784.	2792.	2801.	2809.	2817.	2825.	2834.	2842.	2850.
5.50	2859.	2867.	2875.	2884.	2892.	2900.	2909.	2917.	2925.	2934.
5.60	2942.	2951.	2959.	2967.	2976.	2984.	2993.	3001.	3010.	3018.
5.70	3027.	3035.	3044.	3052.	3061.	3069.	3078.	3086.	3095.	3103.
5.80	3112.	3121.	3129.	3138.	3146.	3155.	3164.	3172.	3181.	3190.
5.90	3198.	3207.	3216.	3224.	3233.	3242.	3251.	3259.	3268.	3277.
6.00	3286.	3294.	3303.	3312.	3321.	3329.	3338.	3347.	3356.	3365.

Table A9-2. Discharge of fully contracted standard submerged rectangular orifice in ft³/sec. Computed from the formula $Q=0.61A(2g\Delta h)^{0.5}$

Head Δh , ft	Cross-sectional area A of orifice, square feet							
	0.25	0.5	0.75	1.0	1.25	1.5	1.75	2.0
0.01	0.122	0.245	0.367	0.490	0.612	0.734	0.857	0.979
.02	.173	.346	.519	.692	.865	1.04	1.21	1.38
.03	.212	.424	.636	.848	1.06	1.27	1.48	1.70
.04	.245	.490	.734	.979	1.22	1.47	1.71	1.96
.05	.274	.547	.821	1.09	1.37	1.64	1.92	2.19
.06	.300	.600	.899	1.20	1.50	1.80	2.10	2.40
.07	.324	.648	.971	1.30	1.62	1.94	2.27	2.59
.08	.346	.692	1.04	1.38	1.73	2.08	2.42	2.77
.09	.367	.734	1.10	1.47	1.84	2.20	2.57	2.94
.10	.387	.774	1.16	1.55	1.94	2.32	2.71	3.10
.11	.406	.812	1.22	1.62	2.03	2.44	2.84	3.25
.12	.424	.848	1.27	1.70	2.12	2.54	2.97	3.39
.13	.441	.882	1.32	1.76	2.21	2.65	3.09	3.53
.14	.458	.916	1.37	1.83	2.29	2.75	3.21	3.66
.15	.474	.948	1.42	1.90	2.37	2.84	3.32	3.79
.16	.490	.979	1.47	1.96	2.45	2.94	3.43	3.92
.17	.505	1.01	1.51	2.02	2.52	3.03	3.53	4.04
.18	.519	1.04	1.56	2.08	2.60	3.12	3.63	4.15
.19	.533	1.07	1.60	2.13	2.67	3.20	3.73	4.27
.20	.547	1.09	1.64	2.19	2.74	3.28	3.83	4.38
.21	.561	1.12	1.68	2.24	2.80	3.36	3.93	4.49
.22	.574	1.15	1.72	2.30	2.87	3.44	4.02	4.59
.23	.587	1.17	1.76	2.35	2.93	3.52	4.11	4.70
.24	.600	1.20	1.80	2.40	3.00	3.60	4.20	4.80
.25	.612	1.22	1.84	2.45	3.06	3.67	4.28	4.90
.26	.624	1.25	1.87	2.50	3.12	3.74	4.37	4.99
.27	.636	1.27	1.91	2.54	3.18	3.82	4.45	5.09
.28	.648	1.30	1.94	2.59	3.24	3.89	4.53	5.18
.29	.659	1.32	1.98	2.64	3.30	3.95	4.61	5.27
.30	.670	1.34	2.01	2.68	3.35	4.02	4.69	5.36
.31	.681	1.36	2.04	2.73	3.41	4.09	4.77	5.45
.32	.692	1.38	2.08	2.77	3.46	4.15	4.85	5.54
.33	.703	1.41	2.11	2.81	3.52	4.22	4.92	5.62
.34	.714	1.43	2.14	2.85	3.57	4.28	5.00	5.71
.35	.724	1.45	2.17	2.90	3.62	4.34	5.07	5.79
.36	.734	1.47	2.20	2.94	3.67	4.41	5.14	5.87
.37	.744	1.49	2.23	2.98	3.72	4.47	5.21	5.96
.38	.754	1.51	2.26	3.02	3.77	4.53	5.28	6.04
.39	.764	1.53	2.29	3.06	3.82	4.59	5.35	6.11
.40	.774	1.55	2.32	3.10	3.87	4.64	5.42	6.19

Table A9-2. Discharge of fully contracted standard submerged rectangular orifice in ft³/sec. Computed from the formula $Q=0.61A(2g\Delta h)^{0.5}$

Head Δh , ft	Cross-sectional area A of orifice, square feet							
	0.25	0.5	0.75	1.0	1.25	1.5	1.75	2.0
.41	0.784	1.57	2.35	3.13	3.92	4.70	5.49	6.27
.42	.793	1.59	2.38	3.17	3.97	4.76	5.55	6.34
.43	.803	1.61	2.41	3.21	4.01	4.82	5.62	6.42
.44	.812	1.62	2.44	3.25	4.06	4.87	5.68	6.49
.45	.821	1.64	2.46	3.28	4.10	4.93	5.75	6.57
.46	.830	1.66	2.49	3.32	4.15	4.98	5.81	6.64
.47	.839	1.68	2.52	3.36	4.19	5.03	5.87	6.71
.48	.848	1.70	2.54	3.39	4.24	5.09	5.94	6.78
.49	.857	1.71	2.57	3.43	4.28	5.14	6.00	6.85
.50	.865	1.73	2.60	3.46	4.33	5.19	6.06	6.92
.51	.874	1.75	2.62	3.50	4.37	5.24	6.12	6.99
.52	.882	1.76	2.65	3.53	4.41	5.29	6.18	7.06
.53	.891	1.78	2.67	3.56	4.45	5.35	6.24	7.13
.54	.899	1.80	2.70	3.60	4.50	5.40	6.30	7.19
.55	.908	1.82	2.72	3.63	4.54	5.45	6.35	7.26
.56	.916	1.83	2.75	3.66	4.58	5.49	6.41	7.33
.57	.924	1.85	2.77	3.70	4.62	5.54	6.47	7.39
.58	.932	1.86	2.80	3.73	4.66	5.59	6.52	7.46
.59	.940	1.88	2.82	3.76	4.70	5.64	6.58	7.52
.60	.948	1.90	2.84	3.79	4.74	5.69	6.64	7.58
.61	.956	1.91	2.87	3.82	4.78	5.73	6.69	7.65
.62	.964	1.93	2.89	3.85	4.82	5.78	6.75	7.71
.63	.971	1.94	2.91	3.89	4.86	5.83	6.80	7.77
.64	.979	1.96	2.94	3.92	4.90	5.87	6.85	7.83
.65	.987	1.97	2.96	3.95	4.93	5.92	6.91	7.89
.66	.994	1.99	2.98	3.98	4.97	5.97	6.96	7.95
.67	1.00	2.00	3.01	4.01	5.01	6.01	7.01	8.01
.68	1.01	2.02	3.03	4.04	5.05	6.06	7.06	8.07
.69	1.02	2.03	3.05	4.07	5.08	6.10	7.12	8.13
.70	1.02	2.05	3.07	4.10	5.12	6.14	7.17	8.19
.71	1.03	2.06	3.09	4.12	5.16	6.19	7.22	8.25
.72	1.04	2.08	3.12	4.15	5.19	6.23	7.27	8.31
.73	1.05	2.09	3.14	4.18	5.23	6.27	7.32	8.36
.74	1.05	2.11	3.16	4.21	5.26	6.32	7.37	8.42
.75	1.06	2.12	3.18	4.24	5.30	6.36	7.42	8.48
.76	1.07	2.13	3.20	4.27	5.33	6.40	7.47	8.54
.77	1.07	2.15	3.22	4.30	5.37	6.44	7.52	8.59
.78	1.08	2.16	3.24	4.32	5.40	6.49	7.57	8.65
.79	1.09	2.18	3.26	4.35	5.44	6.53	7.61	8.70
.80	1.09	2.19	3.28	4.38	5.47	6.57	7.66	8.76

Table A9-3. Discharge of rectangular submerged orifices with bottom and side contractions suppressed, in ft³/sec. Computed from the formula $Q=0.70A(2g\Delta h)^{0.5}$

Head ΔH , ft	Cross-sectional area A of orifice, square feet							
	2.0	2.5	3.0	3.5	4.0	5.0	6.0	7.0
0.04	2.25	2.81	3.37	3.93	4.49	5.62	6.74	7.86
.05	2.51	3.14	3.77	4.40	5.02	6.28	7.54	8.79
.06	2.75	3.44	4.13	4.82	5.50	6.88	8.26	9.63
.07	2.97	3.72	4.46	5.20	5.94	7.43	8.92	10.4
.08	3.18	3.97	4.77	5.56	6.36	7.94	9.53	11.1
.09	3.37	4.21	5.06	5.90	6.74	8.43	10.1	11.8
.10	3.55	4.44	5.33	6.22	7.11	8.88	10.7	12.4
.11	3.73	4.66	5.59	6.52	7.45	9.32	11.2	13.0
.12	3.89	4.86	5.84	6.81	7.78	9.73	11.7	13.6
.13	4.05	5.06	6.08	7.09	8.10	10.1	12.2	14.2
.14	4.20	5.25	6.31	7.36	8.41	10.5	12.6	14.7
.15	4.35	5.44	6.53	7.61	8.70	10.9	13.1	15.2
.16	4.49	5.62	6.74	7.86	8.99	11.2	13.5	15.7
.17	4.63	5.79	6.95	8.11	9.26	11.6	13.9	16.2
.18	4.77	5.96	7.15	8.34	9.53	11.9	14.3	16.7
.19	4.90	6.12	7.35	8.57	9.79	12.2	14.7	17.1
.20	5.02	6.28	7.54	8.79	10.0	12.6	15.1	17.6
.21	5.15	6.44	7.72	9.01	10.3	12.9	15.4	18.0
.22	5.27	6.59	7.90	9.22	10.5	13.2	15.8	18.4
.23	5.39	6.74	8.08	9.43	10.8	13.5	16.2	18.9
.24	5.50	6.88	8.26	9.63	11.0	13.8	16.5	19.3
.25	5.62	7.02	8.43	9.83	11.2	14.0	16.9	19.7
.26	5.73	7.16	8.59	10.0	11.5	14.3	17.2	20.1
.27	5.84	7.30	8.76	10.2	11.7	14.6	17.5	20.4
.28	5.94	7.43	8.92	10.4	11.9	14.9	17.8	20.8
.29	6.05	7.56	9.08	10.6	12.1	15.1	18.2	21.2
.30	6.15	7.69	9.23	10.8	12.3	15.4	18.5	21.5
.31	6.26	7.82	9.38	10.9	12.5	15.6	18.8	21.9
.32	6.36	7.94	9.53	11.1	12.7	15.9	19.1	22.2
.33	6.45	8.07	9.68	11.3	12.9	16.1	19.4	22.6
.34	6.55	8.19	9.83	11.5	13.1	16.4	19.7	22.9
.35	6.65	8.31	9.97	11.6	13.3	16.6	19.9	23.3
.36	6.74	8.43	10.1	11.8	13.5	16.9	20.2	23.6
.37	6.83	8.54	10.3	12.0	13.7	17.1	20.5	23.9
.38	6.93	8.66	10.4	12.1	13.9	17.3	20.8	24.2
.39	7.02	8.77	10.5	12.3	14.0	17.5	21.0	24.6
.40	7.11	8.88	10.7	12.4	14.2	17.8	21.3	24.9
.41	7.19	8.99	10.8	12.6	14.4	18.0	21.6	25.2
.42	7.28	9.10	10.9	12.7	14.6	18.2	21.8	25.5
.43	7.37	9.21	11.1	12.9	14.7	18.4	22.1	25.8
.44	7.45	9.32	11.2	13.0	14.9	18.6	22.4	26.1
.45	7.54	9.42	11.3	13.2	15.1	18.8	22.6	26.4
.46	7.62	9.52	11.4	13.3	15.2	19.0	22.9	26.7
.47	7.70	9.63	11.6	13.5	15.4	19.3	23.1	27.0
.48	7.78	9.73	11.7	13.6	15.6	19.5	23.4	27.2
.49	7.86	9.83	11.8	13.8	15.7	19.7	23.6	27.5
.50	7.94	9.93	11.9	13.9	15.9	19.9	23.8	27.8
.51	8.02	10.0	12.0	14.0	16.0	20.1	24.1	28.1
.52	8.10	10.1	12.2	14.2	16.2	20.3	24.3	28.4
.53	8.18	10.2	12.3	14.3	16.4	20.4	24.5	28.6

Table A9-3 [continued]. Discharge of rectangular submerged orifices with bottom and side contractions suppressed, in ft³/sec. Computed from the formula $Q=0.70A(2g\Delta h)^{0.5}$

Head $\Delta H, ft$	Cross-sectional area A of orifice, square feet						
	8.0	10.0	12.0	14.0	16.0	18.0	20.0
0.04	8.99	11.2	13.5	15.7	18.0	20.2	22.5
.05	10.0	12.6	15.1	17.6	20.1	22.6	25.1
.06	11.0	13.8	16.5	19.3	22.0	24.8	27.5
.07	11.9	14.9	17.8	20.8	23.8	26.8	29.7
.08	12.7	15.9	19.1	22.2	25.4	28.6	31.8
.09	13.5	16.9	20.2	23.6	27.0	30.3	33.7
.10	14.2	17.8	21.3	24.9	28.4	32.0	35.5
.11	14.9	18.6	22.4	26.1	29.8	33.5	37.3
.12	15.6	19.5	23.4	27.2	31.1	35.0	38.9
.13	16.2	20.3	24.3	28.4	32.4	36.5	40.5
.14	16.8	21.0	25.2	29.4	33.6	37.8	42.0
.15	17.4	21.8	26.1	30.5	34.8	39.2	43.5
.16	18.0	22.5	27.0	31.5	36.0	40.4	44.9
.17	18.5	23.2	27.8	32.4	37.1	41.7	46.3
.18	19.1	23.8	28.6	33.4	38.1	42.9	47.7
.19	19.6	24.5	29.4	34.3	39.2	44.1	49.0
.20	20.1	25.1	30.1	35.2	40.2	45.2	50.2
.21	20.6	25.7	30.9	36.0	41.2	46.3	51.5
.22	21.1	26.3	31.6	36.9	42.2	47.4	52.7
.23	21.6	26.9	32.3	37.7	43.1	48.5	53.9
.24	22.0	27.5	33.0	38.5	44.0	49.5	55.0
.25	22.5	28.1	33.7	39.3	44.9	50.6	56.2
.26	22.9	28.6	34.4	40.1	45.8	51.6	57.3
.27	23.4	29.2	35.0	40.9	46.7	52.5	58.4
.28	23.8	29.7	35.7	41.6	47.6	53.5	59.4
.29	24.2	30.3	36.3	42.4	48.4	54.5	60.5
.30	24.6	30.8	36.9	43.1	49.2	55.4	61.5
.31	25.0	31.3	37.5	43.8	50.0	56.3	62.6
.32	25.4	31.8	38.1	44.5	50.8	57.2	63.6
.33	25.8	32.3	38.7	45.2	51.6	58.1	64.5
.34	26.2	32.8	39.3	45.9	52.4	59.0	65.5
.35	26.6	33.2	39.9	46.5	53.2	59.8	66.5
.36	27.0	33.7	40.4	47.2	53.9	60.7	67.4
.37	27.3	34.2	41.0	47.8	54.7	61.5	68.3
.38	27.7	34.6	41.6	48.5	55.4	62.3	69.3
.39	28.1	35.1	42.1	49.1	56.1	63.1	70.2
.40	28.4	35.5	42.6	49.7	56.8	64.0	71.1
.41	28.8	36.0	43.2	50.4	57.6	64.7	71.9
.42	29.1	36.4	43.7	51.0	58.2	65.5	72.8
.43	29.5	36.8	44.2	51.6	58.9	66.3	73.7
.44	29.8	37.3	44.7	52.2	59.6	67.1	74.5
.45	30.1	37.7	45.2	52.8	60.3	67.8	75.4
.46	30.5	38.1	45.7	53.3	61.0	68.6	76.2
.47	30.8	38.5	46.2	53.9	61.6	69.3	77.0
.48	31.1	38.9	46.7	54.5	62.3	70.1	77.8
.49	31.5	39.3	47.2	55.1	62.9	70.8	78.6
.50	31.8	39.7	47.7	55.6	63.6	71.5	79.4
.51	32.1	40.1	48.1	56.2	64.2	72.2	80.2
.52	32.4	40.5	48.6	56.7	64.8	72.9	81.0
.53	32.7	40.9	49.1	57.3	65.4	73.6	81.8

Table A9-3 [continued]. Discharge of rectangular submerged orifices with bottom and side contractions suppressed, in ft³/sec. Computed from the formula $Q=0.70A(2g\Delta h)^{0.5}$

Head ΔH , ft	Cross-sectional area A of orifice, square feet							
	22	24	26	28	30	32	34	36
0.04	24.7	27.0	29.2	31.5	33.7	36.0	38.2	40.4
.05	27.6	30.1	32.7	35.2	37.7	40.2	42.7	45.2
.06	30.3	33.0	35.8	38.5	41.3	44.0	46.8	49.5
.07	32.7	35.7	38.6	41.6	44.6	47.6	50.5	53.5
.08	35.0	38.1	41.3	44.5	47.7	50.8	54.0	57.2
.09	37.1	40.4	43.8	47.2	50.6	53.9	57.3	60.7
.10	39.1	42.6	46.2	49.7	53.3	56.8	60.4	64.0
.11	41.0	44.7	48.4	52.2	55.9	59.6	63.3	67.1
.12	42.8	46.7	50.6	54.5	58.4	62.3	66.2	70.1
.13	44.6	48.6	52.7	56.7	60.8	64.8	68.9	72.9
.14	46.2	50.4	54.6	58.9	63.1	67.3	71.5	75.7
.15	47.9	52.2	56.6	60.9	65.3	69.6	74.0	78.3
.16	49.4	53.9	58.4	62.9	67.4	71.9	76.4	80.9
.17	51.0	55.6	60.2	64.9	69.5	74.1	78.7	83.4
.18	52.4	57.2	62.0	66.7	71.5	76.3	81.0	85.8
.19	53.9	58.8	63.7	68.6	73.5	78.4	83.3	88.1
.20	55.3	60.3	65.3	70.3	75.4	80.4	85.4	90.4
.21	56.6	61.8	66.9	72.1	77.2	82.4	87.5	92.7
.22	58.0	63.2	68.5	73.8	79.0	84.3	89.6	94.9
.23	59.3	64.7	70.0	75.4	80.8	86.2	91.6	97.0
.24	60.5	66.0	71.6	77.1	82.6	88.1	93.6	99.1
.25	61.8	67.4	73.0	78.6	84.3	89.9	95.5	101.
.26	63.0	68.7	74.5	80.2	85.9	91.7	97.4	103.
.27	64.2	70.1	75.9	81.7	87.6	93.4	99.2	105.
.28	65.4	71.3	77.3	83.2	89.2	95.1	101.	107.
.29	66.6	72.6	78.7	84.7	90.8	96.8	103.	109.
.30	67.7	73.8	80.0	86.2	92.3	98.5	105.	111.
.31	68.8	75.1	81.3	87.6	93.8	100.	106.	113.
.32	69.9	76.3	82.6	89.0	95.3	102.	108.	114.
.33	71.0	77.4	83.9	90.4	96.8	103.	110.	116.
.34	72.1	78.6	85.2	91.7	98.3	105.	111.	118.
.35	73.1	79.8	86.4	93.1	99.7	106.	113.	120.
.36	74.2	80.9	87.6	94.4	101.	108.	115.	121.
.37	75.2	82.0	88.8	95.7	103.	109.	116.	123.
.38	76.2	83.1	90.0	97.0	104.	111.	118.	125.
.39	77.2	84.2	91.2	98.2	105.	112.	119.	126.
.40	78.2	85.3	92.4	99.5	107.	114.	121.	128.
.41	79.1	86.3	93.5	101.	108.	115.	122.	129.
.42	80.1	87.4	94.7	102.	109.	116.	124.	131.
.43	81.0	88.4	95.8	103.	111.	118.	125.	133.
.44	82.0	89.4	96.9	104.	112.	119.	127.	134.
.45	82.9	90.4	98.0	106.	113.	121.	128.	136.
.46	83.8	91.4	99.1	107.	114.	122.	130.	137.
.47	84.7	92.4	100.	108.	116.	123.	131.	139.
.48	85.6	93.4	101.	109.	117.	125.	132.	140.
.49	86.5	94.4	102.	110.	118.	126.	134.	142.
.50	87.4	95.3	103.	111.	119.	127.	135.	143.
.51	88.3	96.3	104.	112.	120.	128.	136.	144.
.52	89.1	97.2	105.	113.	122.	130.	138.	146.
.53	90.0	98.1	106.	115.	123.	131.	139.	147.

Table A9-3 [continued]. Discharge of rectangular submerged orifices with bottom and side contractions suppressed, in ft³/sec. Computed from the formula $Q=0.70A(2g\Delta h)^{0.5}$

Head $\Delta H, ft$	Cross-sectional area A of orifice, square feet						
	38	40	42	44	46	48	50
0.04	42.7	44.9	47.2	49.4	51.7	53.9	56.2
.05	47.7	50.2	52.8	55.3	57.8	60.3	62.8
.06	52.3	55.0	57.8	60.5	63.3	66.0	68.8
.07	56.5	59.4	62.4	65.4	68.4	71.3	74.3
.08	60.4	63.6	66.7	69.9	73.1	76.3	79.4
.09	64.0	67.4	70.8	74.2	77.5	80.9	84.3
.10	67.5	71.1	74.6	78.2	81.7	85.3	88.8
.11	70.8	74.5	78.3	82.0	85.7	89.4	93.2
.12	73.9	77.8	81.7	85.6	89.5	93.4	97.3
.13	77.0	81.0	85.1	89.1	93.2	97.2	101.
.14	79.9	84.1	88.3	92.5	96.7	101.	105.
.15	82.7	87.0	91.4	95.7	100.	104.	109.
.16	85.4	89.9	94.4	98.9	103.	108.	112.
.17	88.0	92.6	97.3	102.	107.	111.	116.
.18	90.6	95.3	100.	105.	110.	114.	119.
.19	93.0	97.9	103.	108.	113.	118.	122.
.20	95.5	100.	106.	111.	116.	121.	126.
.21	97.8	103.	108.	113.	118.	124.	129.
.22	100.	105.	111.	116.	121.	126.	132.
.23	102.	108.	113.	119.	124.	129.	135.
.24	105.	110.	116.	121.	127.	132.	138.
.25	107.	112.	118.	124.	129.	135.	140.
.26	109.	115.	120.	126.	132.	137.	143.
.27	111.	117.	123.	128.	134.	140.	146.
.28	113.	119.	125.	131.	137.	143.	149.
.29	115.	121.	127.	133.	139.	145.	151.
.30	117.	123.	129.	135.	142.	148.	154.
.31	119.	125.	131.	138.	144.	150.	156.
.32	121.	127.	133.	140.	146.	153.	159.
.33	123.	129.	136.	142.	148.	155.	161.
.34	124.	131.	138.	144.	151.	157.	164.
.35	126.	133.	140.	146.	153.	160.	166.
.36	128.	135.	142.	148.	155.	162.	169.
.37	130.	137.	144.	150.	157.	164.	171.
.38	132.	139.	145.	152.	159.	166.	173.
.39	133.	140.	147.	154.	161.	168.	175.
.40	135.	142.	149.	156.	163.	171.	178.
.41	137.	144.	151.	158.	165.	173.	180.
.42	138.	146.	153.	160.	167.	175.	182.
.43	140.	147.	155.	162.	169.	177.	184.
.44	142.	149.	157.	164.	171.	179.	186.
.45	143.	151.	158.	166.	173.	181.	188.
.46	145.	152.	160.	168.	175.	183.	190.
.47	146.	154.	162.	169.	177.	185.	193.
.48	148.	156.	163.	171.	179.	187.	195.
.49	149.	157.	165.	173.	181.	189.	197.
.50	151.	159.	167.	175.	183.	191.	199.
.51	152.	160.	168.	177.	185.	193.	201.
.52	154.	162.	170.	178.	186.	194.	203.
.53	155.	164.	172.	180.	188.	196.	204.

Table A9-3 [continued]. Discharge of rectangular submerged orifices with bottom and side contractions suppressed, in ft³/sec. Computed from the formula $Q=0.70A(2g\Delta h)^{0.5}$

Head ΔH , ft	Cross-sectional area A of orifice, square feet							
	55	60	65	70	75	80	85	90
0.04	61.8	67.4	73.0	78.6	84.3	89.9	95.5	101.
.05	69.1	75.4	81.6	87.9	94.2	100.	107.	113.
.06	75.7	82.6	89.4	96.3	103.	110.	117.	124.
.07	81.7	89.2	96.6	104.	111.	119.	126.	134.
.08	87.4	95.3	103.	111.	119.	127.	135.	143.
.09	92.7	101.	110.	118.	126.	135.	143.	152.
.10	97.7	107.	115.	124.	133.	142.	151.	160.
.11	102.	112.	121.	130.	140.	149.	158.	168.
.12	107.	117.	126.	136.	146.	156.	165.	175.
.13	111.	122.	132.	142.	152.	162.	172.	182.
.14	116.	126.	137.	147.	158.	168.	179.	189.
.15	120.	131.	141.	152.	163.	174.	185.	196.
.16	124.	135.	146.	157.	169.	180.	191.	202.
.17	127.	139.	151.	162.	174.	185.	197.	208.
.18	131.	143.	155.	167.	179.	191.	203.	214.
.19	135.	147.	159.	171.	184.	196.	208.	220.
.20	138.	151.	163.	176.	188.	201.	214.	226.
.21	142.	154.	167.	180.	193.	206.	219.	232.
.22	145.	158.	171.	184.	198.	211.	224.	237.
.23	148.	162.	175.	189.	202.	216.	229.	242.
.24	151.	165.	179.	193.	206.	220.	234.	248.
.25	154.	169.	183.	197.	211.	225.	239.	253.
.26	158.	172.	186.	201.	215.	229.	243.	258.
.27	161.	175.	190.	204.	219.	234.	248.	263.
.28	163.	178.	193.	208.	223.	238.	253.	268.
.29	166.	182.	197.	212.	227.	242.	257.	272.
.30	169.	185.	200.	215.	231.	246.	262.	277.
.31	172.	188.	203.	219.	235.	250.	266.	281.
.32	175.	191.	207.	222.	238.	254.	270.	286.
.33	177.	194.	210.	226.	242.	258.	274.	290.
.34	180.	197.	213.	229.	246.	262.	278.	295.
.35	183.	199.	216.	233.	249.	266.	282.	299.
.36	185.	202.	219.	236.	253.	270.	286.	303.
.37	188.	205.	222.	239.	256.	273.	290.	308.
.38	190.	208.	225.	242.	260.	277.	294.	312.
.39	193.	210.	228.	246.	263.	281.	298.	316.
.40	195.	213.	231.	249.	266.	284.	302.	320.
.41	198.	216.	234.	252.	270.	288.	306.	324.
.42	200.	218.	237.	255.	273.	291.	309.	328.
.43	203.	221.	239.	258.	276.	295.	313.	332.
.44	205.	224.	242.	261.	279.	298.	317.	335.
.45	207.	226.	245.	264.	283.	301.	320.	339.
.46	210.	229.	248.	267.	286.	305.	324.	343.
.47	212.	231.	250.	270.	289.	308.	327.	347.
.48	214.	234.	253.	272.	292.	311.	331.	350.
.49	216.	236.	256.	275.	295.	315.	334.	354.
.50	218.	238.	258.	278.	298.	318.	338.	357.
.51	221.	241.	261.	281.	301.	321.	341.	361.
.52	223.	243.	263.	284.	304.	324.	344.	365.
.53	225.	245.	266.	286.	307.	327.	348.	368.

Table A9-3 [continued]. Discharge of rectangular submerged orifices with bottom and side contractions suppressed, in ft³/sec. Computed from the formula $Q=0.70A(2g\Delta h)^{0.5}$

Head $\Delta H, ft$	Cross-sectional area A of orifice, square feet						
	95	100	105	110	115	120	125
0.04	107	112	118	124	129	135	140
.05	119	126	132	138	144	151	157
.06	131	138	144	151	158	165	172
.07	141	149	156	163	171	178	186
.08	151	159	167	175	183	191	199
.09	160	169	177	185	194	202	211
.10	169	178	187	195	204	213	222
.11	177	186	196	205	214	224	233
.12	185	195	204	214	224	234	243
.13	192	203	213	223	233	243	253
.14	200	210	221	231	242	252	263
.15	207	218	228	239	250	261	272
.16	213	225	236	247	258	270	281
.17	220	232	243	255	266	278	290
.18	226	238	250	262	274	286	298
.19	233	245	257	269	282	294	306
.20	239	251	264	276	289	301	314
.21	245	257	270	283	296	309	322
.22	250	263	277	290	303	316	329
.23	256	269	283	296	310	323	337
.24	261	275	289	303	316	330	344
.25	267	281	295	309	323	337	351
.26	272	286	301	315	329	344	358
.27	277	292	306	321	336	350	365
.28	282	297	312	327	342	357	372
.29	287	303	318	333	348	363	378
.30	292	308	323	338	354	369	385
.31	297	313	328	344	360	375	391
.32	302	318	334	350	365	381	397
.33	307	323	339	355	371	387	403
.34	311	328	344	360	377	393	409
.35	316	332	349	366	382	399	415
.36	320	337	354	371	388	404	421
.37	325	342	359	376	393	410	427
.38	329	346	364	381	398	416	433
.39	333	351	368	386	403	421	439
.40	338	355	373	391	409	426	444
.41	342	360	378	396	414	432	450
.42	346	364	382	400	419	437	455
.43	350	368	387	405	424	442	460
.44	354	373	391	410	429	447	466
.45	358	377	396	415	433	452	471
.46	362	381	400	419	438	457	476
.47	366	385	404	424	443	462	481
.48	370	389	409	428	448	467	486
.49	374	393	413	433	452	472	492
.50	377	397	417	437	457	477	497
.51	381	401	421	441	461	481	501
.52	385	405	425	446	466	486	506
.53	389	409	429	450	470	491	511

Table A9-4. Discharge of constant-head orifice (CHO) turnout in ft³/sec.
Capacity is 20 ft³/sec, gate size is 30 by 24 inches, $\Delta h=0.20$ feet.

Discharge ft ³ /sec	Gate opening in feet		Discharge ft ³ /sec	Gate opening in feet	
	2 gates	1 gate		2 gates	1 gate
0.25	0.02	0.04	10.25	0.81	----
.50	.04	.08	10.50	.83	----
.75	.06	.12	10.75	.85	----
1.00	.08	.16	11.00	.87	----
1.25	.10	.20	11.25	.89	----
1.50	.12	.24	11.50	.91	----
1.75	.14	.28	11.75	.93	----
2.00	.16	.32	12.00	.95	----
2.25	.18	.36	12.25	.97	----
2.50	.20	.40	12.50	.99	----
2.75	.22	.44	12.75	1.01	----
3.00	.24	.48	13.00	1.03	----
3.25	.26	.52	13.25	1.05	----
3.50	.28	.56	13.50	1.07	----
3.75	.30	.60	13.75	1.085	----
4.00	.32	.64	14.00	1.10	----
4.25	.34	.68	14.25	1.12	----
4.50	.36	.72	14.50	1.14	----
4.75	.38	.755	14.75	1.16	----
5.00	.40	.79	15.00	1.18	----
5.25	.42	.83	15.25	1.20	----
5.50	.44	.87	15.50	1.22	----
5.75	.46	.91	15.75	1.24	----
6.00	.48	.95	16.00	1.26	----
6.25	.50	.99	16.25	1.28	----
6.50	.52	1.03	16.50	1.30	----
6.75	.54	1.065	16.75	1.32	----
7.00	.56	1.10	17.00	1.34	----
7.25	.58	1.14	17.25	1.355	----
7.50	.60	1.18	17.50	1.37	----
7.75	.62	1.22	17.75	1.39	----
8.00	.64	1.26	18.00	1.41	----
8.25	.66	1.30	18.25	1.43	----
8.50	.68	1.34	18.50	1.45	----
8.75	.70	1.375	18.75	1.47	----
9.00	.72	1.41	19.00	1.49	----
9.25	.74	1.45	19.25	1.51	----
9.50	.76	1.49	19.50	1.53	----
9.75	.775	1.525	19.75	1.545	----
10.00	.80	1.56	20.00	1.56	----

Table A9-5. Discharge of constant-head orifice (CHO) turnout in ft³/sec. Capacity is 10 ft³/sec, gate size is 24 by 18 inches, $\Delta h=0.20$ feet.

Discharge ft ³ /sec	Gate opening in feet		Discharge ft ³ /sec	Gate opening in feet	
	2 gates	1 gate		2 gates	1 gate
0.25	0.025	0.05	5.25	0.525	-----
.50	.05	.10	5.50	.55	-----
.75	.075	.15	5.75	.575	-----
1.00	.10	.20	6.00	.60	-----
1.25	.125	.25	6.25	.625	-----
1.50	.15	.30	6.50	.65	-----
1.75	.175	.35	6.75	.675	-----
2.00	.20	.40	7.00	.70	-----
2.25	.225	.45	7.25	.722	-----
2.50	.25	.50	7.50	.74	-----
2.75	.275	.55	7.75	.765	-----
3.00	.30	.60	8.00	.79	-----
3.25	.325	.65	8.25	.815	-----
3.50	.35	.70	8.50	.84	-----
3.75	.375	.745	8.75	.865	-----
4.00	.40	.79	9.00	.89	-----
4.25	.425	.84	9.25	.915	-----
4.50	.45	.89	9.50	.94	-----
4.75	.475	.94	9.75	.965	-----
5.00	.50	.99	10.00	.99	-----

